

60A 100V N-channel Enhancement Mode Power MOSFET

1 Description

These silicon N-channel Enhanced VDMOSFETs, is obtained by the self-aligned planar technology which reduce the conduction loss, improve switching performance and enhance the avalanche energy. Which accords with the RoHS standard.

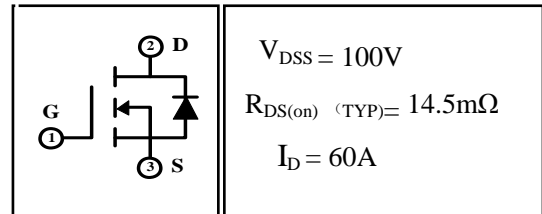

2 Features

- Lead free and Green Device Available
- Low Rds-on to Minimize Conductive Loss
- High avalanche Current
- 100% Single Pulse Avalanche Energy Test
- 100% ΔV_{DS} Test

3 Applications

- Power Supply
- DC-DC Converters
- Full Bridge Control



4 Electrical Characteristics

4.1 Absolute Maximum Rating (Tc=25°C, unless otherwise noted)

Parameter	Symbol	Value	Units	
Maximum Drain-Source DC Voltage	V_{DS}	100	V	
Maximum Gate-Drain Voltage	V_{GS}	± 20	V	
Drain Current(continuous)	I_D (T=25°C) (T=100°C) (T=125°C)	47	A	
		33		
		160		
Avalanche current	I_{AS}	34	A	
Single Pulse Avalanche Energy ^(Note 1)	E_{AS}	173	mJ	
Total Dissipation	$T_a=25^\circ C$	P_{tot}	2	W
	$T_C=25^\circ C$	P_{tot}	115	W
Junction Temperature	T_j	175	°C	
Storage Temperature	T_{stg}	-55~175	°C	

4.2 Thermal Characteristics

Parameter	Symbol	Value	Unit
Thermal Resistance Junction to Case-sink	R_{thJC}	1.30	°C/W
Thermal Resistance Junction to Ambient	R_{thJA}	62.5	°C/W

4.3 Electrical Characteristics($T_c=25^\circ\text{C}$, unless otherwise noted)

Parameter	Symbol	Test Condition	Value			Units
			Min	Typ	Max	
Off Characteristics						
Drain-source Breakdown Voltage	BV_{DSS}	$I_D=250\mu\text{A}, V_{GS}=0\text{V}$	100	--	--	V
Drain-to-Source Leakage Current	I_{DSS}	$V_{DS}=80\text{V}, V_{GS}=0\text{V}, T_c=25^\circ\text{C}$	--	--	1	μA
		$V_{DS}=80\text{V}, V_{GS}=0\text{V}, T_c=125^\circ\text{C}$	--	--	100	μA
Gate-to-Source Forward Leakage	I_{GSSF}	$V_{GS}=+20\text{V}$	--	--	100	nA
Gate-to-Source Reverse Leakage	I_{GSSR}	$V_{GS}=-20\text{V}$	--	--	-100	nA
On Characteristics ^(Note 5)						
Gate Threshold Voltage	$V_{GS(th)}$	$V_{DS}=V_{GS}, I_D=250\mu\text{A}$	2	2.8	4	V
Drain-source on Resistance	$R_{DS(on)}$	$V_{GS}=10\text{V}, I_D=20\text{A}$	--	14.5	1.6	m Ω
Dynamic Characteristics ^(Note 6)						
Input Capacitance	C_{iss}	$V_{GS}=0\text{V}, V_{DS}=25\text{V}, f=1.0\text{MHz}$	--	4470	--	pF
Output Capacitance	C_{oss}		--	290	--	
Reverse Transfer Capacitance	C_{rss}		--	191	--	
Switching Characteristics ^(note6)						
Turn-on Delay Time	$t_{d(on)}$	$I_D=20\text{A}, V_{DD}=50\text{V}, R_G=6.8\Omega, V_{GS}=10\text{V}$	--	25	--	nS
Turn-on Rise Time	t_r		--	130	--	nS
Turn-off Delay Time	$t_{d(off)}$		--	61	--	nS
Turn-off Fall Time	t_f		--	120	--	nS
Total Gate Charge	Q_g	$I_D=20\text{A}, V_{DD}=50\text{V}, V_{GS}=10\text{V}$	--	86	--	nC
Gate-to-Source Charge	Q_{gs}		--	19	--	
Gate-to-Drain("Miller") Charge	Q_{gd}		--	27	--	
Drain-Source Diode Characteristics						
Diode Forward Voltage (Note 3)	V_{FSD}	$V_{GS}=0\text{V}, I_S=20\text{A}$	--	--	1.3	V
Diode Forward Current (Note 2)	I_S		--	--	20	A
Reverse Recovery Time	t_{rr}	$T_J=25^\circ\text{C}, I_S=20\text{A},$	--	82	--	nS

Reverse Recovery Charge	Q_{rr}	$dI_i/dt=100A/\mu S, V_{GS}=0V$	--	201	--	μC

Notes:

1. $L=0.3mH, I_{AS}=34A$, Start $T_j=25^\circ C$.
2. $I_{SD}=60A, di/dt \leq 100A/\mu s, V_{DD} \leq BV_{DSS}$, Start $T_j=25^\circ C$.
- 3: Repetitive rating, pulse width limited by maximum junction temperature.
- 4: Surface mounted on FR4 Board, $t \leq 10sec$.
- 5: Pulse width $\leq 300\mu s$, duty cycle $\leq 2\%$.
- 6: Guaranteed by design, not subject to production.

5 Typical characteristics diagrams

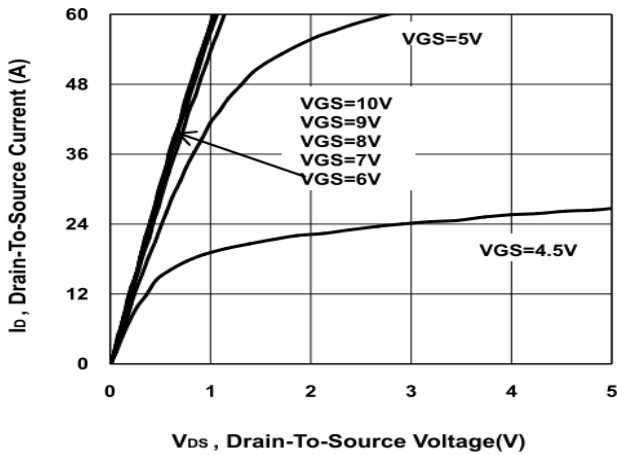

Fig 1. Output Characteristics

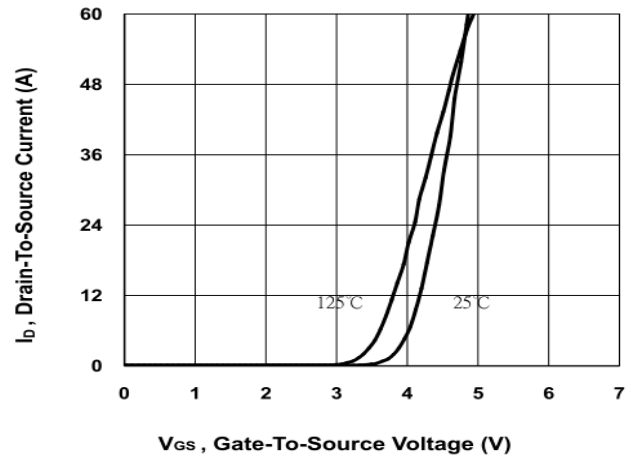

Fig 2. Transfer Characteristics

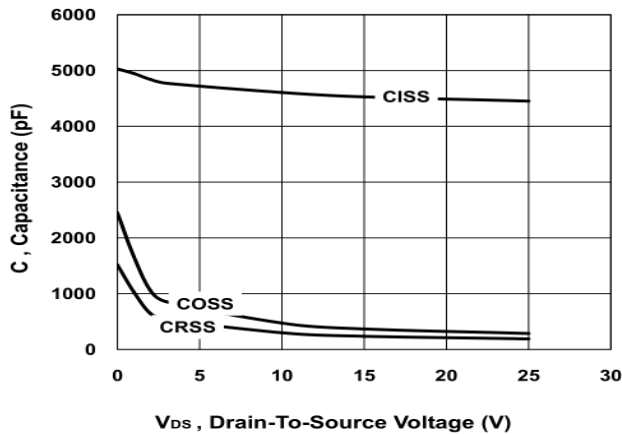

Fig 3. Capacitance Characteristic

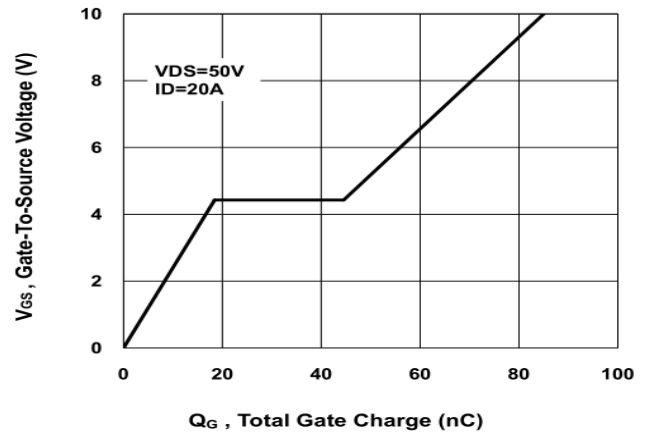

Fig 4. Gate charge Characteristics

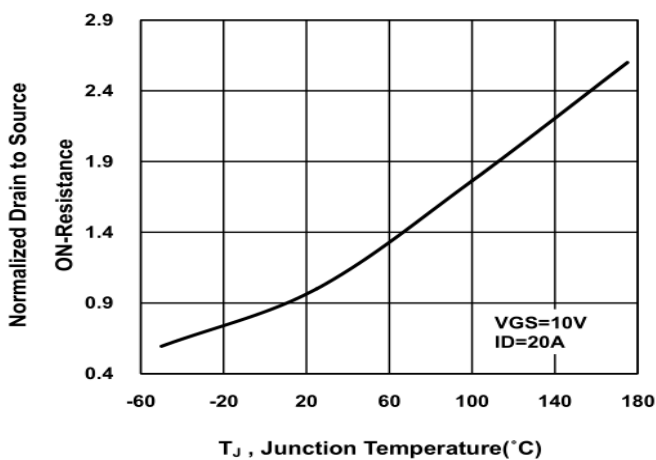

Fig 5. Normalized On-Resistance VS Temperature

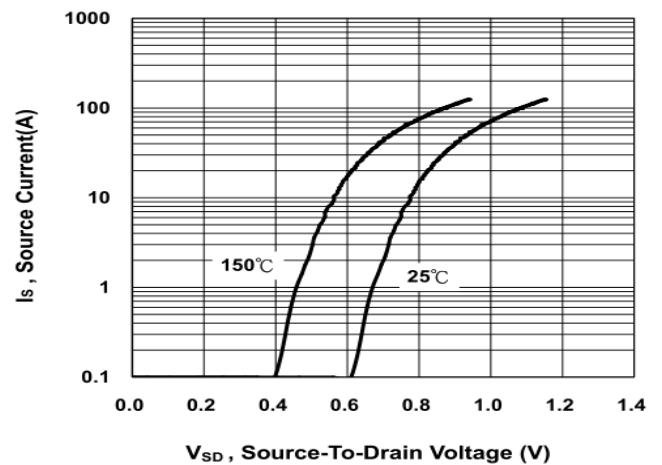
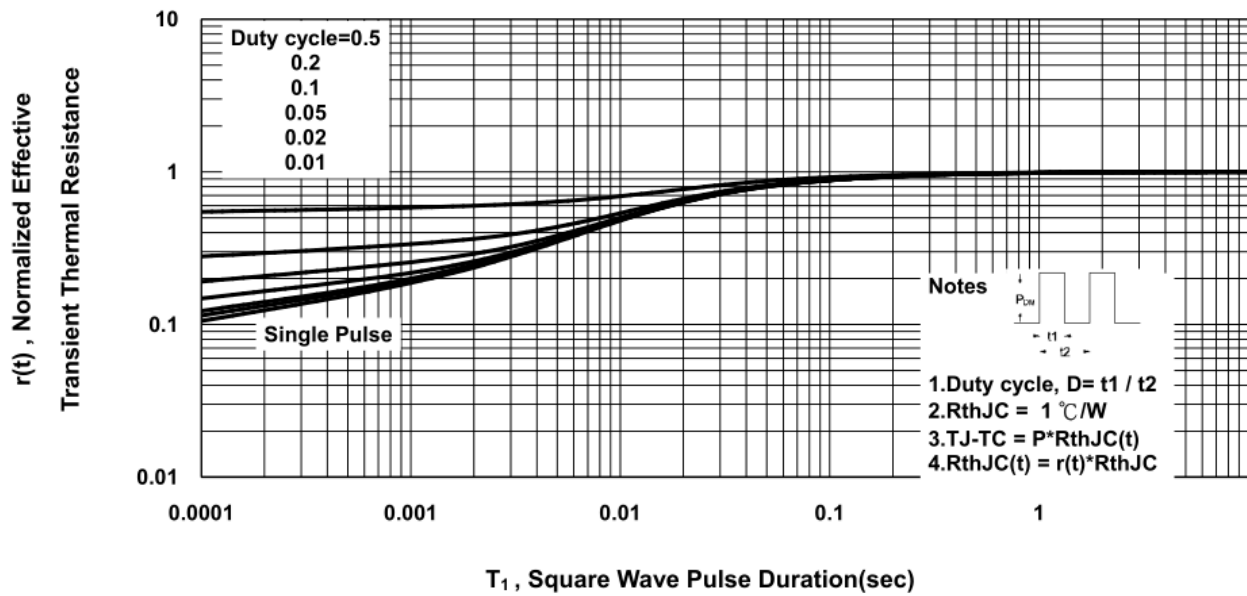
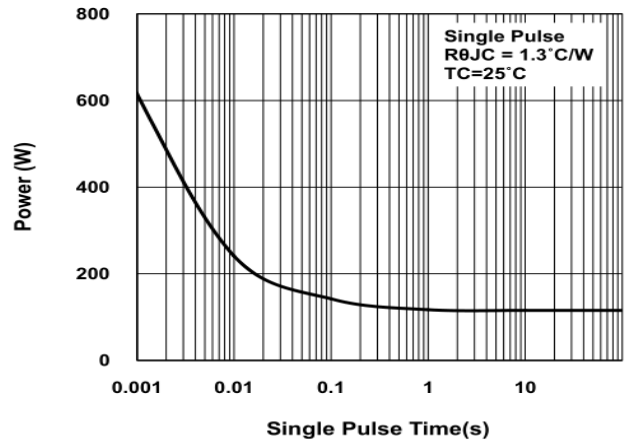
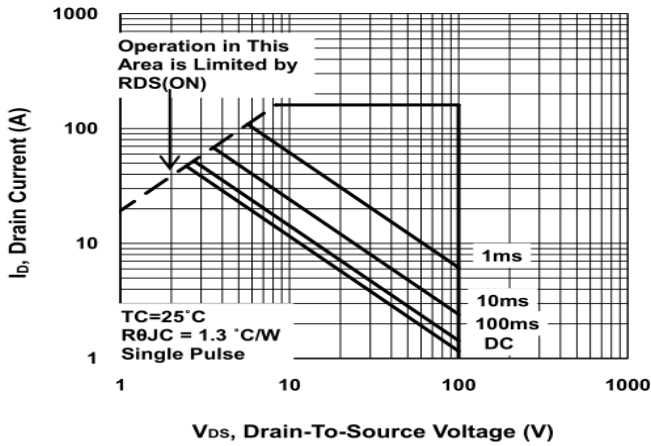
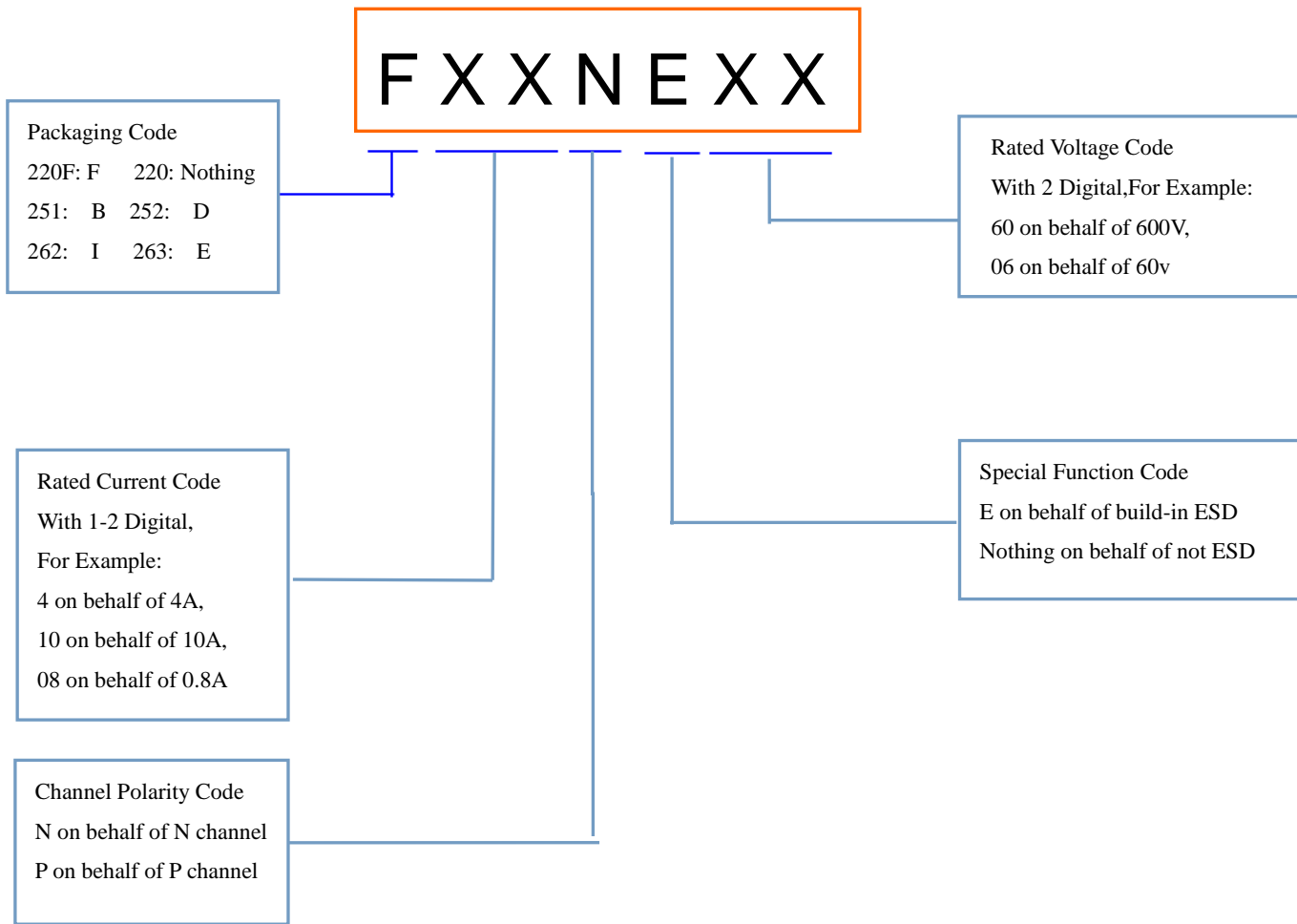

Fig 6. Source-Drain Diode Forward Voltage

5 Typical characteristics diagrams(continues)



6 Product Names Rules



7 Product Specifications and Packaging Models

Product Model	Package Type	Mark Name	RoHS	Package	Quantity
60N10	TO-220C	60N10	Pb-free	Tube	1000/box
F60N10	TO-220F	F60N10	Pb-free	Tube	1000/box
B60N10	TO-251	B60N10	Pb-free	Tube	1000/box
D60N10	TO-252	D60N10	Pb-free	Tape & Reel	3000/box
I60N10	TO-262	I60N10	Pb-free	Tube	1000/box
E60N10	TO-263	E60N10	Pb-free	Tape & Reel	800/box

8 Dimensions(continues)

TO-220F PACKAGE OUTLINE DIMENSIONS

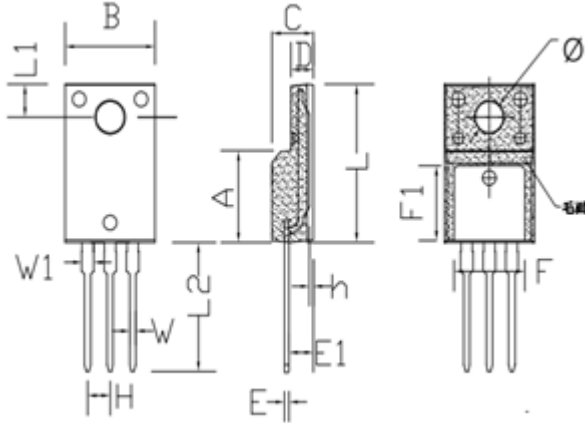

Symbol	Dimensions In Millimeters		Dimensions In Inches	
	min.	max.	min.	max.
A	8.80	9.30	0.346	0.366
B	10.00	10.50	0.394	0.413
C	4.30	4.90	0.169	0.193
D	2.30	2.70	0.091	0.106
L	15.55	16.15	0.612	0.636
h	0.40	0.60	0.016	0.024
L1	3.15	3.55	0.124	0.140
L2	12.65	13.35	0.498	0.526
W	0.70	0.90	0.028	0.035
W1	1.15	1.55	0.045	0.061
H	2.54 TYP		0.100 TYP	
E	0.48	0.53	0.019	0.021
ϕ	2.90	3.40	0.114	0.134
E1	2.40	2.90	0.094	0.114
F	7.75	8.25	0.305	0.325
F1	7.35	7.85	0.289	0.309

TO-220C PACKAGE OUTLINE DIMENSIONS

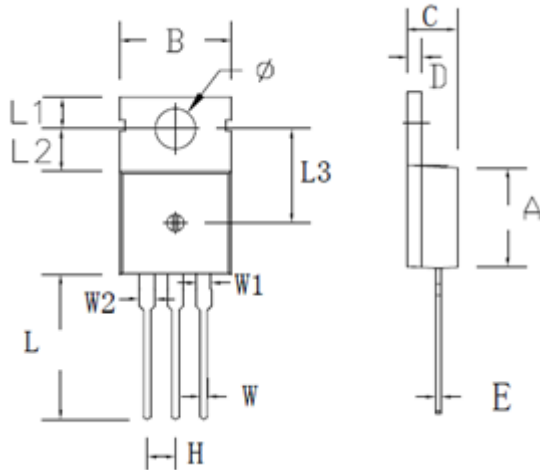

Symbol	Dimensions In Millimeters		Dimensions In Inches	
	min.	max.	min.	max.
A	8.80	9.30	0.346	0.366
B	9.70	10.30	0.382	0.406
C	4.25	4.75	0.167	0.187
D	1.20	1.45	0.047	0.057
E	0.40	0.60	0.016	0.024
H	2.54 TYP		0.100 TYP	
W	0.60	0.95	0.024	0.037
W1	1.05	1.45	0.041	0.057
W2	1.20	1.60	0.047	0.063
L	12.60	13.40	0.496	0.528
L1	2.45	2.95	0.096	0.116
L2	3.45	3.95	0.136	0.156
L3	8.15	8.65	0.321	0.341
ϕ	3.50	3.90	0.138	0.154

8 Dimensions(continues)

TO-251B PACKAGE OUTLINE DIMENSIONS

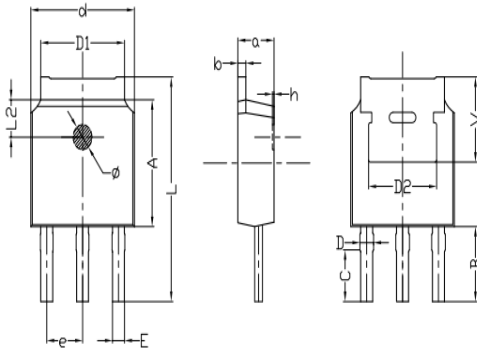

Symbol	Dimensions In Millimeters		Dimensions In Inches	
	min.	max.	min.	max.
a	2.20	2.40	0.087	0.0946
b	0.46	0.58	0.018	0.023
C	2.45	2.65	0.097	0.104
D	0.80	0.90	0.032	0.035
d	6.30	6.70	0.248	0.264
D1	5.00	5.50	0.197	0.217
D2	TYP 4.83		TYP 0.190	
A	5.80	6.20	0.228	0.244
e	2.19	2.39	0.086	0.094
L	10.40	11.00	0.4098	0.4334
B	3.50	3.70	0.1379	0.1458
L2	1.5	1.8	0.059	0.071
φ	1.10	1.30	0.0433	0.0512
h	0.00	0.30	0.000	0.012
V	5.25	5.85	0.207	0.230
E	0.60	0.80	0.0236	0.0315

TO-252B PACKAGE OUTLINE DIMENSIONS

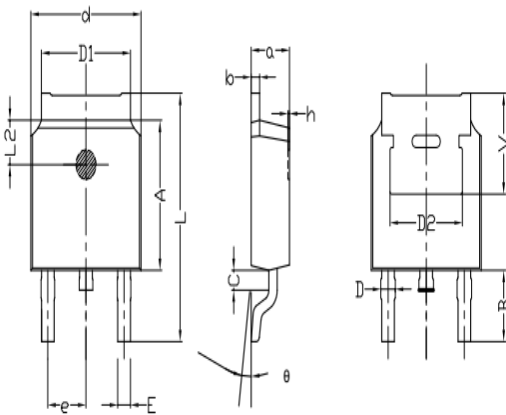

Symbol	Dimensions In Millimeters		Dimensions In Inches	
	min.	max.	min.	max.
a	2.20	2.40	0.087	0.095
b	0.46	0.58	0.018	0.023
c	0.70	0.90	0.028	0.035
D	0.80	1.00	0.032	0.039
d	6.30	6.70	0.248	0.264
D1	5.00	5.50	0.197	0.217
D2	TYP 4.83		TYP 0.190	
A	5.80	6.20	0.228	0.244
e	2.19	2.39	0.086	0.094
L	9.40	10.40	0.370	0.409
B	2.6	3.2	0.102	0.126
L2	1.5	1.8	0.059	0.071
θ	0	8	0	8
h	0	0.3	0	0.012
V	5.25	5.85	0.207	0.230

9 Attentions

- ROUM Semiconductor Technology CO.,LTD. reserves the right to change the specification without prior notice! The customer should obtain the latest version of the information before making the order and verify that the information is complete and up to date.
- It is the responsibility of the purchaser for any failure or failure of any semiconductor product under certain conditions. It is the responsibility of the purchaser to comply with safety standards and to take safety measures in the system design and machine manufacturing of Roma products in order to avoid potential risk of failure. Injury or property damage.
- Product promotion is endless, our company will be dedicated to provide customers with better products.

10 Appendix

Revision history:

Date	REV.	Description	Page
2017.04.10	1.0	Original	