

HIGH SPEED COUPLER

6N137 INFRARED LED+ PHOTO IC

The 6N137 consists of a high emitting diode and a one chip photo IC. This unit is an 8-lead DIP package.

APPLICATIONS

- DIGITAL LOGIC ISOLATION
- TELE-COMMUNICATIONS
- ANALOG DATA EQUIPMENT CONTROL

FEATURES

- LSTTL/TTL compatible: 5V Supply.
- Ultra high speed: 75nS.
- Guaranteed performance over temperature.
- High isolation voltage: 2500Vrms.
- UL recognized.

T-41-81

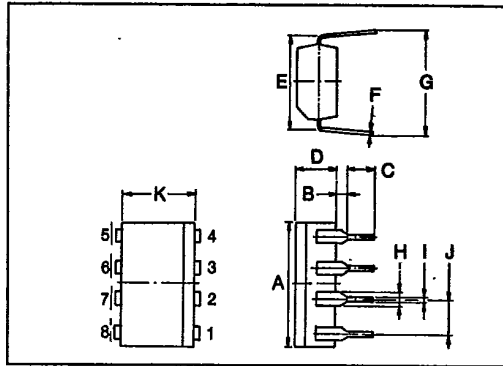

1. NO CONNECTION
2. LED ANODE
3. LED CATHODE
4. NO CONNECTION
5. GND
6. OUTPUT (OPEN COLLECTOR)
7. ENABLE
8. VCC

| SYMBOL | INCHES | MM |
|--------|---------------|-------------|
| A | 0.380 ± 0.010 | 9.66 ± 0.25 |
| B | 0.031 | 0.8 |
| C | 0.098 MIN | 2.5 MIN |
| D | 0.144 | 3.65 |
| E | 0.300 | 7.62 ± 0.25 |
| F | 0.098 ± 0.002 | 0.25 ± 0.05 |
| G | 0.309 ~ 0.346 | 7.85 ~ 8.80 |
| H | 0.047 | 1.2 |
| I | 0.020 | 0.5 |
| J | 0.100 | 2.54 |
| K | 0.252 | 6.4 |

MAXIMUM RATINGS (Ta = 25°C)

| CHARACTERISTIC | SYMBOL | RATING | UNIT |
|---|------------------|------------|------|
| Forward Current | I _F | 20 | mA |
| A Pulse Forward Current (Note) | I _{FP} | 40 | mA |
| Reverse Voltage | V _R | 5 | V |
| Output Current | I _O | 50 | mA |
| Output Voltage | V _O | 7 | V |
| B Supply Voltage (1 Minute Maximum) | V _{CC} | 7 | V |
| Enable Input Voltage (Not to exceed V _{CC} by more than 500mV) | V _{EH} | 5.5 | V |
| Output Collector Power Dissipation | P _O | 85 | mW |
| Operating Temperature Range | T _{opr} | - 0 ~ 70 | °C |
| Storage Temperature Range | T _{stg} | - 55 ~ 125 | °C |

Note: 50% duty cycle, 1ms pulse width.

A - LED B - DETECTOR

PIN CONFIGURATIONS (TOP VIEW)

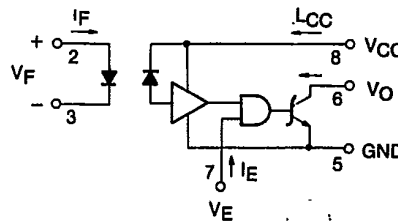
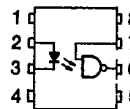

HIGH SPEED COUPLER

T-41-81

OPTO-ELECTRICAL CHARACTERISTICS OVER RECOMMENDED TEMPERATURE ($T_a = 0^\circ\text{C} \sim 70^\circ\text{C}$ Unless otherwise noted)

| CHARACTERISTIC | SYMBOL | TEST CONDITION | MIN. | TYP.* | MAX. | UNIT |
|--|-----------|--|------|-----------|------|----------|
| High Level Output Current | I_{OH} | $V_{CC}=5.5V, V_O=5.5V$ $I_F=250\mu A, V_E=2.0V$ | — | 1 | 250 | μA |
| Low Level Output Voltage | V_{OL} | $V_{CC}=5.5V, I_F=5mA$ $V_{EH}=2.0V, I_{OL}(\text{Sinking})=13mA$ | — | 0.4 | 0.8 | V |
| High Level Enable Current | I_{EH} | $V_{CC}=5.5V, V_E=2.0V$ | — | -1.0 | — | mA |
| Low Level Enable Current | I_{EL} | $V_{CC}=5.5V, V_E=0.5V$ | — | -1.6 | -2.0 | mA |
| High Level Supply Current | I_{CCH} | $V_{CC}=5.5V, I_F=0, V_E=0.5V$ | — | 7 | 15 | mA |
| Low Level Supply Current | I_{CCL} | $V_{CC}=5.5V, I_F=10mA, V_E=0.5V$ | — | 12 | 18 | mA |
| Input-Output Insulation Leakage Current (Note) | I_{I-O} | 45% Relative Humidity $T_a=25^\circ\text{C}, t=5s$ $V_{I-O}=3000Vdc$ | — | — | 1.0 | μA |
| Resistance (Input-Output) (Note) | R_{I-O} | $V_{I-O}=500V, T_a=25^\circ\text{C}$ | — | 10^{12} | — | Ω |
| Capacitance (Input-Output) (Note) | C_{I-O} | $f=1MHz, T_a=25^\circ\text{C}$ | — | 0.6 | — | pF |
| Input Forward Voltage | V_F | $I_F=10mA, T_a=25^\circ\text{C}$ | — | 1.65 | 1.75 | V |
| Input Reverse Breakdown Voltage | BV_R | $I_R=10\mu A, T_a=25^\circ\text{C}$ | 5 | — | — | V |
| Input Capacitance | C_{IN} | $V_F=0, f=1MHz$ | — | 45 | — | pF |
| Current Transfer Ratio | CTR | $I_F=5.0mA, R_L=100\Omega$ | — | 1000 | — | % |

*All typical values are at $V_{CC}=5V, T_a=25^\circ\text{C}$.

Note: Pins 1, 2, 3 and 4 shorted together and Pins 5, 6, 7 and 8 shorted together.

SWITCHING CHARACTERISTICS ($T_a = 25^\circ\text{C}, V_{CC} = 5V$)

| CHARACTERISTIC | SYMBOL | TEST CIRCUIT | TEST CONDITION | MIN. | TYP. | MAX. | UNIT |
|--|-----------------|--------------|--|------|------|------|------------|
| Propagation Delay Time to High Output Level | t_{pLH} | 1 | $R_L=350\Omega, C_L=15pF$ $I_F=7.5mA$ | — | 60 | 75 | ns |
| Propagation Delay Time to Low Output Level | t_{pHL} | | | — | 60 | 75 | ns |
| Output Rise-Fall Time (10-90%) | t_r, t_f | — | — | 30 | — | ns | |
| Propagation Delay Time of Enable from V_{EH} to V_{EL} | t_{ELH} | 2 | $R_L=350\Omega, C_L=15pF$ $I_F=7.5mA, V_{EH}=3.0V$ $V_{EL}=0.5V$ | — | 25 | — | ns |
| Propagation Delay Time of Enable from V_{EL} to V_{EH} | t_{EHL} | | | — | 25 | — | ns |
| Common Mode Transient Immunity at Logic High Output Level | CMH | 3 | $V_{CM}=10V, R_L=350\Omega$ $V_O(\text{min.})=2V,$ $I_F=0mA$ | — | 200 | — | V/ μs |
| Common Mode Transient Immunity at Logic Low Output Level | CM _L | | $V_{CM}=10V, R_L=350\Omega$ $V_O(\text{max.})=0.8V,$ $I_F=5mA$ | — | -500 | — | V/ μs |

HIGH SPEED COUPLER T-41-81

RECOMMENDED OPERATING CONDITIONS

| CHARACTERISTIC | SYMBOL | MIN. | MAX. | UNIT |
|--|-----------|------|----------|-------------|
| Input Current, Low Level Each Channel | I_{FL} | 0 | 250 | μA |
| Input Current, High Level Each Channel | I_{FH} | 7 | 20 | mA |
| High Level Enable Voltage | V_{EH} | 2.0 | V_{CC} | V |
| Low Level Enable Voltage (Output High) | V_{EL} | 0 | 0.8 | V |
| Supply Voltage, Output | V_{CC} | 4.5 | 5.5 | V |
| Fan Out (TTL Load) | N | — | 8 | |
| Operating Temperature | T_{opr} | 0 | 70 | $^{\circ}C$ |

TRUTH TABLE

| INPUT | ENABLE | OUTPUT |
|-------|--------|--------|
| H | H | L |
| L | H | H |
| H | L | H |
| L | L | H |

TEST CIRCUIT 1.

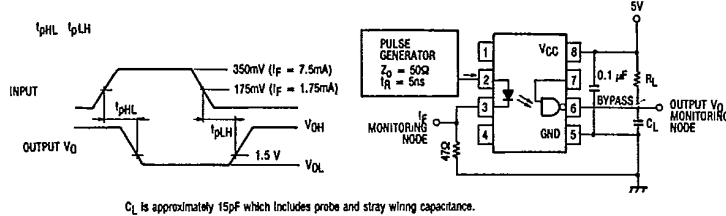

C_L is approximately 15pF which includes probe and stray wiring capacitance.

TEST CIRCUIT 2.

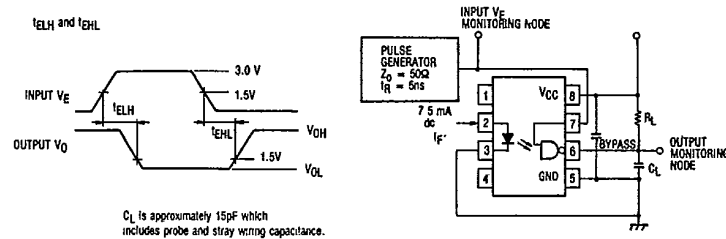

C_L is approximately 15pF which includes probe and stray wiring capacitance.

TEST CIRCUIT 3.

Transient Immunity and Typical Waveforms

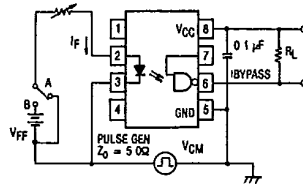
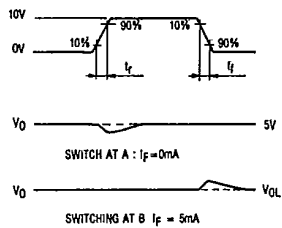

HIGH SPEED COUPLER

T-41-81

