

FEATURES

- Available in Normal & Reverse Polarity
- All Diffused Series
- Industrial Grade
- Available in Avalanche Characteristic

TYPICAL APPLICATIONS

- AVK- SEG alternators

TECHNICAL DATA

DEVICE TYPE	V_{RRM} (V)	V_{RSM} (V)
70NC160/70RC160	1600	1700



SYMBOL	CONDITIONS	VALUES
$I_{F(AV)}$	Maximum average forward Current $T_c = 140^{\circ}C$	70A
V_{FM}	Maximum peak forward Voltage drop @ Rated I_F (Peak)	1.35 V
I_{FSM}	Maximum peak one cycle (non-rep.) surge current 10 msec	1200 A
I^2t	Max. I^2t rating (non-rep.) for 10 msec	7100 A ² Sec
I_{RRM}	Peak reverse current at $T_{vj} = 140^{\circ}C$	10 mA
V_0 R_0	$T_{vj} = \text{max}$ $T_{vj} = \text{max}$	0.85 V 3.0 mΩ
$R_{th(j-c)}$ $R_{th(c-h)}$ T_{vj} T_{stg}	Maximum thermal resistance (Junction to case) Maximum thermal resistance (Case to heat sink) Junction temperature Storage temperature	0.45 °C/W 0.25 °C/W 180 °C 180 °C
Mounting torque		4 Nm
Weight	Approx.	46 gms
Package Outline		C

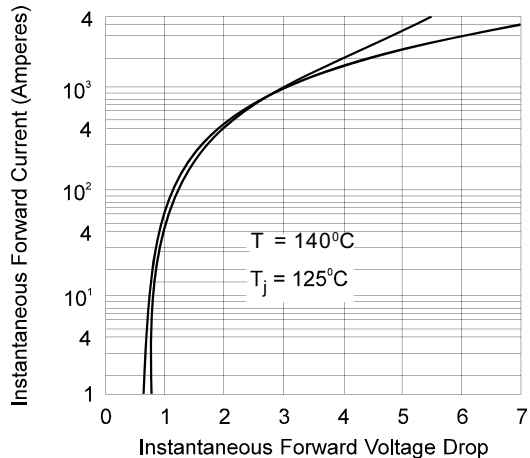

Fig. 1 - Forward Voltage Drop Vs. Forward Current

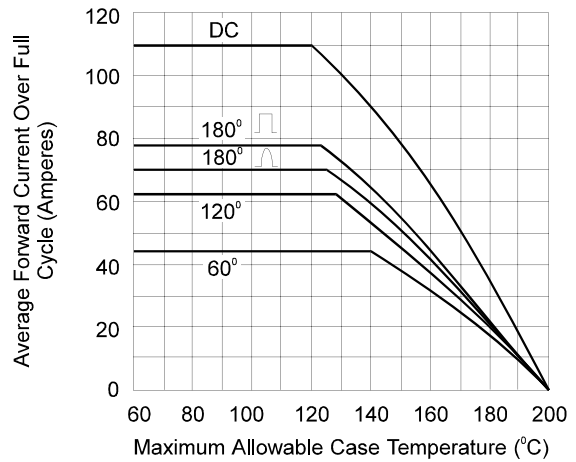

Fig. 2 - Average Forward Current Vs. Case Temperature

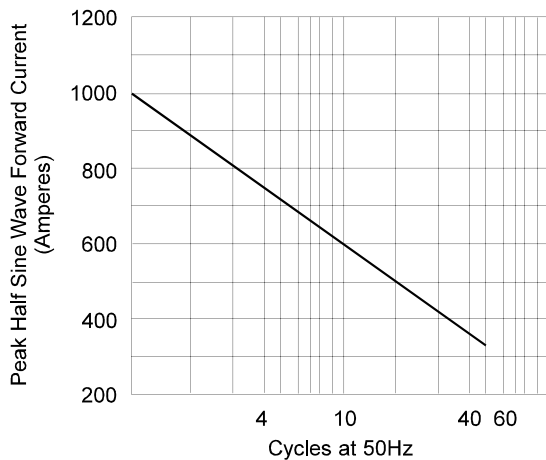

Fig. 3 - Maximum Non Recurrent Surge Current

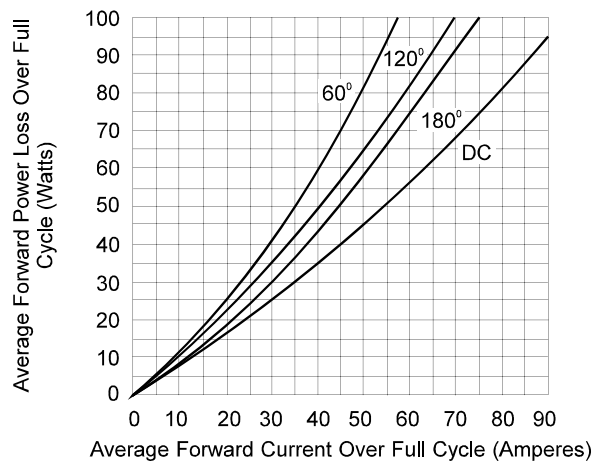

Fig. 4 - Maximum Forward Power Loss Vs. Low Level Forward Current

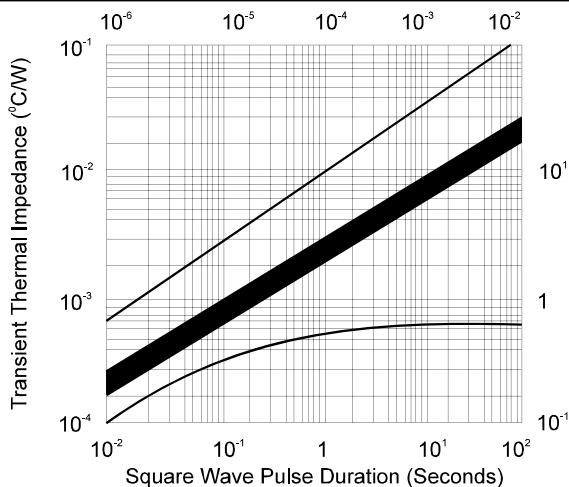

Fig. 5 - Transient Thermal Impedance

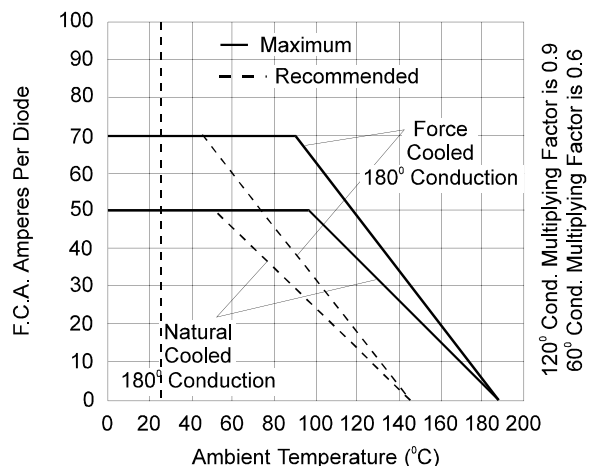
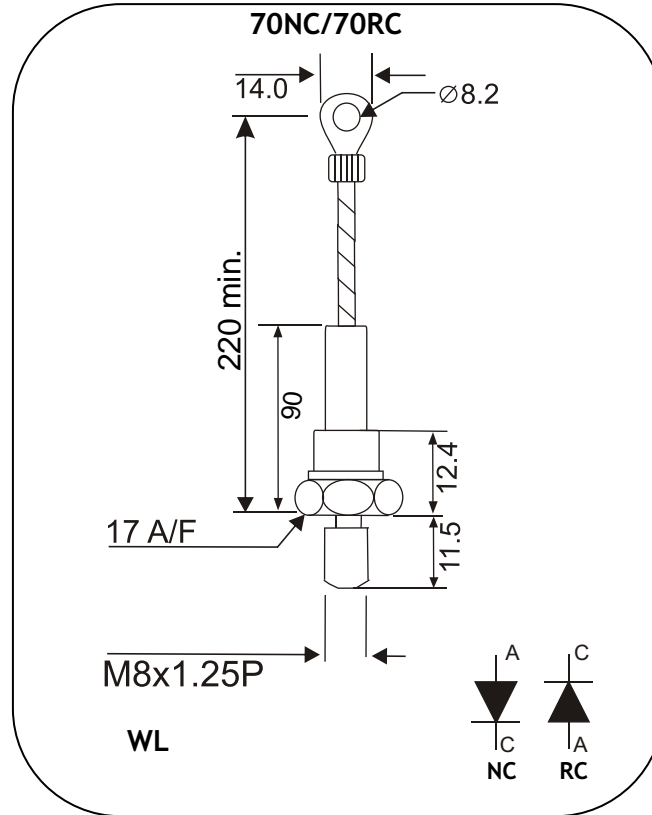

Fig. 6 - Diode Mounted on Heat Sink Type K4 with $\theta_{HA-NC-0.95}^{\circ} C/W$, FC $0.30^{\circ} C/W$

120° Cond. Multiplying Factor is 0.9
60° Cond. Multiplying Factor is 0.6

PACKAGE OUTLINE



All dimensions are in mm.

Insel Rectifiers (India) Pvt. Ltd.

(An ISO 9001:2015, ISO 14001:2015 Certified Company)

Plot No 151, Udyog Kendra, Extn.-II, Ecotech-III, Greater Noida-201306

Toll Free No.: 1800 3070 9989, Fax : 011-27491404

E-mail : insel@rectifierindia.com, sales@rectifierindia.com