

Technical Data Sheet

5 mm Round LED, T-1 3/4

7343/R5C2-AQTB/X/MS

Features

- Popular T-1 3/4 diameter package.
- Choice of various viewing angles.
- Available on tape and reel.
- Reliable and robust.
- The product itself will remain within RoHS compliant version.
- UV resistant epoxy



Descriptions

- The series is specially designed for applications requiring higher brightness.
- The LED lamps are available with different colors,intensities,epoxy colors, etc.
- Superior performance in outdoor environment

Applications

- Color Graphic Signs
- Message boards
- Variable message signs (VMS)
- Commercial outdoor advertising

Device Selection Guide

LED Part No.	Chip		Lens Color	Stopper
	Material	Emitted Color		
7343/R5C2-AQTB /MS	AlGaInP	Brilliant Red	Water Clear	No
7343/R5C2-AQTB/P/MS				Yes

Technical Data Sheet
5 mm Round LED, T-1 3/4

7343/R5C2-AQTB/X/MS

Package Dimensions

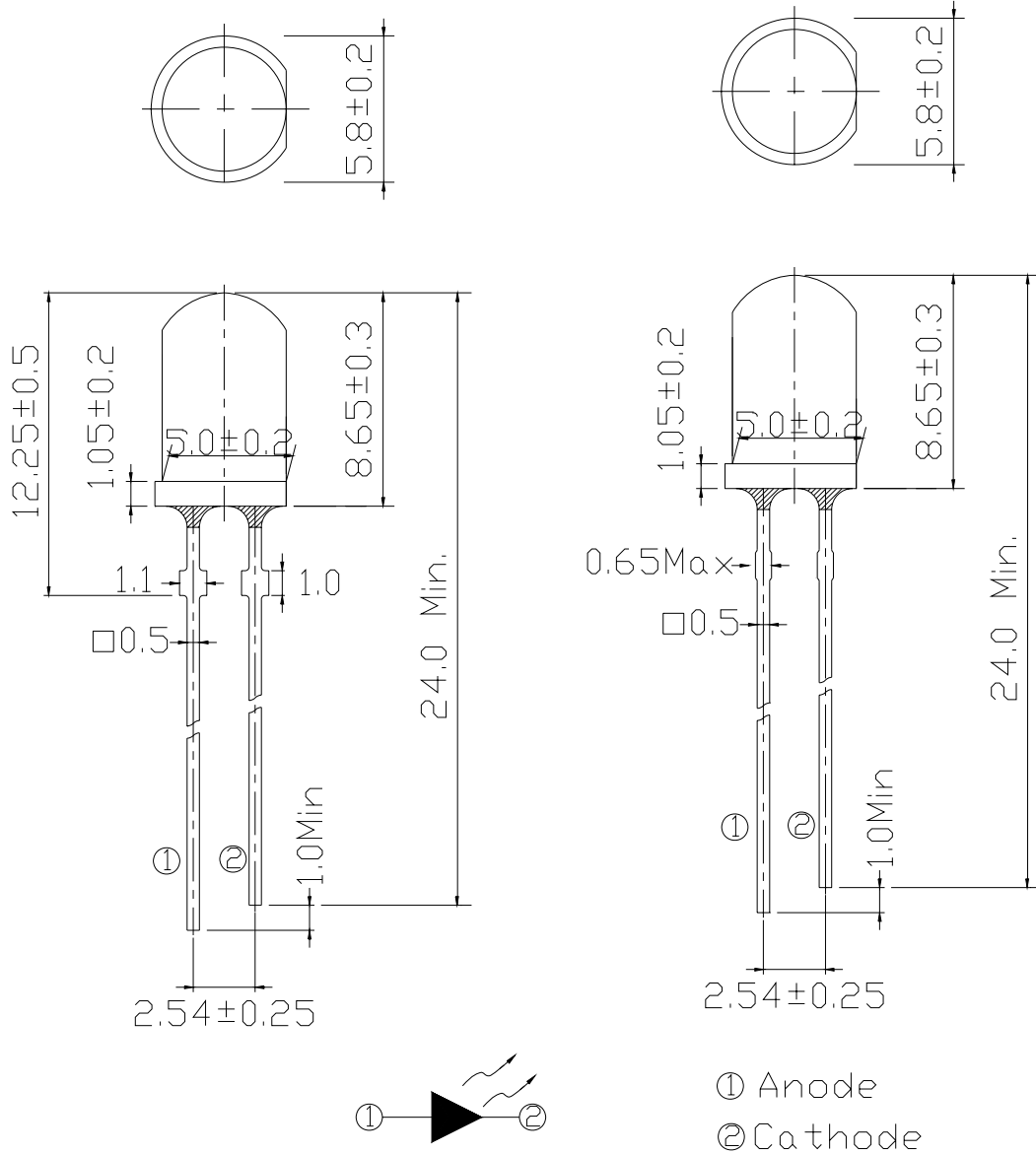

Notes:

- All dimensions are in millimeters, tolerance is 0.25mm except being specified.
- Lead spacing is measured where the lead emerges from the package.
- Protruded resin under flange is 1.5mm Max LED.



Technical Data Sheet

5 mm Round LED, T-1 3/4

7343/R5C2-AQTB/X/MS

Absolute Maximum Ratings (Ta=25°C)

Parameter	Symbol	Rating	Units
Forward Current	I _F	50	mA
Pulse Forward Current ^{*1}	I _{FP}	160	mA
Operating Temperature	T _{opr}	-40 ~ +85	°C
Storage Temperature	T _{stg}	-40 ~ +100	°C
Electrostatic Discharge	ESD	2K	V
Soldering Temperature ^{*2}	T _{sol}	260 ±5	°C
Power Dissipation	P _d	115	mW
Reverse Voltage	V _R	5	V

Notes: *1:I_{FP} Conditions--Pulse Width ≤ 10msec and Duty ≤ 1/10.

*2:Soldering time ≤ 5 seconds.

Electro-Optical Characteristics (Ta=25°C)

Parameter	Symbol	Condition	Min.	Typ.	Max.	Units
Forward Voltage	V _F	I _F =20mA	1.8	2.0	2.6	V
Luminous Intensity	I _v	I _F =20mA	3600	5650	9000	mcd
Viewing Angle	2θ 1/2	I _F =20mA	--	25	--	deg
Peak Wavelength	λ _p	I _F =20mA	--	632	--	nm
Dominant Wavelength	λ _d	I _F =20mA	620	624	628	nm
Spectrum Radiation Bandwidth	Δλ	I _F =20mA	--	20	--	nm
Reverse Current	I _R	V _R =5V	--	--	10	μA

**Technical Data Sheet**
5 mm Round LED, T-1 3/4**7343/R5C2-AQTB/X/MS****Rank Combination ($I_F=20\text{mA}$)**

Rank	Q	R	S	T
Luminous Intensity	3600~4500	4500~5650	5650~7150	7150~9000

*Measurement Uncertainty of Luminous Intensity: $\pm 15\%$

Unit: :mcd

Rank	1	2	3	4
Forward Voltage	1.8~2.0	2.0~2.2	2.2~2.4	2.4~2.6

*Measurement Uncertainty of Forward Voltage: $\pm 0.1\text{V}$

Unit:V

Rank	1	2
Dominant Wavelength	620~624	624~628

*Measurement Uncertainty of Dominant Wavelength $\pm 1.0\text{nm}$

Unit:nm

*The quantity ratio of the ranks is decided by EVERLIGHT.

Technical Data Sheet
5 mm Round LED, T-1 3/4

7343/R5C2-AQTB/X/MS

Typical Electro-Optical Characteristics Curves

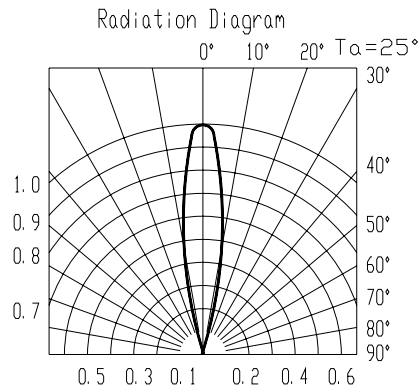
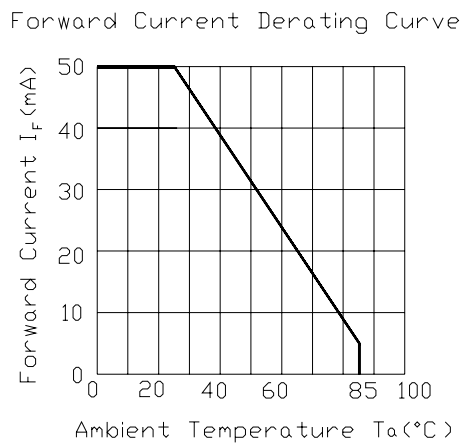
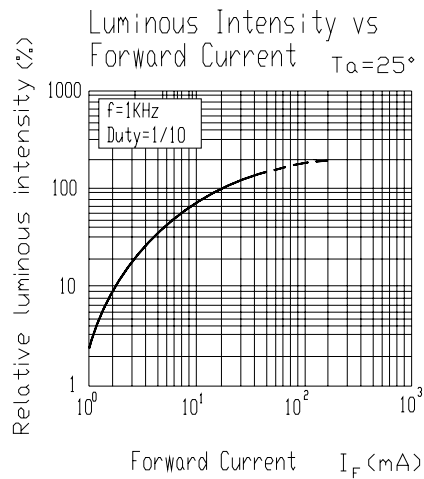
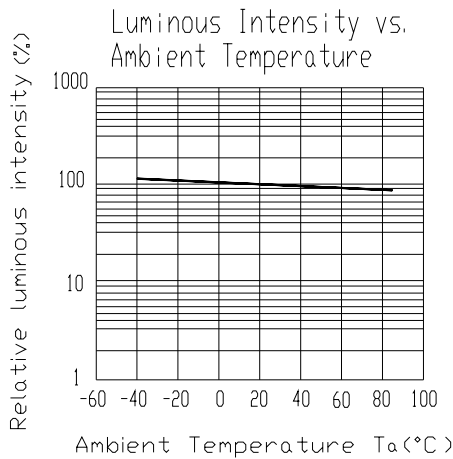
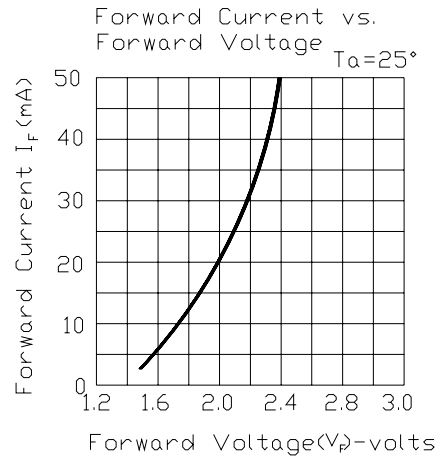
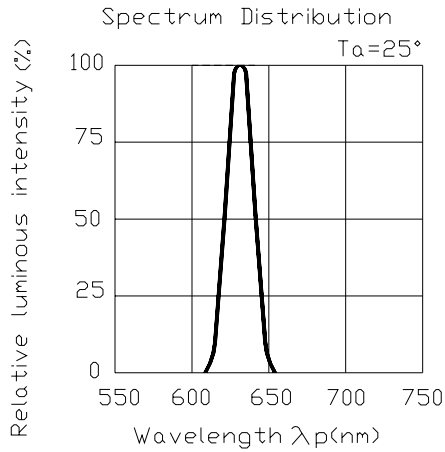



Technical Data Sheet
5 mm Round LED, T-1 3/4

7343/R5C2-AQTB/X/MS

Label Form Specification

EVERLIGHT	
CPN:	
P/N:	
	
7343/R5C2-AQTB/X/MS	
QTY :	CAT:
	HUE:
LOT NO :	REF:
	
MADE IN TAIWAN	

CPN: Customer's Production Number
P/N : Production Number
QTY: Packing Quantity
CAT: Ranks of Luminous Intensity and Forward Voltage
HUE: Ranks of Dominant Wavelength
REF: Reference
LOT No: Lot Number
MADE IN TAIWAN: Production Place



Technical Data Sheet
5 mm Round LED, T-1 3/4

7343/R5C2-AQTB/X/MS

Notes

1. Above specification may be changed without notice. EVERLIGHT will reserve authority on material change for above specification.
2. When using this product, please observe the absolute maximum ratings and the instructions for using outlined in these specification sheets. EVERLIGHT assumes no responsibility for any damage resulting from use of the product which does not comply with the absolute maximum ratings and the instructions included in these specification sheets.
3. These specification sheets include materials protected under copyright of EVERLIGHT corporation. Please don't reproduce or cause anyone to reproduce them without EVERLIGHT's consent.
4. Soldering Condition

Careful attention should be paid during soldering. When soldering, leave more than 3mm from solder joint to case, and soldering beyond the base of the tie bar is recommended.

Avoiding applying any stress to the lead frame while the LEDs are at high temperature particularly when soldering.

Recommended soldering conditions:

Hand Soldering		DIP Soldering	
Temp. at tip of iron	400°C Max. (30W Max.)	Preheat temp.	100°C Max. (60 sec Max.)
Soldering time	3 sec Max.	Bath temp.	265 Max.
Distance	3mm Min.(From solder joint to case)	Bath time.	5 sec Max.
		Distance	3mm Min.

EVERLIGHT ELECTRONICS CO., LTD.
 Office: No 25, Lane 76, Sec 3, Chung Yang Rd,
 Tucheng, Taipei 236, Taiwan, R.O.C

Tel: 886-2-2267-2000, 2267-9936
 Fax: 886-2267-6244, 2267-6189, 2267-6306
<http://www.everlight.com>