

# DATA SHEET

For a complete data sheet, please also download:

- The IC06 74HC/HCT/HCU/HCMOS Logic Family Specifications
- The IC06 74HC/HCT/HCU/HCMOS Logic Package Information
- The IC06 74HC/HCT/HCU/HCMOS Logic Package Outlines

## **74HC/HCT7245** Octal bus Schmitt-trigger transceiver; 3-state

Product specification  
File under Integrated Circuits, IC06

December 1990

# Octal bus Schmitt-trigger transceiver; 3-state

## 74HC/HCT7245

### FEATURES

- Octal bidirectional bus interface
- Non-inverting 3-state outputs
- Output capability: bus driver
- I<sub>CC</sub> category: MSI
- Schmitt-trigger action on all data inputs

### GENERAL DESCRIPTION

The 74HC/HCT7245 are high-speed Si-gate CMOS devices and are pin compatible with low power Schottky TTL (LSTTL). They are specified in

compliance with JEDEC standard no. 7A.

The 74HC/HCT7245 are octal transceivers featuring non-inverting 3-state bus compatible outputs in both send and receive directions. The "7245" features an output enable ( $\overline{OE}$ ) input for easy cascading and a send/receive input (DIR) for direction control.  $\overline{OE}$  controls the outputs so that the buses are effectively isolated. The 74HC/HCT7245 have Schmitt-trigger inputs. These inputs are capable of transforming slowly changing input signals into sharply defined jitter-free output signals.

The "7245" is identical to the "245" but has hysteresis on the data inputs.

### FUNCTION TABLE

INPUTS		INPUTS/OUTPUTS	
$\overline{OE}$	DIR	A <sub>n</sub>	B <sub>n</sub>
L	L	A = B	inputs
L	H	inputs	B = A
H	X	Z	Z

### Notes

1. H = HIGH voltage level  
L = LOW voltage level  
X = don't care  
Z = high impedance OFF-state

### QUICK REFERENCE DATA

GND = 0 V; T<sub>amb</sub> = 25 °C; t<sub>r</sub> = t<sub>f</sub> = 6 ns

SYMBOL	PARAMETER	CONDITIONS	TYPICAL		UNIT
			HC	HCT	
t <sub>PHL</sub> / t <sub>PLH</sub>	propagation delay A <sub>n</sub> to B <sub>n</sub>	C <sub>L</sub> = 15 pF; V <sub>CC</sub> = 5 V	8	12	ns
C <sub>I</sub>	input capacitance		3.5	3.5	pF
C <sub>I/O</sub>	input/output capacitance		10	10	pF
C <sub>PD</sub>	power dissipation capacitance per transceiver	notes 1 and 2	40	40	pF

### Notes

1. C<sub>PD</sub> is used to determine the dynamic power dissipation (P<sub>D</sub> in μW):

$$P_D = C_{PD} \times V_{CC}^2 \times f_i + \sum (C_L \times V_{CC}^2 \times f_o) \text{ where:}$$

f<sub>i</sub> = input frequency in MHz

f<sub>o</sub> = output frequency in MHz

∑ (C<sub>L</sub> × V<sub>CC</sub><sup>2</sup> × f<sub>o</sub>) = sum of outputs

C<sub>L</sub> = output load capacitance in pF

V<sub>CC</sub> = supply voltage in V

2. For HC the condition is V<sub>1</sub> = GND to V<sub>CC</sub>  
For HCT the condition is V<sub>1</sub> = GND to V<sub>CC</sub> - 1.5 V

### ORDERING INFORMATION

See "74HC/HCT/HCU/HCMOS Logic Package Information".

# Octal bus Schmitt-trigger transceiver; 3-state

74HC/HCT7245

## PIN DESCRIPTION

PIN NO.	SYMBOL	NAME AND FUNCTION
1	DIR	direction control
2, 3, 4, 5, 6, 7, 8, 9	A <sub>0</sub> to A <sub>7</sub>	data inputs/outputs
10	GND	ground (0 V)
18, 17, 16, 15, 14, 13, 12, 11	B <sub>0</sub> to B <sub>7</sub>	data inputs/outputs
19	$\overline{OE}$	output enable input (active LOW)
20	V <sub>CC</sub>	positive supply voltage

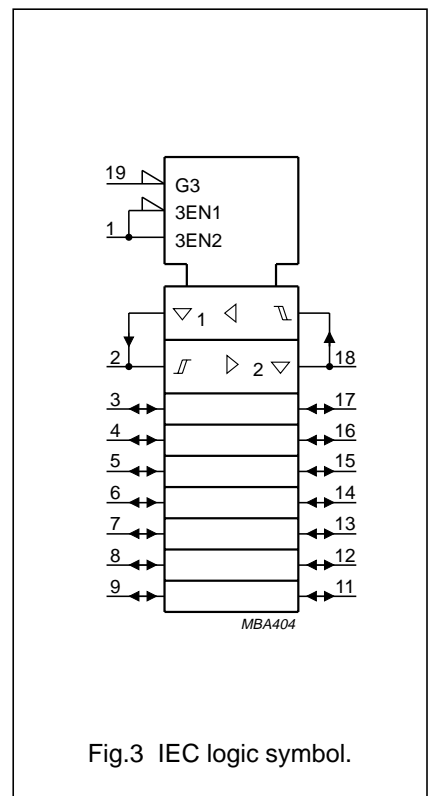
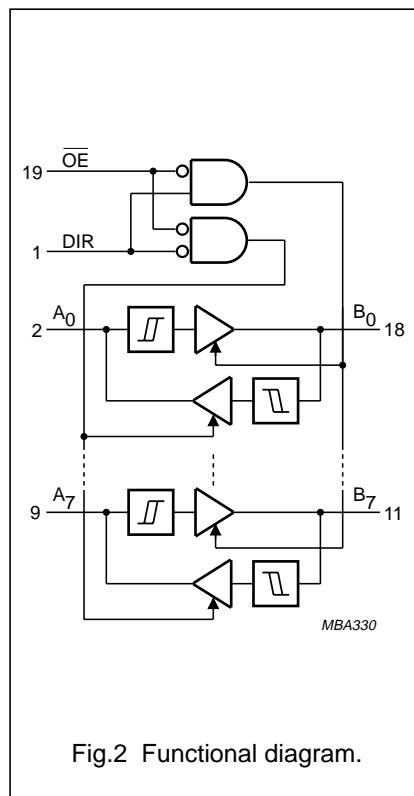
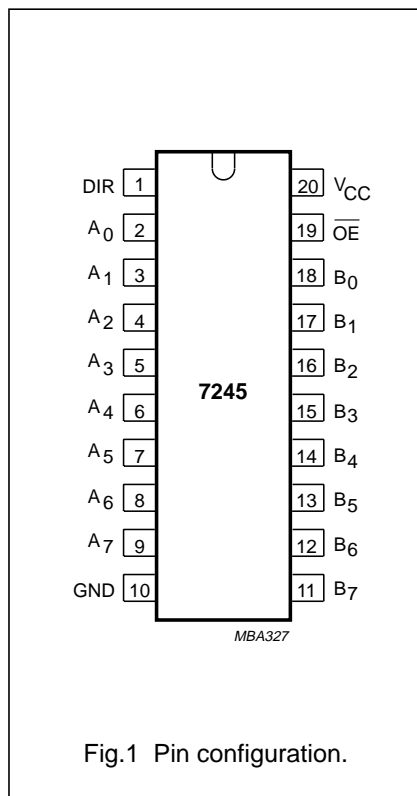

# Octal bus Schmitt-trigger transceiver; 3-state

74HC/HCT7245

## DC CHARACTERISTICS FOR 74HC

For the DC characteristics see *"74HC/HCT/HCU/HCMOS Logic Family Specifications"*.

Output capability: bus driver

I<sub>CC</sub> category: MSI

## TRANSFER CHARACTERISTICS FOR 74HC

Voltages are referred to GND (ground = 0 V)

SYMBOL	PARAMETER	T <sub>amb</sub> (°C)						UNIT	TEST CONDITIONS		
		74HC							V <sub>CC</sub> (V)	WAVEFORMS	
		+25			-40 to +85		-40 to +125				
		min.	typ.	max.	min.	max.	min.				max.
V <sub>T+</sub>	positive-going threshold			1.50 3.15 4.20		1.50 3.15 4.20		1.50 3.15 4.20	V	2.0 4.5 6.0	Figs. 4 and 5
V <sub>T-</sub>	negative-going threshold	0.30 1.35 1.80			0.30 1.35 1.80		0.30 1.35 1.80		V	2.0 4.5 6.0	Figs. 4 and 5
V <sub>H</sub>	hysteresis (V <sub>T+</sub> - V <sub>T-</sub> )	0.1 0.25 0.3	0.2 0.4 0.5		0.1 0.25 0.3		0.1 0.25 0.3		V	2.0 4.5 6.0	Figs. 4 and 5

## AC CHARACTERISTICS FOR 74HC

GND = 0 V; t<sub>r</sub> = t<sub>f</sub> = 6 ns; C<sub>L</sub> = 50 pF

SYMBOL	PARAMETER	T <sub>amb</sub> (°C)						UNIT	TEST CONDITIONS		
		74HC							V <sub>CC</sub> (V)	WAVEFORMS	
		+25			-40 to +85		-40 to +125				
		min.	typ.	max.	min.	max.	min.				max.
t <sub>PHL</sub> / t <sub>PLH</sub>	propagation delay A <sub>n</sub> to B <sub>n</sub> ; B <sub>n</sub> to A <sub>n</sub>		33 12 10	100 20 17		125 25 21		150 30 26	ns	2.0 4.5 6.0	Fig.7
t <sub>PZH</sub> / t <sub>PZL</sub>	3-state output enable time $\overline{OE}$ to A <sub>n</sub> ; $\overline{OE}$ to B <sub>n</sub>		47 17 14	160 32 27		200 40 34		240 48 41	ns	2.0 4.5 6.0	Fig.7
t <sub>PHZ</sub> / t <sub>PLZ</sub>	3-state output disable time $\overline{OE}$ to A <sub>n</sub> ; $\overline{OE}$ to B <sub>n</sub>		52 19 16	160 32 27		200 40 34		240 48 41	ns	2.0 4.5 6.0	Fig.7
t <sub>THL</sub> / t <sub>TLH</sub>	output transition time		14 5 4	60 12 10		75 15 13		90 18 15	ns	2.0 4.5 6.0	Fig.7

# Octal bus Schmitt-trigger transceiver; 3-state

74HC/HCT7245

## DC CHARACTERISTICS FOR 74HCT

For the DC characteristics see *"74HC/HCT/HCU/HCMOS Logic Family Specifications"*.

Output capability: bus driver

I<sub>CC</sub> category: MSI

### Note to HCT types

The value of additional quiescent supply current ( $\Delta I_{CC}$ ) for a unit load of 1 is given in the family specifications. To determine  $\Delta I_{CC}$  per input, multiply this value by the unit load coefficient shown in the table below.

INPUT	UNIT LOAD COEFFICIENT
A <sub>n</sub>	0.33
B <sub>n</sub>	0.33
$\overline{OE}$	1.50
DIR	1.00

## TRANSFER CHARACTERISTICS FOR 74HCT

Voltages are referred to GND (ground = 0 V)

SYMBOL	PARAMETER	T <sub>amb</sub> (°C)							UNIT	TEST CONDITIONS	
		74HCT								V <sub>CC</sub> (V)	WAVEFORMS
		+25			-40 to +85		-40 to +125				
		min.	typ.	max.	min.	max.	min.	max.			
V <sub>T+</sub>	positive-going threshold			2.0 2.1		2.0 2.1		2.0 2.1	V	4.5 5.5	Figs. 4 and 5
V <sub>T-</sub>	negative-going threshold	0.7 0.8			0.64 0.74		0.6 0.7		V	4.5 5.5	Figs. 4 and 5
V <sub>H</sub>	hysteresis (V <sub>T+</sub> - V <sub>T-</sub> )	0.17 0.17	0.23 0.23						V	4.5 5.5	Figs. 4 and 5

# Octal bus Schmitt-trigger transceiver; 3-state

74HC/HCT7245

## AC CHARACTERISTICS FOR 74HCT

GND = 0 V;  $t_r = t_f = 6$  ns;  $C_L = 50$  pF

SYMBOL	PARAMETER	T <sub>amb</sub> (°C)						UNIT	TEST CONDITIONS		
		74HCT							V <sub>CC</sub> (V)	WAVEFORMS	
		+25			-40 to +85		-40 to +125				
		min.	typ.	max.	min.	max.	min.				max.
t <sub>PHL</sub> / t <sub>PLH</sub>	propagation delay A <sub>n</sub> to B <sub>n</sub> ; B <sub>n</sub> to A <sub>n</sub>		17	30		37		45	ns	4.5	Fig.7
t <sub>PZH</sub> / t <sub>PZL</sub>	3-state output enable time $\overline{OE}$ to A <sub>n</sub> ; $\overline{OE}$ to B <sub>n</sub>		19	32		40		48	ns	4.5	Fig.7
t <sub>PHZ</sub> / t <sub>PLZ</sub>	3-state output disable time $\overline{OE}$ to A <sub>n</sub> ; $\overline{OE}$ to B <sub>n</sub>		19	32		40		48	ns	4.5	Fig.7
t <sub>THL</sub> / t <sub>TLH</sub>	output transition time		5	12		15		18	ns	4.5	Fig.7

## TRANSFER CHARACTERISTIC WAVEFORMS

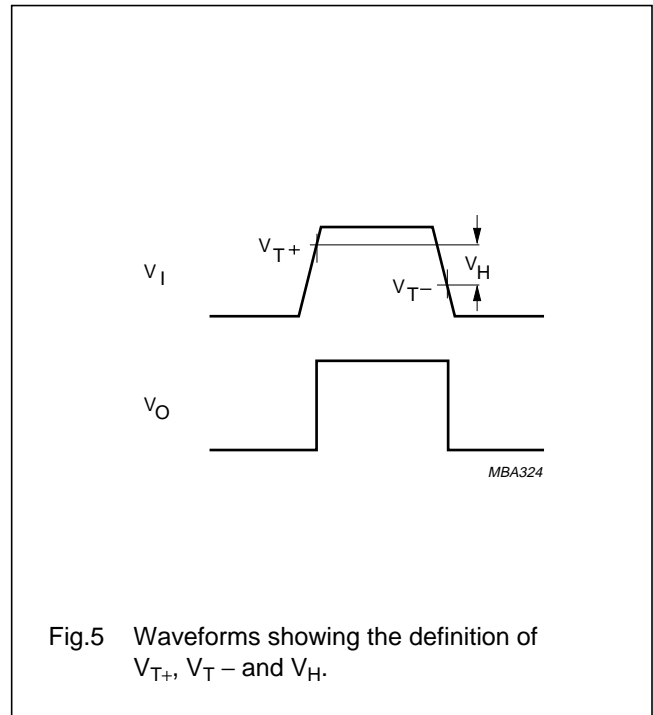
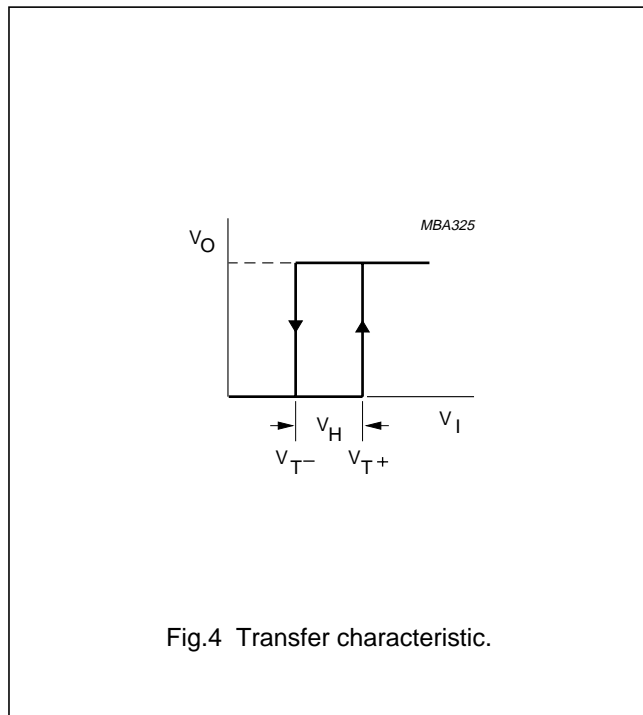

# Octal bus Schmitt-trigger transceiver; 3-state

74HC/HCT7245

## AC WAVEFORMS

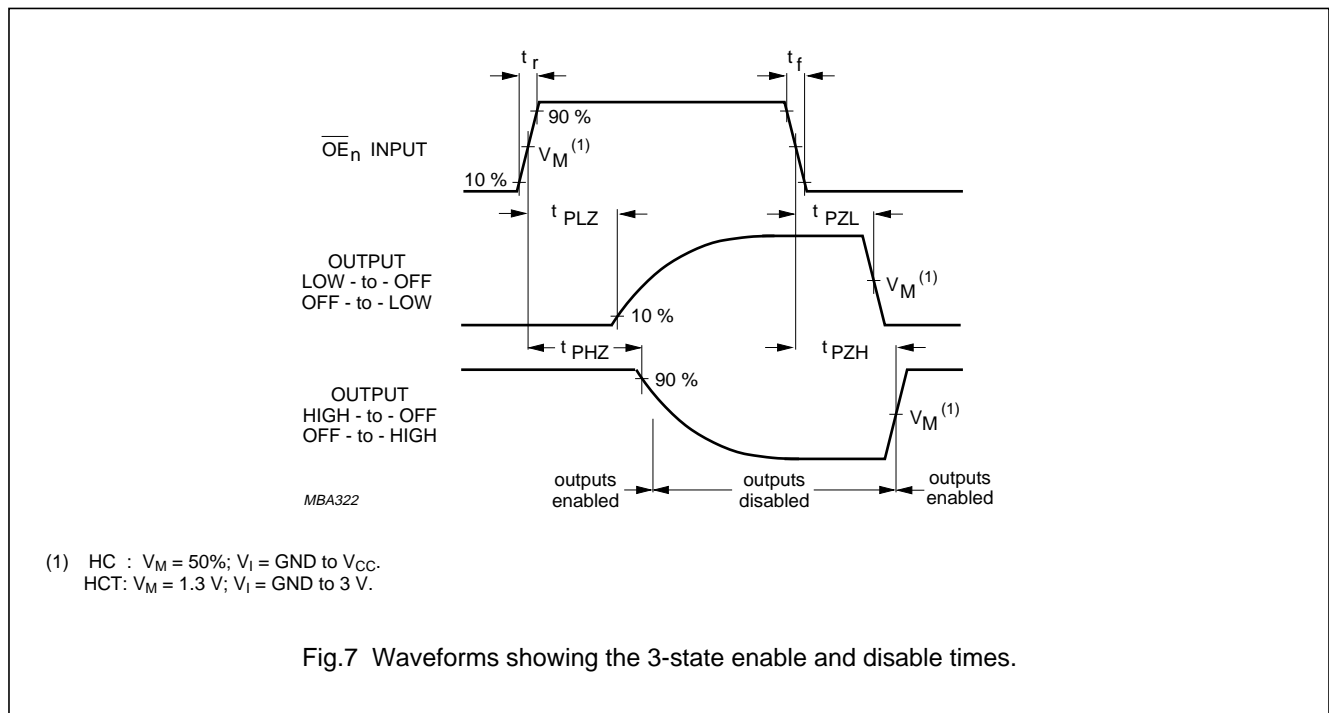
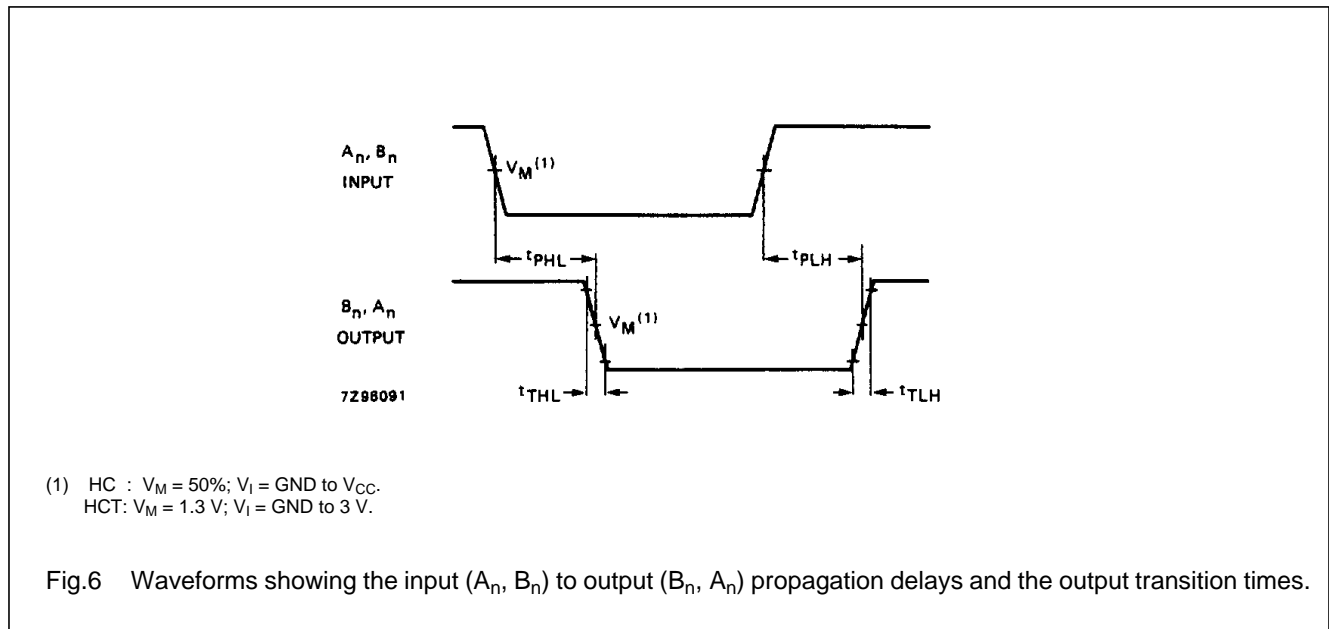

## PACKAGE OUTLINES

See "74HC/HCT/HCU/HCMOS Logic Package Outlines".