

74VCX162838

Low Voltage 16-Bit Selectable Register/Buffer with 3.6V Tolerant Inputs and Outputs and 26Ω Series Resistors in the Outputs

General Description

The VCX162838 contains sixteen non-inverting selectable buffered or registered paths. The device can be configured to operate in a registered, or flow through buffer mode by utilizing the register enable (REGE) and Clock (CP) signals. The device operates in a 16-bit word wide mode. All outputs can be placed into 3-State through the use of the \overline{OE} pin. These devices are ideally suited for buffered or registered 168 pin and 200 pin SDRAM DIMM memory modules.

The 74VCX162838 is designed for low voltage (1.65V to 3.6V) V_{CC} applications with I/O compatibility up to 3.6V. The VCX162838 is also designed with 26Ω series resistors in the outputs. This design reduces line noise in applications such as memory address drivers, clock drivers, and bus transceivers/transmitters.

The 74VCX162838 is fabricated with an advanced CMOS technology to achieve high speed operation while maintaining low CMOS power dissipation.

Features

- Compatible with PC100 and PC133 DIMM module specifications
- 1.65V–3.6V V_{CC} supply operation
- 3.6V tolerant inputs and outputs
- 26Ω series resistors in the outputs
- t_{PD} (CP to O_n)
 - 3.9 ns max for 3.0V to 3.6V V_{CC}
 - 5.4 ns max for 2.3V to 2.7V V_{CC}
 - 9.8 ns max for 1.65V to 1.95V V_{CC}
- Power-off high impedance inputs and outputs
- Supports live insertion and withdrawal (Note 1)
- Static Drive (I_{OH}/I_{OL})
 - ±12 mA @ 3.0V V_{CC}
 - ±8 mA @ 2.3V V_{CC}
 - ±3 mA @ 1.65V V_{CC}
- Uses patented noise/EMI reduction circuitry
- Latch-up performance exceeds 300 mA
- ESD performance:
 - Human body model > 2000V
 - Machine model > 200V

Note 1: To ensure the high-impedance state during power up or power down, \overline{OE} should be tied to V_{CC} through a pull-up resistor. The minimum value of the resistor is determined by the current -sourcing capability of the driver.

Ordering Code:

Ordering Code	Package Number	Package Descriptions
74VCX162838MTD	MTD48	48-Lead Thin Shrink Small Outline Package (TSSOP), JEDEC MO-153, 6.1mm Wide

Devices also available in Tape and Reel. Specify by appending suffix letter "X" to the ordering code.

Logic Symbol

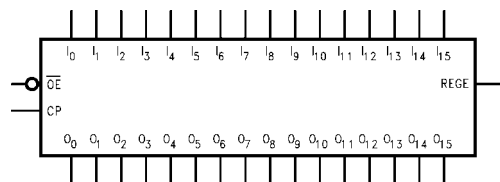

Pin Descriptions

Pin Names	Description
\overline{OE}	Output Enable Input (Active LOW)
I_0 – I_{15}	Inputs
O_0 – O_{15}	Outputs
CP	Clock Pulse Input
REGE	Register Enable Input

74VCX162838 Low Voltage 16-Bit Selectable Register/Buffer with 3.6V Tolerant Inputs and Outputs and 26Ω Series Resistors in the Outputs

Connection Diagram

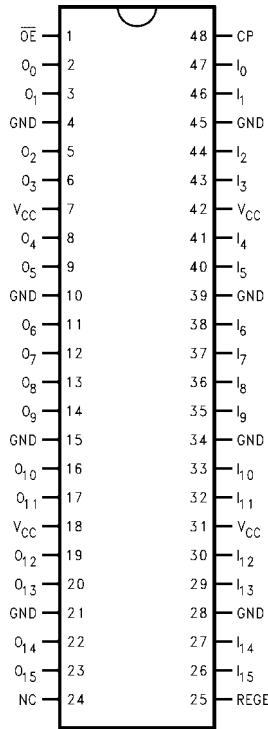

Truth Table

Inputs				Outputs
CP	REGE	I _n	\overline{OE}	O _n
↑	H	H	L	H
↑	H	L	L	L
X	L	H	L	H
X	L	L	L	L
X	X	X	H	Z

H = HIGH Voltage Level
 L = LOW Voltage Level
 X = Immaterial (HIGH or LOW, inputs may not float)
 Z = High Impedance

Functional Description

The 74VCX162838 consists of sixteen selectable non-inverting buffers or registers with word wide controls. Mode functionality is selected through operation of the CP and REGE pin as shown by the truth table. When REGE is held at a logic "1" the device operates as a 16-bit register. Data is transferred from I_n to O_n on the rising edge of the CP pin. When the REGE pin is held at a logic "0" the device operates in a flow through mode and data propagates directly from the I to the O outputs. All outputs can be 3-stated by holding the \overline{OE} pin at a logic "1".

Logic Diagram

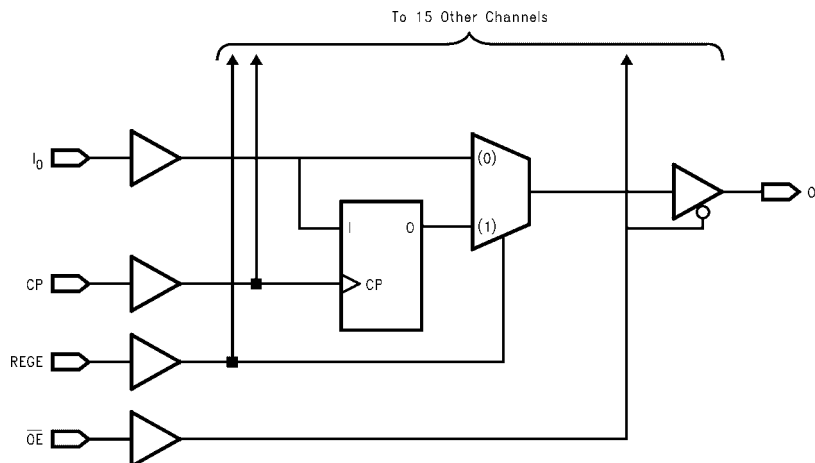

Absolute Maximum Ratings (Note 2)		Recommended Operating Conditions (Note 4)	
Supply Voltage (V_{CC})	-0.5V to +4.6V	Power Supply	
DC Input Voltage (V_I)	-0.5V to +4.6V	Operating	1.65V to 3.6V
Output Voltage (V_O)		Data Retention Only	1.2V to 3.6V
Outputs 3-STATE	-0.5V to +4.6V	Input Voltage	-0.3V to +3.6V
Outputs Active (Note 3)	-0.5V to $V_{CC} + 0.5V$	Output Voltage (V_O)	
DC Input Diode Current (I_{IK}) $V_I < 0V$	-50 mA	Output in Active States	0V to V_{CC}
DC Output Diode Current (I_{OK})		Output in "OFF" State	0.0V to 3.6V
$V_O < 0V$	-50 mA	Output Current in I_{OH}/I_{OL}	
$V_O > V_{CC}$	+50 mA	$V_{CC} = 3.0V$ to 3.6V	± 12 mA
DC Output Source/Sink Current		$V_{CC} = 2.3V$ to 2.7V	± 8 mA
(I_{OH}/I_{OL})	± 50 mA	$V_{CC} = 1.65V$ to 2.3V	± 3 mA
DC V_{CC} or GND Current per		Free Air Operating Temperature (T_A)	-40°C to +85°C
Supply Pin (I_{CC} or GND)	± 100 mA	Minimum Input Edge Rate ($\Delta t/\Delta V$)	
Storage Temperature Range (T_{STG})	-65°C to +150°C	$V_{IN} = 0.8V$ to 2.0V, $V_{CC} = 3.0V$	10 ns/V

Note 2: The Absolute Maximum Ratings are those values beyond which the safety of the device cannot be guaranteed. The device should not be operated at these limits. The parametric values defined in the Electrical Characteristics tables are not guaranteed at the Absolute Maximum Ratings. The "Recommended Operating Conditions" table will define the conditions for actual device operation.

Note 3: I_O Absolute Maximum Rating must be observed.

Note 4: Floating or unused inputs must be held HIGH or LOW.

DC Electrical Characteristics (2.7V < V_{CC} ≤ 3.6V)

Symbol	Parameter	Conditions	V_{CC} (V)	Min	Max	Units
V_{IH}	HIGH Level Input Voltage		2.7-3.6	2.0		V
V_{IL}	LOW Level Input Voltage		2.7-3.6		0.8	V
V_{OH}	HIGH Level Output Voltage	$I_{OH} = -100 \mu A$	2.7-3.6	$V_{CC} - 0.2$		V
		$I_{OH} = -6$ mA	2.7	2.2		V
		$I_{OH} = -8$ mA	3.0	2.4		V
		$I_{OH} = -12$ mA	3.0	2.2		V
V_{OL}	LOW Level Output Voltage	$I_{OL} = 100 \mu A$	2.7-3.6		0.2	V
		$I_{OL} = 6$ mA	2.7		0.4	V
		$I_{OL} = 8$ mA	3.0		0.55	V
		$I_{OL} = 12$ mA	3.0		0.8	V
I_I	Input Leakage Current	$0 \leq V_I \leq 3.6V$	2.7-3.6		± 5.0	μA
I_{OZ}	3-STATE Output Leakage	$0 \leq V_O \leq 3.6V$ $V_I = V_{IH}$ or V_{IL}	2.7-3.6		± 10	μA
I_{OFF}	Power-OFF Leakage Current	$0 \leq (V_I, V_O) \leq 3.6V$	0		10	μA
I_{CC}	Quiescent Supply Current	$V_I = V_{CC}$ or GND	2.7-3.6		20	μA
		$V_{CC} \leq (V_I, V_O) \leq 3.6V$ (Note 5)	2.7-3.6		± 20	μA
ΔI_{CC}	Increase in I_{CC} per Input	$V_{IH} = V_{CC} - 0.6V$	2.7-3.6		750	μA

Note 5: Outputs disabled or 3-STATE only.

DC Electrical Characteristics ($2.3V \leq V_{CC} \leq 2.7V$)						
Symbol	Parameter	Conditions	V _{CC} (V)	Min	Max	Units
V _{IH}	HIGH Level Input Voltage		2.3–2.7	1.6		V
V _{IL}	LOW Level Input Voltage		2.3–2.7		0.7	V
V _{OH}	HIGH Level Output Voltage	I _{OH} = –100 μA	2.3–2.7	V _{CC} – 0.2		V
		I _{OH} = –4 mA	2.3	2.0		V
		I _{OH} = –6 mA	2.3	1.8		V
		I _{OH} = –8 mA	2.3	1.7		V
V _{OL}	LOW Level Output Voltage	I _{OL} = 100 μA	2.3–2.7		0.2	V
		I _{OL} = 6 mA	2.3		0.4	V
		I _{OL} = 8 mA	2.3		0.6	V
I _I	Input Leakage Current	0 ≤ V _I ≤ 3.6V	2.3–2.7		±5.0	μA
I _{OZ}	3-STATE Output Leakage	0 ≤ V _O ≤ 3.6V V _I = V _{IH} or V _{IL}	2.3–2.7		±10	μA
I _{OFF}	Power-OFF Leakage Current	0 ≤ (V _I , V _O) ≤ 3.6V	0		10	μA
I _{CC}	Quiescent Supply Current	V _I = V _{CC} or GND	2.3–2.7		20	μA
		V _{CC} ≤ (V _I , V _O) ≤ 3.6V (Note 6)	2.3–2.7		±20	μA
Note 6: Outputs disabled or 3-STATE only.						
DC Electrical Characteristics ($1.65V \leq V_{CC} < 2.3V$)						
Symbol	Parameter	Conditions	V _{CC} (V)	Min	Max	Units
V _{IH}	HIGH Level Input Voltage		1.65 - 2.3	0.65 × V _{CC}		V
V _{IL}	LOW Level Input Voltage		1.65 - 2.3		0.35 × V _{CC}	V
V _{OH}	HIGH Level Output Voltage	I _{OH} = –100 μA	1.65 - 2.3	V _{CC} – 0.2		V
		I _{OH} = –3 mA	1.65	1.25		V
V _{OL}	LOW Level Output Voltage	I _{OL} = 100 μA	1.65 - 2.3		0.2	V
		I _{OL} = 3 mA	1.65		0.3	V
I _I	Input Leakage Current	0 ≤ V _I ≤ 3.6V	1.65 - 2.3		±5.0	μA
I _{OZ}	3-STATE Output Leakage	0 ≤ V _O ≤ 3.6V V _I = V _{IH} or V _{IL}	1.65 - 2.3		±10	μA
I _{OFF}	Power-OFF Leakage Current	0 ≤ (V _I , V _O) ≤ 3.6V	0		10	μA
I _{CC}	Quiescent Supply Current	V _I = V _{CC} or GND	1.65 - 2.3		20	μA
		V _{CC} ≤ (V _I , V _O) ≤ 3.6V (Note 7)	1.65 - 2.3		±20	μA
Note 7: Outputs disabled or 3-STATE only.						

AC Electrical Characteristics (Note 8)								
Symbol	Parameter	$T_A = -40^\circ\text{C to } +85^\circ\text{C}, C_L = 30\text{ pF}, R_L = 500\Omega$						Units
		$V_{CC} = 3.3V \pm 0.3V$		$V_{CC} = 2.5V \pm 0.2V$		$V_{CC} = 1.8V$		
		Min	Max	Min	Max	Min	Max	
f_{MAX}	Maximum Clock Frequency	250		200		100		MHz
t_{PHL}, t_{PLH}	Prop Delay I_n to O_n (REGE = 0)	0.8	3.5	1.0	4.9	1.5	9.8	ns
t_{PHL}, t_{PLH}	Prop Delay CP to O_n (REGE = 1)	0.8	3.9	1.0	5.4	1.5	9.8	ns
t_{PHL}, t_{PLH}	Prop Delay REGE to O_n	0.8	3.9	1.0	5.4	1.5	9.8	ns
t_{PZL}, t_{PZH}	Output Enable Time	0.8	4.0	1.0	5.7	1.5	9.8	ns
t_{PLZ}, t_{PHZ}	Output Disable Time	0.8	4.1	1.0	4.6	1.5	8.3	ns
t_S	Setup Time	1.0		1.0		2.5		ns
t_H	Hold Time	0.7		0.7		1.0		ns
t_W	Pulse Width	1.5		1.5		4.0		ns
t_{OSHL}	Output to Output Skew (Note 9)		0.5		0.5		0.75	ns
t_{OSLH}								

Note 8: For $C_L = 50\text{ pF}$, add approximately 300 ps to the AC maximum specification.

Note 9: Skew is defined as the absolute value of the difference between the actual propagation delay for any two separate outputs of the same device. The specification applies to any outputs switching in the same direction, either HIGH-to-LOW (t_{OSHL}) or LOW-to-HIGH (t_{OSLH}).

Extended AC Electrical Characteristics (Note 10)				
Symbol	Parameter	$T_A = -0^\circ\text{C to } +85^\circ\text{C}, R_L = 500\Omega, V_{CC} = 3.3V \pm 0.3V$		Units
		$C_L = 50\text{ pF}$		
		Min	Max	
t_{PHL}, t_{PLH}	Prop Delay I_n to O_n (REGE = 0)	1.0	3.8	ns
t_{PHL}, t_{PLH}	Prop Delay CP to O_n (REGE = 1)	1.4	4.2	ns
t_{PHL}, t_{PLH}	Prop Delay REGE to O_n	1.0	4.2	ns
t_{PZL}, t_{PZH}	Output Enable Time	1.0	4.3	ns
t_{PLZ}, t_{PHZ}	Output Disable Time	1.0	4.4	ns
t_S	Setup Time	1.0		ns
t_H	Hold Time	0.7		ns

Note 10: This parameter is guaranteed by characterization but not tested.

Dynamic Switching Characteristics					
Symbol	Parameter	Conditions	V_{CC} (V)	$T_A = +25^\circ\text{C}$	Units
				Typical	
V_{OLP}	Quiet Output Dynamic Peak V_{OL}	$C_L = 30\text{ pF}, V_{IH} = V_{CC}, V_{IL} = 0V$	1.8	0.15	V
			2.5	0.25	
			3.3	0.35	
V_{OLV}	Quiet Output Dynamic Valley V_{OL}	$C_L = 30\text{ pF}, V_{IH} = V_{CC}, V_{IL} = 0V$	1.8	-0.15	V
			2.5	-0.25	
			3.3	-0.35	
V_{OHV}	Quiet Output Dynamic Valley V_{OH}	$C_L = 30\text{ pF}, V_{IH} = V_{CC}, V_{IL} = 0V$	1.8	1.55	V
			2.5	2.05	
			3.3	2.65	

Capacitance				
Symbol	Parameter	Conditions	$T_A = +25^\circ\text{C}$	Units
			Typical	
C_{IN}	Input Capacitance	$V_{CC} = 1.8V, 2.5V$ or $3.3V, V_I = 0V$ or V_{CC}	6	pF
C_{OUT}	Output Capacitance	$V_I = 0V$ or $V_{CC}, V_{CC} = 1.8V, 2.5V$ or $3.3V$	7	pF
C_{PD}	Power Dissipation Capacitance	$V_I = 0V$ or $V_{CC}, f = 10\text{ MHz}, V_{CC} = 1.8V, 2.5V$ or $3.3V$	20	pF

AC Loading and Waveforms

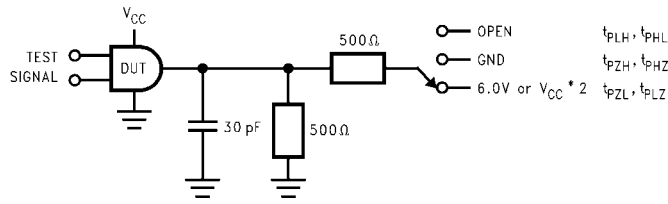

TEST	SWITCH
t_{PLH}, t_{PHL}	Open
t_{PZL}, t_{PLZ}	6V at $V_{CC} = 3.3 \pm 0.3V$; $V_{CC} \times 2$ at $V_{CC} = 2.5 \pm 0.2V$; $1.8V \pm 0.15V$
t_{PZH}, t_{PHZ}	GND

FIGURE 1. AC Test Circuit

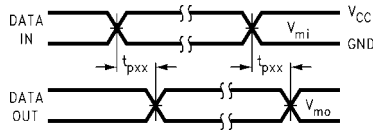

FIGURE 2. Waveform for Inverting and Non-Inverting Functions

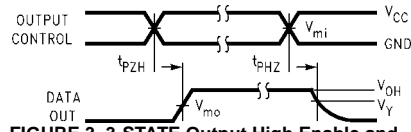

FIGURE 3. 3-STATE Output High Enable and Disable Times for Low Voltage Logic

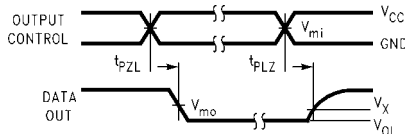

FIGURE 4. 3-STATE Output Low Enable and Disable Times for Low Voltage Logic

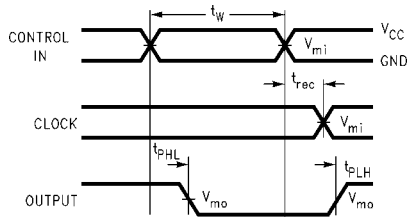

FIGURE 5. Propagation Delay, Pulse Width and t_{rec} Waveforms

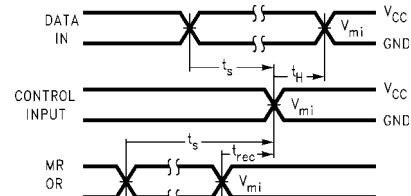
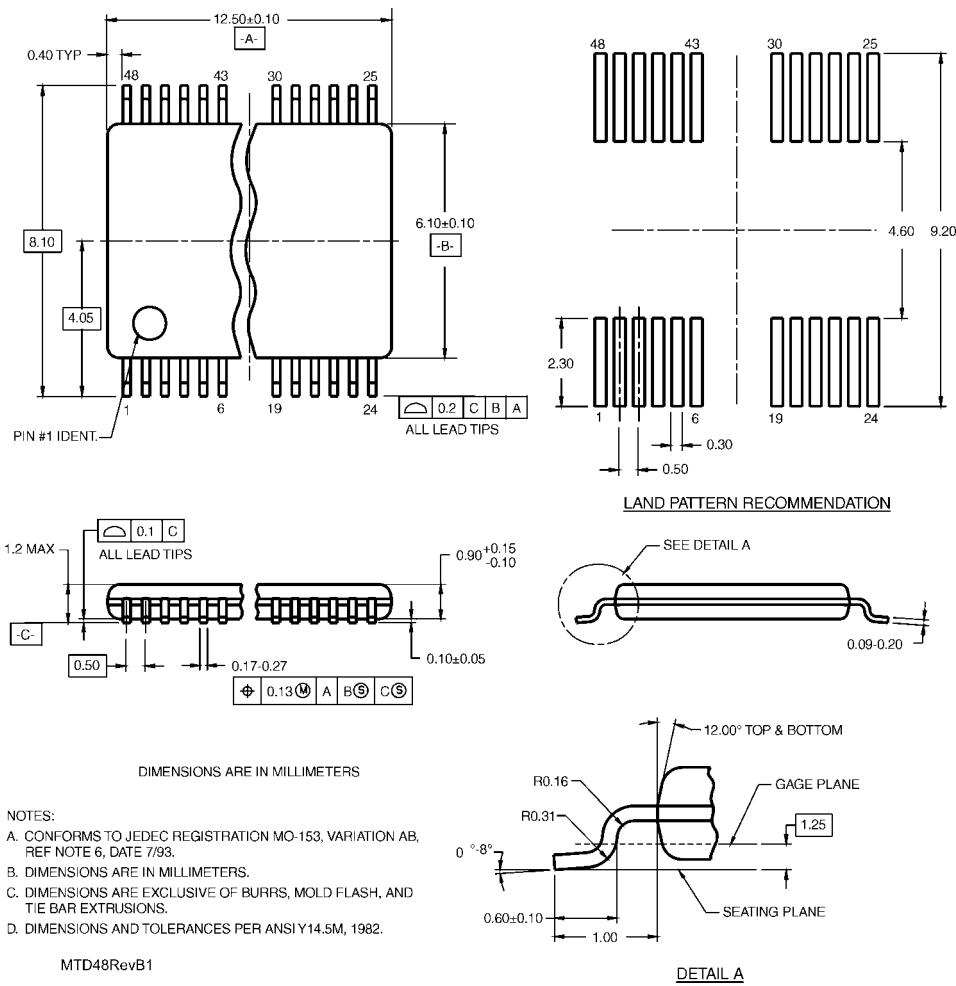

FIGURE 6. Setup Time, Hold Time and Recovery Time for Low Voltage Logic

Symbol	V_{CC}		
	$3.3V \pm 0.3V$	$2.5V \pm 0.2V$	$1.8V \pm 0.15V$
V_{mi}	1.5V	$V_{CC}/2$	$V_{CC}/2$
V_{mo}	1.5V	$V_{CC}/2$	$V_{CC}/2$
V_X	$V_{OL} + 0.3V$	$V_{OL} + 0.15V$	$V_{OL} + 0.15V$
V_Y	$V_{OH} - 0.3V$	$V_{OH} - 0.15V$	$V_{OH} - 0.15V$

Physical Dimensions inches (millimeters) unless otherwise noted



**48-Lead Thin Shrink Small Outline Package (TSSOP), JEDEC MO-153, 6.1mm Wide
Package Number MTD48**

Fairchild does not assume any responsibility for use of any circuitry described, no circuit patent licenses are implied and Fairchild reserves the right at any time without notice to change said circuitry and specifications.

LIFE SUPPORT POLICY

FAIRCHILD'S PRODUCTS ARE NOT AUTHORIZED FOR USE AS CRITICAL COMPONENTS IN LIFE SUPPORT DEVICES OR SYSTEMS WITHOUT THE EXPRESS WRITTEN APPROVAL OF THE PRESIDENT OF FAIRCHILD SEMICONDUCTOR CORPORATION. As used herein:

1. Life support devices or systems are devices or systems which, (a) are intended for surgical implant into the body, or (b) support or sustain life, and (c) whose failure to perform when properly used in accordance with instructions for use provided in the labeling, can be reasonably expected to result in a significant injury to the user.
2. A critical component in any component of a life support device or system whose failure to perform can be reasonably expected to cause the failure of the life support device or system, or to affect its safety or effectiveness.

www.fairchildsemi.com