

74VHCU04

Hex Inverter

Features

- High Speed: $t_{PD} = 3.5\text{ns}$ (typ.) at $V_{CC} = 5\text{V}$
- Low Power Dissipation: $I_{CC} = 2\mu\text{A}$ (max.) @ $T_A = 25^\circ\text{C}$
- High Noise Immunity: $V_{NIH} = V_{NIL} = 28\% V_{CC}$ (min.)
- Power down protection is provided on all inputs
- Low Noise: $V_{OLP} = 0.8\text{V}$ (max.)
- Pin and Function Compatible with 74HCU04

General Description

The VHCU04 is an advanced high speed CMOS Inverter fabricated with silicon gate CMOS technology. It achieves the high speed operation similar to equivalent Bipolar Schottky TTL while maintaining the CMOS low power dissipation.

Since the internal circuit is composed of a single stage inverter, it can be used in analog applications such as crystal oscillators. An input protection circuit ensures that 0V to 7V can be applied to the input pins without regard to the supply voltage. This device can be used to interface 5V to 3V systems and two supply systems such as battery backup. This circuit prevents device destruction due to mismatched supply and input voltages.

Ordering Information

Order Number	Package Number	Package Description
74VHCU04M	M14A	14-Lead Small Outline Integrated Circuit (SOIC), JEDEC MS-012, 0.150" Narrow
74VHCU04SJ	M14D	14-Lead Small Outline Package (SOP), EIAJ TYPE II, 5.3mm Wide
74VHCU04MTC	MTC14	14-Lead Thin Shrink Small Outline Package (TSSOP), JEDEC MO-153, 4.4mm Wide

Device also available in Tape and Reel. Specify by appending suffix letter "X" to the ordering number.

 All packages are lead free per JEDEC: J-STD-020B standard.

Connection Diagram

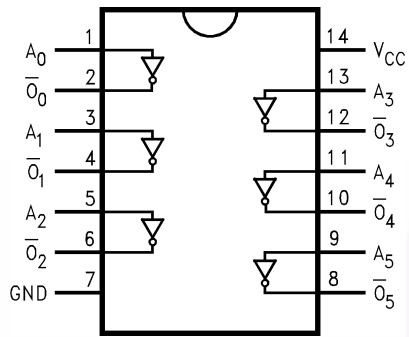

Logic Symbol

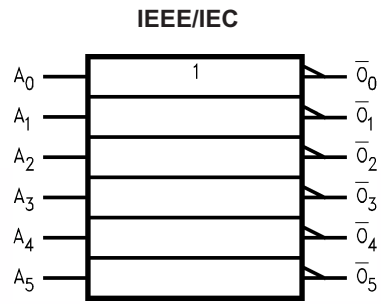

Pin Description

Pin Names	Description
A_n	Inputs
\bar{O}_n	Outputs

Truth Table

A	\bar{O}
L	H
H	L



Absolute Maximum Ratings

Stresses exceeding the absolute maximum ratings may damage the device. The device may not function or be operable above the recommended operating conditions and stressing the parts to these levels is not recommended. In addition, extended exposure to stresses above the recommended operating conditions may affect device reliability. The absolute maximum ratings are stress ratings only.

Symbol	Parameter	Rating
V_{CC}	Supply Voltage	-0.5V to +7.0V
V_{IN}	DC Input Voltage	-0.5V to +7.0V
V_{OUT}	DC Output Voltage	-0.5V to $V_{CC} + 0.5V$
I_{IK}	Input Diode Current	-20mA
I_{OK}	Output Diode Current	$\pm 20mA$
I_{OUT}	DC Output Current	$\pm 25mA$
I_{CC}	DC V_{CC}/GND Current	$\pm 50mA$
T_{STG}	Storage Temperature	-65°C to +150°C
T_L	Lead Temperature (Soldering, 10 seconds)	260°C

Recommended Operating Conditions⁽¹⁾

The Recommended Operating Conditions table defines the conditions for actual device operation. Recommended operating conditions are specified to ensure optimal performance to the datasheet specifications. Fairchild does not recommend exceeding them or designing to absolute maximum ratings.

Symbol	Parameter	Rating
V_{CC}	Supply Voltage	2.0V to +5.5V
V_{IN}	Input Voltage	0V to +5.5V
V_{OUT}	Output Voltage	0V to V_{CC}
T_{OPR}	Operating Temperature	-40°C to +85°C

Note:

- Unused inputs must be held HIGH or LOW. They may not float.

DC Electrical Characteristics

Symbol	Parameter	V _{CC} (V)	Conditions		T _A = 25°C			T _A = -40°C to +85°C		Units
					Min.	Typ.	Max.	Min.	Max.	
V _{IH}	HIGH Level Input Voltage	2.0			1.70			1.70		V
		3.0–5.5			0.8 x V _{CC}			0.8 x V _{CC}		
V _{IL}	LOW Level Input Voltage	2.0					0.30		0.30	V
		3.0–5.5					0.2 x V _{CC}		0.2 x V _{CC}	
V _{OH}	HIGH Level Output Voltage	2.0	V _{IN} = V _{IL}	I _{OH} = -50μA	1.8	2.0		1.8		V
		3.0			2.7	3.0		2.7		
		4.5			4.0	4.5		4.0		
		3.0	V _{IN} = GND	I _{OH} = -4mA	2.58			2.48		
		4.5			I _{OH} = -8mA	3.94			3.80	
V _{OL}	LOW Level Output Voltage	2.0	V _{IN} = V _{IH}	I _{OL} = 50μA			0.0	0.2		0.2
		3.0				0.0	0.3		0.3	
		4.5				0.0	0.5		0.5	
		3.0	V _{IN} = V _{CC}	I _{OL} = 4mA			0.36		0.44	
		4.5			I _{OL} = 8mA			0.36		0.44
I _{IN}	Input Leakage Current	0–5.5	V _{IN} = 5.5V or GND					±0.1		±1.0
I _{CC}	Quiescent Supply Current	5.5	V _{IN} = V _{CC} or GND				2.0		20.0	μA

Noise Characteristics

Symbol	Parameter	V _{CC} (V)	Conditions	T _A = 25°C		Units
				Typ.	Limits	
V _{OLP} ⁽²⁾	Quiet Output Maximum Dynamic V _{OL}	5.0	C _L = 50pF	0.5	0.8	V
V _{OLV} ⁽²⁾	Quiet Output Minimum Dynamic V _{OL}	5.0	C _L = 50pF	-0.5	-0.8	V
V _{IHD} ⁽²⁾	Minimum HIGH Level Dynamic Input Voltage	5.0	C _L = 50pF		4.0	V
V _{ILD} ⁽²⁾	Maximum LOW Level Dynamic Input Voltage	5.0	C _L = 50pF		1.0	V

Note:

2. Parameter guaranteed by design.

AC Electrical Characteristics

Symbol	Parameter	V _{CC} (V)	Conditions	T _A = 25°C			T _A = -40°C to +85°C		Units
				Min.	Typ.	Max.	Min.	Max.	
t _{PHL} , t _{PLH}	Propagation Delay	3.3 ± 0.3	C _L = 15pF		5.0	8.9	1.0	10.5	ns
			C _L = 50pF		7.5	11.4	1.0	13.0	
		5.0 ± 0.5	C _L = 15pF		3.5	5.5	1.0	6.5	ns
			C _L = 50pF		5.0	7.0	1.0	8.0	
C _{IN}	Input Capacitance		V _{CC} = Open		5	10		10	pF
C _{PD}	Power Dissipation Capacitance		⁽³⁾		9				pF

Note:

3. C_{PD} is defined as the value of the internal equivalent capacitance which is calculated from the operating current consumption without load. Average operating current can be obtained by the equation:

$$I_{CC}(\text{opr.}) = C_{PD} \cdot V_{CC} \cdot f_{IN} + I_{CC} / 6 \text{ (per gate).}$$

Physical Dimensions

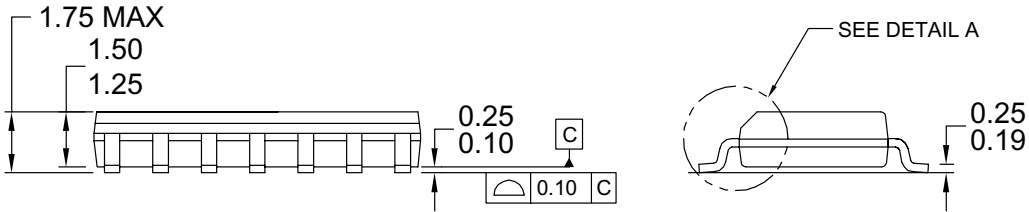
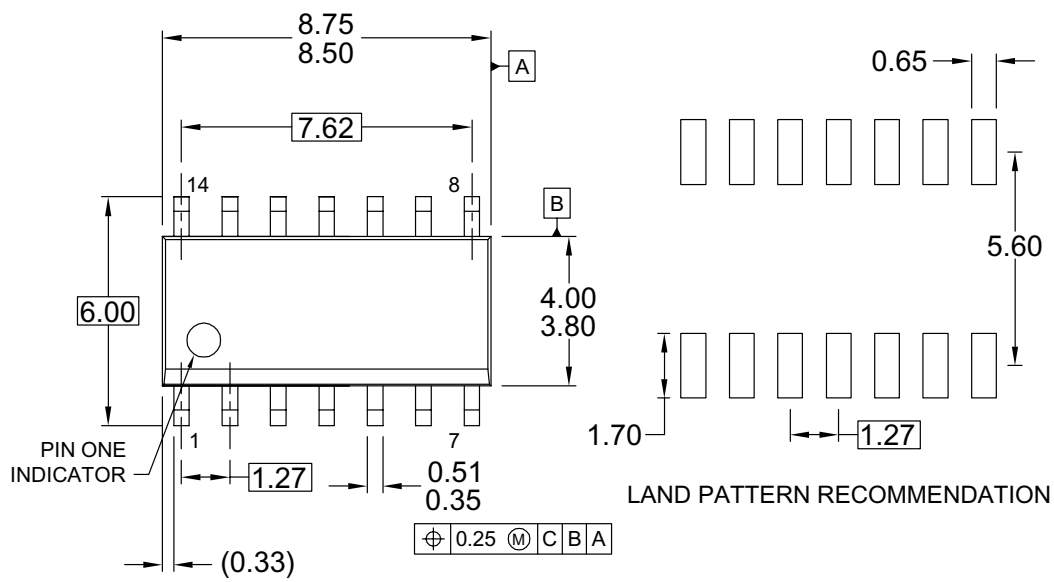

NOTES: UNLESS OTHERWISE SPECIFIED

- A) THIS PACKAGE CONFORMS TO JEDEC MS-012, VARIATION AB, ISSUE C,
- B) ALL DIMENSIONS ARE IN MILLIMETERS.
- C) DIMENSIONS DO NOT INCLUDE MOLD FLASH OR BURRS.
- D) LANDPATTERN STANDARD: SOIC127P600X145-14M
- E) DRAWING CONFORMS TO ASME Y14.5M-1994
- F) DRAWING FILE NAME: M14AREV13

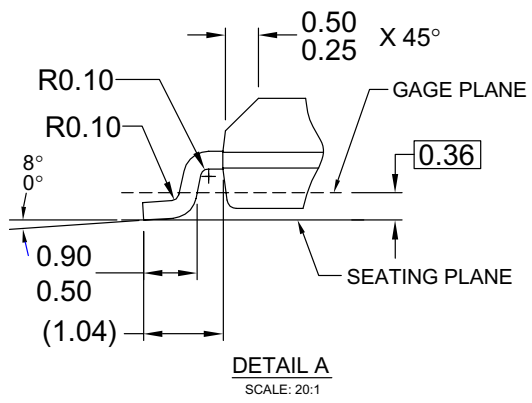

Figure 1. 14-Lead Small Outline Integrated Circuit (SOIC), JEDEC MS-012, 0.150" Narrow

Package drawings are provided as a service to customers considering Fairchild components. Drawings may change in any manner without notice. Please note the revision and/or date on the drawing and contact a Fairchild Semiconductor representative to verify or obtain the most recent revision. Package specifications do not expand the terms of Fairchild's worldwide terms and conditions, specifically the warranty therein, which covers Fairchild products.

Always visit Fairchild Semiconductor's online packaging area for the most recent package drawings:

<http://www.fairchildsemi.com/packaging/>

Physical Dimensions (Continued)

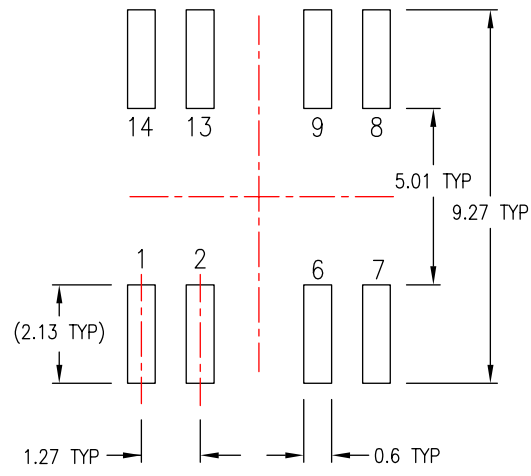
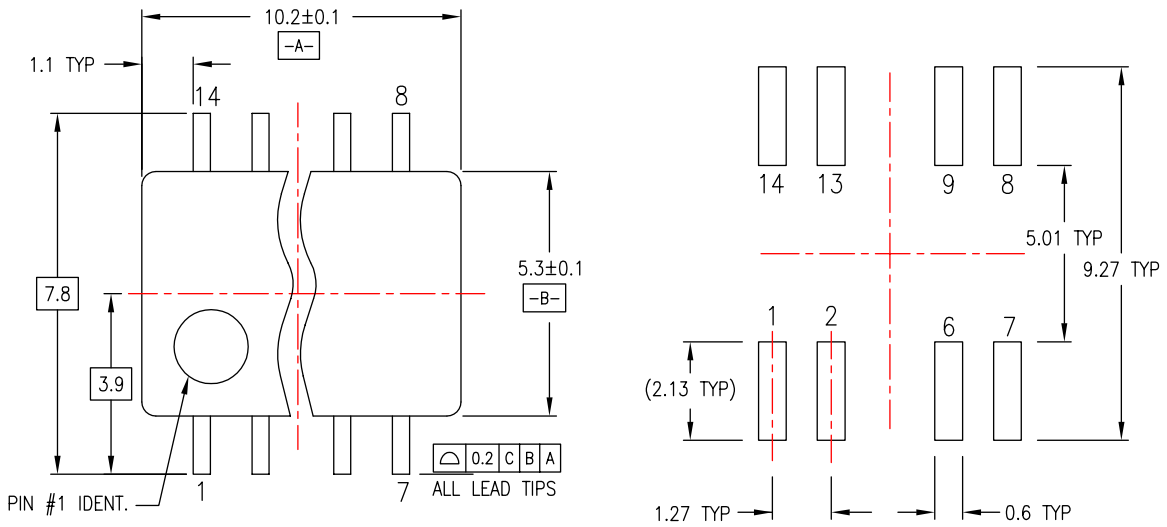

LAND PATTERN RECOMMENDATION

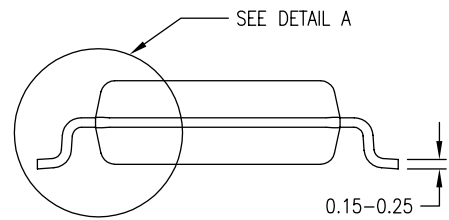
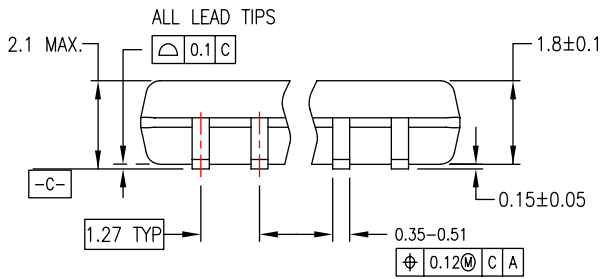

DIMENSIONS ARE IN MILLIMETERS

NOTES:

- A. CONFORMS TO EIAJ EDR-7320 REGISTRATION, ESTABLISHED IN DECEMBER, 1998.
- B. DIMENSIONS ARE IN MILLIMETERS.
- C. DIMENSIONS ARE EXCLUSIVE OF BURRS, MOLD FLASH, AND TIE BAR EXTRUSIONS.

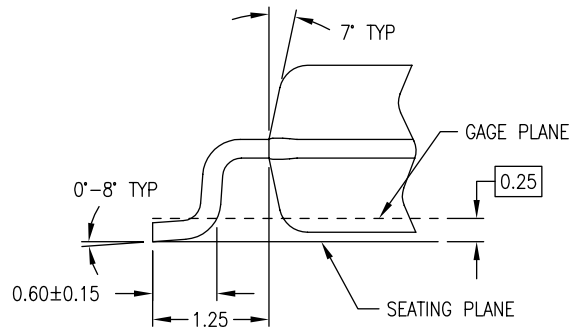

DETAIL A

M14DREVC

Figure 2. 14-Lead Small Outline Package (SOP), EIAJ TYPE II, 5.3mm Wide

Package drawings are provided as a service to customers considering Fairchild components. Drawings may change in any manner without notice. Please note the revision and/or date on the drawing and contact a Fairchild Semiconductor representative to verify or obtain the most recent revision. Package specifications do not expand the terms of Fairchild's worldwide terms and conditions, specifically the warranty therein, which covers Fairchild products.

Always visit Fairchild Semiconductor's online packaging area for the most recent package drawings:

<http://www.fairchildsemi.com/packaging/>

Physical Dimensions (Continued)

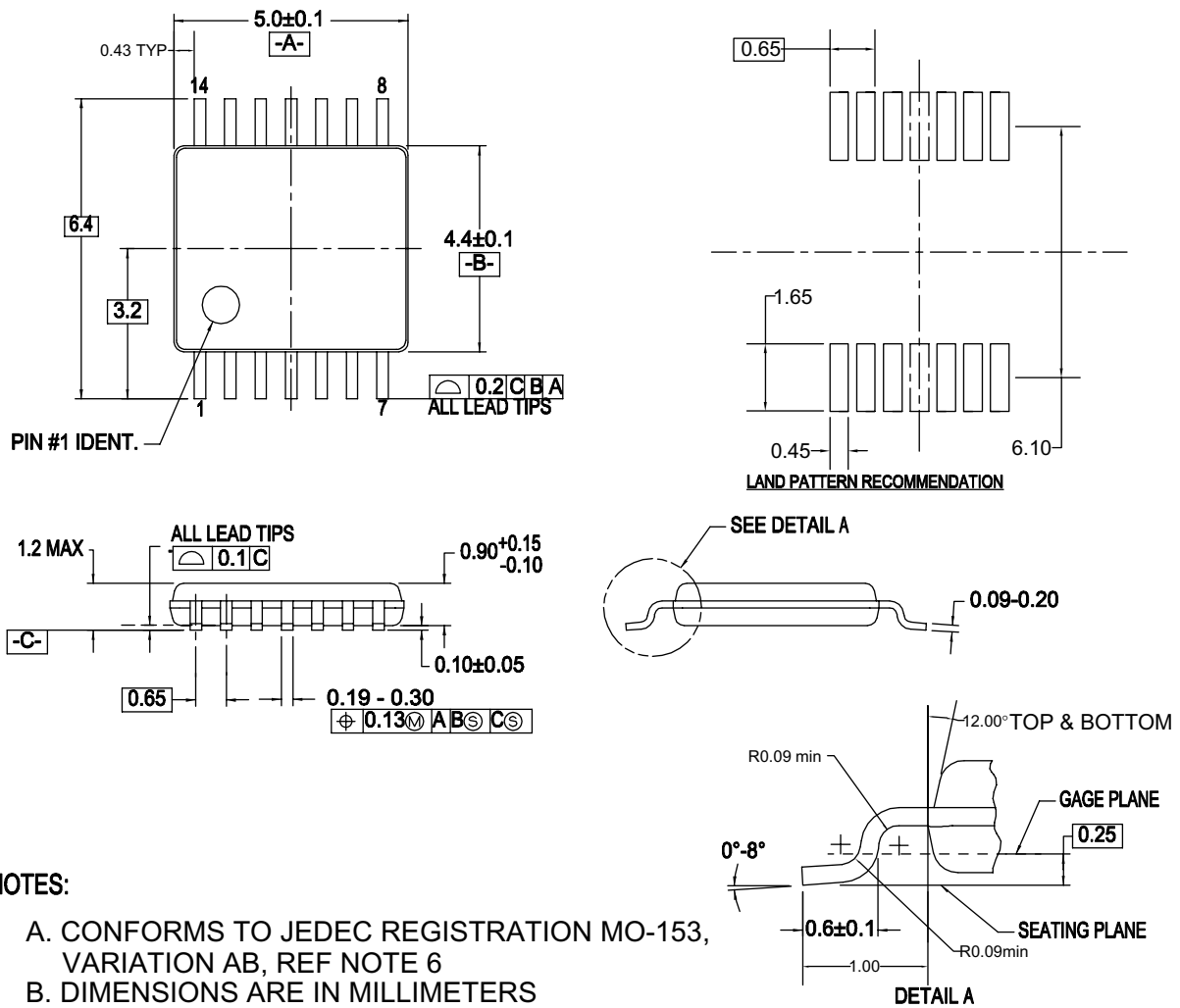

NOTES:

- A. CONFORMS TO JEDEC REGISTRATION MO-153, VARIATION AB, REF NOTE 6
- B. DIMENSIONS ARE IN MILLIMETERS
- C. DIMENSIONS ARE EXCLUSIVE OF BURRS, MOLD FLASH, AND TIE BAR EXTRUSIONS
- D. DIMENSIONING AND TOLERANCES PER ANSI Y14.5M, 1982
- E. LANDPATTERN STANDARD: SOP65P640X110-14M
- F. DRAWING FILE NAME: MTC14REV6

Figure 3. 14-Lead Thin Shrink Small Outline Package (TSSOP), JEDEC MO-153, 4.4mm Wide

Package drawings are provided as a service to customers considering Fairchild components. Drawings may change in any manner without notice. Please note the revision and/or date on the drawing and contact a Fairchild Semiconductor representative to verify or obtain the most recent revision. Package specifications do not expand the terms of Fairchild's worldwide terms and conditions, specifically the warranty therein, which covers Fairchild products.



Always visit Fairchild Semiconductor's online packaging area for the most recent package drawings:

<http://www.fairchildsemi.com/packaging/>



TRADEMARKS

The following includes registered and unregistered trademarks and service marks, owned by Fairchild Semiconductor and/or its global subsidiaries, and is not intended to be an exhaustive list of all such trademarks.

ACEx®	FPST™	PDP-SPM™	SyncFET™
Build it Now™	FRFET®	Power220®	SYSTEM GENERAL®
CorePLUS™	Global Power Resource™	Power247®	The Power Franchise®
CROSSVOLT™	Green FPS™	POWEREDGE®	the power®
CTL™	Green FPS™ e-Series™	Power-SPM™	franchise
Current Transfer Logic™	GTO™	PowerTrench®	TinyBoost™
EcoSPARK®	i-Lo™	Programmable Active Droop™	TinyBuck™
EZSWITCH™ *	IntelliMAX™	QFET®	TinyLogic®
 ™	ISOPLANAR™	QST™	TINYOPTO™
 ™	MegaBuck™	QT Optoelectronics™	TinyPower™
Fairchild®	MICROCOUPLER™	Quiet Series™	TinyPWM™
Fairchild Semiconductor®	MicroFET™	RapidConfigure™	TinyWire™
FACT Quiet Series™	MicroPak™	SMART START™	µSerDes™
FACT®	MillerDrive™	SPM®	UHC®
FAST®	Motion-SPM™	STEALTH™	Ultra FRFET™
FastvCore™ *	OPTOLOGIC®	SuperFET™	UniFET™
FlashWriter® *	OPTOPLANAR®	SuperSOT™-3	VCX™
		SuperSOT™-6	
		SuperSOT™-8	

* EZSWITCH™ and FlashWriter® are trademarks of System General Corporation, used under license by Fairchild Semiconductor.

DISCLAIMER

FAIRCHILD SEMICONDUCTOR RESERVES THE RIGHT TO MAKE CHANGES WITHOUT FURTHER NOTICE TO ANY PRODUCTS HEREIN TO IMPROVE RELIABILITY, FUNCTION, OR DESIGN. FAIRCHILD DOES NOT ASSUME ANY LIABILITY ARISING OUT OF THE APPLICATION OR USE OF ANY PRODUCT OR CIRCUIT DESCRIBED HEREIN; NEITHER DOES IT CONVEY ANY LICENSE UNDER ITS PATENT RIGHTS, NOR THE RIGHTS OF OTHERS. THESE SPECIFICATIONS DO NOT EXPAND THE TERMS OF FAIRCHILD'S WORLDWIDE TERMS AND CONDITIONS, SPECIFICALLY THE WARRANTY THEREIN, WHICH COVERS THESE PRODUCTS.

LIFE SUPPORT POLICY

FAIRCHILD'S PRODUCTS ARE NOT AUTHORIZED FOR USE AS CRITICAL COMPONENTS IN LIFE SUPPORT DEVICES OR SYSTEMS WITHOUT THE EXPRESS WRITTEN APPROVAL OF FAIRCHILD SEMICONDUCTOR CORPORATION.

As used herein:

1. Life support devices or systems are devices or systems which, (a) are intended for surgical implant into the body or (b) support or sustain life, and (c) whose failure to perform when properly used in accordance with instructions for use provided in the labeling, can be reasonably expected to result in a significant injury of the user.
2. A critical component in any component of a life support, device, or system whose failure to perform can be reasonably expected to cause the failure of the life support device or system, or to affect its safety or effectiveness.

PRODUCT STATUS DEFINITIONS

Definition of Terms

Datasheet Identification	Product Status	Definition
Advance Information	Formative or In Design	This datasheet contains the design specifications for product development. Specifications may change in any manner without notice.
Preliminary	First Production	This datasheet contains preliminary data; supplementary data will be published at a later date. Fairchild Semiconductor reserves the right to make changes at any time without notice to improve design.
No Identification Needed	Full Production	This datasheet contains final specifications. Fairchild Semiconductor reserves the right to make changes at any time without notice to improve the design.
Obsolete	Not In Production	This datasheet contains specifications on a product that has been discontinued by Fairchild Semiconductor. The datasheet is printed for reference information only.

Rev. I32