

INPUT RECTIFIER DIODE
Lead-Free ("PbF" suffix)

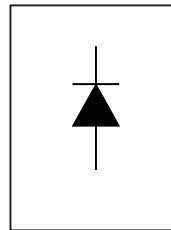

$$V_F < 1.17V @ 80A$$

$$I_{FSM} = 1450A$$

$$V_{RRM} = 800-1200V$$

Major Ratings and Characteristics

Characteristics	Values	Units
$I_{F(AV)}$ Sinusoidal waveform	80	A
V_{RRM} range	800-1200	V
I_{FSM}	1450	A
$V_F @ 80A, T_J=25^\circ C$	1.17	V
T_J	-40 to 150	$^\circ C$

Description/ Features

The 80EPS..PbF rectifier *SAFEIR* series has been optimized for very low forward voltage drop, with moderate leakage. The glass passivation technology used has reliable operation up to 150° C junction temperature. Typical applications are in input rectification and these products are designed to be used with International Rectifier Switches and Output Rectifiers which are available in identical package outlines.

Case Styles



TO-247AC

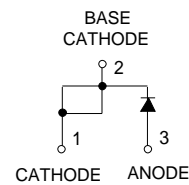

Voltage Ratings

Part Number	V_{RRM} , maximum peak reverse voltage V	V_{RSM} , maximum non repetitive peak reverse voltage V	I_{RRM} 150°C mA
80EPS08PbF	800	900	1
80EPS12PbF	1200	1300	

Absolute Maximum Ratings

Parameters	80EPS..	Units	Conditions
$I_{F(AV)}$ Max. Average Forward Current	80	A	@ $T_C = 100^\circ\text{C}$, 180° conduction half sine wave
I_{FSM} Max. Peak One Cycle Non-Repetitive Surge Current	1450	A	10ms Sine pulse, rated V_{RRM} applied
	1500		10ms Sine pulse, no voltage reapplied
I^2t Max. I^2t for fusing	10500	A^2s	10ms Sine pulse, rated V_{RRM} applied
	14000		10ms Sine pulse, no voltage reapplied
$I^2\sqrt{t}$ Max. $I^2\sqrt{t}$ for fusing	105000	$A^2\sqrt{s}$	$t = 0.1$ to 10ms, no voltage reapplied

Electrical Specifications

Parameters	80EPS..	Units	Conditions
V_{FM} Max. Forward Voltage Drop	1.17	V	@ 80A, $T_J = 25^\circ\text{C}$
r_t Forward slope resistance	3.17	$m\Omega$	$T_J = 150^\circ\text{C}$
$V_{F(TO)}$ Threshold voltage	0.73	V	
I_{RM} Max. Reverse Leakage Current	0.1	mA	$T_J = 25^\circ\text{C}$
	1.0		$T_J = 150^\circ\text{C}$

$V_R = \text{rated } V_{RRM}$

Thermal-Mechanical Specifications

Parameters	80EPS..	Units	Conditions
T_J Max. Junction Temperature Range	-40 to 150	$^\circ\text{C}$	
T_{stg} Max. Storage Temperature Range	-40 to 150	$^\circ\text{C}$	
R_{thJC} Max. Thermal Resistance Junction to Case	0.35	$^\circ\text{C/W}$	DC operation
R_{thJA} Max. Thermal Resistance Junction to Ambient	40	$^\circ\text{C/W}$	
R_{thCS} Typical Thermal Resistance, Case to Heatsink	0.2	$^\circ\text{C/W}$	Mounting surface, smooth and greased
wt Approximate Weight	6(0.21)	g(oz.)	
T Mounting Torque	Min.	6(5)	Kg-cm (lbf-in)
	Max.	12(10)	
Case Style	TO-247AC		JEDEC
Marking Device	80EPS12		

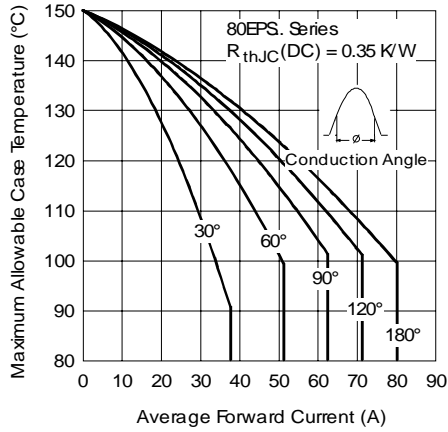

Fig. 1 - Current Rating Characteristics

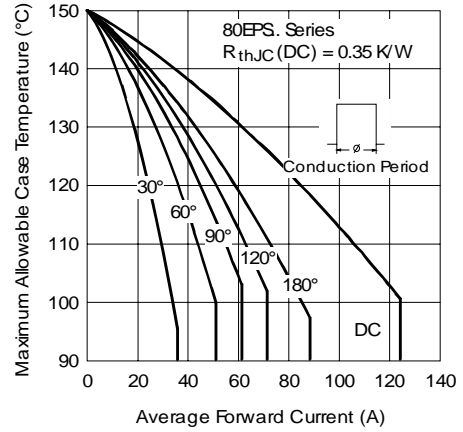

Fig. 2 - Current Rating Characteristics

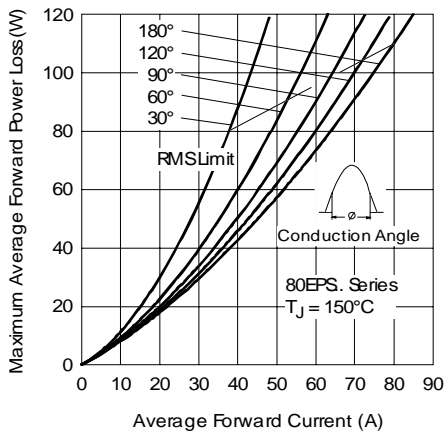

Fig. 3 - Forward Power Loss Characteristics

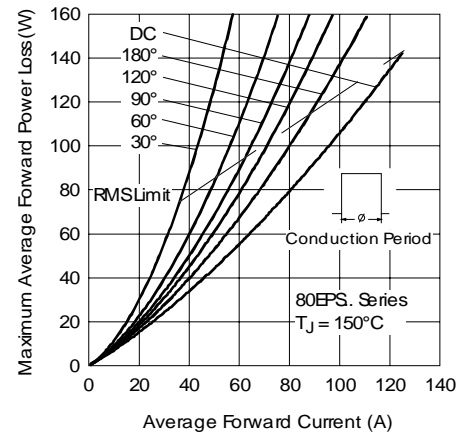

Fig. 4 - Forward Power Loss Characteristics

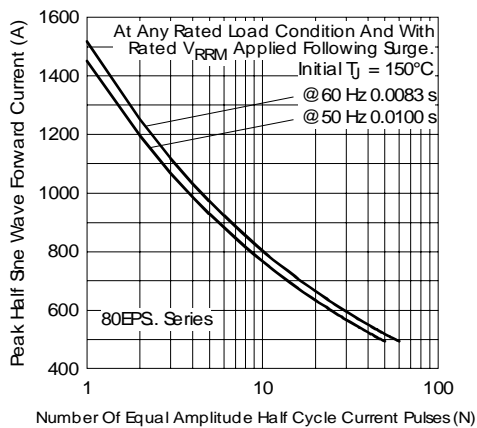

Fig. 5 - Maximum Non-Repetitive Surge Current

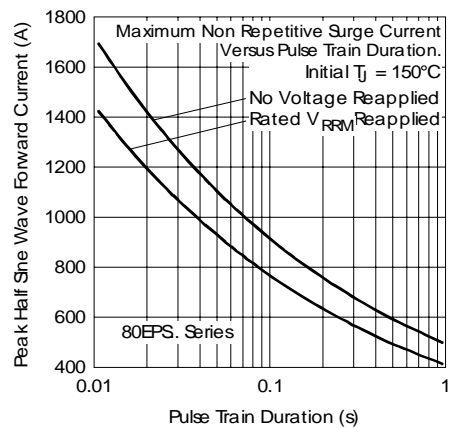

Fig. 6 - Maximum Non-Repetitive Surge Current

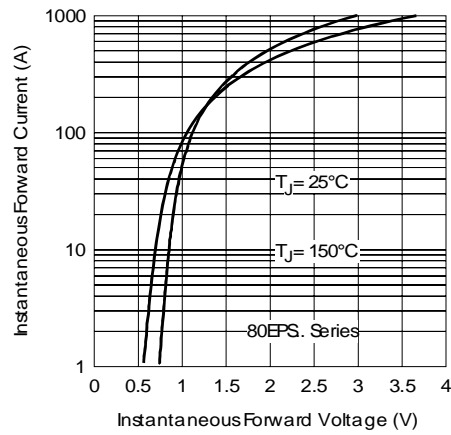

Fig. 7 - Forward Voltage Drop Characteristics

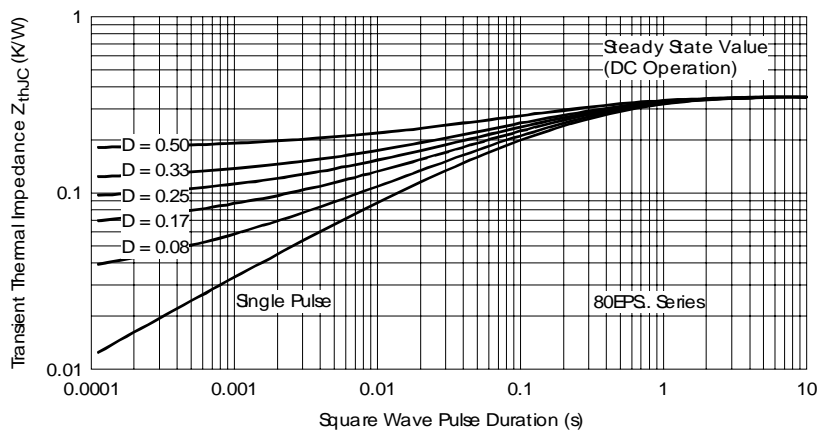
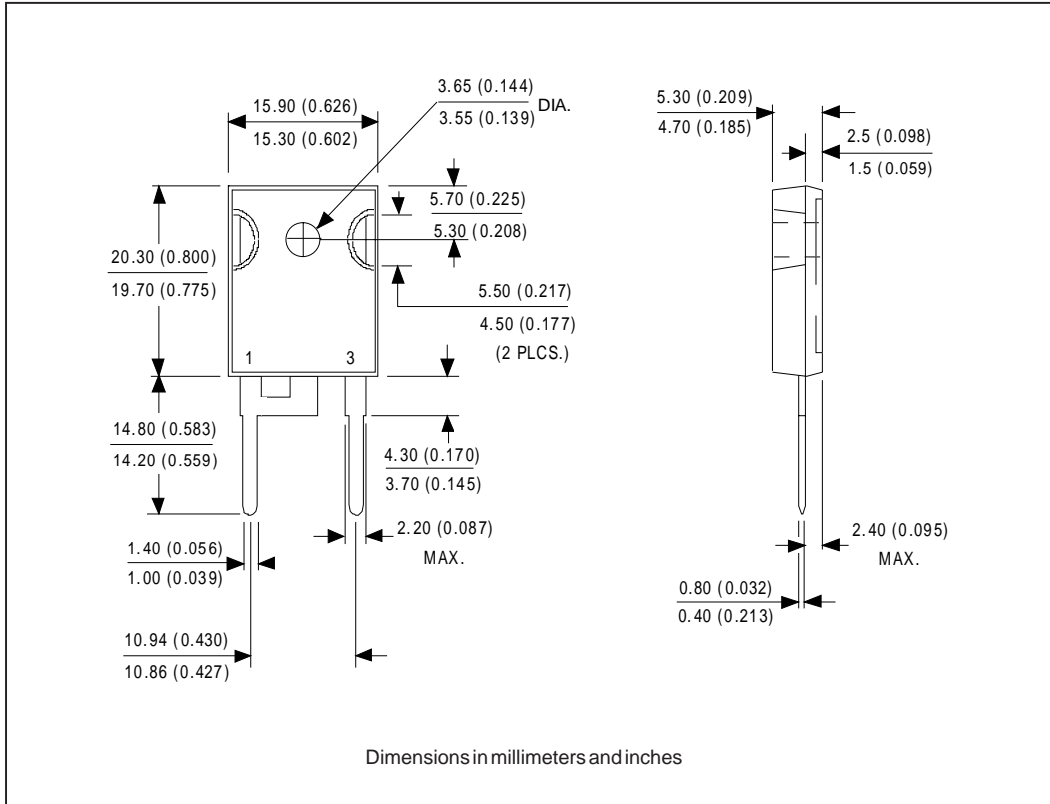
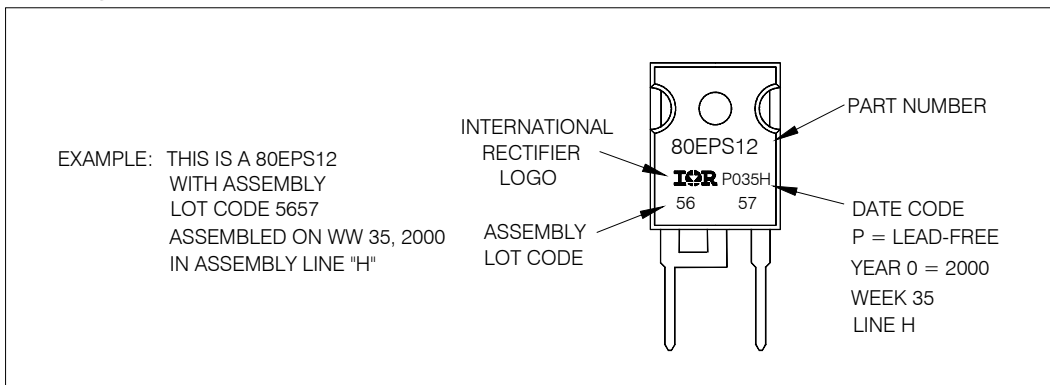

Fig. 8 - Thermal Impedance Z_{thJC} Characteristics

Outline Table



Marking Information



Ordering Information Table

Device Code	
80	E
①	②
P	S
③	④
12	PbF
⑤	⑥
1	- Current Rating (80 = 80A)
2	- Circuit Configuration: E = Single Diode
3	- Package: P = TO-247AC (Modified)
4	- Type of Silicon: S = Standard Recovery Rectifier
5	- Voltage Ratings
6	- • none = Standard Production • PbF = Lead-Free

12 = 1200V
 08 = 800V

Data and specifications subject to change without notice.
 This product has been designed and qualified for Industrial Level and Lead-Free.
 Qualification Standards can be found on IR's Web site.