

8183

Allegro[®] 8183 OUT, 3 V REGULATOR — HIGH EFFICIENCY

MicroSystems, Inc.

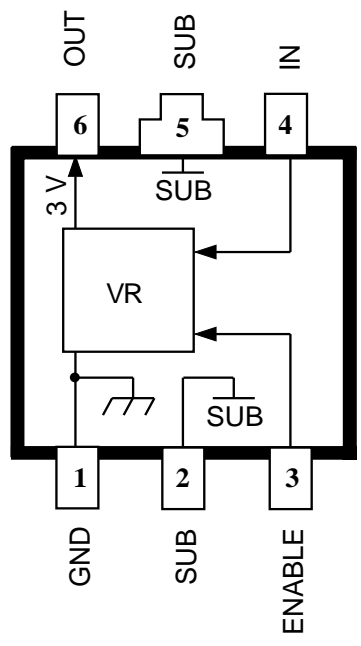

Dwg. PS-021

Designed specifically to meet the requirement for extended operation of battery-powered equipment such as cordless and cellular telephones, the A8183SLU voltage regulator offers the reduced dropout voltage and quiescent current essential for maximum battery life. Applicable also to palmtop computers and personal data assistants, the device delivers a regulated, continuous 3 V output at up to 75 mA under normal operating conditions, or to 150 mA (transient) under worst-case conditions.

A PMOS pass element provides a typical dropout voltage of only 90 mV at 60 mA of load current. The low dropout voltage permits deeper battery discharge before output regulation is lost. Furthermore, quiescent current does not increase as the dropout voltage is approached, an ideal feature in standby/resume power systems where data integrity is crucial. Regulator accuracy and excellent temperature characteristics are provided by a bandgap reference. An ENABLE input gives the designer complete control over power up, standby, or power down.

This device is supplied in a 6-lead small-outline plastic package (similar to the SOT-89/TO-243AA) for surface-mount applications. The A8183SLU is rated for operation over a temperature range of -20°C to +85°C.

FEATURES AND BENEFITS

- High Efficiency Provides Extended Battery Life
- 90 mV Typical Dropout Voltage at $I_o = 60$ mA
- 45 μ A Typical Quiescent Current at $V_i = 6$ V
Less Than 1 μ A "Sleep" Current
- Up to 150 mA Output Current
- CMOS-Compatible ON/OFF Control
For Power-Up, Standby, or Shutdown
- Internal Thermal Protection
- Surface-Mount Package

APPLICATIONS

- Cordless and Cellular Telephones
- Personal Data Assistants
- Personal Communicators
- Palmtop Computers

Always order by complete part number: **A8183SLU**

ABSOLUTE MAXIMUM RATINGS

Input Voltage, V_i	10 V
Output Current, I_o	150 mA*
Enable Input Voltage, V_E	V_i
Operating Temperature Range, T_A	-20°C to +85°C
Junction Temperature, T_J ...	+150°C†
Storage Temperature Range, T_S	-40°C to +150°C

* Output current rating is limited by input voltage, duty cycle, and ambient temperature. Under any set of conditions, do not exceed a junction temperature of +150°C. See next page.

† Fault conditions that produce excessive junction temperature will activate device thermal shutdown circuitry. These conditions can be tolerated but should be avoided.

8183 LOW-DROPOUT,



ELECTRICAL CHARACTERISTICS at $T_A = +25^\circ\text{C}$ (unless otherwise noted).

Characteristic	Symbol	Test Conditions	Limits			Units	
			Min.	Typ.	Max.		
Output Voltage	V_O	$4\text{ V} \leq V_I \leq 8\text{ V}$, $10\ \mu\text{A} \leq I_O \leq 100\ \text{mA}^*$	$T_A = +25^\circ\text{C}$	2.95	3.00	3.05	V
			$-20^\circ\text{C} \leq T_A \leq +85^\circ\text{C}$	2.90	3.00	3.10	V
		$V_I = 3\text{ V}$, $I_O = 60\ \text{mA}^*$, $-20^\circ\text{C} \leq T_A \leq +85^\circ\text{C}$	2.70	—	—	V	
Output Volt. Temp. Coeff.	α_{V_O}	$V_I = 6\text{ V}$, $I_O = 10\ \text{mA}$	—	—	± 1.0	mV/ $^\circ\text{C}$	
Line Regulation	$\Delta V_{O(\Delta V_I)}$	$6\text{ V} \leq V_I \leq 8\text{ V}$, $I_O = 1\ \text{mA}$	—	4.0	10	mV	
		$4\text{ V} \leq V_I \leq 6\text{ V}$, $I_O = 1\ \text{mA}$	—	9.5	18	mV	
Load Regulation	$\Delta V_{O(\Delta I_O)}$	$1\ \text{mA} \leq I_O \leq 100\ \text{mA}^*$, $V_I = 8\text{ V}$	—	19	30	mV	
		$1\ \text{mA} \leq I_O \leq 100\ \text{mA}^*$, $V_I = 6\text{ V}$	—	14	25	mV	
		$1\ \text{mA} \leq I_O \leq 100\ \text{mA}^*$, $V_I = 4\text{ V}$	—	8.0	20	mV	
Dropout Voltage	$V_{I,\text{min}} - V_O$	$I_O = 60\ \text{mA}^*$	—	90	150	mV	
		$I_O = 125\ \text{mA}^*$	—	190	300	mV	
Quiescent Current (GND terminal current)	I_Q	$V_I = 6\text{ V}$, $1\ \text{mA} \leq I_O \leq 100\ \text{mA}^*$, $V_E \geq 2.0\text{ V}$	—	45	60	μA	
		$V_I = 8\text{ V}$, $1\ \text{mA} \leq I_O \leq 100\ \text{mA}^*$, $V_E \geq 2.0\text{ V}$	—	50	65	μA	
	$I_{Q(\text{off})}$	$4\text{ V} \leq V_I \leq 8\text{ V}$, $V_E \leq 0.8\text{ V}$	—	—	1.0	μA	
ENABLE Input Voltage	V_{EH}	$4\text{ V} \leq V_I \leq 8\text{ V}$,	Output ON	2.0	—	—	V
	V_{EL}	$-20^\circ\text{C} \leq T_A \leq +85^\circ\text{C}$	Output OFF	—	—	0.8	V
ENABLE Input Current	I_E	$T_A \leq +85^\circ\text{C}$, $V_E = V_I = 8\text{ V}$	—	—	± 0.1	μA	
Thermal Shutdown Temp.	T_J		150	—	—	$^\circ\text{C}$	
Thermal Resistance	$R_{\theta JA}$	Mounted on 2.24" x 2.24" solder-coated copper-clad board in still air	—	258	—	$^\circ\text{C}/\text{W}$	

Typical values are at $T_A = +25^\circ\text{C}$ and are given for circuit design information only.

* Pulse test ($\leq 20\ \text{ms}$). See previous page for duty cycle limitations.

8183 LOW-DROPOUT, 3 V REGULATOR

TYPICAL CHARACTERISTICS

LOAD REGULATION

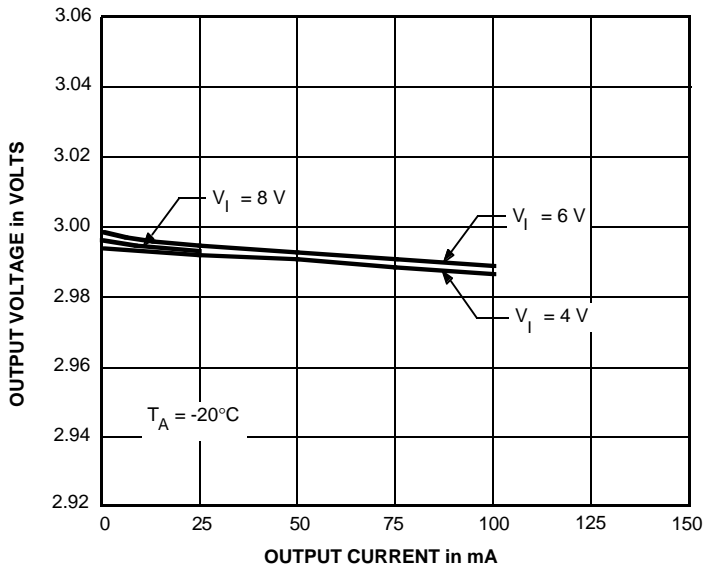

Dwg. GP-052-3

LINE REGULATION

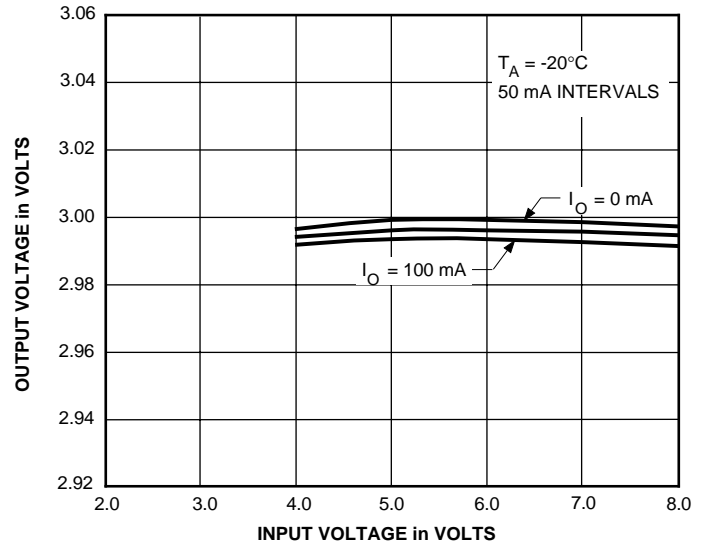

Dwg. GP-053-3

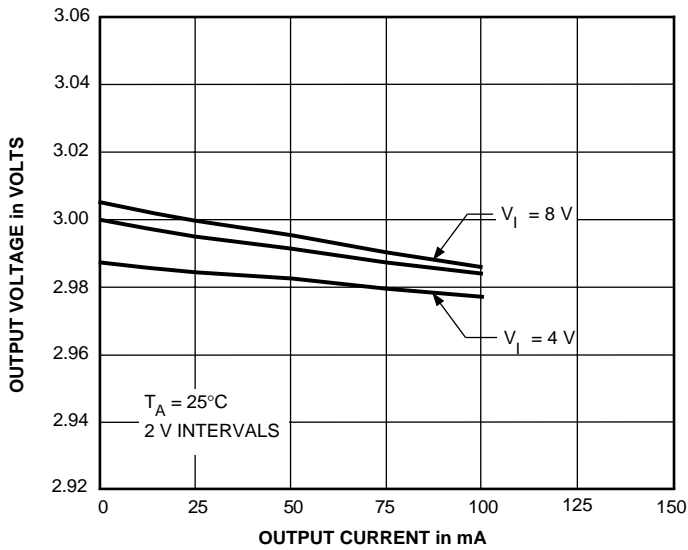

Dwg. GP-052-4

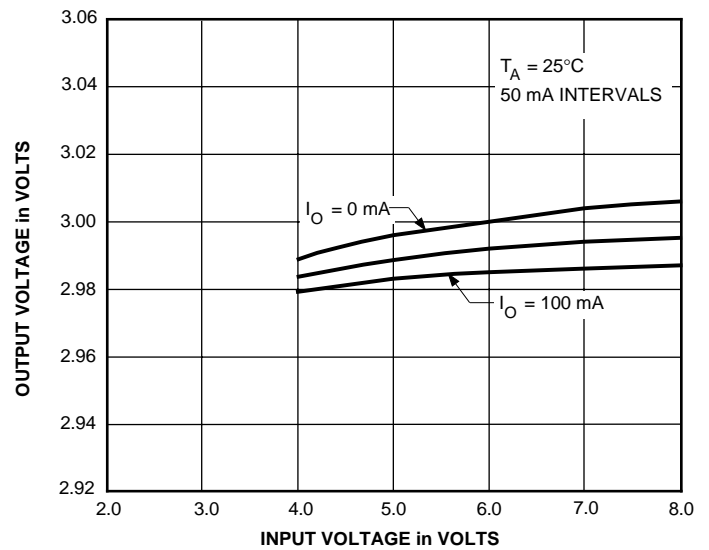

Dwg. GP-053-4

CAUTION: Maximum allowable duty cycle will be significantly less than 100% at high temperatures, at high input voltages, or at high output currents. See Maximum Allowable Output Current table.



115 Northeast Cutoff, Box 15036
Worcester, Massachusetts 01615-0036 (508) 853-5000

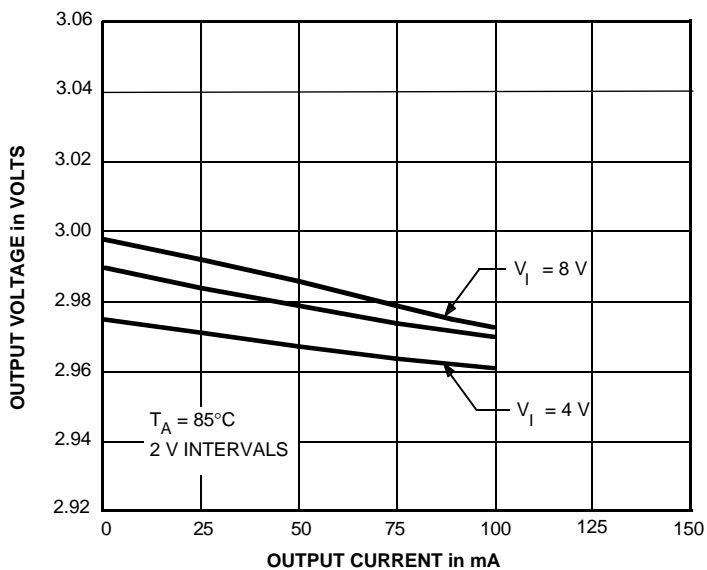

Dwg. GP-052-5

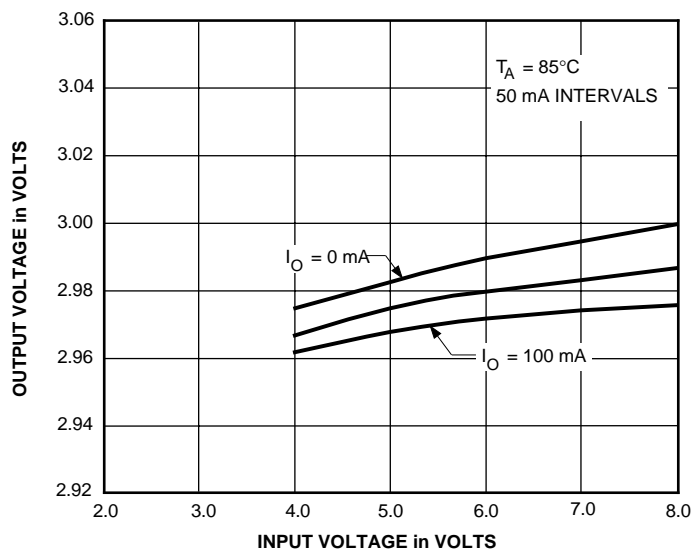

Dwg. GP-053-5

OUTPUT VOLTAGE

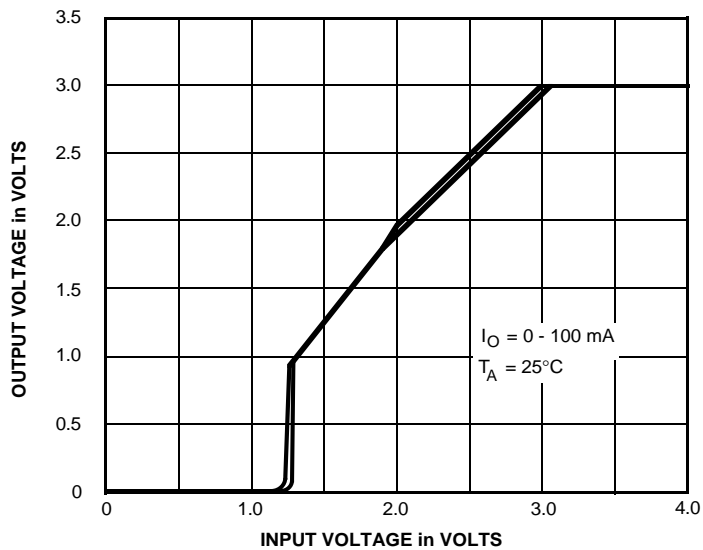

Dwg. GP-059

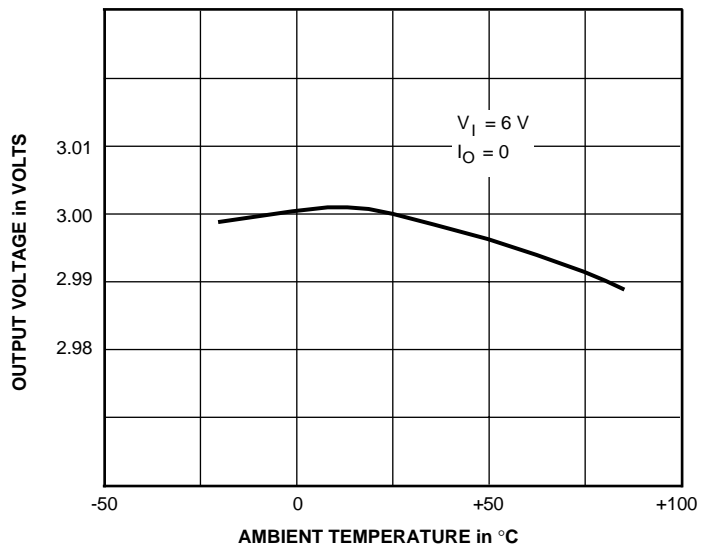

Dwg. GP-050-1

CAUTION: Maximum allowable duty cycle will be significantly less than 100% at high temperatures, at high input voltages, or at high output currents. See Maximum Allowable Output Current table.

8183 LOW-DROPOUT, 3 V REGULATOR

TYPICAL CHARACTERISTICS (cont'd)

QUIESCENT (GROUND TERMINAL) CURRENT

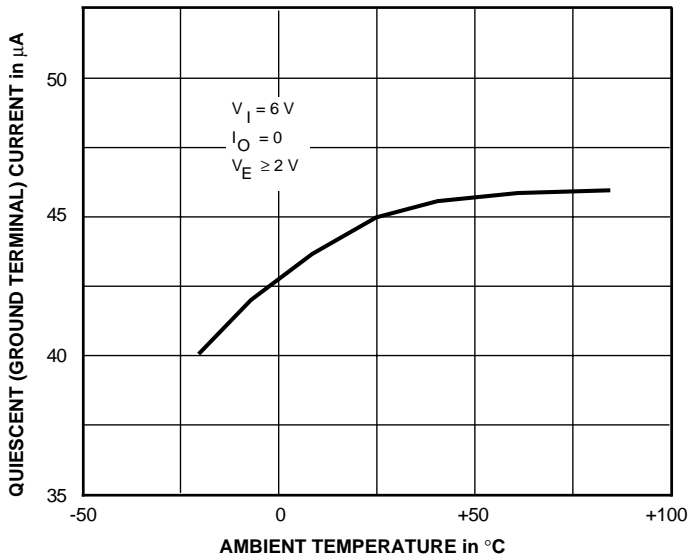

Dwg. GP-051-1

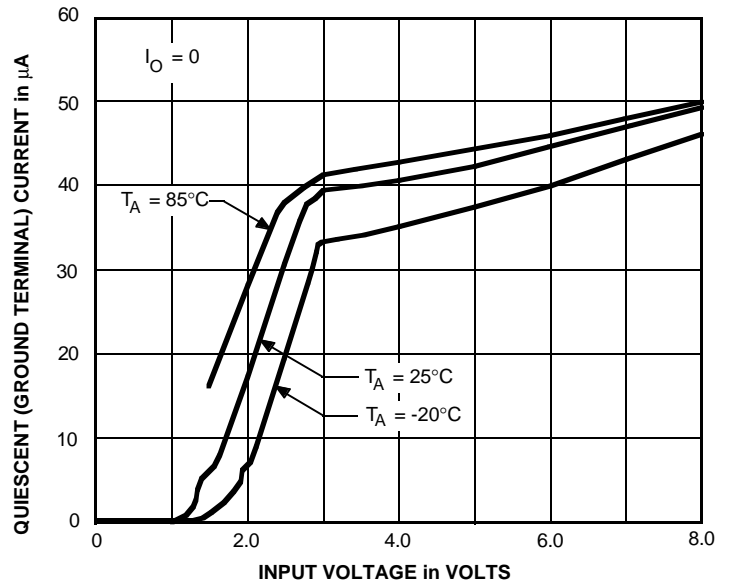

Dwg. GP-058

DROPOUT VOLTAGE

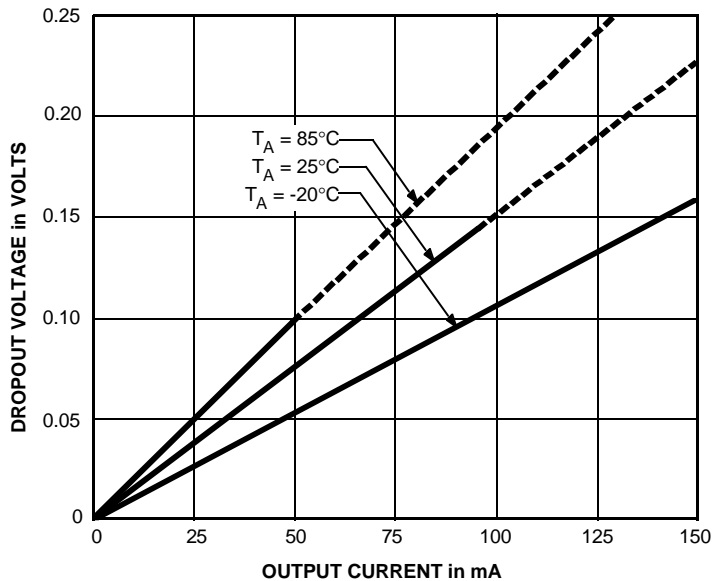

Dwg. GP-054-1

CAUTION: Maximum allowable duty cycle will be significantly less than 100% at high temperatures, at high input voltages, or at high output currents. See Maximum Allowable Output Current table.

8183 LOW-DROPOUT,



LOAD TRANSIENT PERFORMANCE

$V_I = 3.2\text{ V to }6.2\text{ V}$, C_O as specified, $T_A = 25^\circ\text{C}$

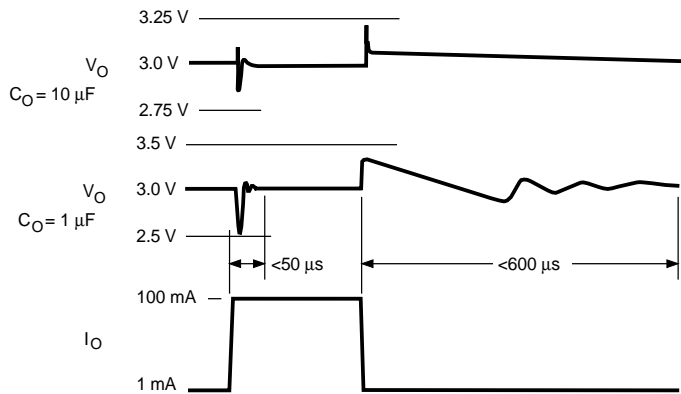

Dwg. WP-028

ENABLE TRANSIENT PERFORMANCE

$V_I = 3.2\text{ V to }6.2\text{ V}$, $C_O = 1\ \mu\text{F}$, $T_A = 25^\circ\text{C}$

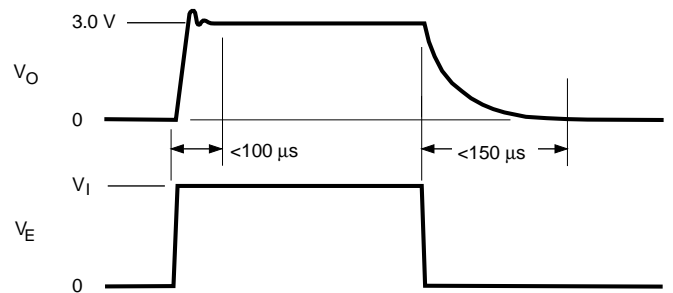

Dwg. WP-027-1

8183 LOW-DROPOUT, 3 V REGULATOR

Dimensions in Inches (Based on 1 mm = 0.03937")

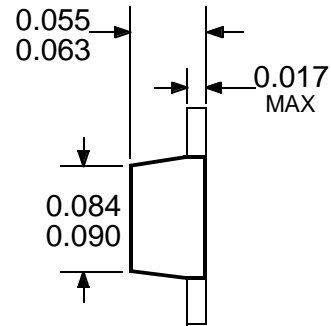
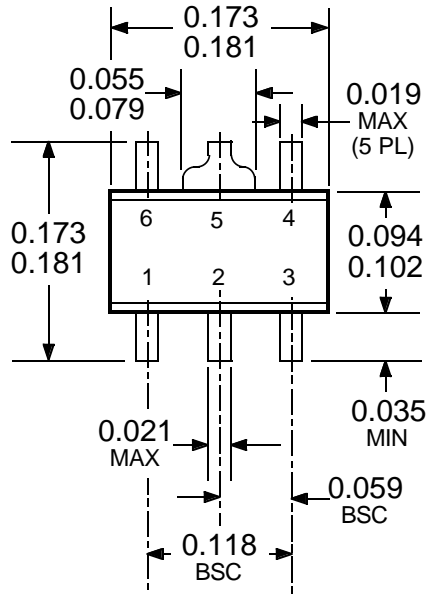

Dwg. MA-009-6 in

Dimensions in Millimeters

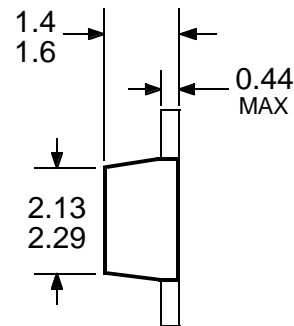
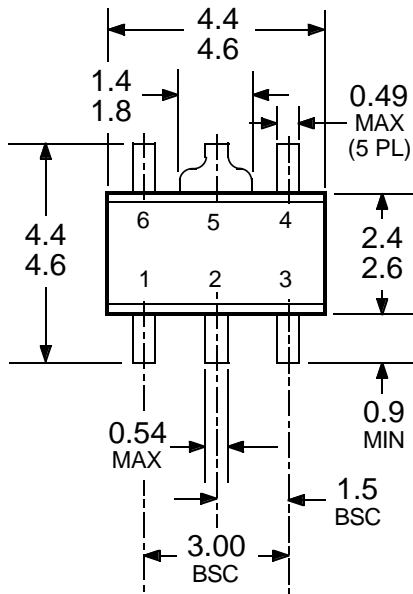

Dwg. MA-009-6 mm

Allegro MicroSystems, Inc. reserves the right to make, from time to time, such departures from the detail specifications as may be required to permit improvements in the design of its products. Components made under military approvals will be in accordance with the approval requirements.

The information included herein is believed to be accurate and reliable. However, Allegro MicroSystems, Inc. assumes no responsibility for its use; nor for any infringements of patents or other rights of third parties which may result from its use.

NOTES: 1. Lead spacing tolerance is non-cumulative.

2. Exact body and lead configuration at vendor's option within limits shown.

3. Terminal numbering is in accordance with EIA/JEDEC convention. Where EIAJ conventions apply, the tab is not numbered, resulting in terminal 6 being designated terminal 5.

