



Doc. Version	1.0
Total Page	23
Date	2008/03/27

Product Specification

4.3" COLOR TFT-LCD MODULE

MODEL NAME: A043FL01 V4

< > Preliminary Specification

< > Final Specification

Note: The content of this specification is subject to change.

© 2006 AU Optronics
All Rights Reserved,
Do Not Copy.



Record of Revision

Version	Revise Date	Page	Content
0.0	2007/06/18		First draft.
0.1	2007/12/06		Update drawing and packing form
1.0	2008/03/27	5	Modify Outline Drawing
		6~7	Modify Pin Assignment
		7	Modify Power Supply Spec
		8	Modify Application Circuit
		11	Remove Register Setting Description
		12	Update transmittance



Contents:

- A. General Description 4**
- B. Features 4**
- C. Physical Specifications..... 4**
- D. Outline Dimension..... 5**
- E. Electrical Specifications 6**
 - 1. Pin Assignment 6
 - 2. Absolute Maximum Ratings 7
 - 3. Electrical Characteristics 7
 - 4. Suggested Application Circuit 8
 - 5. AC Timing 9
 - a. Power on/off sequence..... 9
 - b. Timing Condition 10
 - c. Timing Diagram 11
- F. Optical specifications (Note 1, 2)..... 12**
- G. Reliability Test Items 14**
- H. Packing Form..... 15**

A. General Description

A043FL01 V4 is an LTPS transmissive type Thin Film Transistor Liquid crystal Display (TFT-LCD) semi-module. This model is composed of a TFT-LCD, a driver and an FPC.

B. Features

- 4.3-inch display
- WQVGA resolution in RGB stripe dot arrangement
- DC/DC integrated
- Interfaces: parallel RGB 24-bit
- Wide viewing angle
- Green design

C. Physical Specifications

NO.	Item	Unit	Specification	Remark
1	Display Resolution	dot	480 RGB (H)×272(V)	
2	Active Area	mm	95.04(H)×53.856(V)	
3	Screen Size	inch	4.3(Diagonal)	
4	Dot Pitch	mm	0.066(H)×0.198(V)	
5	Color Configuration	--	R. G. B. Stripe	Note 1
6	Color Depth	--	16.7M Colors	
7	Overall Dimension	mm	99.24(H) × 61.46(V) × 1.43(T)	
8	Weight	g	TBD	
9	Display Mode	--	Normally White	
10	Gray Level Inversion Direction		6 O'clock	

Note 1: Below figure shows dot stripe arrangement.

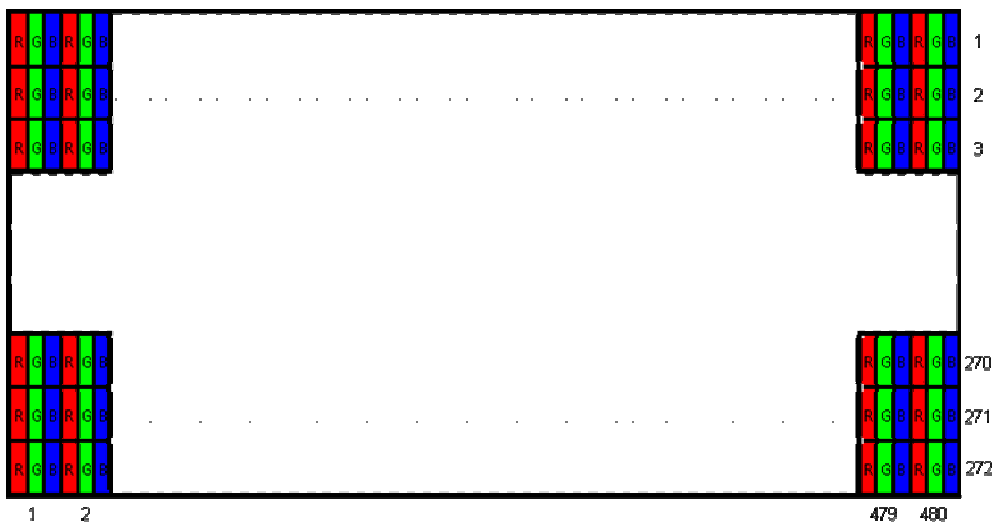



D. Outline Dimension

- Notes:
 1. General tolerance $\pm 0.2\text{mm}$
 2. The bending radius of FPC should be longer than 0.6mm

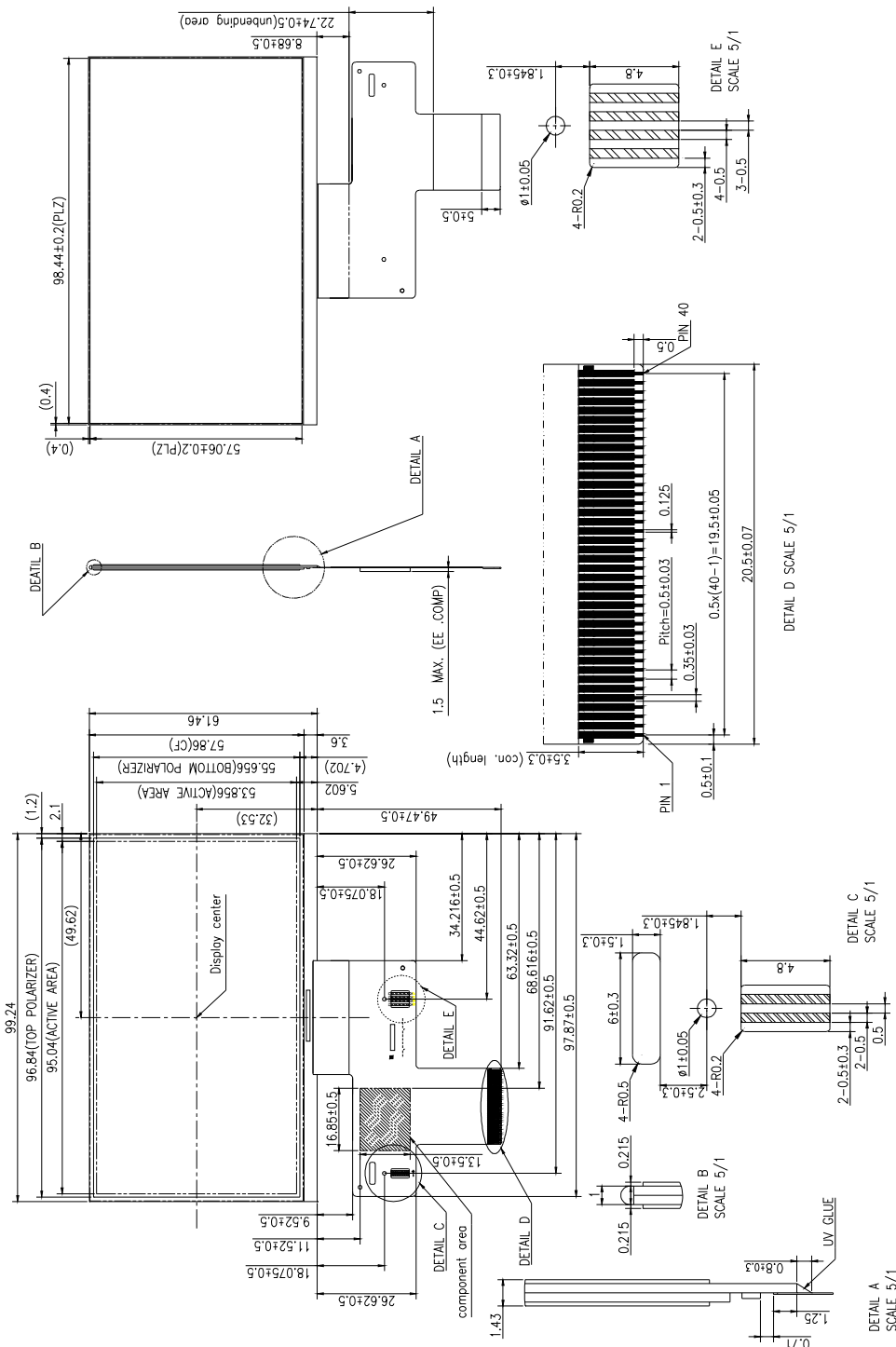

ALL RIGHTS STRICTLY RESERVED. ANY PORTION OF THIS PAPER SHALL NOT BE REPRODUCED, COPIED, OR TRANSFORMED TO ANY OTHER FORMS WITHOUT PERMISSION FROM AU OPTRONICS CORP.

E. Electrical Specifications

1. Pin Assignment

No.	Pin Name	I/O	Description	Remarks
1	VLED-	PI	LED backlight cathode	
2	VLED+	PI	LED backlight anode	
3	GND	G	Ground	
4	VDD	P	Power Supply	
5	R0	I	Red Data (LSB)	
6	R1	I	Red Data	
7	R2	I	Red Data	
8	R3	I	Red Data	
9	R4	I	Red Data	
10	R5	I	Red Data	
11	R6	I	Red Data	
12	R7	I	Red Data (MSB)	
13	G0	I	Green Data (LSB)	
14	G1	I	Green Data	
15	G2	I	Green Data	
16	G3	I	Green Data	
17	G4	I	Green Data	
18	G5	I	Green Data	
19	G6	I	Green Data	
20	G7	I	Green Data (MSB)	
21	B0	I	Blue Data (LSB)	
22	B1	I	Blue Data	
23	B2	I	Blue Data	
24	B3	I	Blue Data	
25	B4	I	Blue Data	
26	B5	I	Blue Data	
27	B6	I	Blue Data	
28	B7	I	Blue Data (MSB)	
29	GND	G	Ground	
30	DCLK	I	Pixel Clock	
31	DISP	I	Display On/Off Signal	
32	HSYNC	I	Horizontal Synchronizing Signal	
33	VSYNC	I	Vertical Synchronizing Signal	

34	DE	I	Data Enable	
35	NC		Not Connected	
36	GND	G	Ground	
37	NC	-	Reserved for Touch Panel	
38	NC	-	Reserved for Touch Panel	
39	NC	-	Reserved for Touch Panel	
40	NC	-	Reserved for Touch Panel	

I: Digital signal input, O: Digital signal output, G: GND, PI: Power input, C: Capacitor

2. Absolute Maximum Ratings

Items	Symbol	Values		Unit	Condition
		Min.	Max.		
Power Voltage	VDD	-0.3	4.5	V	
Input Signal Voltage	V _i	0.8* VDD	VDD	V	
	V _I	GND	0.2* VDD	V	

Note 1.If the operating condition exceeds the absolute maximum ratings, the TFT-LCD module may be damaged permanently. Also, if the module operated with the absolute maximum ratings for a long time, its reliability may drop.

3. Electrical Characteristics

The following items are measured under stable condition and suggested application circuit.

Parameter	Symbol	Min	Typ	Max	Unit	Notes
Power Supply	VDD	3.1	3.3	3.5	V	
Frame Frequency	f _{Frame}		60	70	Hz	
Dot Data Clock	DCLK		9.2	TBD	MHz	

4. Suggested Application Circuit

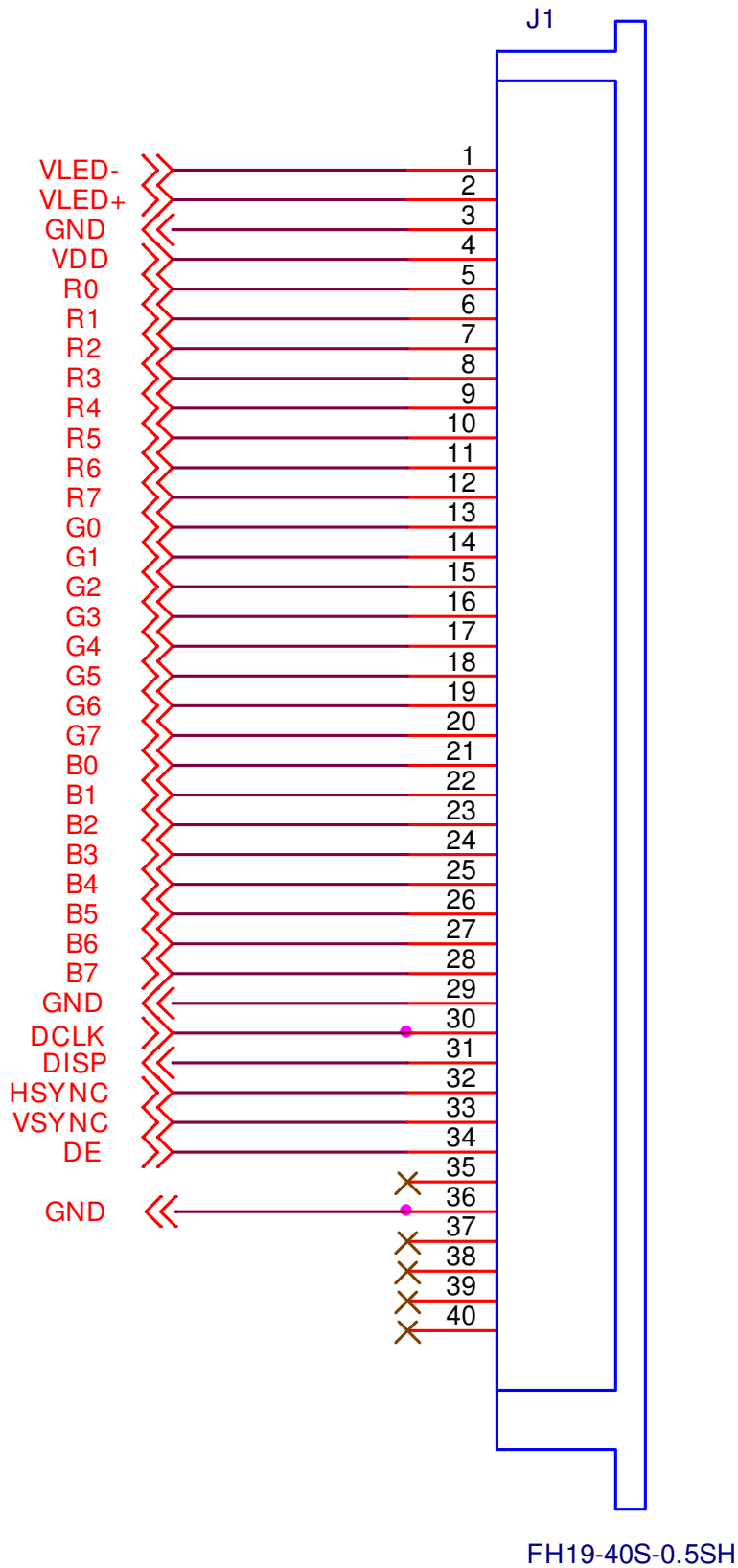

5. AC Timing

a. Power on/off sequence

Power On (Display ON; Standby Disabling)

The LCD driver is in default standby mode after VDD/VDDIO power-on, and set the register DISP to high to disable the standby mode is required for normal operation. When the standby mode is disabled, a build-in power on sequence is started. The driver IC analog power VDD2 is turned on first, and then the LCD positive and negative power supplies VGH/VGL are pumped, and followed by the LED power. Since we recommend using external LED driver, the backlight power should be provided at this time. Please refer to power on sequence for the detail timing.

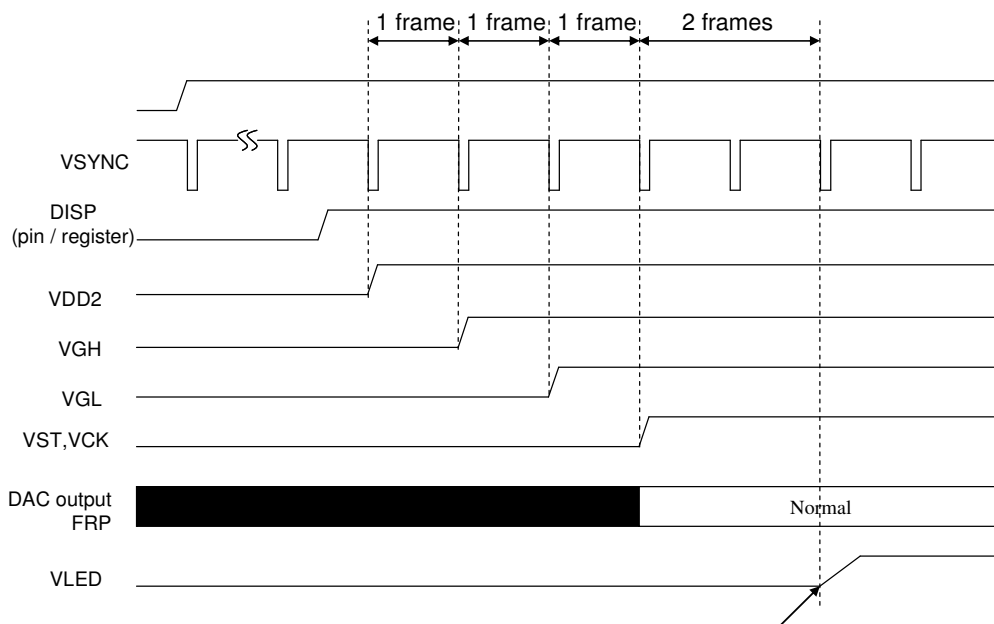

Power-Off (Display Off; Standby Enabling)

When the register DISP is set to low to enable standby mode, a build-in power off sequence is started. Please also refer to the power off sequence for the detail timing.

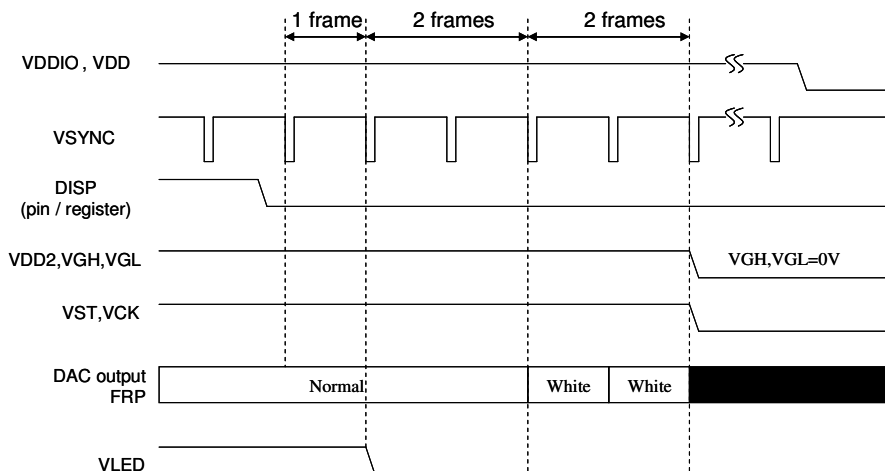

Low-voltage reset

Following figure suggests for low voltage reset function on power on sequence. When low voltage reset function enable, all the registers are loaded to default setting.

- A. The rising time (10%-90%) of VDD needs larger than 1ms.
- B. After power off, VDD needs to be keep under 0.5V more than 500ms, then it can be power on again.

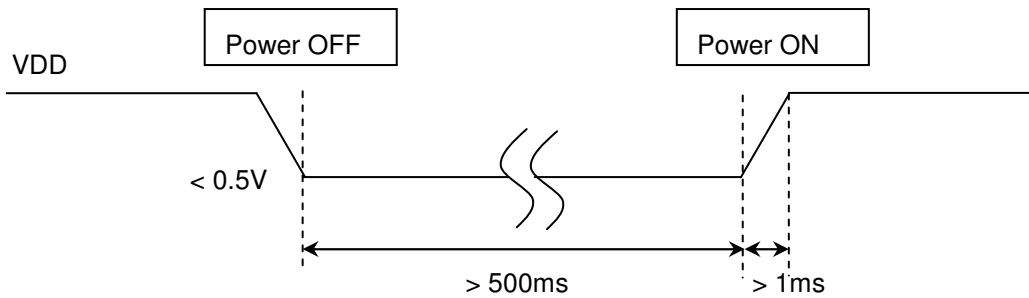

b. Timing Condition

Parameter		Symbol	Min.	Typ.	Max.	Unit.	Remark
Clock	Frequency	1/Tc	--	9.2	10	MHz	
	High Time	TCH	40	--	--	ns	
	Low Time	TCL	40	--	--	ns	
Data	Setup Time	TDS	10	--	--	ns	
	Hold Time	TDH	3	--	--	ns	
DE	Setup Time	TDES	10	--	--	ns	
	Hold Time	TDEH	3	--	--	ns	
Frame Frequency	Cycle	tv		16.7		ms	
1 Frame Scanning Time	Cycle	tv	--	288	--	H	
	Display Period	tvd	272			H	
	Front porch	tvf	2	4		H	
	Pulse width	tvp	1	10		H	
	Back porch	tvb	2	2		H	
1 Line Scanning Time	Cycle	th	490	533	545	DCLK	
	Display Period	thd	480			DCLK	
	Front porch	thf	2	8		DCLK	
	Pulse width	thp	1	41		DCLK	
	Back porch	thb	2	4		DCLK	

c. Timing Diagram

Vertical Timing of Input

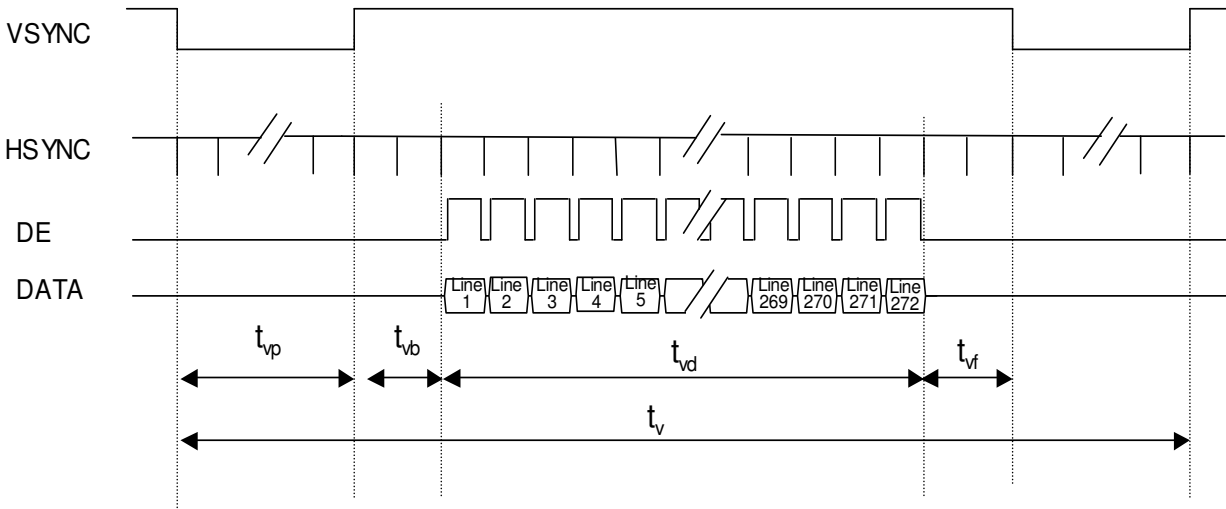

Horizontal Timing of Input

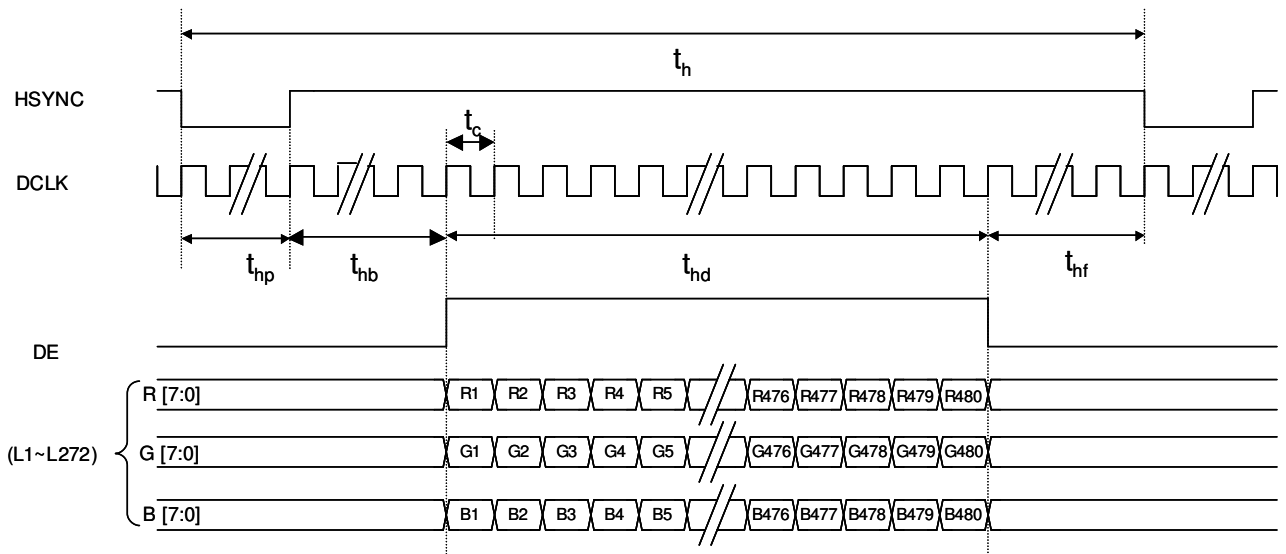

F. Optical specifications (Note 1, 2)

Item	Symbol	Condition	Min.	Typ.	Max.	Unit	Remark
Response Time							
Rise	Tr	$\theta = 0^\circ$	-	15	25	ms	Note 3
Fall	Tf		-	20	30	ms	
Contrast ratio	CR	At optimized viewing angle	200	300	-		Note 5, 6
Viewing Angle							
Top		CR ≥ 10	30	40	-	deg.	Note 7, 8
Bottom			45	55	-		
Left			50	60	-		
Right			50	60	-		
Transmittance				7.1		%	
White Chromaticity	X	$\theta = 0^\circ$		TBD			
	y	$\theta = 0^\circ$		TBD			

Note 1: Measurement should be performed in the dark room, optical ambient temperature =25°C, and backlight current $I_L=20$ mA

Note 2: To be measured on the center area of panel with a field angle of 1°by Topcon luminance meter BM-7, after 10 minutes operation.

Note 3: Definition of response time:

The output signals of photo detector are measured when the input signals are changed from “black” to “white”(falling time) and from “white” to “black”(rising time), respectively.

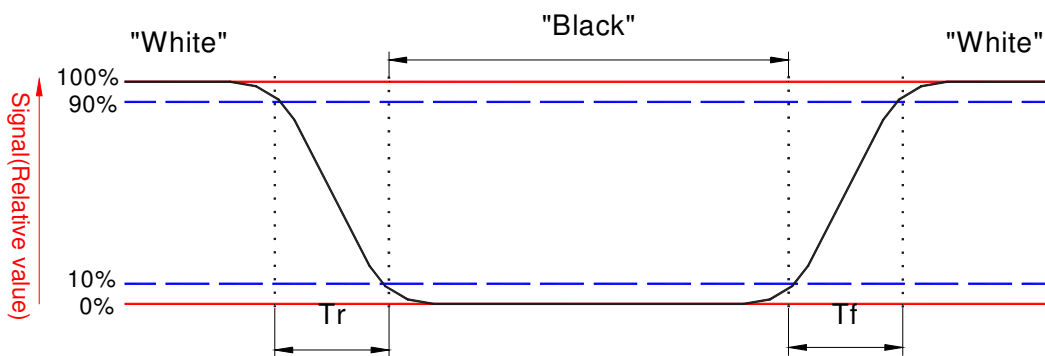

Note 4. From liquid crystal characteristics, response time will become slower and the color of panel will become darker when ambient temperature is below 25°C.

$$\text{Contrast ratio} = \frac{\text{Photo detector output when LCD is at "White" state}}{\text{Photo detector output when LCD is at "Black" state}}$$

Note 5. Contrast ratio is calculated with the following formula.

Note 6. White $V_i=V_{i50} \mu 1.5V$

Black $V_i = V_{i50} \pm 2.0V$

“±” means that the analog input signal swings in phase with COM signal.

“μ” means that the analog input signal swings out of phase with COM signal.

V_{i50} :The analog input voltage when transmission is 50%

The 100% transmission is defined as the transmission of LCD panel when all the input terminals of module are electrically opened.

Note 7. Definition of viewing angle: refer to figure as below.

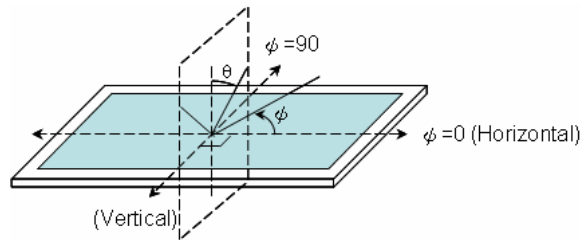

Note 8. The viewing angles are measured at the center area of the panel when all the input terminals of LCD panel are electrically opened.

Note 9. Color Filter white chromaticity is for reference. Actual panel white chromaticity varies based on different light sources.

G. Reliability Test Items

No.	Test items	Conditions		Remark
1	High Temperature Storage	Ta= 80□	240Hrs	
2	Low Temperature Storage	Ta= -30□	240Hrs	
3	High Temperature Operation	Ta= 70□	240Hrs	
4	Low Temperature Operation	Ta= -20□	240Hrs	
5	High Temperature & High Humidity	Ta= 60□. 90% RH	240Hrs	Operation
6	Heat Shock	-25□~70□, 50 cycle, 2Hrs/cycle		Non-operation
7	Vibration (With Carton)	Random vibration: 0.015G ² /Hz from 5~200Hz -6dB/Octave from 200~500Hz		IEC 68-34
8	Drop (With Carton)	Height: 60cm 1 corner, 3 edges, 6 surfaces		

Note 1: Ta: Ambient temperature.

Note 2: In the standard condition, there is not display function NG issue occurred. All the cosmetic specification is judged before the reliability stress.



H. Packing Form