



DESCRIPTION

The A6154 series is a set of low power high voltage regulators implemented in CMOS technology. It can operate from 2.5V to 36V. Which can provide 150mA output current. The device allows input voltage as high as 36V.

The A6154 series is available in several fixed 3.0V, 3.3V, 3.6V and 5.0V output voltage. CMOS technology ensures low dropout voltage and ultralow quiescent current.

The A6154 is available in SOT-23, SOT-23S, SOT-25 and SOT89-3 packages.

ORDERING INFORMATION

Package Type	Part Number	
SOT-23 SPQ: 3,000pcs/Reel	E3	A6154E3R-XX
		A6154E3VR-XX
SOT-23S SPQ: 3,000pcs/Reel	E3S	A6154E3SR-XX
		A6154E3SVR-XX
SOT-25 SPQ: 3,000pcs/Reel	E5	A6154E5R-XX
		A6154E5VR-XX
SOT89-3 SPQ: 1,000pcs/Reel	K3	A6154K3R-XXZ
		A6154K3VR-XXZ
Note	XX: Output Voltage 30=3.0V; 33=3.3V Z: Pin Type A or B V: Halogen free Package R: Tape & Reel	
AiT provides all RoHS products		

FEATURES

- Ultralow Quiescent Current I_Q :
2.5 μ A Typical at Light Loads
5 μ A Maximum at Light Loads
- 150mA Nominal Output Current
- High Input Voltage (up to 36V)
- Fixed 3.0V, 3.3V, 3.6V and 5.0V Output Voltage
- Operating Temperature Range:
-40°C to +85°C
- Available in SOT-23, SOT-23S, SOT-25 and SOT89-3 packages

APPLICATION

- Audio/Video Equipment
- Communication Equipment
- Battery-Powered Equipment
- Automotive Head Unit
- Laptop, Palmtops, Notebook Computers

TYPICAL APPLICATION

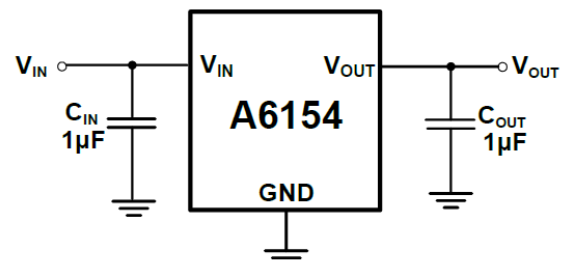



PIN DESCRIPTION

<p style="text-align: center;">Top View</p>			<p style="text-align: center;">Top View</p>			<p style="text-align: center;">Top View</p>			
<p style="text-align: center;">Top View</p>					<p style="text-align: center;">Top View</p>				
Pin #					Symbol	Function			
SOT-23	SOT-23S	SOT-25	SOT89-3						
			A	B					
1	1	2	2	1	GND	Ground			
2	2	5	1	3	V _{OUT}	Regulator Output. Recommended output capacitor range: 1μF to 10μF.			
3	3	1	3	2	V _{IN}	Regulator Input. Up to 36V input voltage. At least 1μF supply bypass capacitor is recommended.			
-	-	3	-	-	EN	Enable pin. Drive EN greater than V _{EN(H)} to turn on the regulator. Drive EN less than V _{EN(L)} to put the LDO into shutdown mode.			
-	-	4	-	-	NC	Not connect			



ABSOLUTE MAXIMUM RATINGS

over operating free-air temperature range, unless otherwise noted^{NOTE1}

V _{IN} , Input Voltage	-0.3V ~ 36V
V _{EN} , Enable Input Voltage	-0.3V ~ V _{IN}
T _J , Junction Temperature	-40°C~150°C
P _D , Continuous Power Dissipation ^{NOTE2}	Internally Limited
T _{STG} , Storage Temperature	-65°C~150°C

Stress beyond above listed "Absolute Maximum Ratings" may lead permanent damage to the device. These are stress ratings only and operations of the device at these or any other conditions beyond those indicated in the operational sections of the specifications are not implied. Exposure to absolute maximum rating conditions for extended periods may affect device reliability.

NOTE1: All voltages are with respect to the GND pin.

NOTE2: Internal thermal shutdown circuitry protects the device from permanent damage.

RECOMMENDED WORK CONDITIONS

over operating free-air temperature range, unless otherwise noted^{NOTE1}

Parameter	Symbol	Min	Max	Unit
Input Supply Voltage	V _{IN}	2.5	36	V
Enable Voltage	V _{EN}	0	36	V
Operating Temperature	T _A	-40	+85	°C

NOTE1: All voltages are with respect to the GND pin.



ELECTRICAL CHARACTERISTICS

$V_{IN} = V_{OUT} + 2V$, $C_{IN} = C_{OUT} = 1\mu F$, $V_{OUT} = 3.3V$, Full = $-40^{\circ}C$ to $+85^{\circ}C$, typical values are at $T_A = +25^{\circ}C$, unless otherwise noted.

Parameter	Symbol	Conditions	Temp	Min.	Typ.	Max.	Unit	
Input Voltage	V_{IN}	$V_{OUT} = 3.3V$	$+25^{\circ}C$	2.5 NOTE1	-	36	V	
Output Voltage Accuracy		$I_{OUT} = 0.1mA$	$+25^{\circ}C$	-2.5	0	2.5	%	
		$I_{OUT} = 1mA$, Class A	$+25^{\circ}C$	-1.0	0	1.0	%	
Ground Pin Current		No load	$+25^{\circ}C$	$V_{IN} = V_{OUT} + 2V$	-	2.5	5	μA
				$V_{IN} = 36V$	-	5.0	8	
		$I_{OUT} = 50mA$	-	2.5	-			
Maximum Output Current ^{NOTE2}			$+25^{\circ}C$	150	-	-	mA	
Dropout Voltage ^{NOTE3}	V_{DROP}	$I_{OUT} = 500mA$	$+25^{\circ}C$	-	1200	1800	mV	
Line Regulation	ΔV_{OUT}	$V_{IN} = V_{OUT} + 2V$ to $36V$, $I_{OUT} = 1mA$	$+25^{\circ}C$	-	0.001	0.012	%/ V	
	$\Delta V_{IN} \times V_{OUT}$							
Load Regulation	ΔV_{OUT}	$V_{IN} = V_{OUT} + 2V$, $I_{OUT} = 1mA$ to $150mA$	$+25^{\circ}C$	-	11	20	mV	
Power Supply Rejection Ratio	PSRR	$V_{OUT} = 3.3V$, $I_{OUT} = 10mA$	$+25^{\circ}C$	$f = 217Hz$	-	57	-	dB
				$f = 1KHz$	-	54	-	
Output Voltage Temperature Coefficient ^{NOTE4}	ΔV_{OUT}	$I_{OUT} = 1mA$	Full	-	70	-	ppm/ $^{\circ}C$	
	$\Delta T_A \times V_{OUT}$							
THERMAL PROTECTION								
Thermal Shutdown Temperature	T_{SHDN}		-	-	120	-	$^{\circ}C$	
SHUTDOWN								
EN Voltage Range	V_{EN}		Full	-0.3	-	$V_{IN} + 0.3$	V	
EN Input Threshold	V_{IH}	$V_{IN} = V_{OUT} + 2V$ to $36V$	Full	1.1	-	-	V	
	V_{IL}	$V_{IN} = V_{OUT} + 2V$ to $36V$	Full	-	-	0.4		
EN Input Bias Current	I_{BH}	EN=36V	$+25^{\circ}C$	-	0.01	1	μA	
	I_{BL}	EN=0V	Full	-	0.01	1		
Shutdown Supply Current	$I_{Q(SHDN)}$	EN=0V	Full	-	1.0	2	μA	
Start-Up Time ^{NOTE5}	t_{STR}	$C_{OUT} = 1\mu F$, No Load	$+25^{\circ}C$	-	230	-	μs	



$V_{IN} = V_{OUT} + 2V$, $C_{IN} = C_{OUT} = 1\mu F$, $V_{OUT} = 5.0V$, Full = $-40^{\circ}C$ to $+85^{\circ}C$, typical values are at $T_A = +25^{\circ}C$, unless otherwise noted.

Parameter	Symbol	Conditions	Temp	Min.	Typ.	Max.	Unit	
Input Voltage	V_{IN}		$+25^{\circ}C$	2.5 NOTE1	-	36	V	
Output Voltage Accuracy		$I_{OUT} = 0.1mA$	$+25^{\circ}C$	-2.5	0	2.5	%	
		$I_{OUT} = 1mA$, Class A	$+25^{\circ}C$	-1.0	0	1.0	%	
Ground Pin Current		No load	$V_{IN} = V_{OUT} + 2V$ $V_{IN} = 36V$	$+25^{\circ}C$	-	2.5	5	μA
					-	5.0	8	
		$I_{OUT} = 50mA$		-	2.5	-		
Maximum Output Current ^{NOTE2}			$+25^{\circ}C$	150	-	-	mA	
Dropout Voltage ^{NOTE3}	V_{DROP}	$I_{OUT} = 150mA$	$+25^{\circ}C$	-	1000	1600	mV	
Line Regulation	ΔV_{OUT}	$V_{IN} = V_{OUT} + 2V$ to 36V, $I_{OUT} = 1mA$	$+25^{\circ}C$	-	0.001	0.012	% / V	
	$\Delta V_{IN} \times V_{OUT}$							
Load Regulation	ΔV_{OUT}	$V_{IN} = V_{OUT} + 2V$, $I_{OUT} = 1mA$ to 150mA	$+25^{\circ}C$	-	11	20	mV	
Power Supply Rejection Ratio	PSRR	$V_{OUT} = 5.0V$, $I_{OUT} = 10mA$	$+25^{\circ}C$	$f = 217Hz$	-	57	-	dB
				$f = 1KHz$	-	54	-	
Output Voltage Temperature Coefficient ^{NOTE4}	ΔV_{OUT}	$I_{OUT} = 1mA$	Full	-	70	-	ppm/ $^{\circ}C$	
	$\Delta T_A \times V_{OUT}$							
THERMAL PROTECTION								
Thermal Shutdown Temperature	T_{SHDN}		-	-	120	-	$^{\circ}C$	
SHUTDOWN								
EN Voltage Range	V_{EN}		Full	-0.3	-	$V_{IN} + 0.3$	V	
EN Input Threshold	V_{IH}	$V_{IN} = V_{OUT} + 2V$ to 36V	Full	1.1	-	-	V	
	V_{IL}	$V_{IN} = V_{OUT} + 2V$ to 36V	Full	-	-	0.4		
EN Input Bias Current	I_{BH}	EN=36V	$+25^{\circ}C$	-	0.01	1	μA	
	I_{BL}	EN=0V	Full	-	0.01	1		
Shutdown Supply Current	$I_{Q(SHDN)}$	EN=0V	Full	-	1.0	2	μA	
Start-Up Time ^{NOTE5}	t_{STR}	$C_{OUT} = 1\mu F$, No Load	$+25^{\circ}C$	-	230	-	μs	

NOTE1: $V_{IN} = V_{OUT(NOMINAL)}$ or 2.5V, whichever is greater.

NOTE2: Maximum output current is affected by the PCB layout, size of metal trace, the thermal conduction path between metal layers, ambient temperature and the other environment factors of system. Attention should be paid to the dropout voltage when $V_{IN} < V_{OUT} + V_{DROP}$.

NOTE3: The dropout voltage is defined as $V_{IN} - V_{OUT}$, when V_{OUT} is 100mV below the value of V_{OUT} for $V_{IN} = V_{OUT(NOMINAL)} + 2V$.

NOTE4: Output voltage temperature coefficient is defined as the worst-case voltage change divided by the total temperature range.

NOTE5: Time needed for V_{OUT} to reach 90% of final value.



TYPICAL PERFORMANCE CHARACTERISTICS

$V_{IN} = 5.3V$, $V_{OUT} = 3.3V$, $C_{IN} = C_{OUT} = 1\mu F$, $T_A = 25^\circ C$, unless otherwise noted.

1. Line-Transient Response

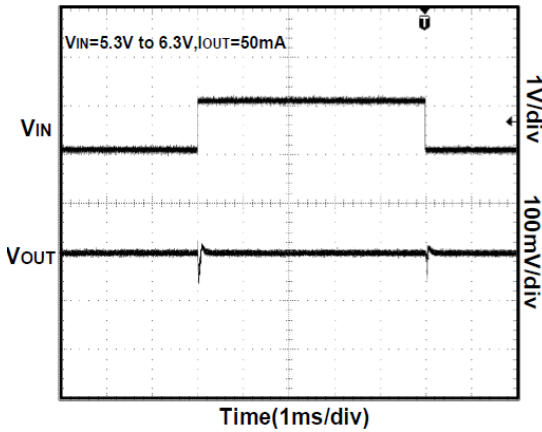

2. Load-Transient Response

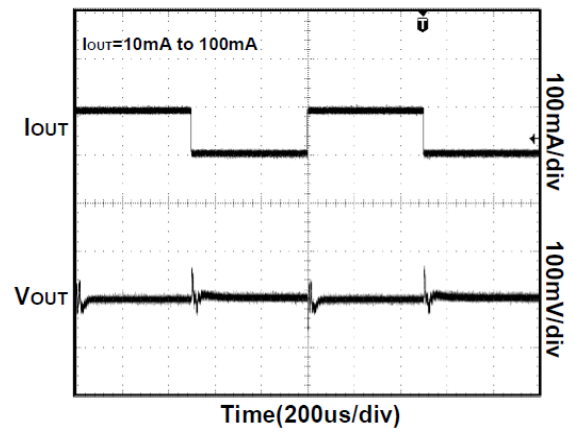

3. Power-Up/Power-Down Output Waveform

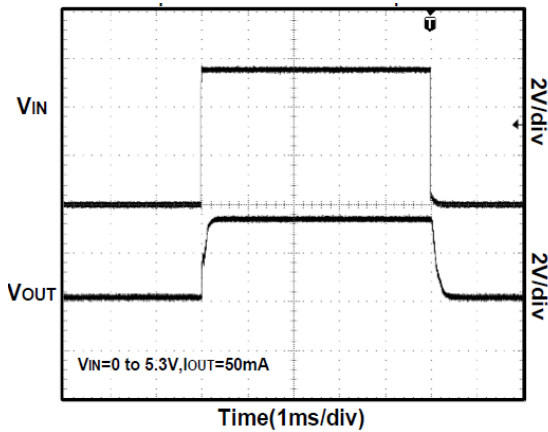

4. Output Short Waveform

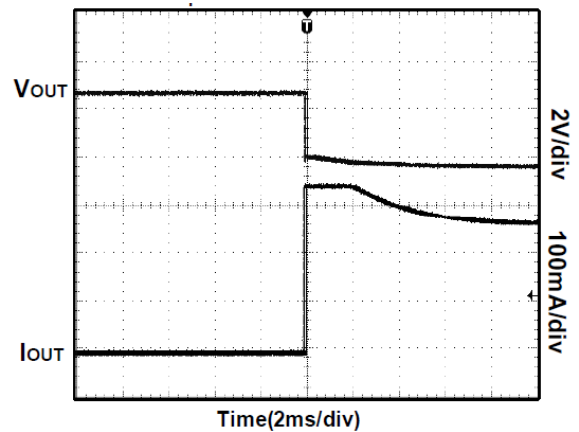

5. Dropout Voltage vs. Temperature

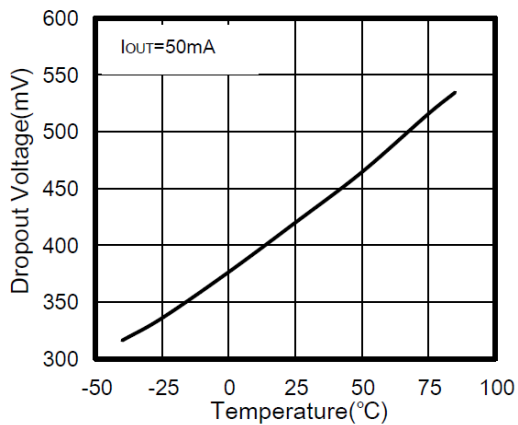

6. Dropout Voltage vs. Output Current

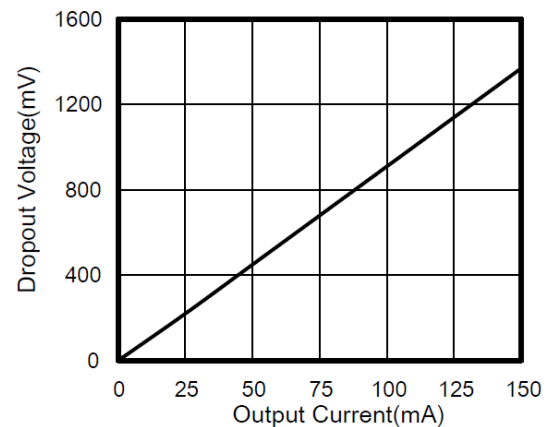



7. Ground Pin Current vs Input Voltage

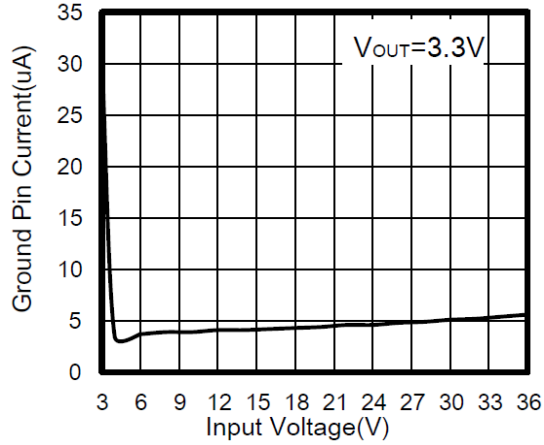

8. Ground Pin Current vs Load Current

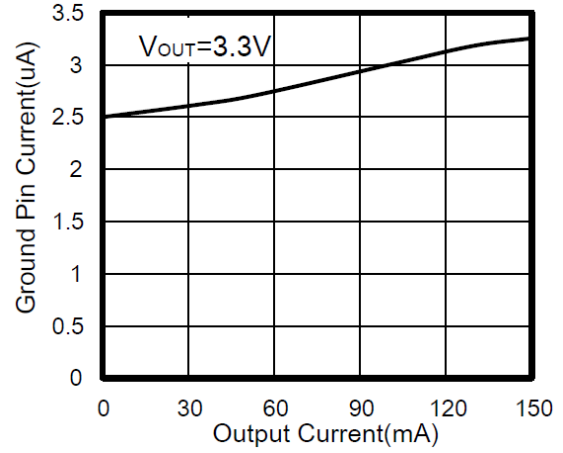

9. Line Regulation

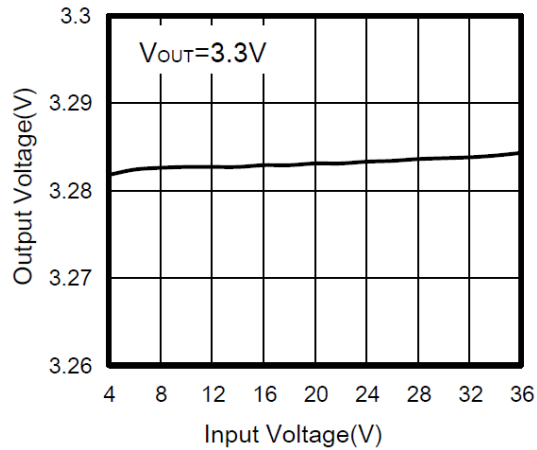

10. Load Regulation ($V_{OUT}=3.3V$)

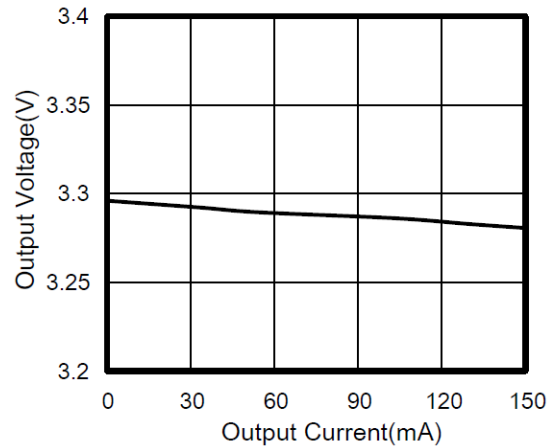



BLOCK DIAGRAM

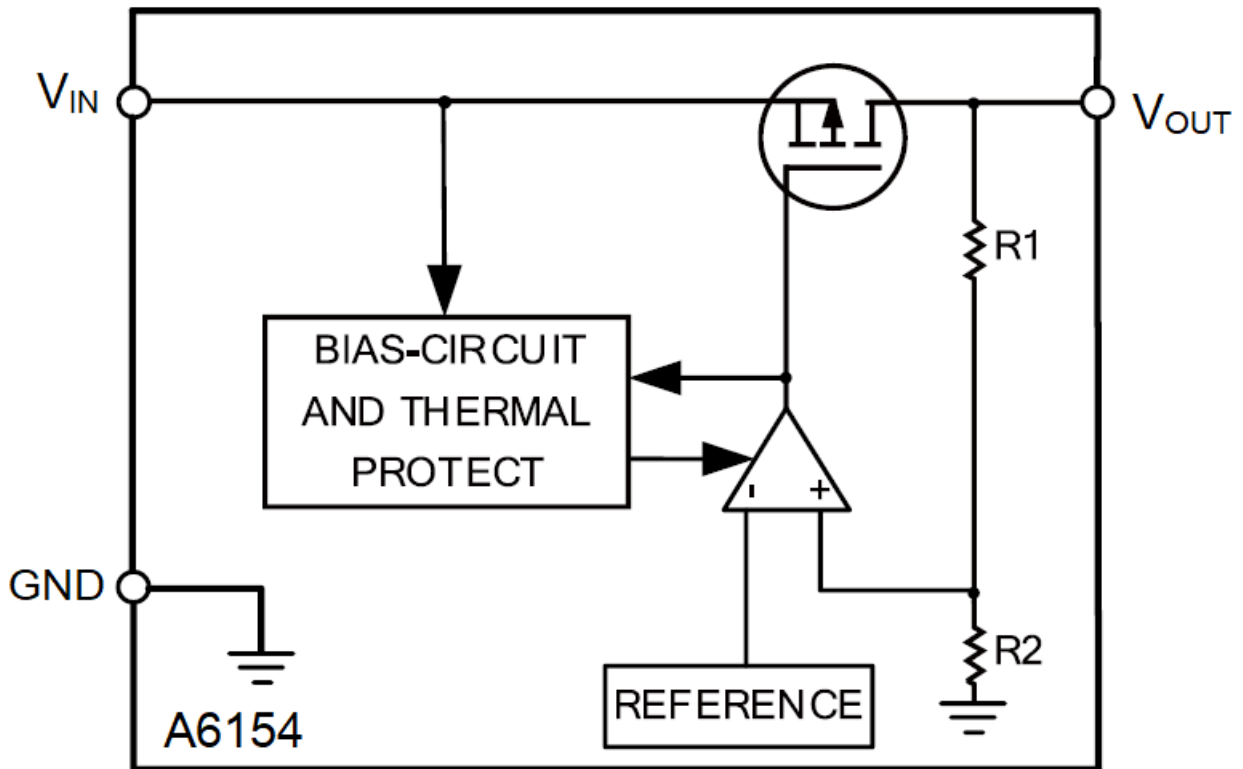



DETAILED INFORMATION

Overview

The A6154 low-dropout regulators (LDO) consumes only 2.5 μ A of quiescent current at light load and delivers excellent line and load transient performance. These characteristics, combined with low noise and good PSRR with low dropout voltage, make this device ideal for portable consumer applications.

Thermal Considerations

When the junction temperature is too high, the thermal protection circuitry sends a signal to the control logic that will shut down the IC. The IC will restart when the temperature has sufficiently cooled down. The maximum power dissipation is dependent on the thermal resistance of the case and the circuit board, the temperature difference between the die junction and the ambient air, and the rate of air flow. The GND pin must be connected to the ground plane for proper dissipation.

Operation with V_{IN} Lower Than 2.5V

The device normally operates with input voltages above 2.5V. At input voltages below the 2.5V, the device does not operate.

Operation with V_{IN} Larger Than 2.5V

When V_{IN} is greater than 2.5V, if V_{IN} is also higher than the output set value plus the device dropout voltage, V_{OUT} is equal to the set value. Otherwise, V_{OUT} is equal to V_{IN} minus the dropout voltage.



PACKAGE INFORMATION

Dimension in SOT-23 (Unit: mm)

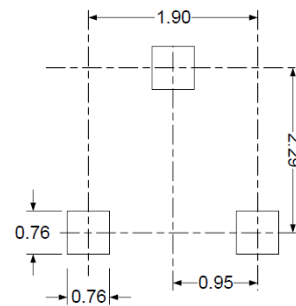
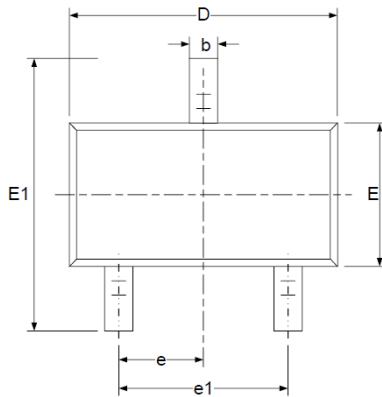

RECOMMENDED LAND PATTERN (Unit: mm)

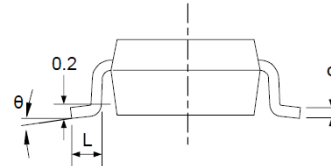
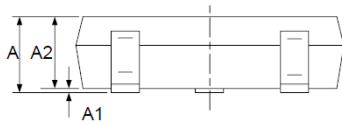

Symbol	Millimeters		Inches	
	Min	Max	Min	Max
A	0.900	1.150	0.035	0.045
A1	0.000	0.100	0.000	0.004
A2	0.900	1.050	0.035	0.041
b	0.300	0.500	0.012	0.020
c	0.080	0.150	0.003	0.006
D	2.800	3.000	0.110	0.118
E	1.200	1.400	0.047	0.055
E1	2.250	2.550	0.089	0.100
e	0.950 BSC		0.03 BSC	
e1	1.800	2.000	0.071	0.079
L	0.300	0.500	0.012	0.020
θ	0°	8°	0°	8°



Dimension in SOT-23S (Unit: mm)

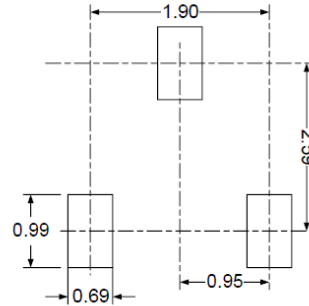
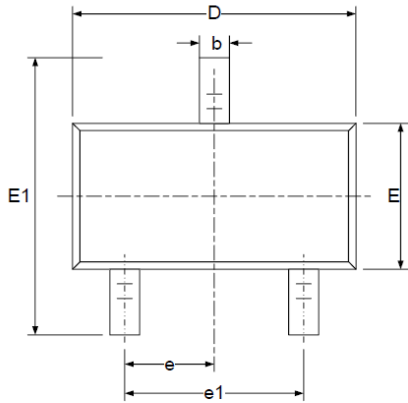

RECOMMENDED LAND PATTERN (Unit: mm)

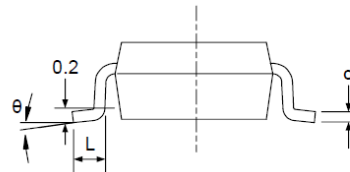
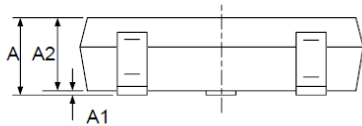

Symbol	Millimeters		Inches	
	Min	Max	Min	Max
A	1.050	1.250	0.041	0.049
A1	0.000	0.100	0.000	0.004
A2	1.050	1.150	0.041	0.045
b	0.300	0.500	0.012	0.020
c	0.100	0.200	0.004	0.008
D	2.820	3.020	0.111	0.119
E	1.500	1.700	0.059	0.067
E1	2.650	2.950	0.104	0.116
e	0.950 BSC		0.037 BSC	
e1	1.800	2.000	0.071	0.079
L	0.300	0.600	0.012	0.024
θ	0°	8°	0°	8°



Dimension in SOT-25 (Unit: mm)

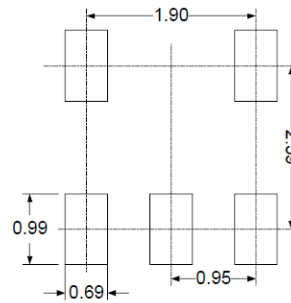
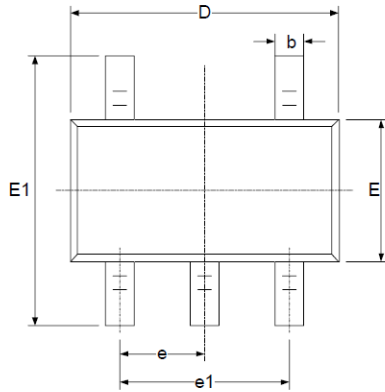

RECOMMENDED LAND PATTERN (Unit: mm)

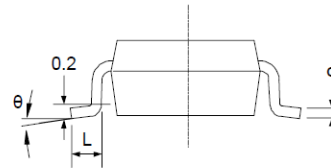
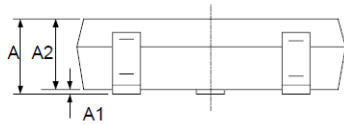

Symbol	Millimeters		Inches	
	Min	Max	Min	Max
A	1.050	1.250	0.041	0.049
A1	0.000	0.100	0.000	0.004
A2	1.050	1.150	0.041	0.045
b	0.300	0.500	0.012	0.020
c	0.100	0.200	0.004	0.008
D	2.820	3.020	0.111	0.119
E	1.500	1.700	0.059	0.067
E1	2.650	2.950	0.104	0.116
e	0.950 BSC		0.037 BSC	
e1	1.800	2.000	0.071	0.079
L	0.300	0.600	0.012	0.024
θ	0°	8°	0°	8°



Dimension in SOT89-3 (Unit: mm)

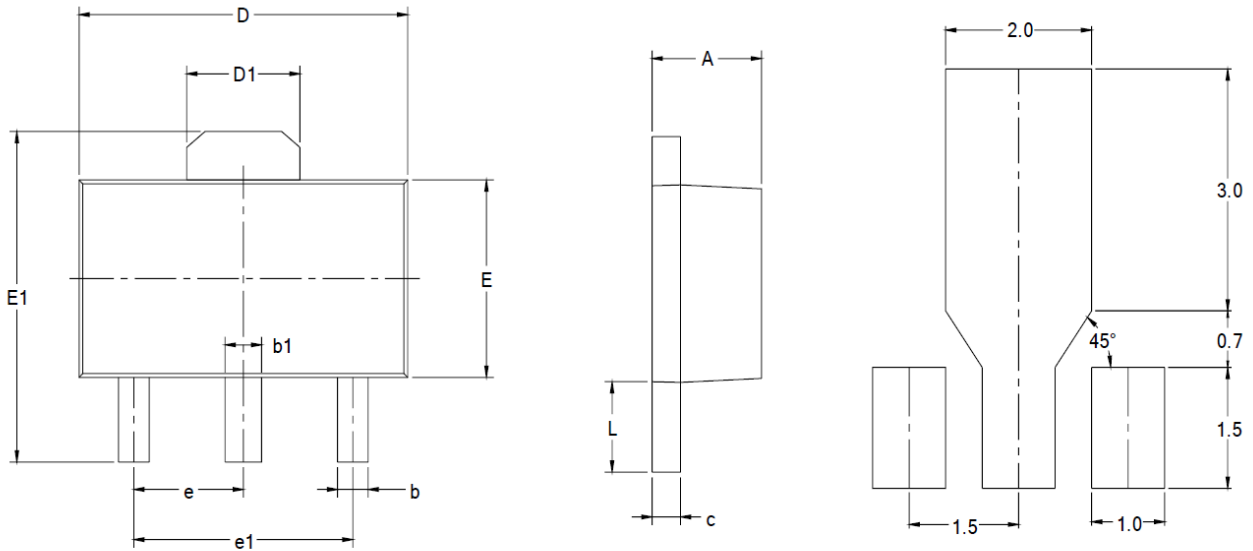

RECOMMENDED LAND PATTERN (Unit: mm)

Symbol	Millimeters		Inches	
	Min	Max	Min	Max
A	1.400	1.600	0.055	0.063
b	0.320	0.520	0.013	0.020
b1	0.400	0.580	0.016	0.023
c	0.350	0.440	0.014	0.017
D	4.400	4.600	0.173	0.181
D1	1.550 REF		0.061 REF	
E	2.300	2.600	0.091	0.102
E1	3.940	4.250	0.155	0.167
e	1.500 BSC		0.060 BSC	
e1	3.000 BSC		0.118 BSC	
L	0.900	1.200	0.035	0.047



IMPORTANT NOTICE

AiT Semiconductor Inc. (AiT) reserves the right to make changes to any its product, specifications, to discontinue any integrated circuit product or service without notice, and advises its customers to obtain the latest version of relevant information to verify, before placing orders, that the information being relied on is current.

AiT Semiconductor Inc.'s integrated circuit products are not designed, intended, authorized, or warranted to be suitable for use in life support applications, devices or systems or other critical applications. Use of AiT products in such applications is understood to be fully at the risk of the customer. As used herein may involve potential risks of death, personal injury, or severe property, or environmental damage. In order to minimize risks associated with the customer's applications, the customer should provide adequate design and operating safeguards.

AiT Semiconductor Inc. assumes to no liability to customer product design or application support. AiT warrants the performance of its products of the specifications applicable at the time of sale.