

COOPER

Bussmann®

Productivity Through Protection™

Circuit Protection Solutions

Low Voltage Fuse Links Catalogue



COOPER Bussmann

Table of Contents

| | |
|---|---------|
| Domestic Applications to BS1361 & BS1312 | |
| Consumer Unit Fuse Link | 4 |
| Plug Top Fuse Links | 4 |
| Industrial & Motor Applications to BS88 | |
| Offset Bolted Tags | 5 - 7 |
| Centre Bolted Tags | 8 - 9 |
| Offset Blade Tags | 10 |
| Merchandising Stand | 11 |
| Industrial Applications to BS88 - 500Vdc | |
| Special DC Range Offset/Centre Bolted Tag | 12 |
| Industrial Applications to BS88 - 660/690V | |
| Offset Bolted Tags | 13 |
| Centre Bolted Tags | 14 |
| Special Tag Arrangements | 15 |
| Street Lighting Applications to BS88 | |
| Offset Bolted Tags | 16 |
| Utility Applications to BS88 | |
| House-Service Cut-Out Fuse Links | 17 |
| J Type Fuse Links to BS88: Part 5 Cylindrical | 17 |
| J Type Fuse Links to BS88: Part 5 Slotted/Non Slotted | 18 |
| Joint NATO Reference System | |
| Cylindrical/Offset Bolted Tag | 19 |
| BS88 Fuseholders | |
| Camaster HRC Fuseholder | 20 |
| Safeloc Fuseholder | 21 |
| Cylindrical Domestic Fuses | 22 |
| Domestic Fuses | 23 |
| Cylindrical Industrial Fuses | |
| Class gG | 24 |
| Class aM | 25 |
| CHD | 26 |
| CHM | 27 |
| CH | 28 |
| NH Fuses - Dual Indicator | |
| Class gG - Low Power Loss | 29 - 30 |
| Class gG | 31 |
| Class aM | 32 - 33 |
| Class gG - aM | 34 |
| NH Fuses - Dimensions | 35 |
| NH Fuseholders for Knife Fuses | 36 |
| Dimensions for Knife fuse and Fuseholders (NH) | 37 - 38 |
| NH Fuse Rails and Disconnectors | 39 - 41 |
| DO Fuses | 42 |
| DO Fuseholders | 43 |
| D Fuses | 44 |
| D Fuseholders | 45 |
| Other Low Voltage Fuse Ranges | 46 |
| Medium Voltage Fuses and Isolators | 47 |
| Ultra Fast Fuses and Holders | 48 - 49 |



Domestic Applications to BS1361 & BS1312

**Consumer Unit Fuse Link
240V / 5 - 45 A**



Specifications

Description: Cylindrical Fuse Links for domestic application according to BS1361

Ratings:

Volts: - 240V
Amps: - 5 - 45A
IR - 16.5kA

Applications: Protection of domestic distribution systems.

Agency Information: Approved to BS1361

Catalogue Numbers

| Rating (A) | Catalogue Number | Colour Code | Unit Packing |
|------------|------------------|-------------|--------------|
| 5 | C55 | White | 10 |
| 15 | C1515 | Blue | |
| 20 | C1520 | Yellow | |
| 30 | C3030 | Red | |
| 45 | C4545 | Green | |

BK (Part Number), Unit packing = 100

Dimensions

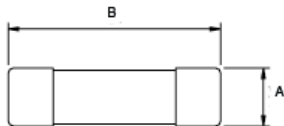

| Catalogue Number | A | B |
|------------------|-------|----|
| C55 | 5.35 | 23 |
| C1515 | 10.2 | 26 |
| C1520 | 10.32 | 26 |
| C3030 | 12.7 | 29 |
| C4545 | 16.67 | 35 |

**Plug Top Fuse Links
240V / 1 - 13A**



Specifications

Description: Cylindrical Fuse links for domestic applications according to BS1362, to be fitted into domestic BS1363 plug top to conform with the requirements of the Plug and Socket Safety Regulations 1995

Ratings:

Volts: - 240V
Amps: - 1 - 13A
IR - 6kA

Applications: protection of the cables connected to domestic equipment against overloads or small overcurrents.

Agency Information: BSI Kite Mark, ASTA accreditation (except 1A Fuse), BS1362

RoHS Compliant

Catalogue Numbers

| Rating (A) | Catalogue Number | Colour Code | Unit Packing |
|------------|------------------|-------------|--------------|
| 1 | C180-1A | Black | 10 |
| 2 | C180-2A | Black | |
| 3 | C180-3A | Red | |
| 5 | C180-5A | Black | |
| 7 | C180-7A | Black | |
| 10 | C180-10A | Black | |
| 13 | C180-13A | Black | |

BK-(Part Number), Unit packing= 100

Dimensions

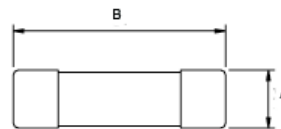

| Catalogue Number | A | B |
|------------------|------|------|
| C180-RatingA | 6.45 | 25.4 |

Industrial & Motor Applications to BS88

Offset Bolted Tags 240 - 550V ac / 2 - 32A

Specifications

Description: Fuse Links for general industrial applications with Q1 fusing factor - general purpose (gG) and motor protection (gM) characteristics

Applications: General Industrial & Motors applications

Ratings:

Volts: - 415 - 550V ac
Amps: - 2 - 32A
IR - 80kA @ 415/550V ac

Agency information: Meets BS88: Part 1 & 2 (1988), IEC 269: Parts 1 (1986)

RoHS Compliant

NITD 550V ac (gG) / 2 - 32A 415V ac (gM)



Catalogue Numbers

| Rating (A) | Catalogue Number | Class | BS Ref | Fixing Centres mm | Unit Packing |
|------------|------------------|-------|--------|-------------------|--------------|
| 2 | NITD2 | gG | A1 | 44 | 20 |
| 4 | NITD4 | | | | |
| 6 | NITD6 | | | | |
| 10 | NITD10 | | | | |
| 16 | NITD16 | | | | |
| 20 | NITD20 | | | | |
| 25 | NITD25 | | | | |
| 32 | NITD32 | | | | |
| 20M25 | NITD20M25 | | | | |
| 20M32 | NITD20M32 | | | | |
| 32M40 | NITD32M40 | gM | | | |
| 32M50 | NITD32M50 | | | | |
| 32M63 | NITD32M63 | | | | |
| | | | | | |

Fuseholders: CAMASTER CM32FC, see page 20

Dimensions

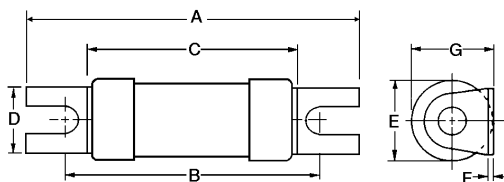

| Part No | Dimensions (mm) | | | | | | |
|---------|-----------------|----|------|------|------|-----|------|
| | A | B | C | D | E | F | G |
| NITD | 55.0 | 44 | 34.6 | 11.2 | 13.8 | 0.8 | 14.0 |
| NITD32M | | | 35.6 | | 17.5 | 1.2 | 18.5 |

Data Sheet: 4106

AAO 550V ac / 2 - 32A



Catalogue Numbers

| Rating (A) | Catalogue Number | Class | BS Ref | Fixing Centres mm | Unit Packing | | | | |
|------------|------------------|-------|--------|-------------------|--------------|----|--|--|--|
| 2 | AAO2 | gG | A2 | 73 | 20 | | | | |
| 4 | AAO4 | | | | | | | | |
| 6 | AAO6 | | | | | | | | |
| 10 | AAO10 | | | | | | | | |
| 16 | AAO16 | | | | | | | | |
| 20 | AAO20 | | | | | | | | |
| 25 | AAO25 | | | | | | | | |
| 32 | AAO32 | | | | | | | | |
| 32M40 | AAO32M40 | | | | | gM | | | |
| 32M50 | AAO32M50 | | | | | | | | |
| 32M63 | AAO32M63 | | | | | | | | |

Fuseholders: CAMASTER CM32F, see page 20

Dimensions

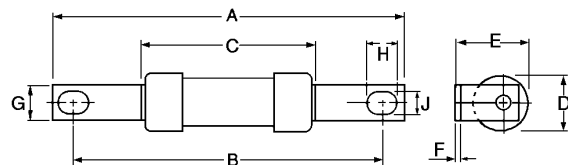

| Part No | Dimensions (mm) | | | | | | | | |
|---------|-----------------|----|------|------|------|-----|-----|-----|-----|
| | A | B | C | D | E | F | G | H | J |
| AAO | 85 | 73 | 35.5 | 13.7 | 14 | 1.2 | 8.7 | 8.0 | 5.5 |
| AAO32M | | | 54.5 | 21 | 22.3 | | | | |

Data Sheet: 4109

Industrial & Motor Applications to BS88

Offset Bolted Tags (Cont.../...)
240-550V / 32 - 100A

Specifications

Description: Fuse Links for general industrial applications with Q1 fusing factor - general purpose (gG) and motor protection (gM) characteristics

Applications: General Industrial & Motors applications

Ratings:

Volts: - 415 - 550V ac
 Amps: - 32 - 100A
 IR - 80kA @ 415 / 550V ac

Agency information: Meets BS88: Part 1 & 2 (1988), IEC 269: Parts 1 (1986) and CSA C22.2 No 106-M 1985

RoHS Compliant

BAO
550V ac / 35-63A



Catalogue Numbers

| Rating (A) | Catalogue Number | Class | BS Ref | Fixing Centres mm | Unit Packing |
|------------|------------------|-------|--------|-------------------|--------------|
| 35 | BAO35 | gG | A3 | 73 | 20 |
| 40 | BAO40 | | | | |
| 50 | BAO50 | | | | |
| 63 | BAO63 | | | | |
| 63M80 | BAO63M80 | gM | | | |
| 63M100 | BAO63M100 | | | | |

Fuseholder: CAMASTER CM63F, see page 20

Dimensions

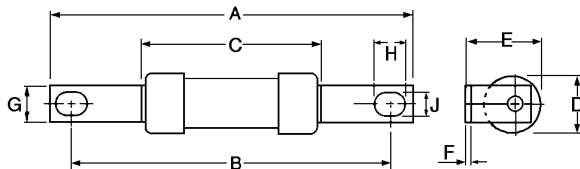

| Part No | Dimensions (mm) | | | | | | | | |
|---------|-----------------|----|------|----|------|-----|------|-----|-----|
| | A | B | C | D | E | F | G | H | J |
| BAO | 87 | 73 | 54.5 | 21 | 22.5 | 1.2 | 12.7 | 8.0 | 5.5 |
| BAO63M | | | | | | | | | |

Data Sheet: 4112

CEO
550V ac / 32-100A
415V ac (gM)



Catalogue Numbers

| Rating (A) | Catalogue Number | Class | BS Ref | Fixing Centres mm | Unit Packing |
|------------|------------------|-------|--------|-------------------|--------------|
| 32 | CEO32 | gG | A4 | 94 | 10 |
| 40 | CEO40 | | | | |
| 50 | CEO50 | | | | |
| 63 | CEO63 | | | | |
| 80 | CEO80 | | | | |
| 100 | CEO100 | | | | |
| 100M125 | CEO100M125 | gM | | | |
| 100M160 | CEO100M160 | | | | |
| 100M200 | CEO100M200 | | | | |

Dimensions

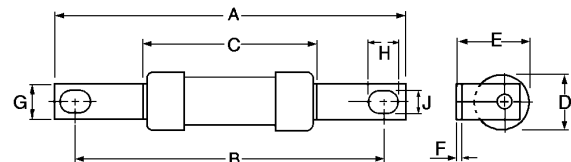

| Part No | Dimensions (mm) | | | | | | | | |
|------------------|-----------------|----|------|------|------|------|------|------|-----|
| | A | B | C | D | E | F | G | H | J |
| CEO | 110 | 94 | 58.5 | 21.0 | 24.5 | 3.2 | 14.3 | 11.0 | 8.7 |
| CEO100M125 & 160 | | | | 25.8 | 26.8 | | | | |
| CEO100M200 | | | 47.0 | 31 | 29.5 | 19.0 | 10.0 | 9.0 | |

Data Sheet: 4115

Industrial & Motor Applications to BS88

Offset Bolted Tags (Cont.../...)
240 - 550V ac / 80 - 200A

Specifications

Description: Fuse Links for general industrial applications with Q1 fusing factor - general purpose (gG) and motor protection (gM) characteristics

Applications: General Industrial & Motors applications

Ratings:

Volts: - 415 - 550V ac
 Amps: - 80 - 200A
 IR - 80kA @ 415 / 550V ac

Agency information: Meets BS88: Part 1 & 2 (1988), IEC 269: Parts 1 (1986)

RoHS Compliant

OSD
550V ac (gG) / 80 - 100A
415V ac (gM)



Catalogue Numbers

| Rating (A) | Catalogue Number | Class | BS Ref | Fixing Centres mm | Unit Packing |
|------------|------------------|-------|--------|-------------------|--------------|
| 80 | OSD80 | gG | N/A | 73 | 20 |
| 100 | OSD100 | | | | |
| 100M125 | OSD100M125 | gM | N/A | 73 | 20 |
| 100M160 | OSD100M160 | | | | |

Fuseholders: CAMASTER CM100F, see page 20

Dimensions

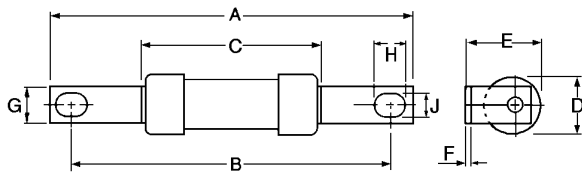

| Part No | Dimensions (mm) | | | | | | | | |
|---------|-----------------|----|------|------|------|-----|------|-----|-----|
| | A | B | C | D | E | F | G | H | J |
| OSD | 95.0 | 73 | 54.5 | 21.0 | 22.5 | 1.2 | 12.7 | 8.0 | 5.5 |
| OSD100M | | | | 26.0 | 25.7 | | | | |

DEO
415V ac / 125 - 200A (gG) (gM)



Catalogue Numbers

| Rating (A) | Catalogue Number | Class | BS Ref | Fixing Centres mm | Unit Packing |
|------------|------------------|-------|--------|-------------------|--------------|
| 125 | DEO125 | gG | N/A | 94 | 5 |
| 160 | DEO160 | | | | |
| 200 | DEO200 | | | | |
| 200M250 | DEO200M250 | gM | N/A | 94 | 5 |
| 200M315 | DEO200M315 | | | | |

Dimensions

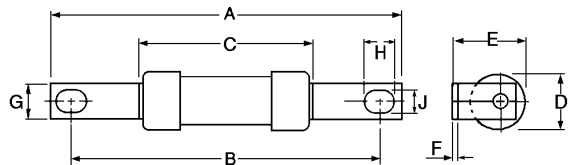

| Part No | Dimensions (mm) | | | | | | | | |
|---------|-----------------|----|------|------|------|-----|------|------|-----|
| | A | B | C | D | E | F | G | H | J |
| DEO | 110 | 94 | 47.0 | 31.0 | 29.5 | 3.2 | 19.0 | 10.0 | 9.0 |
| DEO200M | | | | | | | | | |

Industrial & Motor Applications to BS88

Centre Bolted Tags
415 - 550V ac / 2 - 1250A
250V dc

Specifications

Description: Fuse Links for general industrial applications with Q1 fusing factor - general purpose (gG) and motor protection (gM) characteristics

Applications: General Industrial & Motors applications

Ratings:

- Volts: - 415 - 550V ac / 250V dc
- Amps: - 2 - 1250A
- IR - 40kA @ 250V dc
- 80kA @ 415 / 550V ac

Agency information: Meets BS88: Part 1 & 2 (1988), IEC 269: Parts 1 (1986)

RoHS Compliant

AC / BC
550V ac / 2 - 63A
250 V dc (except gM)



Catalogue Numbers

| Type | Rating (A) | Catalogue Number | Class | Fixing Centres mm | Unit Packing |
|------|------------|------------------|-------|-------------------|--------------|
| AC | 2 | AC2 | gG | 97.5 | 20 |
| | 4 | AC4 | | | |
| | 6 | AC6 | | | |
| | 10 | AC10 | | | |
| | 16 | AC16 | | | |
| | 20 | AC20 | | | |
| | 25 | AC25 | | | |
| BC | 32 | AC32 | gG | 97.5 | 20 |
| | 40 | BC40 | | | |
| | 50 | BC50 | | | |
| | 63 | BC63 | | | |
| | 63M80 | BC63M80 | | | |
| | 63M100 | BC63M100 | gM | | |

Dimensions

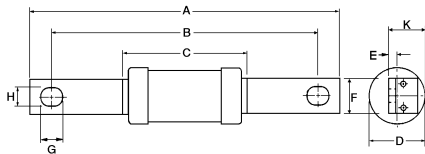

AD / BD / CD / DD / ED
550V ac / 2 - 400A
415V ac (Types gM, DD, ED)
250 V dc (Types AD, BD)



Catalogue Numbers

| Type | Rating (A) | Catalogue Number | Class | Ref BS | Fixing Centres mm | Unit Packing |
|------|------------|------------------|-------|--------|-------------------|--------------|
| AD | 2 | AD2 | gG | N/A | 111 | 20 |
| | 4 | AD4 | | | | |
| | 6 | AD6 | | | | |
| | 10 | AD10 | | | | |
| | 16 | AD16 | | | | |
| | 20 | AD20 | | | | |
| | 25 | AD25 | | | | |
| BD | 32 | AD32 | gG | N/A | 111 | 20 |
| | 40 | BD40 | | | | |
| | 50 | BD50 | | | | |
| CD | 63 | BD63 | gG | B1 | 111 | 10 |
| | 80 | CD80 | | | | |
| | 100 | CD100 | | | | |
| | 100M125 | CD100M125 | | | | |
| | 100M160 | CD100M160 | | | | |
| DD | 100M200 | CD100M200 | gM | B2 | 111 | 5 |
| | 125 | DD125 | | | | |
| | 160 | DD160 | | | | |
| | 200 | DD200 | | | | |
| ED | 200M250 | DD200M250 | gG | B3/B4 | 111 | 1 |
| | 200M315 | DD200M315 | | | | |
| | 250 | ED250 | | | | |
| | 315 | ED315 | | | | |
| | 355 | ED355 | | | | |
| ED | 400 | ED400 | gM | B3/B4 | 111 | 1 |
| | 315M400 | ED315M400 | | | | |
| | 400M500 | ED400M500* | | | | |
| | | | | | | |

*-550V ac

| Part No | Dimensions | | | | | | | | |
|-----------------------|------------|------|------|------|-----|------|------|------|------|
| | A | B | C | D | E | F | G | H | K |
| AC | 113.5 | 97.5 | 55.5 | 21.0 | 1.6 | 12.7 | 13.5 | 7.0 | 11.2 |
| AD | 128.5 | 111 | 55.0 | 21.0 | 1.4 | 14.2 | 11.8 | 8.7 | 11.2 |
| BC | 113.5 | 97.5 | 55.0 | 21.0 | 1.6 | 7.0 | 13.5 | 12.7 | 11.2 |
| BC63M | | | | | | | | | |
| BD | 128.5 | 111 | 55.0 | 21.0 | 1.4 | 14.2 | 11.8 | 8.7 | 11.2 |
| CD | 126 | 111 | 58.5 | 21.0 | 3.2 | 14.3 | 11.1 | 8.7 | 19.5 |
| CD100M125 & CD100M160 | | | | 26.0 | | | | | 22.0 |
| CD100M200 | | | | 31.0 | | | | | 2.5 |
| DD | 136 | 111 | 47.0 | 31.0 | 3.2 | 19.0 | 12.5 | 9.0 | 22.5 |
| DD200M | | | | | | | | | |
| ED250 | 136 | 111 | 47.0 | 31.0 | 4.7 | 19.0 | 12.5 | 9.0 | 22.5 |
| ED315 | | | 50.0 | 38.0 | | | | | 31.0 |
| ED315M400.0 | | | 75.0 | 59.0 | | | | | |
| ED400M500 | | | | | | | | | |

Data Sheets: AC: 4110 / BC: 4113 / AD: 4111 / BD: 4114 / CD: 4116 / DD: 4118 / ED: 4119

Industrial & Motor Applications to BS88

Centre Bolted Tags (Cont.../...)

415 - 550Vac / 125 - 1250A
250 - 400Vdc

Specifications

Description: Fuse Links for general industrial applications with Q1 fusing factor - general purpose (gG) and motor protection (gM) characteristics

Applications: General Industrial & Motors applications

Ratings:

- Volts: - 415 - 550V ac / 250V dc
- Amps: - 2 - 1250A
- IR - 40kA @ 250V dc GF, GG except 1000 & 1250A
- 40kA @ 400V dc FG, FF
- 80kA @ 415/550V ac

Agency information: Meets BS88: Part 1 & 2 (1988), IEC 269: Parts 1 (1986)

RoHS Compliant

EFS / EF / FF / GF
415V ac / 125 - 800A
550V ac (Types EF - gM, FF, FG, GF)
250V dc (Type GF)



Catalogue Numbers

| Type | Rating (A) | Catalogue Number | Class | Ref BS | Fixing Centres mm | Unit Packing | Interrupting Rating |
|------|------------|------------------|-------|--------|-------------------|--------------|---------------------------------|
| EFS | 125 | EFS125 | gG | N/A | 133 | 1 | 80kA @ 415 Vac |
| | 160 | EFS160 | | | | | |
| | 200 | EFS200 | | | | | |
| | 250 | EFS250 | | | | | |
| | 315 | EFS315 | | | | | |
| EF | 355 | EF355 | gG | C1 | 133/184 | 1 | 80kA @ 415 Vac |
| | 400 | EF400 | | | | | |
| | 400M500 | EF400M500 | gM | | | | |
| FF | 450 | FF400 | gG | C2 | 133/184 | 1 | 80kA @ 415 Vac 40kA @ 400Vdc |
| | 500 | FF500 | | | | | |
| | 560 | FF560 | | | | | |
| | 630 | FF630 | | | | | |
| GF | 710 | GF710 | gG | C3 | 133/184 | 1 | 80kA @ 550Vac 40kA @ 250Vdc |
| | 800 | GF800 | | | | | |
| | 1000 | GF1000 | | | | | |
| | 1250 | GF1250 | | | | | |

Dimensions

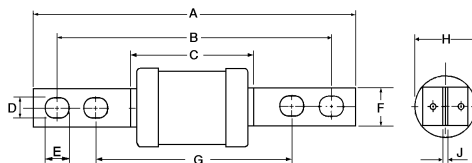

| Part No | Dimensions (mm) | | | | | | | | |
|-------------|-----------------|-----|------|------|------|------|-----|------|-----|
| | A | B | C | D | E | F | G | H | J |
| EFS315 | 209 | 184 | 50.0 | 10.5 | 12.5 | 25.4 | 133 | 38.0 | 4.7 |
| EF355 & 400 | | | | | | | | | |
| EF400M500 | 210 | 184 | 75.0 | | 15.5 | | | 59.0 | |
| FF | 210 | 184 | 77.5 | 10.5 | 15.5 | 25.4 | 133 | 74.0 | 6.4 |
| FG | 262 | 231 | 77.5 | 10.5 | 15.5 | 38.0 | 167 | 74 | 6.4 |
| GF | 210 | 184 | 80.5 | 10.5 | 15.5 | 25.4 | 133 | 83.0 | 9.5 |

Data Sheets: EFS: 4121 / EF: 4120 / FF: 4102 / GF: 4103

FG / GG / GH
550V ac / 450 - 1250A
250V dc (Type GG 710-800A only)
400V dc (Type FG)



Catalogue Numbers

| Type | Rating (A) | Catalogue Number | Class | Fixing Centres mm | Unit Packing | Interrupting Rating |
|------|------------|------------------|-------|-------------------|--------------|--------------------------------|
| FG | 450 | FG450 | gG | 167/231 | 1 | 80kA @ 550Vac 40kA @ 400Vdc |
| | 500 | FG500 | | | | |
| | 560 | FG560 | | | | |
| | 630 | FG630 | | | | |
| GG | 710 | GG710 | gG | 165/231 | 1 | 80kA @ 550Vdc 40kA @ 250Vdc |
| | 800 | GG800 | | 165/228.5 | | 80kA @ 550Vdc No DC Rating |
| | 1000 | GG1000 | | | | |
| | 1250 | GG1250 | | | | |
| GH | 710 | GH710 | gG | 149 | 1 | 80kA @ 550Vac |
| | 800 | GH800 | | | | |
| | 1000 | GH1000 | | | | |
| | 1250 | GH1250 | | | | |

Dimensions

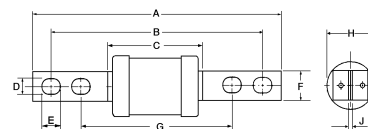

| Part No | Dimensions (mm) | | | | | | | | |
|---------------|-----------------|-------|------|------|------|------|-----|------|------|
| | A | B | C | D | E | F | G | H | J |
| FG | 262 | 231 | 77.5 | 10.5 | 15.5 | 38.0 | 167 | 74 | 6.4 |
| GF | 210 | 184 | 80.5 | 10.5 | 15.5 | 25.4 | 133 | 83.0 | 9.5 |
| GG710 & 800 | 262 | 231 | 77.5 | 10.5 | 15.5 | 38.0 | 165 | 83.0 | 6.4 |
| GG1000 & 1250 | | 228.5 | 84.0 | | | | | 100 | 12.7 |

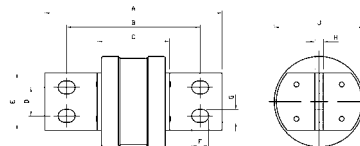

| Part No | Dimensions (mm) | | | | | | | | |
|---------------|-----------------|-----|------|------|------|------|------|-----|------|
| | A | B | C | D | E | F | G | H | J |
| GH710 & 800 | 198 | 149 | 81.0 | 32.0 | 63.5 | 19.0 | 14.0 | 9.5 | 83.0 |
| GH1000 & 1250 | | | | | | | | | 100 |

Data Sheets: FG: 4122 / GG: 4104 / GH: 4108

Industrial & Motor Applications to BS88

Offset Blade Tags
240 - 550V / 2 - 63A

Specifications

Description: Fuse Links for general industrial applications with Q1 fusing factor - general purpose (gG) and motor protection (gM) characteristics.



Ratings:

- Volts: - 240V ac (SSD)
 - 415V ac (NSD gM) / ESD gG (40 - 63A)
 - 550V ac (NSD gG) / ESD gG (2 - 32A)
- Amps: - 2 - 63A
 IR - 33kA @ 240V ac
 - 80kA @ 500V ac

Applications: General Industrial and Motors applications

Agency Information: Meets BS88: Part 6, 1988 and IEC 269: Parts 1, 1986

RoHS Compliant

Dimensions

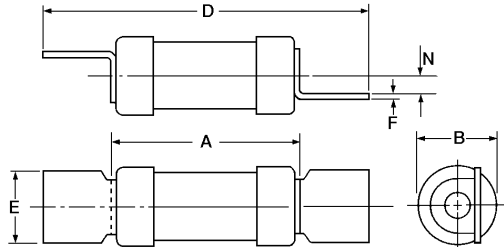

| Part No | Dimensions (mm) | | | | | |
|-------------------|-----------------|------|------|------|-----|-----|
| | A | B | D | E | F | N |
| SSD | 23.0 | 12.0 | 47.0 | 13.0 | 0.8 | 3.2 |
| NSD & NSD20M | 34.5 | 13.8 | 58.5 | 12.7 | 0.8 | 3.5 |
| NSD20M36 & NSD32M | | 17.5 | | | | |
| ESD - 32A | 35.5 | 13.8 | 68.0 | 15.0 | 1.2 | 3.5 |
| ESD40 - 63A | | 17.5 | | | | |
| ESD63M | | 21.0 | | | | |

Catalogue Numbers

| Rating (A) | Catalogue Number | Class | BS Reference | Fuseholder | Unit Packing |
|------------|------------------|-------|--------------|------------|--------------|
| 2 | SSD2 | gG | E1 | N/A | 20 |
| 4 | SSD4 | | | | |
| 6 | SSD6 | | | | |
| 10 | SSD10 | | | | |
| 16 | SSD16 | | | | |
| 20 | SSD20 | | | | |
| 32 | SSD32 | | | | |

| Rating (A) | Catalogue Number | Class | BS Reference | Fuseholder | Unit Packing |
|------------|------------------|-------|--------------|----------------|--------------|
| 2 | NSD2 | gR | F1 | SAFELOC 32NNSF | 20 |
| 4 | NSD4 | | | | |
| 6 | NSD6 | | | | |
| 10 | NSD10 | | | | |
| 16 | NSD16 | | | | |
| 20 | NSD20 | | | | |
| 32 | NSD32 | | | | |
| 20M25 | NSD20M25 | gM | F1 | SAFELOC 32NNSF | 20 |
| 20M32 | NSD20M32 | | | | |
| 20M36 | NSD20M36 | | | | |
| 32M36 | NSD32M36 | | | | |
| 32M40 | NSD32M40 | | | | |
| 32M50 | NSD32M50 | | | | |
| 32M63 | NSD32M63 | | | | |

| Rating (A) | Catalogue Number | Class | BS Reference | Fuse Holder | Unit Packing |
|------------|------------------|-------|--------------|----------------|--------------|
| 2 | ESD2 | gG | F2 | SAFELOC 63ENSF | 20 |
| 4 | ESD4 | | | | |
| 6 | ESD6 | | | | |
| 10 | ESD10 | | | | |
| 16 | ESD16 | | | | |
| 20 | ESD20 | | | | |
| 32 | ESD32 | | | | |
| 40 | ESD40 | | | | |
| 50 | ESD50 | | | | |
| 63 | ESD63 | | | | |
| 63M80 | ESD63M80 | gM | F2 | SAFELOC 63ENSF | 20 |
| 63M100 | ESD63M100 | | | | |

Data Sheet SSD: 4105
 Data Sheet NSD: 4100

Point of Sale Stand

Merchandising Stand

Specifications

Description: Merchandising stand with BS88 fuses packed in packs of 3's or 10's

Stand dimensions: 1.88 Metre tall x 0.91 Metre wide x 0.51 Metre deep* (including hooks)



Please note this stand is for the UK market only

Catalogue Numbers

| Part Number | Part Description | Pack Qty (Nb of fuses per pack) | Outer box Qty (MOQ) |
|-------------|---------------------------------|---------------------------------|---------------------|
| M-AAO10 | 10A 550V BS88 Fuse | 3 | 30 |
| M-AAO16 | 16A 550V BS88 Fuse | 3 | 30 |
| M-AAO20 | 20A 550V BS88 Fuse | 3 | 30 |
| M-AAO25 | 25A 550V BS88 Fuse | 3 | 30 |
| M-AAO32 | 32A 550V BS88 Fuse | 3 | 30 |
| M-BAO40 | 40A 550V BS88 Fuse | 3 | 30 |
| M-BAO50 | 50A 550V BS88 Fuse | 3 | 30 |
| M-BAO63 | 63A 550V BS88 Fuse | 3 | 30 |
| M-CD100 | 100A 550V BS88 Fuse | 3 | 30 |
| M-CEO80 | 80A 550V BS88 Fuse | 3 | 30 |
| M-CEO100 | 100A 550V BS88 Fuse | 3 | 30 |
| M-NITD2 | 2A 550V BS88 Fuse | 3 | 30 |
| M-NITD10 | 10A 550V BS88 Fuse | 3 | 30 |
| M-NITD16 | 16A 550V BS88 Fuse | 3 | 30 |
| M-NITD20 | 20A 550V BS88 Fuse | 3 | 30 |
| M-NITD32 | 32A 550V BS88 Fuse | 3 | 30 |
| M-C180-3A | 3A BS1362 Fuse | 10 | 100 |
| M-C180-5A | 5A BS1362 Fuse | 10 | 100 |
| M-C180-13A | 13A BS1362 Fuse | 10 | 100 |
| M-NSD4 | 4A 550V BS88 Fuse | 3 | 30 |
| M-NSD6 | 6A 550V BS88 Fuse | 3 | 30 |
| M-NSD10 | 10A 550V BS88 Fuse | 3 | 30 |
| M-NSD16 | 16A 550V BS88 Fuse | 3 | 30 |
| M-NSD20 | 20A 550V BS88 Fuse | 3 | 30 |
| M-NSD32 | 32A 550V BS88 Fuse | 3 | 30 |
| M-NITD6 | 6A 550V BS88 Fuse | 3 | 30 |
| M-STD6 | 6A 240V BS88 Fuse | 3 | 30 |
| M-STD10 | 10A 240V BS88 Fuse | 3 | 30 |
| M-32NNSF | 32A Safeloc Fuseholder | 1 | 5 |
| M-63ENSF | 63A Safeloc Fuseholder | 1 | 5 |
| M-CM20F | 20A Camaster Fuseholder | 1 | 5 |
| M-CM32FC | 32A Camaster Fuseholder Compact | 1 | 5 |
| M-CM32F | 32A Camaster Fuseholder | 1 | 5 |
| M-CM63F | 63A Camaster Fuseholder | 1 | 5 |
| M-CM100F | 100A Camaster Fuseholder | 1 | 5 |

Industrial Applications to BS88 - 500Vdc

**Special DC Range
Offset/Centre Bolted Tag
500Vdc / 10 - 63A**

Specifications

Description: Fuse links for industrial DC applications available in offset and centre bolted tags

Ratings:

- Volts: - 500V dc
- Amps: - 10 - 63A
- IR - 40kA @ 500V dc

Applications: Protection of DC electrical circuits

Agency information: ASTA approved to BS88 part 2

RoHS Compliant

Dimensions



Catalogue Numbers

| Rating (A) | Offset Bolted | Center fixings Centre Bolted | | Unit Packing |
|------------|---------------|------------------------------|--------|--------------|
| | 73mm | 98mm | 111mm | |
| 10 | 10HS07 | - | 10KS09 | 20 |
| 16 | 16HS07 | - | 16KS09 | |
| 20 | 20HS07 | - | 20KS09 | |
| 25 | 25HS07 | - | 25KS09 | |
| 32 | 32HS07 | - | 32KS09 | |
| 40 | 40KS07 | 40KS08 | 40KS09 | |
| 50 | 50KS07 | 50KS08 | 50KS09 | |
| 63 | 63KS07 | 63KS08 | 63KS09 | |

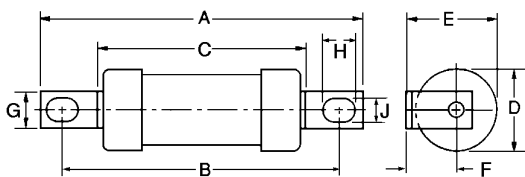

| Part No | Dimensions (mm) | | | | | | | |
|---------|-----------------|----|------|------|-----|------|------|-----|
| | A | B | C | D | F | G | H | J |
| HS07 | 86.0 | 73 | 54.0 | 22.0 | 0.8 | 9.2 | 8.0 | 5.0 |
| KS07 | 91.0 | | | 27.0 | 1.2 | 13.0 | 10.5 | |

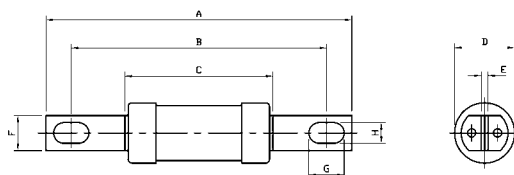

| Part No | Dimensions (mm) | | | | | | | |
|---------|-----------------|-----|------|------|-----|------|------|-----|
| | A | B | C | D | E | F | G | H |
| KS08 | 113.0 | 98 | 56.0 | 27.0 | 2.5 | 13.0 | 13.0 | 5.0 |
| KS09 | 138.0 | 111 | | | | 14.5 | 15.0 | 8.0 |

Data Sheet: E5785017

Industrial Applications to BS88 - 660/690V

Offset Bolted Tags
660-690V / 2 - 200A

Specifications

Description: Fuse links for industrial applications at 660/690V that meets dimensional and performance requirements of BS88 and IEC 269-1-2 standards



Ratings:

- Volts: - 660 / 690V ac
- 250V dc (2 - 63A)
- 400V dc (80 - 200A)
- Amps: - 2 - 200A
- IR - 80kA @ 660V ac
- 40kA @ 400V dc

Applications: Protection of large industrial installations at 600/690Vac

Agency information: Meets BS88: Part 1 & 2 and IEC 269: Parts 1 & 2

RoHS Compliant

Catalogue Numbers

| Rating (A) | Catalogue Number | BS Reference | Unit Packing | CAMaster fuseholder |
|------------|------------------|--------------|--------------|---------------------|
| 2 | 2H07-660 | A2 | 20 | CM32F |
| 4 | 4H07-660 | | | |
| 6 | 6H07-660 | | | |
| 10 | 10H07-660 | | | |
| 16 | 16H07-660 | | | |
| 20 | 20H07-660 | | | |
| 25 | 25H07-660 | A3 | 20 | CM63F CM100F |
| 32 | 32H07-660 | | | |
| 40 | 40K07-660 | | | |
| 50 | 50K07-660 | A4 | 10 | N/A |
| 63 | 63K07-660 | | | |
| 80 | 80L14-660 | N/A | 5 | N/A |
| 100 | 100L14-660 | | | |
| 125 | 125M14-660 | | | |
| 160 | 160M14-660 | | | |
| 200 | 200M14-660 | | | |

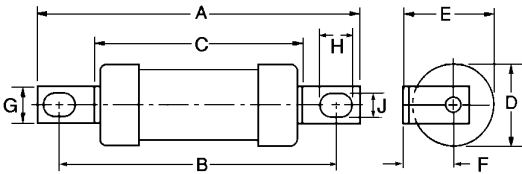

| Part No | Dimensions (mm) | | | | | | | | |
|---------|-----------------|----|------|------|------|------|------|------|-----|
| | A | B | C | D | E | F | G | H | J |
| H07-660 | 82.3 | 73 | 52.0 | 22.0 | 22.4 | 11.5 | 8.7 | 7.7 | 5.4 |
| K07-660 | 86.0 | 73 | 54.2 | 25.8 | 26.9 | 14.0 | 12.7 | 10.5 | 5.5 |
| L14-660 | 111.0 | 94 | 67.0 | 35.5 | 37.0 | 19.2 | 19.0 | 10.3 | 8.7 |
| M14-660 | 112.0 | 94 | 66.0 | 38.0 | 38.0 | 19.0 | 19.0 | 10.0 | 8.5 |

- Data Sheet H07: 4150
- Data Sheet K07: 4151
- Data Sheet L14: 4152
- Data Sheet M14: 4153

Industrial Applications to BS88 - 660/690V

Centre Bolted Tags
660 - 690V ac / 2 - 630A
250 - 400V dc



Specifications

Description: Fuse Links for industrial applications at 660/690V that meets dimensional and performance requirements of BS88 and IEC 269-1-2 standards.

Ratings:

- Volts: - 660 / 690V ac
- 250V dc (2 - 63A) (K08, K09)
- 400V dc (80 - 630A) (L09, M09, N09, P09, N11, P11, P12, R11, R12)
- Amps: - 2 - 630A
- IR - 80kA @ 660V ac
- 40kA @ 250V dc/400V dc

Applications: Protection of large industrial installations at 660/690Vac

Agency Information: Meets BS88: Part 1 & 2 and IEC 269: Parts 1 & 2

RoHS Compliant

Dimensions

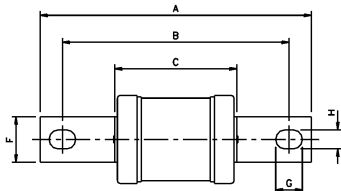

| Part No | Dimensions (mm) | | | | | | | |
|----------------|-----------------|------|------|------|-----|------|------|-----|
| | A | B | C | D | E | F | G | H |
| K08-660 2-32A | 111.0 | 92.5 | 53.7 | 22.0 | 2.4 | 12.7 | 13.0 | 7.5 |
| K08-660 40-63A | 111.5 | 93.0 | 54.2 | 25.0 | | | | |
| K09-660 2-32A | 127.0 | 111 | 53.7 | 22.0 | 2.4 | 14.0 | 15.2 | 8.7 |
| K09-660 40-63A | 128.0 | 111 | 54.2 | 25.0 | | | | |

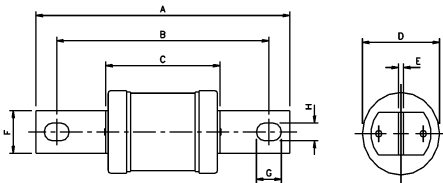

| Part No | Dimensions (mm) | | | | | | | |
|---------|-----------------|-----|------|------|-----|------|------|------|
| | A | B | C | D | E | F | G | H |
| L09-660 | 136.0 | 111 | 65.5 | 35.5 | 3.2 | 19.0 | 15.1 | 8.7 |
| M09-660 | 135.0 | 111 | 65.0 | 37.0 | 3.2 | 19.0 | 15.0 | 8.7 |
| N09-660 | 135.0 | 111 | 73.0 | 49.0 | 3.2 | 25.4 | 12.7 | 9.5 |
| P09-660 | 135.5 | 111 | 75.0 | 58.5 | 4.7 | 25.4 | 12.7 | 9.5 |
| N11-660 | 162.0 | 133 | 73.0 | 49.0 | 3.2 | 25.4 | 15.8 | 10.5 |

Catalogue Numbers

| Rating (A) | Catalogue Number | BS Reference | Fixing Centres (mm) | Unit Packing |
|------------|------------------|--------------|---------------------|--------------|
| 2 | 2K08-660 | N/A | 93 | 20 |
| 4 | 4K08-660 | | | |
| 6 | 6K08-660 | | | |
| 10 | 10K08-660 | | | |
| 16 | 16K08-660 | | | |
| 20 | 20K08-660 | | | |
| 32 | 32K08-660 | | | |
| 40 | 40K08-660 | | | |
| 50 | 50K08-660 | | | |
| 63 | 63K08-660 | | | |

| | | | | | |
|-----|------------|-----|-----|----|----|
| 2 | 2K09-660 | N/A | 111 | 20 | |
| 4 | 4K09-660 | | | | |
| 6 | 6K09-660 | | | | |
| 10 | 10K09-660 | | | | |
| 16 | 16K09-660 | | | | |
| 20 | 20K09-660 | | | | |
| 32 | 32K09-660 | | | | |
| 40 | 40K09-660 | | | | |
| 50 | 50K09-660 | | | | |
| 63 | 63K09-660 | | | | |
| 80 | 80L09-660 | | | | B1 |
| 100 | 100L09-660 | | | | B2 |
| 125 | 125M09-660 | | | | |
| 160 | 160M09-660 | B3 | | | |
| 200 | 200M09-660 | | | | |
| 250 | 250N09-660 | B4 | | | |
| 315 | 315N09-660 | | | | |
| 355 | 355P09-660 | B4 | | | |
| 400 | 400P09-660 | | | | |

| | | | | |
|-----|------------|-----|-----|---|
| 125 | 125N11-660 | N/A | 133 | 1 |
| 160 | 160N11-660 | | | |
| 200 | 200N11-660 | | | |
| 250 | 250N11-660 | | | |
| 315 | 315N11-660 | | | |

| | | | | |
|-----|------------|----|---------|---|
| 355 | 355P11-660 | C1 | 133/184 | 1 |
| 400 | 400P11-660 | | | |
| 450 | 450R11-660 | C2 | 133/184 | 1 |
| 500 | 500R11-660 | | | |
| 560 | 560R11-660 | | | |
| 630 | 630R11-660 | | | |

| | | | | |
|-----|------------|-----|---------|---|
| 355 | 355P12-660 | N/A | 167/231 | 1 |
| 400 | 400P12-660 | | | |
| 450 | 450R12-660 | | | |
| 500 | 500R12-660 | | | |
| 560 | 560R12-660 | | | |
| 630 | 630R12-660 | | | |

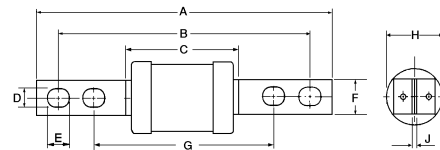

| Part No | Dimensions (mm) | | | | | | | | |
|---------|-----------------|-----|-----|------|------|------|------|------|-----|
| | A | B | C | D | E | F | G | H | J |
| P11-660 | 212.0 | 184 | 133 | 75.0 | 25.4 | 16.0 | 10.0 | 59.0 | 5.0 |
| P12-660 | 262.0 | 231 | 167 | | | | | | |
| R11-660 | 210.0 | 184 | 133 | 76.0 | 26.0 | 16.0 | 10.0 | 74.0 | 6.5 |
| R12-660 | 262.0 | 231 | 167 | | | | | | |

Data Sheets: K08: 415 / L09: 4156 / M09: 4157 / N09: 4158 / P09: 4159 / N11: 4160 / P11: 4161 / R11: 4162 / R12: 4162

Industrial Applications to BS88 - 660/690V

Special Tag Arrangements 660 - 690V / 125 - 800A

Specifications

Description: Fuse Links for industrial applications at 660/690V that meets dimensional and performance requirements of BS88 and IEC 269-1-2 standards.



Ratings:

- Volts: - 660 / 690V ac (except S20 type - 550V ac)
- 400V dc (except S20 type)
- Amps: - 125 - 800A
- IR - 80kA @ 660V ac
- 40kA @ 400V (except S20 type)

Applications: Protection of large industrial installations at 600 / 690Vac

Agency Information: BS88 part 1 section 2-1 & 2-2

RoHS Compliant

Dimensions

Offset Bolted Tag

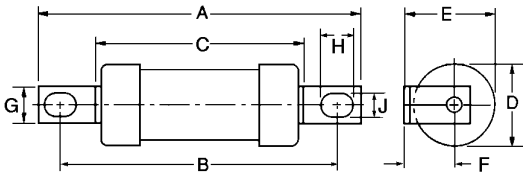

| Part No | Dimensions (mm) | | | | | | | | |
|---------|-----------------|-------|-------|------|------|------|------|------|-----|
| | A | B | C | D | E | F | G | H | J |
| M13 | 120.0 | 99.0 | 70.0 | 38.0 | 27.0 | 8.0 | 26.0 | 12.0 | 8.7 |
| M23 | 262.0 | 231.0 | 167.0 | | 38.5 | 19.0 | | 14.0 | |
| N15 | 120.0 | 100.0 | 79.0 | 49.0 | 41.0 | 16.5 | | 15.0 | 9.8 |

Special Tag Arrangement

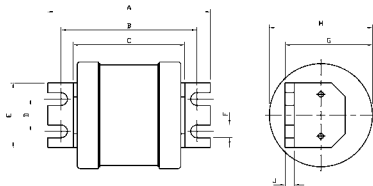

| Part No | Dimensions (mm) | | | | | | | | |
|---------|-----------------|------|------|------|------|-----|------|------|-----|
| | A | B | C | D | E | F | G | H | J |
| N20 | 110.0 | 92.0 | 75.0 | 22.0 | 44.5 | 8.8 | 49.0 | 49.0 | 6.4 |
| P20 | 111.0 | | 76.0 | | | | 47.0 | 59.0 | |
| R20 | 112.0 | 94.0 | 77.0 | | | | 62.0 | 74.0 | |
| S20 | 112.0 | | 77.0 | | | | 66.0 | 83.0 | |

Catalogue Numbers

| Tag Types | Rating (A) | Catalogue Number | Fixing Centres (mm) | Unit Packing | |
|--------------------|------------|------------------|---------------------|--------------|---|
| Offset Bolted Tag | 125 | 125M13 | 99 | 5 | |
| | 160 | 160M13 | | | |
| | 200 | 200M13 | | | |
| | 250 | 250M13 | | | |
| | 315 | 315M13 | | | |
| | 125 | 125M23 | 231 | | 1 |
| 160 | 160M23 | | | | |
| 200 | 200M23 | | | | |
| Centre Bolted Tag | 250 | 250N15 | 100 | 1 | |
| | 315 | 315N15 | | | |
| | 250 | 250N34 | 113 | | 1 |
| | 315 | 315N34 | | | |
| | 355 | 355P35 | 133/184 | | 1 |
| | 400 | 400P35 | | | |
| Special Offset Tag | 450 | 450R40 | 133/184 | 1 | |
| | 500 | 500R40 | | | |
| Special Offset Tag | 125 | 125N20 | 92.5 | 1 | |
| | 160 | 160N20 | | | |
| | 200 | 200N20 | | | |
| | 250 | 250N20 | | | |
| | 315 | 315N20 | | | |
| | 355 | 355P20 | 92.5 | | 1 |
| | 400 | 400P20 | | | |
| | 450 | 450R20 | 94 | | 1 |
| | 500 | 500R20 | | | |
| | 560 | 560R20 | | | |
| 630 | 630R20 | | | | |
| 710 | 710S20 | | | | |
| 800 | 800S20 | 94 | 1 | | |

Centre Bolted Tag

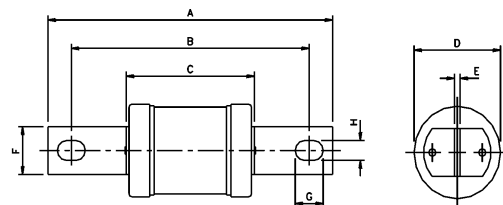

| Part No | Dimensions (mm) | | | | | | | |
|---------|-----------------|-----|------|------|-----|------|------|-----|
| | A | B | C | D | E | F | G | H |
| N34 | 135.0 | 111 | 74.5 | 66.5 | 5.0 | 25.4 | 12.5 | 9.5 |

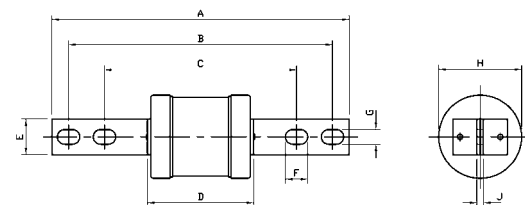

| Part No | Dimensions (mm) | | | | | | | | |
|---------|-----------------|-----|-----|------|------|------|------|------|-----|
| | A | B | C | D | E | F | G | H | J |
| P35 | 210.0 | 184 | 133 | 75.0 | 19.0 | 16.0 | 10.0 | 59.0 | 5.0 |
| R40 | | | | 81.0 | | | | 74.0 | |

Data Sheets: M13 & M23: 4153 / N15: 4164 / N34: 4165 / P35: 4161 / R40: 4162 / N20: 4166 / P20: 4167 / R20: 4168 / S20: E5785045

Street Lighting Applications to BS88

Offset Bolted Tags 240 - 550V / 2 - 32A

Specifications

Description: Fuse Links for general street lighting applications with Q1 fusing factor - general purpose (gG)

Applications: Street lighting applications

Ratings:

- Volts: - 240 - 415V ac
- Amps: - 2 - 32A
- IR - 33kA @ 240V ac (STD)
- 80kA @ 415 / 550V ac (SMD)

Agency information: Meets BS88: Part 1 & 2 (1988), IEC 269: Parts 1 (1986)

RoHS Compliant

SMD 415V ac (gG) / 2 - 32A



Catalogue Numbers

| Rating (A) | Part Reference | Unit Packing |
|------------|----------------|--------------|
| 2 | SMD2 | 20 |
| 4 | SMD4 | |
| 6 | SMD6 | |
| 10 | SMD10 | |
| 16 | SMD16 | |
| 20 | SMD20 | |
| 25 | SMD25 | |
| 32 | SMD32 | |

Dimensions

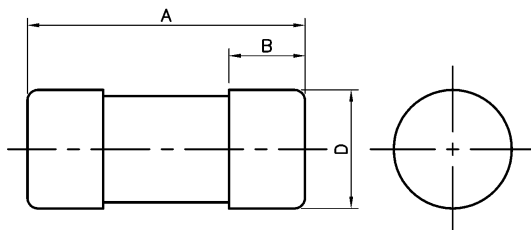

| Part No | Dimensions (mm) | | | |
|---------|-----------------|---|---|------|
| | A | B | C | D |
| SMD | 29.0 | - | - | 12.7 |

Also available as Offset Bladed Tags "SSD", see page 10

STD 240V ac / 2 - 32A



Catalogue Numbers

| Rating (A) | Part Reference | Unit Packing |
|------------|----------------|--------------|
| 2 | STD2 | 20 |
| 4 | STD4 | |
| 6 | STD6 | |
| 10 | STD10 | |
| 16 | STD16 | |
| 20 | STD20 | |
| 25 | STD25 | |
| 32 | STD32 | |

Dimensions

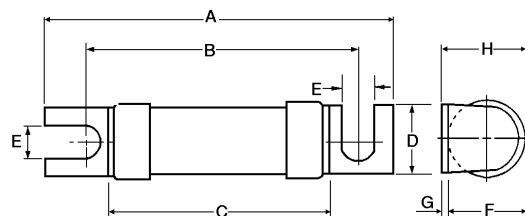

| Part No | Dimensions (mm) | | | | | | | |
|---------|-----------------|----|------|------|-----|------|-----|------|
| | A | B | C | D | E | F | G | H |
| STD | 47.0 | 35 | 24.0 | 11.0 | 4.7 | 12.0 | 0.8 | 13.0 |

Data Sheet: 4123

Utility Applications to BS88

House Service Cut-Out Fuse Links 415V / 5 - 100A

Specifications

Description: Cylindrical Fuse Links for electrical utilities to BS Standard

Ratings:

Volts: - 415V
Amps: - 5 - 100A
IR - 33kA @ 415V

Applications: Fuses to use in connection with House Service cut-outs.

Agency Information: ASTA certified and tested in accordance to BS 1361

RoHS Compliant

Catalogue Numbers

| Rating (A) | Catalogue Number | | Unit Packing |
|------------|------------------|---------|--------------|
| | Diameter | | |
| | 22mm | 30mm | |
| 5 | 5KR85 | - | 20 |
| 10 | 10KR85 | - | |
| 15 | 15KR85 | - | |
| 20 | 20KR85 | - | |
| 25 | 25KR85 | - | |
| 30 | 30KR85 | 30LR85 | |
| 40 | 40KR85 | 40LR85 | |
| 45 | 45KR85 | - | |
| 50 | 50KR85 | 50LR85 | |
| 60 | 60KR85 | 60LR85 | |
| 70 | 70KR85 | - | |
| 80 | 80KR85 | 80LR85 | |
| 90 | 90KR85 | - | |
| 100 | 100KR85 | 100LR85 | |



Dimensions

KR85 Type

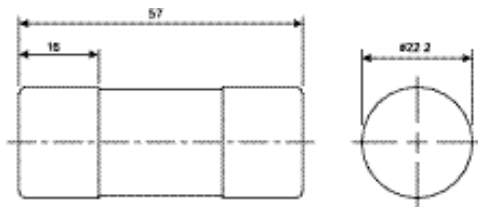

LR85 Type

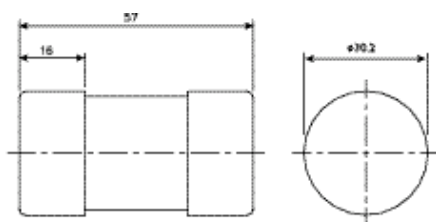

Data Sheet KR85: 4185
Data Sheet LR85: 4186

J Type Fuse Links to BS88: Part 5 Cylindrical Type 415V / 20 - 250A

Specifications

Description: Cylindrical type fuses designed for use with wedge type fuse carriers on BS applications

Ratings:

Volts: - 415V
Amps: - 20 - 250A
IR - 80kA @ 415V

Applications: For use by Electrical Authorities in distribution pillars, open type substation boards, heavy duty cut-outs, and underground connection boxes. Cylindrical type to be used in pole or wall mounted outdoor service fuse units.

Agency information: ASTA certified and tested to BS88: Part 5

RoHS Compliant

Catalogue Numbers:

| Rating (A) | Catalogue Number | Unit Packing |
|------------|------------------|--------------|
| 20 | 20MJ25-6 | 20 |
| 32 | 32MJ25-6 | |
| 40 | 40MJ25-6 | |
| 63 | 63MJ25-6 | |
| 80 | 80MJ25-6 | |
| 100 | 100MJ25-6 | |
| 125 | 125MJ25-6 | |
| 160 | 160MJ25-6 | |
| 200 | 200MJ25-6 | |
| 250 | 250MJ25-6 | |



Dimensions

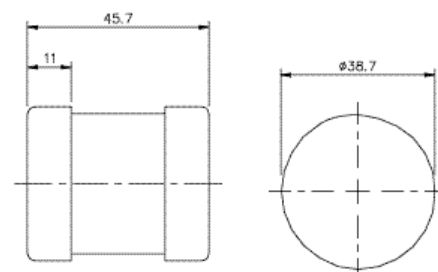

Data Sheet: 4177

Utility Applications to BS88

J Type Fuse Links to BS88: Part 5 Slotted/Non Slotted Types 415V / 20 - 800A

Specifications

Description: Slotted type fuses designed for use with wedge type fuse carriers on BS applications



Ratings:

- Volts: - 415V
- Amps: - 20 - 630A (Slotted Type)
- 800A (Non Slotted Type)
- IR - 80kA @ 415V

Applications: For use by Electrical Authorities in distribution pillars, open type substation boards, heavy duty cut-outs, and underground connection boxes.

Agency information: ASTA certified and tested BS88: Part 5

RoHS Compliant

Dimensions

| Type | A | B | C | D | E | F | G | H | I | J | K |
|---------------------|-------|----|------|------|------|------|------|------|------|-----|-----------|
| MJ30-8 | 110 | 82 | 45.2 | 40.5 | 30 | 14.8 | 17.5 | 9.8 | 30.9 | 2.4 | 6.45/6.53 |
| MJ30-7 (Up to 200A) | 110 | 82 | 45.2 | 40.5 | 30 | 14.8 | 17.5 | 9.8 | 30.9 | 2.4 | 6.45/6.53 |
| MJ30-7 (315-400A) | 110 | 82 | 44.8 | 40 | 30 | 14.4 | 17.5 | 9.8 | 38 | 2.4 | 6.45/6.53 |
| MJ31-7 (Up to 200A) | 131 | 92 | 46.8 | 40.5 | 41 | 17.4 | 20.7 | 10.9 | 30.8 | 3.2 | 8.05/8.73 |
| MJ31-7 (315-400A) | 131 | 92 | 46.4 | 40 | 41 | 17.4 | 20.7 | 10.2 | 38.1 | 3.2 | 8.05/8.73 |
| PJ30-7 | 110 | 82 | 44.8 | 40 | 30 | 14.4 | 17.5 | 9.8 | 38 | 2.4 | 6.45/6.53 |
| PJ31-7 | 131 | 92 | 46.4 | 40 | 41 | 17.4 | 20.7 | 10.2 | 38.1 | 3.2 | 8.05/8.73 |
| RJ31-7 | 131 | 92 | | 45 | 38 | 16.5 | 15.5 | 10.9 | 49.1 | 3.2 | 8.05/8.73 |
| SJ31-6 | 128.5 | 92 | | 44.5 | 38.1 | 16.5 | 20.6 | 11 | 73.3 | 3.2 | 8.05/8.73 |
| SJ28 | 128.5 | 92 | | 44.5 | 38.1 | 16.5 | 20.5 | | 73.3 | 3.2 | 8.05/8.73 |

Slotted Type (MJ31-7 up to 200A)

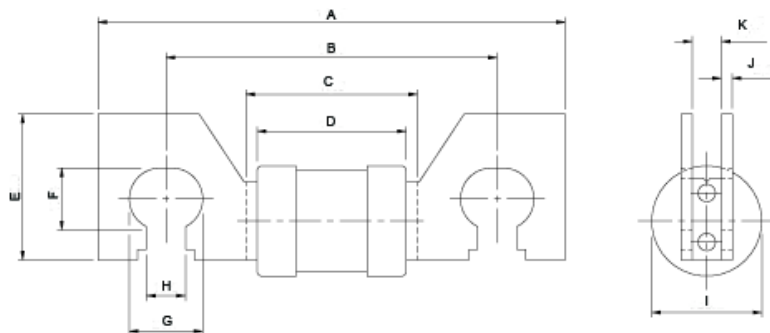

Data Sheets: MJ30-8: 4178A / MJ30-7: 4178B / MJ31-7 or 8: 4180 / PJ31: 4181 / RJ: 4182 / SJ: 4183

Catalogue Numbers

| Rating (A) | Slotted Fixing Center | | | Non Slotted | Unit Packing |
|------------|-----------------------|-----------|-----------|-------------|--------------|
| | 76mm | 82mm | 92mm | | |
| 20 | - | - | 20MJ31-8 | - | 10 |
| 25 | - | - | 25MJ31-8 | - | |
| 32 | - | 32MJ30-8 | 32MJ31-8 | - | |
| 40 | - | 40MJ30-8 | 40MJ31-8 | - | |
| 50 | - | 50MJ30-8 | 50MJ31-8 | - | |
| 63 | 63MJ29-6 | 63MJ30-8 | 63MJ31-8 | - | |
| 80 | 80MJ29-6 | 80MJ30-7 | 80MJ31-7 | - | |
| 100 | 100MJ29-6 | 100MJ30-7 | 100MJ31-7 | - | |
| 125 | - | 125MJ30-7 | 125MJ31-7 | - | |
| 160 | 160MJ29-6 | 160MJ30-7 | 160MJ31-7 | - | |
| 200 | 200MJ29-6 | 200MJ30-7 | 200MJ31-7 | - | |
| 250 | 250MJ29-6 | 250MJ30-7 | 250MJ31-7 | - | |
| 315 | - | 315MJ30-7 | 315MJ31-7 | - | |
| 355 | - | 355PJ30-7 | 355PJ31-7 | - | |
| 400 | - | 400PJ30-7 | 400PJ31-7 | - | |
| 450 | - | - | 450RJ31-7 | - | |
| 500 | - | - | 500RJ31-7 | - | |
| 560 | - | - | 560SJ31-6 | - | |
| 630 | - | - | 630SJ31-6 | - | |
| 800 | - | - | | 800SJ28 | |

Joint NATO Reference System

Cylindrical/Offset Bolted Tag
440V / 0.25 - 150A



Specifications

Description: Cylindrical Fuse links originally developed for the Admiralty but are now used in a wide variety of applications

Ratings:

- Volts: - 440V
- Amps: - 0.25 - 100A (Cylindrical)
- 0.5 - 150A (Offset Bolted Tag)
- IR - 33kA @ 440Vac

Applications: defence, aeronautical, allied industries, electronics

Agency information: Defence standard 59-96 (superceding DEF 63). Tested to BS88 at 440V/33kA

RoHS Compliant

Dimensions

Cylindrical

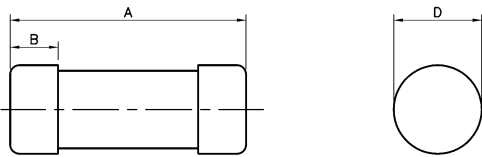

| Size | A | D | B |
|------|-------|-------|------|
| 0 | 32.05 | 6.37 | 5.55 |
| 1 | 33.6 | 11.86 | 7.14 |
| 2 | 37.6 | 16.7 | 8.71 |
| 3 | 47.9 | 33.3 | 11.9 |

Offset Bolted Tag

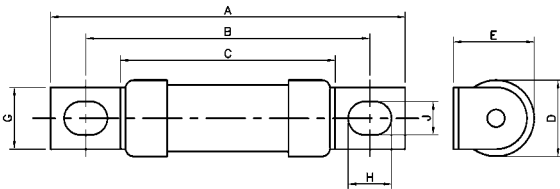

| Size | A | B | C | D |
|------|-------|-------|------|-------|
| 1 | 56.03 | 44.65 | 33.9 | 11.96 |
| 2 | 70.7 | 55.84 | 37.4 | 16.7 |
| 3 | 88.6 | 69.77 | 47.4 | 33.3 |

Catalogue Numbers

| Size | Rating (A) | Cylindrical | Offset Bolted | Unit Packing |
|------|------------|-------------|--|--------------|
| 0 | 0.25 | 059-0107 | N/A | 100 |
| | 0.5 | 059-0108 | | |
| | 1 | 059-0109 | | |
| | 2 | 059-0110 | | |
| | 3 | 059-0111 | | |
| | 5 | 059-0112 | | |
| | 7 | 059-0113 | | |
| | 10 | 059-9925 | | |
| 1 | 15 | 059-9926 | 059-0114 059-0115 059-0116 059-0117 059-0118 059-0119 059-0120 059-0121 011-9679 012-0140 | 25 |
| | 0.5 | 059-0140 | | |
| | 1 | 059-0141 | | |
| | 2 | 059-0142 | | |
| | 3 | 059-0143 | | |
| | 5 | 059-0144 | | |
| | 7 | 059-0145 | | |
| | 10 | 059-0146 | | |
| | 15 | 059-0147 | | |
| | 20 | 011-9483 | | |
| 2 | 30 | 012-0140 | 059-0148 059-0149 059-0150 059-0151 059-0125 059-0067 011-9127 012-0141 | 25 |
| | 10 | 059-0148 | | |
| | 15 | 059-0149 | | |
| | 20 | 059-0150 | | |
| | 30 | 059-0151 | | |
| | 40 | 059-0125 | | |
| 3 | 40 | 059-0152 | 059-0126 059-0127 059-0128 059-0129 011-9128 011-9129 | 25 |
| | 50 | 059-0153 | | |
| | 80 | 059-0154 | | |
| | 100 | 059-0155 | | |
| | 125 | 059-0129 | | |
| | 160 | 011-9128 | | |

BS88 Fuseholders

CM

CAMASTER HRC Fuseholder 690V ac / 20 - 400A



Specifications

Description: Fully shrouded fuse bases with unique cam action system for BS88 Fuse link applications.

Ratings:

- Volts: - 660V ac
- Amps: - 20, 32 (Compact) 32, 63 and 100A

Applications: Lighting and heating equipment, circuit protection, Motor protection, Control equipment circuit protection

Agency Information: CE Compliance to BS88, EN IEC 60269. For UL and CSA approved versions also available, consult Cooper Bussmann®

RoHS Compliant

Dimensions

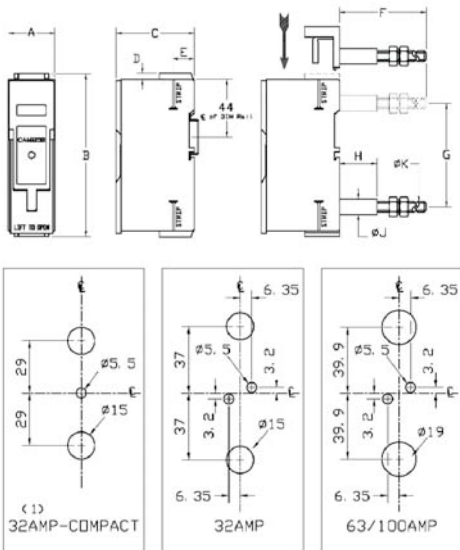

| Cat. No | Max cable mm ² | Dimensions (mm) | | | | | | | | | |
|---------|---------------------------|-----------------|-------|-------|------|------|------|------|------|------|-----|
| | | A | B | C | D | E | F | G | H | J | K |
| CM20F | 16 | 25.4 | 93.7 | 60 | 3.2 | 17.5 | 66.0 | 58.0 | 28.6 | 11.9 | M6 |
| CM32FC | 16 | 25.4 | 93.7 | 60 | 3.2 | 17.5 | 66.0 | 58.0 | 28.6 | 11.9 | M6 |
| CM32F | 16 | 31.8 | 117.5 | 60 | 3.2 | 17.5 | 66.0 | 74.0 | 28.6 | 11.9 | M6 |
| CM63F | 70 | 35.6 | 125 | 60 | 4.75 | 16.4 | 86.5 | 81.0 | 28.6 | 11.9 | M8 |
| CM100F | 70 | 35.6 | 125 | 60 | 4.75 | 16.4 | 86.5 | 81.0 | 28.6 | 11.9 | M8 |
| 200DF | 95 | 70 | 193 | 149 | 17.5 | 35.6 | 8 | 138 | 30 | 24 | M12 |
| 400EF | 240 | 98.4 | 254 | 192.1 | 31.8 | 36.5 | - | - | - | - | - |

Catalogue Numbers

| Rating (A) | Catalogue Number | Recommended Fuse Link | Unit Packing |
|------------|--------------------|-----------------------|--------------|
| 20 | CM20F | NITD | 10 |
| 32 | CM32FC | NITD | 10 |
| 32 | CM32F | AAO | 10 |
| 63 | CM63F | BAO | 10 |
| 100 | CM100F | OSD | 5 |
| 200* | 200DF | DD | |
| | 200DFBS Front/Back | | |
| | 200DBS Back/Back | | |
| 400* | 400EF | ED | |

* 200A & 400A do not have the CAM action

Accessories Numbers

| Accessory | Rating (A) | Catalogue No | Unit Packing |
|--------------------------|------------|--------------|--------------|
| Back Stud | 32 | 32BSC | 10 |
| | 32 | 32BS | 10 |
| | 63/100 | 63/100BS | 5 |
| Ganging Links | | GLP | 1 set |
| Neon Indicator | 90-415V ac | NI | 3 |
| Lockable Safety Carriers | | 32LSCC | 3 |
| | | 32LSC | 3 |
| | | 63/100LSC | 3 |
| Neutral Links | 32 | 32CMLC | 1 |
| | 32 | 32CML | |
| | 63/100 | 63/100CML | |
| Security Clip | | CMSC | 20 |

Notes:

- 1 - Type CM32FC is also available rated at 20A, catalogue number CM20F
- 2 - For colours other than Black (standard) add the appropriate letter code: W = White; G = Green, GY = Grey
- 3 - Care must be taken when fitting solid single or stranded cables of small cross-sectional area to ensure correct clamping. Small Multi-stranded cables must be terminated with bootlace ferrules to ensure correct clamping. Bootlace ferrules should not be used on standard power cables or high current applications. If in doubt please consult Cooper Bussmann®
- 4 - A +5% tolerance should be allowed on dimensions when cutting metal work to fit CAMaster fuse holders

BS88 Fuseholders

NNS, ENS Safeloc Fuseholder 660V ac / 32 - 63A



Specifications

Description: Fuseholder to be used with BS88 Fuse links for bolted panel mounting or DIN rail.

Ratings:

Volts: - 550V ac, 415V ac (63A)
Amps: - 32, 63A

Applications: Lighting and heating equipment, circuit protection, Motor protection, Control equipment circuit protection

Agency Information: CE Compliance to BS88, EN IEC 60269

RoHS Compliant

Dimensions

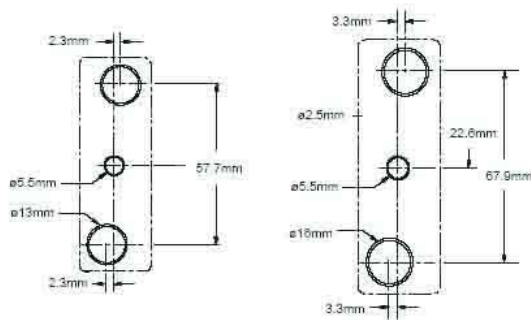

| Rating (A) | Part No | Max Cable mm ² | Dimensions (mm) | | | | | | | | | |
|------------|---------|---------------------------|-----------------|------|------|-----|------|------|------|------|------|----|
| | | | A | B | C | D | E | F | G | H | J | K |
| 32 | NNS | 16 | 25.4 | 80.3 | 48.5 | 2.3 | 16.0 | 39.2 | 57.7 | 17.0 | 9.7 | M6 |
| 63 | ENS | 35 | 29.1 | 90.0 | 55.0 | 3.3 | 17.7 | 75.0 | 67.9 | 39.2 | 11.0 | M8 |

Catalogue Numbers

| Rating (A) | Catalogue Number | Available Variants | Required Fuse Link | Unit Packing |
|------------|------------------|-------------------------------------|--------------------|--------------|
| 32 | 32NNSF | Front connected/ Front connected | NSD | 10 |
| | 32NNSBS | Back stud/ Back stud | | 10 |
| | 32NNSFBS | Front connected/ Back stud | | 10 |
| | 32NNL | Neutral links | | 10 |
| 63 | 63ENSF | Front connected/ Front connected | ESD | 5 |
| | 63ENSBS | Back stud/ Back stud | | 5 |
| | 63ENSFBS | Front connected/ Back stud | | 5 |
| | 63ENL | Neutral links | | 1 |

Notes:

1 - For colours other than Black (standard), add the appropriate letter code: W = White, G = Green, GY = Grey, at the end of the catalogue reference.

2 - Security seal (ref. 32551) available for 32A Safeloc

3 - Care must be taken when fitting solid single or stranded cables of small cross-sectional area to ensure correct clamping. Small Multi-stranded cables must be terminated with bootlace ferrules to ensure correct clamping. Bootlace ferrules should not be used on standard power cables or high current applications. If in doubt please consult Cooper Bussmann®

4 - A +5% tolerance should be allowed on dimensions when cutting metal work to fit Safeloc fuse holders

Cylindrical Domestic Fuses

Class gG (gF)
250 - 400V / 0.5 - 32A
Sizes: 6x23, 8x23, 10x25
8x31, 10x31, 8x36
10x38



Specifications

Description: Cylindrical fuses for domestic protection. Available in types with and without striker indicator.

Ratings:

- Volts: - 250V ac (6x23, 8x23, 10x25)
- 400V ac (8x31, 10x31, 8x36, 10x38)
- Amps: - 0.5 - 32A
- IR - 6kA (6x23, 8x23, 10x25)
- 20kA (8x31, 10x31, 8x36, 10x36)

Applications: Protection of power lines, heating circuits, lighting circuits. electrical domestic appliances and domestic electricity meters

Agency Information: NF C 62203, EN IEC 60269-3, NF marking (see references in bold in catalogue numbers chart)

RoHS Compliant

Dimensions

| Size | A | B | C |
|---------|------|------|-----|
| 6 x 23 | 6.3 | 23 | 5 |
| 8 x 23 | 8.5 | 23 | 5 |
| 8 x 31 | 8.5 | 31.5 | 6.3 |
| 8 x 36 | 8.5 | 36 | 6.3 |
| 10 x 25 | 10.3 | 25.8 | 6.3 |
| 10 x 31 | 10.3 | 31.5 | 6.3 |
| 10 x 38 | 10.3 | 38 | 10 |

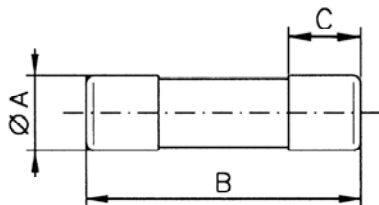

Catalogue Numbers



| Size | Current (A) | References without Indicator | References with Indicator | Voltage (V) | Interrupting Rating (kA) | UP* |
|-------|-------------|------------------------------|---------------------------|-------------|--------------------------|-----|
| 6x23 | 2 | CD0623G2 | | 250V | 6kA | 10 |
| | 4 | CD0623G4 | | | | |
| | 6 | CD0623G6 | | | | |
| | 10 | CD0623G10 | | | | |
| 8x23 | 2 | CD0823G2 | CD0823G2I | 250V | 6kA | 10 |
| | 4 | CD0823G4 | CD0823G4I | | | |
| | 6 | CD0823G6 | CD0823G6I | | | |
| | 10 | CD0823G10 | CD0823G10I | | | |
| | 16 | CD0823G16 | CD0823G16I | | | |
| 10x25 | 6 | CD1025G6 | CD1025G6I | 250V | 6kA | 10 |
| | 10 | CD1025G10 | CD1025G10I | | | |
| | 16 | CD1025G16 | CD1025G16I | | | |
| 8x31 | 0.5 | CD0831G0.5 | - | 400V | 20kA | 10 |
| | 1 | CD0831G1 | - | | | |
| | 2 | CD0831G2 | CD0831G2I | | | |
| | 4 | CD0831G4 | CD0831G4I | | | |
| | 6 | CD0831G6 | CD0831G6I | | | |
| | 8 | CD0831G8 | CD0831G8I | | | |
| | 10 | CD0831G10 | CD0831G10I | | | |
| | 12 | CD0831G12 | CD0831G12I | | | |
| | 16 | CD0831G16 | CD0831G16I | | | |
| | 20 | CD0831G20 | CD0831G20I | | | |
| | 10x31 | 16 | CD1031G16 | | | |
| 20 | | CD1031G20 | CD1031G20I | | | |
| 25 | | CD1031G25 | CD1031G25I | | | |
| | | | | | | |
| 8x36 | 2 | CD0836G2 | CD0836G2I | 400V | 20kA | 12 |
| | 4 | CD0836G4 | CD0836G4I | | | |
| | 6 | CD0836G6 | CD0836G6I | | | |
| | 10 | CD0836G10 | CD0836G10I | | | |
| | 16 | CD0836G16 | CD0836G16I | | | |
| | 20 | CD0836G20 | CD0836G20I | | | |
| | 25 | CD0836G25 | CD0836G25I | | | |
| | 32 | CD0836G32 | CD0836G32I | | | |
| | | | | | | |
| 10x38 | 25 | CD1038G25 | CD1038G25I | 400V | 20kA | 10 |
| | 32 | CD1038G32 | CD1038G32I | | | |

*UP = Unit Packing

NFC 60203

Domestic Fuses

AD
440V ac / 15 - 90A
Sizes: 10x38, 14x51,
22x58 (cylindrical
fuses)
00 (Knife fuses)



Catalogue Numbers

| Size | Current (A) | Catalogue Number | Voltage (V) | Unit Packing |
|-------|-------------|------------------|-------------|--------------|
| 10x38 | 15 | CA10D15 | 440V | 10 |
| 14x51 | 30 | CA14D30 | | |
| 22x58 | 15 | CA22D15 | | |
| | 30 | CA22D30 | | |
| | 45 | CA22D45 | | |
| 0 | 60 | CA22D60 | 440V | 3 |
| | 30 | 30NH00AD | | |
| | 45 | 45NH00AD | | |
| | 60 | 60NH00AD | | |
| | 90 | 90NH00AD | | |

Specifications

Description: fuse cartridge type AD for fitting to circuit breakers on low-voltage branch circuits.

Ratings:

- Volts: - 440V ac
- Amps: - 15 - 60A (Cylindrical fuses)
- 30 - 90A (Fuse size 00)
- IR - 20kA (size 10x38)
- 32kA (size 14x51, 22x58, 00)

Applications: Fitting for circuit breakers in public branch panels

Agency Information: Conform to standards NF C 62-921, EN IEC 60269

RoHS Compliant

Dimensions

| Sizes | A | B | C |
|-------|------|----|----|
| 10x38 | 10.3 | 38 | 10 |
| 14x51 | 14.3 | 51 | 13 |
| 22x58 | 22.2 | 58 | 16 |

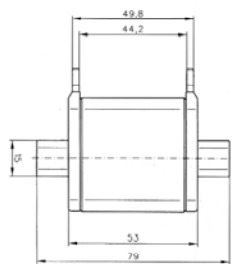
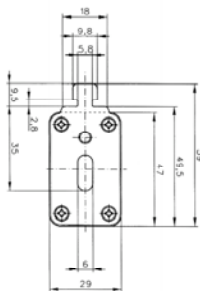

Cylindrical Industrial Fuses

Class gG
400 - 690V / 0.5 - 125A
Sizes: 8x31, 10x38,
14x51, 22x58



Specifications

Description: Cylindrical fuses for gG Industrial protection (general applications). Available with or without indicators and visual fuse activation indicator. Striker fitted to activate an auxiliary contact.

Ratings:

- Volts: - 400, 500, 690V ac
- Amps: - 0.25 - 125A
- IR - 20kA - 400V ac (size 8 x 31)
- 120kA - 400 and 500V ac
- 80 kA - 690V ac

Applications: Protection of electrical distribution circuits and electrical appliances (with the exception of electrical motors)

Agency Information: EN IEC 60269

RoHS Compliant

Dimensions

| Size | A | B | C | D | E |
|---------|------|------|-----|---|---|
| 8 x 31 | 8.5 | 31.5 | 6.3 | | |
| 10 x 38 | 10.3 | 38 | 10 | | |
| 14 x 51 | 14.3 | 51 | 13 | 8 | 4 |
| 22 x 58 | 22.2 | 58 | 16 | 8 | 4 |

Catalogue Numbers

| Size | Current (A) | References without Indicator | References with Indicator | References with Striker | Voltage (V) | Disconnection power (kA) | UP* | |
|---------|-------------|------------------------------|---------------------------|-------------------------|-------------|--------------------------|------|----|
| 8 x 31 | 0.5 | C08G0.5 | - | | 400V | 20kA | 10 | |
| | 1 | C08G1 | - | | | | | |
| | 2 | C08G2 | C08G2I | | | | | |
| | 4 | C08G4 | C08G4I | | | | | |
| | 6 | C08G4 | C08G4I | | | | | |
| | 8 | C08G8 | C08G8I | | | | | |
| | 10 | C08G10 | C08G10I | | | | | |
| | 12 | C08G12 | C08G12I | | | | | |
| | 16 | C08G16 | C08G16I | | | | | |
| 10 x 38 | 0.5 | C10G0.5 | - | | 500V | 120kA | 10 | |
| | 1 | C10G1 | - | | | | | |
| | 2 | C10G2 | C10G2I | | | | | |
| | 4 | C10G4 | C10G4I | | | | | |
| | 6 | C10G6 | C10G6I | | | | | |
| | 8 | C10G8 | C10G8I | | | | | |
| | 10 | C10G10 | C10G10I | | | | | |
| | 12 | C10G12 | C10G12I | | | | | |
| | 16 | C10G16 | C10G16I | | | | | |
| | 20 | C10G20 | C10G20I | | | | | |
| | 25 | C10G25 | C10G25I | | | | | |
| | 32 | C10G32 | C10G32I | | | | | |
| | 14 x 51 | 2 | C14G2 | C14G2I | C14G2S | 690V | 80kA | 10 |
| 4 | | C14G4 | C14G4I | C14G4S | | | | |
| 6 | | C14G6 | C14G6I | C14G6S | | | | |
| 8 | | C14G8 | C14G8I | C14G8S | | | | |
| 10 | | C14G10 | C14G10I | C14G10S | | | | |
| 12 | | C14G12 | C14G12I | C14G12S | | | | |
| 16 | | C14G16 | C14G16I | C14G16S | | | | |
| 20 | | C14G20 | C14G20I | C14G20S | | | | |
| 25 | | C14G25 | C14G25I | C14G25S | | | | |
| 32 | | C14G32 | C14G32I | C14G32S | | | | |
| 40 | | C14G40 | C14G40I | C14G40S | 500V | 120kA | | |
| 50 | | C14G50 | C14G50I | C14G50S | 400V | | | |
| | | | | | | | | |
| 22 x 58 | | 2 | C22G2 | C22G2I | | 690V | 80kA | 10 |
| | | 4 | C22G4 | C22G4I | C22G4S | | | |
| | 6 | C22G6 | C22G6I | C22G6S | | | | |
| | 8 | C22G8 | C22G8I | C22G8S | | | | |
| | 10 | C22G10 | C22G10I | C22G10S | | | | |
| | 12 | C22G12 | C22G12I | C22G12S | | | | |
| | 16 | C22G16 | C22G16I | C22G16S | | | | |
| | 20 | C22G20 | C22G20I | C22G20S | | | | |
| | 25 | C22G25 | C22G25I | C22G25S | | | | |
| | 32 | C22G32 | C22G32I | C22G32S | | | | |
| | 40 | C22G40 | C22G40I | C22G40S | | | | |
| | 50 | C22G50 | C22G50I | C22G50S | | | | |
| | 63 | C22G63 | C22G63I | C22G63S | | | | |
| | 80 | C22G80 | C22G80I | C22G80S | | | | |
| | 100 | C22G100 | C22G100I | C22G100S | 500V | 120kA | | |
| 125 | C22G125 | C22G125I | C22G125S | 400V | | | | |

*UP: Unit Packing

Cylindrical Industrial Fuses

Class aM

400 - 690V / 0.16 - 125A

Sizes: 8 x 31, 10 x 38,
14 x 51, 22 x 58



Specifications

Description: Cylindrical fuses for aM industrial protection range (protection of motors). Available in types without indicators, with visual fuse activation indicator and plunger for activation of an auxiliary contact.

Ratings:

- Volts: - 440, 500, 690V ac
- Amps: - 0.16 - 125A
- IR - 20kA - 400V ac (size 8 x 31)
- 120kA - 400 and 500V ac
- 80kA - 690Vac

Applications: Direct protection of motors

Agency information: Conform to standard EN IEC 60269

RoHS Compliant

Dimensions

| Size | A | B | C | D | E |
|---------|------|------|-----|---|---|
| 8 x 31 | 8.5 | 31.5 | 6.3 | | |
| 10 x 38 | 10.3 | 38 | 10 | | |
| 14 x 51 | 14.3 | 51 | 13 | 8 | 4 |
| 22 x 58 | 22.2 | 58 | 16 | 8 | 4 |

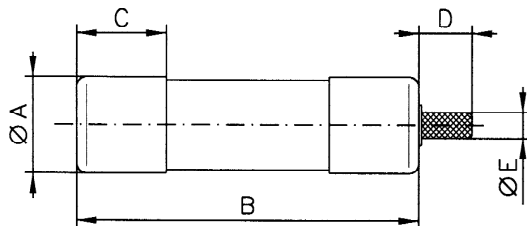

Catalogue Numbers

| Size | Current (A) | References without Indicator | References with Indicator | References with striker | Voltage (V) | Disconnection power (kA) | UP* | | | |
|---------|-------------|------------------------------|---------------------------|-------------------------|-------------|--------------------------|---------|------|------|----|
| 8 x 31 | 1 | C8M1 | C8M1I | N/A | 400V | 20kA | 10 | | | |
| | 2 | C8M2 | C8M2I | | | | | | | |
| | 4 | C8M4 | C8M4I | | | | | | | |
| | 6 | C8M6 | C8M6I | | | | | | | |
| | 10 | C8M10 | C8M10I | | | | | | | |
| 10 x 38 | 0.16 | C10M0.16 | - | N/A | 500V | 120kA | 10 | | | |
| | 0.25 | C10M0.25 | - | | | | | | | |
| | 0.5 | C10M0.5 | - | | | | | | | |
| | 1 | C10M1 | C10M1I | | | | | | | |
| | 2 | C10M2 | C10M2I | | | | | | | |
| | 4 | C10M4 | C10M4I | | | | | | | |
| | 6 | C10M6 | C10M6I | | | | | | | |
| | 8 | C10M8 | C10M8I | | | | | | | |
| | 10 | C10M10 | C10M10I | | | | | | | |
| | 12 | C10M12 | C10M12I | | | | | | | |
| | 16 | C10M16 | C10M16I | | | | | | | |
| | 20 | C10M20 | C10M20I | | | | | | | |
| | 25 | C10M25 | C10M25I | | | | | | | |
| 32 | C10M32 | - | 400V | | | | | | | |
| 14 x 51 | 0.25 | C14M0.25 | | 500V | 120kA | 10 | | | | |
| | 0.5 | C14M0.50 | | | | | | | | |
| | 1 | C14M1 | C14M1I | | | | | | | |
| | 2 | C14M2 | C14M2I | | | | C14M2S | | | |
| | 4 | C14M4 | C14M4I | | | | C14M4S | | | |
| | 6 | C14M6 | C14M6I | | | | C14M6S | | | |
| | 8 | C14M8 | C14M8I | | | | C14M8S | | | |
| | 10 | C14M10 | C14M10I | | | | C14M10S | | | |
| | 12 | C14M12 | C14M12I | | | | C14M12S | | | |
| | 16 | C14M16 | C14M16I | | | | C14M16S | | | |
| | 20 | C14M20 | C14M20I | | | | C14M20S | | | |
| | 25 | C14M25 | C14M25I | | | | C14M25S | | | |
| | 32 | C14M32 | C14M32I | | | | C14M32S | | | |
| | 40 | C14M40 | C14M40I | | | | C14M40S | | | |
| | 50 | C14M50 | C14M50I | | | | C14M50S | 400V | | |
| | 22 x 58 | 2 | C22M2 | | | | C22M2I | 690V | 80kA | 10 |
| | | 4 | C22M4 | | | | C22M4I | | | |
| 6 | | C22M6 | C22M6I | | | | | | | |
| 8 | | C22M8 | C22M8I | | | | | | | |
| 10 | | C22M10 | C22M10I | | | | | | | |
| 12 | | C22M12 | C22M12I | | | | | | | |
| 16 | | C22M16 | C22M16I | C22M16S | | | | | | |
| 20 | | C22M20 | C22M20I | C22M20S | | | | | | |
| 25 | | C22M25 | C22M25I | C22M25S | | | | | | |
| 32 | | C22M32 | C22M32I | C22M32S | | | | | | |
| 40 | | C22M40 | C22M40I | C22M40S | | | | | | |
| 50 | | C22M50 | C22M50I | C22M50S | | | | | | |
| 63 | | C22M63 | C22M63I | C22M63S | | | | | | |
| 80 | | C22M80 | C22M80I | C22M80S | | | | | | |
| 100 | | C22M100 | C22M100I | C22M100S | 500V | | | | | |
| 125 | C22M125 | C22M125I | C22M125S | 400V | 120kA | | | | | |

*UP: Unit Packing

Neutral Cartridges

| | | |
|---------|---------|-------|
| 8 x 31 | Neutral | C8NL |
| 10 x 38 | | C10NL |
| 14 x 51 | | C14NL |
| 22 x 58 | | C22NL |

Modular Domestic Fuse Holders

CHD
250 - 400V / 10 - 32A
Sizes: 8x23, 10x25, 8x31
10x31, 10x38



Catalogue Numbers



| Size | Rating (A) | Voltage (V) | Single Pole | | Single Pole + Neutral | | UP |
|---------|------------|-------------|-------------------|----------------|-----------------------|----------------|----|
| | | | without Indicator | with Indicator | without Indicator | with Indicator | |
| 8x23 | 10 | 250 | CHD8231D | CHD8231DI | CHD8231DN | CHD8231DNI | 12 |
| 10x25 | 16 | 250 | CHD10251D | CHD10251DI | CHD10251DN | CHD10251DNI | 12 |
| 8x31 | 20 | 400 | CHD8311D | CHD8311DI | CHD8311DN | CHD8311DNI | 12 |
| 10x31 | 25 | 400 | CHD10311D | CHD10311DI | CHD10311DN | CHD10311DNI | 12 |
| 10x38 | 32 | 400 | CHD1038D | CHD1038DI | CHD1038DN | CHD1038DNI | 12 |
| Neutral | 32 | 400 | CHDND | - | - | - | 12 |

UP: Unit Packing

Specifications

Description: Fuse Holder for domestic cylindrical fuses. Secured to DIN rail and available with light indicator for active fuse function. Range as single-pole and single-pole plus neutral in one module.

Ratings:

- Volts: - 250V ac (8x31, 10x25)
- 400V ac (8x31, 10x31, 10x38)
- Amps: - 10 - 32A
- IR - 6kA (6x23, 8x23, 10x25)
- 20kA (8x31, 10x31, 8x36, 10x38)

Applications: Protection for power lines, heating circuits, lighting circuits. electrical domestic appliances and domestic electricity meters

Agency Information: NF C 62203, EN IEC 60269-3, NF marking on all models

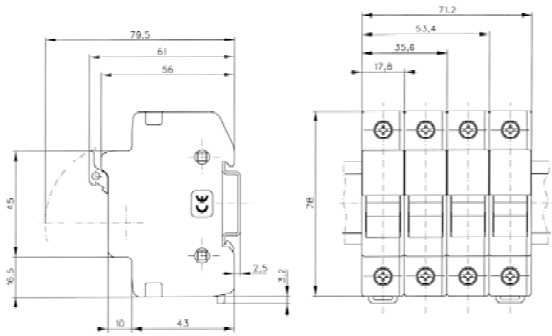

Cylindrical Industrial Fuses

CHM
690V / 25 - 32A
Sizes: 8x31, 10x38



Specifications

Description: Fuse Holder for cylindrical industrial fuses. Secured to DIN rail and available with and without light indicator for active fuse function. Range as multi-pole and single-pole plus neutral fuse holders in one module. Accessories for the assembly of modules.

Ratings:

Volts: - 690V ac
 Amps: - 25 - 32A

Applications: Protection of industrial electrical distribution circuits and electrical appliances

Agency Information: EN IEC 60269-3, EN IEC 60947

Dimensions

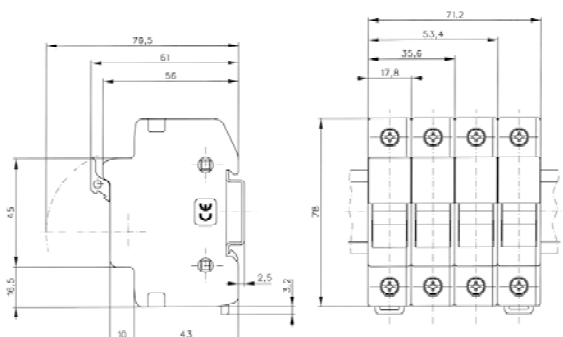

Catalogue Numbers

| Size | Poles | No of Modules | References without Indicator | References with Indicator | Current (A) | Voltage (V) | Unit Packing |
|---------|---------|---------------|------------------------------|---------------------------|-------------|-------------|--------------|
| 8 x 31 | Neutral | 1 | CHMDNX | - | 25A | 690V | 12 |
| | 1P | 1 | CH081D | CH081DI | | | 12 |
| | 1P + N | 1 | CH081DNS | CH081DNSI | | | 12 |
| | 1P + N | 2 | CH081DN | CH081DNI | | | 6 |
| | 2P | 2 | CH082D | CH082DI | | | 6 |
| | 3P | 3 | CH083D | CH083DI | | | 4 |
| | 3P + N | 3 | CH083DNS | CH083DNSI | | | 4 |
| | 3P + N | 4 | CH083DN | CH083DNI | | | 3 |
| 10 x 38 | Neutral | 1 | CHMDNX | - | 32A | 690V | 12 |
| | 1P | 1 | CHM1D | CHM1DI | | | 12 |
| | 1P + N | 1 | CHM1DNS | CHM1DNSI | | | 12 |
| | 1P + N | 2 | CHM1DN | CHM1DNI | | | 6 |
| | 2P | 2 | CHM2D | CHM2DI | | | 6 |
| | 3P | 3 | CHM3D | CHM3DI | | | 4 |
| | 3P + N | 3 | CHM3DNS | CHM3DNSI | | | 4 |
| | 3P + N | 4 | CHM3DN | CHM3DNI | | | 3 |
| | 4P | 4 | CHM4D | CHM4DI | 3 | | |

Catalogue Number

| Description | Size | References | Unit Packing |
|---|--------------------------------------|------------|--------------|
| Clips for assembly of multi-pole fuse holders | 8 x 31 - 10 x 38 - 14 x 51 - 22 x 58 | AL-D | 12 |
| Multi phase handle pin connector | 8 x 31 - 10 x 38 | CH810-HP | 12 |

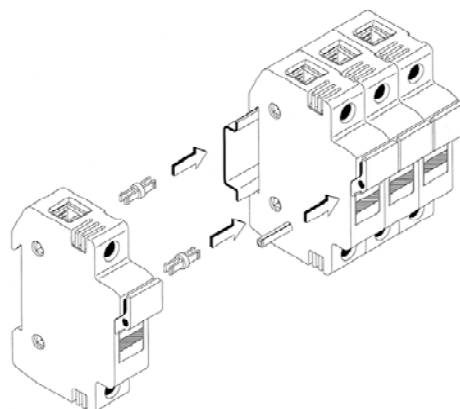

Cylindrical Industrial Fuses

CH
690V / 50 - 125A
Sizes: 14 x 51, 22 x 38



Specifications

Description: Fuse Holders for cylindrical industrial fuses. Secured to DIN rail and screwed. Available with and without light indicator for active fuse function and with auxiliary contact for use with plunger fuses. The auxiliary contact is available in two versions: one for the detection of fuse actuation and pre-disconnected, and the other fuse actuation only.

Ratings:

Volts: - 690V ac
 Amps: - 25 - 32A

Applications: Protection of industrial circuits and electrical appliances.

Agency Information: EN IEC 60269-3, EN IEC 60947

Dimensions

14 x 51

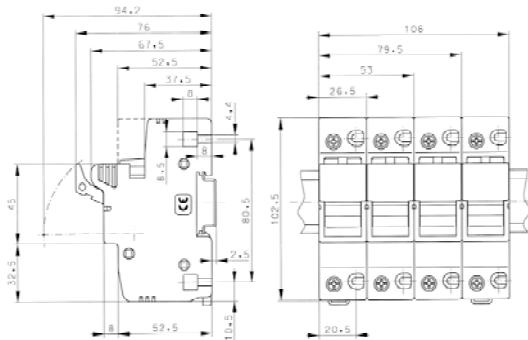

22 x 58

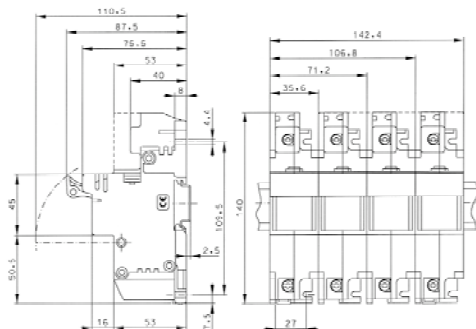

Catalogue Numbers

| Size | Poles | Nb of Modules | References without Indicator | References with Indicator | References with auxiliary contact | | Current (A) | Voltage (V) | UP* |
|---------|---------|---------------|------------------------------|---------------------------|---|---------------|-------------|-------------|-----|
| | | | | | Fuse response/presence and pre-disconnect | Fuse response | | | |
| 14 x 51 | Neutral | 1.5 | CH141DNX | | - | - | 50A | 690V | 6 |
| | 1P | 1.5 | CH141D | CH141DI | CH141DMS-F | CH141DMS | | | 6 |
| | 1P + N | 3 | CH141DN | CH141DNI | - | - | | | 3 |
| | 2P | 3 | CH142D | CH142DI | - | - | | | 2 |
| | 3P | 4.5 | CH143D | CH143DI | CH143DMS-F | CH143DMS | | | 2 |
| | 3P + N | 6 | CH143DN | CH143DNI | CH143DNMS-F | CH143DNMS | | | 1 |
| 22 x 58 | Neutral | 2 | CH221DNX | | - | - | 125A | 690V | 6 |
| | 1P | 2 | CH221D | | - | CH221DMS | | | 6 |
| | 1P + N | 4 | CH221DN | | - | - | | | 3 |
| | 2P | 4 | CH222D | | - | - | | | 3 |
| | 3P | 6 | CH223D | | - | CH223DMS | | | 2 |
| | 3P + N | 8 | CH223DN | | - | CH223DNMS | | | 1 |
| | 4P | 8 | CH224D | | - | - | 1 | | |

*UP: Unit Packing

Catalogue Numbers

| Description | Size | Ref | UP* |
|--|---------------------|-----------|-----|
| Clips for assembly of multi-pole fuse holder | 8x31, 10x38, 14x51, | AL-D | 12 |
| Multi phase handle Pin connector | 14x51 | CH14-P | 12 |
| Auxiliary contact for fuse response - 1 pole | 14x51 | CH14MS-1D | 5 |
| Auxiliary contact for fuse response - 3 pole | 14x51 | CH14MS-3D | 2 |

*UP: Unit Packing

NH Fuses - Dual Indicator

**Class gG - Low Power Loss
400V / 2 - 630A**

**Sizes 000, 00, 01, 1, 02, 2,
03, 3**

Specifications

Description: Low Power Loss NH Fuses for industrial protection, gG range (general protection). Dual Indicator system for fuse operation function (in the body and in the side plate). Version with voltage free metal gripping lugs for insulated fuses. The components used are lead and cadmium free. Fuses subject to HRC recycling commitment.

Ratings:

Volts: - 400V ac
Amps: - 2 - 630A
IR - 120kA - 400V ac

Applications: Protection of large electric distribution networks, cables and distribution boards where the minimization of power losses is a requirement. Electrical utilities and electrical distribution networks

Standards and Approvals: Conform to standards EN IEC 60269, VDE 0636, DIN 43620, VDE approval.

Dimensions: see page 35



Catalogue Numbers

| Size | Rated Current (A) | gG-gL Dual Indicator | | Unit Packing |
|------|-------------------|----------------------------------|----------------------------------|--------------|
| | | voltage conducting gripping lugs | voltage free metal gripping lugs | |
| 000 | 2 | 2NHG000B-400 | 2NHG000BI-400 | 3 |
| | 4 | 4NHG000B-400 | 4NHG000BI-400 | 3 |
| | 6 | 6NHG000B-400 | 6NHG000BI-400 | 3 |
| | 10 | 10NHG000B-400 | 10NHG000BI-400 | 3 |
| | 16 | 16NHG000B-400 | 16NHG000BI-400 | 3 |
| | 20 | 20NHG000B-400 | 20NHG000BI-400 | 3 |
| | 25 | 25NHG000B-400 | 25NHG000BI-400 | 3 |
| | 32 | 32NHG000B-400 | 32NHG000BI-400 | 3 |
| | 35 | 35NHG000B-400 | 35NHG000BI-400 | 3 |
| | 40 | 40NHG000B-400 | 40NHG000BI-400 | 3 |
| | 50 | 50NHG000B-400 | 50NHG000BI-400 | 3 |
| | 63 | 63NHG000B-400 | 63NHG000BI-400 | 3 |
| | 80 | 80NHG000B-400 | 80NHG000BI-400 | 3 |
| 00 | 100 | 100NHG000B-400 | 100NHG000BI-400 | 3 |
| | 125 | 125NHG000B-400 | 125NHG000BI-400 | 3 |
| 01 | 160 | 160NHG000B-400 | 160NHG000BI-400 | 3 |
| | 35 | 35NHG01B-400 | 35NHG01BI-400 | 3 |
| | 40 | 40NHG01B-400 | 40NHG01BI-400 | 3 |
| | 50 | 50NHG01B-400 | 50NHG01BI-400 | 3 |
| | 63 | 63NHG01B-400 | 63NHG01BI-400 | 3 |
| | 80 | 80NHG01B-400 | 80NHG01BI-400 | 3 |
| | 100 | 100NHG01B-400 | 100NHG01BI-400 | 3 |
| 1 | 125 | 125NHG01B-400 | 125NHG01BI-400 | 3 |
| | 160 | 160NHG01B-400 | 160NHG01BI-400 | 3 |
| | 200 | 200NHG1B-400 | 200NHG1BI-400 | 3 |
| | 224 | 224NHG1B-400 | 224NHG1BI-400 | 3 |
| 02 | 250 | 250NHG1B-400 | 250NHG1BI-400 | 3 |
| | 35 | 35NHG02B-400 | 35NHG02BI-400 | 3 |
| | 40 | 40NHG02B-400 | 40NHG02BI-400 | 3 |
| | 50 | 50NHG02B-400 | 50NHG02BI-400 | 3 |
| | 63 | 63NHG02B-400 | 63NHG02BI-400 | 3 |
| | 80 | 80NHG02B-400 | 80NHG02BI-400 | 3 |
| | 100 | 100NHG02B-400 | 100NHG02BI-400 | 3 |
| | 125 | 125NHG02B-400 | 125NHG02BI-400 | 3 |
| | 160 | 160NHG02B-400 | 160NHG02BI-400 | 3 |
| | 200 | 200NHG02B-400 | 200NHG02BI-400 | 3 |
| | 224 | 224NHG02B-400 | 224NHG02BI-400 | 3 |
| 2 | 250 | 250NHG02B-400 | 250NHG02BI-400 | 3 |
| | 315 | 315NHG2B-400 | 315NHG2BI-400 | 3 |
| | 355 | 355NHG2B-400 | 355NHG2BI-400 | 3 |
| 03 | 400 | 400NHG2B-400 | 400NHG2BI-400 | 3 |
| | 250 | 250NHG03B-400 | 250NHG03BI-400 | 3 |
| | 315 | 315NHG03B-400 | 315NHG03BI-400 | 3 |
| | 355 | 355NHG03B-400 | 355NHG03BI-400 | 3 |
| 3 | 400 | 400NHG03B-400 | 400NHG03BI-400 | 3 |
| | 500 | 500NHG3B-400 | 500NHG3BI-400 | 3 |
| | 630 | 630NHG3B-400 | 630NHG3BI-400 | 3 |

Data Sheets: 720097 / 720099

NH Fuses - Dual Indicator

Class gG - Low Power Loss 500V / 2 - 1600A

Sizes C00, 0, 1, 2, 3, 4, 4A

Specifications

Description: Low Power Loss NH Fuses for industrial protection, gG range (general protection). Dual Indicator system for fuse operation function (in the body and in the side plate) except for the sizes 4 & 4A. Version with voltage free metal gripping lugs for insulated fuses. The components used in manufacture are lead and cadmium free. Fuses subject to HRC recycling commitment.

Ratings:

- Volts: - 500V ac
- Amps: - 2 - 1600A
- IR - 120kA - 500V ac
- 50kA - 250V dc

Applications: Protection of large electric distribution networks, cables and distribution boards (except motors) where the minimize of power losses is a requirement.

Standards and Approvals: Conform to standards EN IEC 60269, VDE 0636, DIN 43620, VDE approval.

Dimensions: see page 35



Catalogue Numbers

| Size | Rated Current (A) | gG-gL Dual Indicator | | Unit Packing |
|-----------------------|-------------------|----------------------------------|----------------------------------|--------------|
| | | voltage conducting gripping lugs | voltage free metal gripping lugs | |
| 000 | 2 | 2NHG000B | 2NHG000BI | 3 |
| | 4 | 4NHG000B | 4NHG000BI | 3 |
| | 6 | 6NHG000B | 6NHG000BI | 3 |
| | 10 | 10NHG000B | 10NHG000BI | 3 |
| | 16 | 16NHG000B | 16NHG000BI | 3 |
| | 20 | 20NHG000B | 20NHG000BI | 3 |
| | 25 | 25NHG000B | 25NHG000BI | 3 |
| | 32 | 32NHG000B | 32NHG000BI | 3 |
| | 35 | 35NHG000B | 35NHG000BI | 3 |
| | 40 | 40NHG000B | 40NHG000BI | 3 |
| 0 | 50 | 50NHG000B | 50NHG000BI | 3 |
| | 63 | 63NHG000B | 63NHG000BI | 3 |
| | 80 | 80NHG000B | 80NHG000BI | 3 |
| | 100 | 100NHG000B | 100NHG000BI | 3 |
| | 125 | 125NHG000B | 125NHG000BI | 3 |
| | 160 | 160NHG000B | 160NHG000BI | 3 |
| | 10 | 10NHG00B | - | 3 |
| | 16 | 16NHG00B | - | 3 |
| | 20 | 20NHG00B | - | 3 |
| | 25 | 25NHG00B | - | 3 |
| 01 | 32 | 32NHG00B | - | 3 |
| | 35 | 35NHG00B | - | 3 |
| | 40 | 40NHG00B | - | 3 |
| | 50 | 50NHG00B | - | 3 |
| | 63 | 63NHG00B | - | 3 |
| | 80 | 80NHG00B | - | 3 |
| | 100 | 100NHG00B | - | 3 |
| | 125 | 125NHG00B | - | 3 |
| | 160 | 160NHG00B | - | 3 |
| | 1 | 10 | 10NHG01B | 10NHG01BI |
| 16 | | 16NHG01B | 16NHG01BI | 3 |
| 20 | | 20NHG01B | 20NHG01BI | 3 |
| 25 | | 25NHG01B | 25NHG01BI | 3 |
| 32 | | 32NHG01B | 32NHG01BI | 3 |
| 35 | | 35NHG01B | 35NHG01BI | 3 |
| 40 | | 40NHG01B | 40NHG01BI | 3 |
| 50 | | 50NHG01B | 50NHG01BI | 3 |
| 63 | | 63NHG01B | 63NHG01BI | 3 |
| 80 | | 80NHG01B | 80NHG01BI | 3 |
| 2 | 100 | 100NHG01B | 100NHG01BI | 3 |
| | 125 | 125NHG01B | 125NHG01BI | 3 |
| | 160 | 160NHG01B | 160NHG01BI | 3 |
| 02 | 200 | 200NHG1B | 200NHG1BI | 3 |
| | 224 | 224NHG1B | 224NHG1BI | 3 |
| | 250 | 250NHG1B | 250NHG1BI | 3 |
| 03 | 35 | 35NHG02B | 35NHG02BI | 3 |
| | 40 | 40NHG02B | 40NHG02BI | 3 |
| | 50 | 50NHG02B | 50NHG02BI | 3 |
| | 63 | 63NHG02B | 63NHG02BI | 3 |
| | 80 | 80NHG02B | 80NHG02BI | 3 |
| | 100 | 100NHG02B | 100NHG02BI | 3 |
| | 125 | 125NHG02B | 125NHG02BI | 3 |
| | 160 | 160NHG02B | 160NHG02BI | 3 |
| | 200 | 200NHG02B | 200NHG02BI | 3 |
| | 224 | 224NHG02B | 224NHG02BI | 3 |
| 2 | 250 | 250NHG02B | 250NHG02BI | 3 |
| | 315 | 315NHG2B | 315NHG2BI | 3 |
| | 355 | 355NHG2B | 355NHG2BI | 3 |
| 3 | 400 | 400NHG2B | 400NHG2BI | 3 |
| | 250 | 250NHG03B | 250NHG03BI | 3 |
| | 315 | 315NHG03B | 315NHG03BI | 3 |
| 4 | 355 | 355NHG03B | 355NHG03BI | 3 |
| | 400 | 400NHG03B | 400NHG03BI | 3 |
| | 500 | 500NHG3B | 500NHG3BI | 3 |
| 4A | 630 | 630NHG3B | 630NHG3BI | 3 |
| | 500 | 500NHG4G | - | 3 |
| | 630 | 630NHG4G | - | 3 |
| | 800 | 800NHG4G | - | 3 |
| | 1000 | 1000NHG4G | - | 3 |
| None Slotted End Tags | 1250 | 1250NHG4G | - | 3 |
| | 630 | 630NH4AG | - | 3 |
| | 800 | 800NH4AG | - | 3 |
| | 900 | 900NH4AG | - | 3 |
| | 1000 | 1000NH4AG | - | 3 |
| None Slotted End Tags | 1250 | 1250NH4AG | - | 3 |
| | 1600 | 1600NH4AG | - | 3 |

Data Sheets: 2142

NH Fuses - Dual Indicator

Class gG
690V / 2 - 630A

Sizes 000, 00, 0, 1, 2, 3

Specifications

Description: NH Fuses for gG range industrial protection (general protection). Double indicator system for fuse operation (in the body and in the side plate). Version with voltage free metal gripping lugs for insulated fuses. The components used in manufacture are lead and cadmium free. Fuses subject to HRC recycling commitment.

Ratings:

Volts: - 690V ac
Amps: - 2 - 630A
IR - 120kA - 690V ac

Applications: Protection of electrical distribution circuits, cables and electrical appliances (with the exception of motors).

Standards and Approvals: Conform to standards EN IEC 60269, VDE 0636, DIN 43620.

Dimensions: see page 35



Catalogue Numbers

| Size | Rated Current (A) | gG - gL Dual Indicator | | Unit Packing | | |
|------|-------------------|----------------------------------|----------------------------------|--------------|--------------|---|
| | | voltage conducting gripping lugs | voltage free metal gripping lugs | | | |
| 000 | 2 | 2NHG000B-690 | 2NHG000BI-690 | 3 | | |
| | 4 | 4NHG000B-690 | 4NHG000BI-690 | | | |
| | 6 | 6NHG000B-690 | 6NHG000BI-690 | | | |
| | 10 | 10NHG000B-690 | 10NHG000BI-690 | | | |
| | 16 | 16NHG000B-690 | 16NHG000BI-690 | | | |
| | 20 | 20NHG000B-690 | 20NHG000BI-690 | | | |
| | 25 | 25NHG000B-690 | 25NHG000BI-690 | | | |
| | 32 | 32NHG000B-690 | 32NHG000BI-690 | | | |
| | 35** | 35NHG000B-690 | 35NHG000BI-690 | | | |
| 00 | 40 | 40NHG000B-690 | 40NHG000BI-690 | 3 | | |
| | 50 | 50NHG00B-690 | 50NHG00BI-690 | | | |
| | 63 | 63NHG00B-690 | 63NHG00BI-690 | | | |
| | 80 | 80NHG00B-690 | 80NHG00BI-690 | | | |
| 0 | 100 | 100NHG00B-690 | 100NHG00BI-690 | 3 | | |
| | 6 | 6NHG0B-690 | - | | | |
| | 10 | 10NHG0B-690 | - | | | |
| | 16 | 16NHG0B-690 | - | | | |
| | 20 | 20NHG0B-690 | - | | | |
| | 25 | 25NHG0B-690 | - | | | |
| | 32 | 32NHG0B-690 | - | | | |
| | 35 | 35NHG0B-690 | - | | | |
| | 40 | 40NHG0B-690 | - | | | |
| | 50 | 50NHG0B-690 | - | | | |
| 1 | 63 | 63NHG0B-690 | - | 3 | | |
| | 80 | 80NHG0B-690 | - | | | |
| | 100 | 100NHG0B-690 | - | | | |
| | 125 | 125NHG0B-690 | - | | | |
| | 160 | 160NHG0B-690 | - | | | |
| | 200 | 200NHG0B-690 | - | | | |
| | 63 | 63NHG1B-690 | 63NHG1BI-690 | | | |
| | 80 | 80NHG1B-690 | 80NHG1BI-690 | | | |
| | 100 | 100NHG1B-690 | 100NHG1BI-690 | | | |
| | 125 | 125NHG1B-690 | 125NHG1BI-690 | | | |
| | 160 | 160NHG1B-690 | 160NHG1BI-690 | | | |
| | 200 | 200NHG1B-690 | 200NHG1BI-690 | | | |
| | 2 | 63 | 63NHG2B-690 | | 63NHG2BI-690 | 3 |
| | | 80 | 80NHG2B-690 | | 80NHG2BI-690 | |
| 100 | | 100NHG2B-690 | 100NHG2BI-690 | | | |
| 125 | | 125NHG2B-690 | 125NHG2BI-690 | | | |
| 160 | | 160NHG2B-690 | 160NHG2BI-690 | | | |
| 200 | | 200NHG2B-690 | 200NHG2BI-690 | | | |
| 224 | | 224NHG2B-690 | 224NHG2BI-690 | | | |
| 3 | 250 | 250NHG2B-690 | 250NHG2BI-690 | 3 | | |
| | 315 | 315NHG2B-690 | 315NHG2BI-690 | | | |
| | 250 | 250NHG3B-690 | 250NHG3BI-690* | | | |
| | 315 | 315NHG3B-690 | 315NHG3BI-690* | | | |
| | 355 | 355NHG3B-690 | 355NHG3BI-690* | | | |
| | 400 | 400NHG3B-690 | 400NHG3BI-690* | | | |
| 3 | 500 | 500NHG3B-690 | 500NHG3BI-690* | 3 | | |
| | 630 | - | - | | | |

* Contact Cooper Bussmann for availability

** Interrupting Rating for the 35 A size 000 is 80kA

NH Fuses - Dual Indicator

Class aM
500 - 690V / 2 - 630A

Sizes 000, 00, 0, 1, 2, 3A



Specifications

Description: NH Fuses for aM range industrial protection (general protection). Double indicator system for fuse operation (in the body and in the side plate). Version with voltage free metal gripping lugs for insulated fuses.
The components used in manufacture are lead and cadmium free. Fuses subject to HRC recycling commitment.

Ratings:

- Volts: - 690V ac
- Amps: - 25 - 32A
- IR - 80 kA - 500Vac (sizes 000,00 - up to 100A)
- 120kA - 500Vac/690Vac

Applications: Protection of electrical motors.

Standards and Approvals: Conform to standards EN IEC 60269, VDE 0636, DIN 43620.

Dimensions: see page 35

Catalogue Numbers

| Size | Rated Current (A) | aM Dual Indicator | | Unit Packing |
|------|-------------------|----------------------------------|----------------------------------|--------------|
| | | voltage conducting gripping lugs | voltage free metal gripping lugs | |
| 000 | 2 | - | - | 3 |
| | 4 | - | - | |
| | 6 | 6NHM000B-690 | 6NHM000BI-690 | |
| | 10 | 10NHM000B-690 | 10NHM000BI-690 | |
| | 16 | 16NHM000B-690 | 16NHM000BI-690 | |
| | 20 | 20NHM000B-690 | 20NHM000BI-690 | |
| | 25 | 25NHM000B-690 | 25NHM000BI-690 | |
| | 32 | 32NHM000B-690 | 32NHM000BI-690 | |
| 00 | 35 | 35NHM000B-690 | 35NHM000BI-690 | 3 |
| | 40 | 40NHM000B-690 | 40NHM000BI-690 | |
| | 50 | 50NHM00B | 50NHM00BI | |
| | 63 | 63NHM00B | 63NHM00BI | |
| | 80 | 80NHM00B | 80NHM00BI | |
| 0 | 100 | 100NHM00B | 100NHM00BI | 3 |
| | 160 | 160NHM00B | 160NHM00BI | |
| | 6 | 6NHM0B | - | |
| | 10 | 10NHM0B | - | |
| | 16 | 16NHM0B | - | |
| | 20 | 20NHM0B | - | |
| | 25 | 25NHM0B | - | |
| | 32 | 32NHM0B | - | |
| | 35 | 35NHM0B | - | |
| | 40 | 40NHM0B | - | |
| 1 | 50 | 50NHM0B | - | 3 |
| | 63 | 63NHM0B | - | |
| | 80 | 80NHM0B | - | |
| | 100 | 100NHM0B | - | |
| | 125 | 125NHM1B | 125NHM1BI | |
| | 160 | 160NHM1B | 160NHM1BI | |
| | 200 | 200NHM1B | 200NHM1BI | |
| | 224 | 224NHM1B | 224NHM1BI | |
| 2 | 250 | 250NHM1B | 250NHM1BI | 3 |
| | 63 | - | - | |
| | 80 | - | - | |
| | 100 | - | - | |
| | 125 | 125NHM2B-690 | 125NHM2BI-690 | |
| | 160 | 160NHM2B-690 | 160NHM2BI-690 | |
| | 200 | 200NHM2B-690 | 200NHM2BI-690 | |
| | 224 | 224NHM2B-690 | 224NHM2BI-690 | |
| | 250 | 250NHM2B-690 | 250NHM2BI-690 | |
| 3 | 315 | 315NHM2B-690 | 315NHM2BI-690 | 3 |
| | 355 | 355NHM2B-690 | 355NHM2BI-690 | |
| | 400 | 400NHM2B | 400NHM2BI | |
| | 250 | - | - | |
| | 315 | 315NHM3B-690 | 315NHM3BI-690 | |
| | 355 | 355NHM3B-690 | 355NHM3BI-690 | |
| 3 | 400 | 400NHM3B-690 | 400NHM3BI-690 | 3 |
| | 500 | 500NHM3B-690 | 500NHM3BI-690 | |
| | 630 | 630NHM3B | 630NHM3BI | |

NH Fuses

Class aM
500V / 2 - 630A

Sizes C00, 0, 1, 2, 3



Specifications

Description: NH Fuses for aM range industrial protection (general protection). Indicator for fuse activation in the side panel. The components used in manufacture are lead and cadmium free. Fuses subject to HRC recycling commitment.

Ratings:

- Volts: - 500V ac
- Amps: - 2 - 630A
- IR - 120kA - 500Vac
- 50kA - 250V dc

Applications: Protection of direct starter motors

Standards and Approvals: Conform to standards EN IEC 60269, VDE 0636, DIN 43620.

Dimensions: see page 35

Catalogue Numbers

| Size | Rated current (A) | Voltage conducting gripping lugs | Disconnect Power (kA) | Unit Packing |
|------|-------------------|----------------------------------|-----------------------|--------------|
| C00 | 2 | 2NHC00M | 120kA | 3 |
| | 4 | 4NHC00M | | |
| | 6 | 6NHC00M | | |
| | 10 | 10NHC00M | | |
| | 16 | 16NHC00M | | |
| | 20 | 20NHC00M | | |
| | 25 | 25NHC00M | | |
| | 32 | 32NHC00M | | |
| | 40 | 40NHC00M | | |
| 00 | 50 | 50NHC00M | 120kA | 3 |
| | 63 | 63NH00M | | |
| | 80 | 80NH00M | | |
| | 100 | 100NH00M | | |
| | 125 | 125NH00M | | |
| 0 | 160 | 160NH00M | 120kA | 3 |
| | 32 | 32NH0M | | |
| | 50 | 50NH0M | | |
| | 63 | 63NH0M | | |
| | 80 | 80NH0M | | |
| | 100 | 100NH0M | | |
| 1 | 125 | 125NH0M | 120kA | 3 |
| | 160 | 160NH0M | | |
| | 40 | 40NH1M | | |
| | 50 | 50NH1M | | |
| | 63 | 63NH1M | | |
| | 80 | 80NH1M | | |
| | 100 | 100NH1M | | |
| 2 | 125 | 125NH1M | 120kA | 3 |
| | 160 | 160NH1M | | |
| | 200 | 200NH1M | | |
| | 250 | 250NH1M | | |
| | 100 | 100NH2M | | |
| | 125 | 125NH2M | | |
| | 160 | 160NH2M | | |
| 3 | 200 | 200NH2M | 120kA | 3 |
| | 250 | 250NH2M | | |
| | 315 | 315NH2M | | |
| | 355 | 355NH2M | | |
| | 400 | 400NH2M | | |
| 3 | 315 | 315NH3M | 120kA | 3 |
| | 400 | 400NH3M | | |
| | 500 | 500NH3M | | |
| | 630 | 630NH3M | | |

NH Fuses with Striker

Class gG - aM
500 - 690V / 63 - 1250A

Sizes 1, 2, 3, 4



Specifications

Description: NH Fuses for industrial applications class gG and aM with integrated side striker for visual or remote indication of the fuse status. To be used with NH fuse holders fitted with micro-switch.

Ratings:

- Volts: - 500V ac Size 4
 - 690V ac Size 1,2,3
 Current - 63A - 1250A
 IR - 120kA - 500V ac
 - 80kA - 690V ac

Applications: Protection of electrical distribution circuits (Class gG) and motor protection (Class aM)

Standards and Approvals: Conform to standards EN IEC 60269, VDE 0636, DIN 43620.

Catalogue Numbers

| Size | Rated Current (A) | gG | aM | Pack Qty |
|------|-------------------|--|--|----------|
| | | Voltage conducting metal gripping lugs | Voltage conducting metal gripping lugs | |
| 1 | 63 | 63NHG1BS-690* | 63NHM1BS-690* | 3 |
| | 80 | 80NHG1BS-690* | 80NHM1BS-690* | |
| | 100 | 100NHG1BS-690* | 100NHM1BS-690* | |
| | 125 | 125NHG1BS-690* | 125NHM1BS-690* | |
| | 160 | 160NHG1BS-690* | 160NHM1BS-690* | |
| | 200 | 200NHG1BS-690* | 200NHM1BS-690* | |
| | 224 | - | 224NHM1BS-690* | |
| 250 | - | 250NHM1BS-690* | | |
| 2 | 125 | 125NHG2BS-690* | 125NHM2BS-690* | 3 |
| | 160 | 160NHG2BS-690* | 160NHM2BS-690* | |
| | 200 | 200NHG2BS-690* | 200NHM2BS-690* | |
| | 224 | 224NHG2BS-690* | 224NHM2BS-690* | |
| | 250 | 250NHG2BS-690* | 250NHM2BS-690* | |
| | 315 | 315NHG2BS-690* | 315NHM2BS-690* | |
| | 355 | - | 355NHM2BS-690* | |
| 400 | - | 400NHM2BS-690* | | |
| 3 | 315 | 315NHG3BS-690* | - | 3 |
| | 355 | 355NHG3BS-690* | - | |
| | 400 | 400NHG3BS-690* | 400NHM3BS-690* | |
| | 500 | 500NHG3BS-690* | 500NHM3BS-690* | |
| | 630 | 630NHG3BS-690* | 630NHM3BS-690* | |
| 4 | 500 | 500NH4G-S | - | 3 |
| | 630 | 630NH4G-S | - | |
| | 800 | 800NH4G-S | - | |
| | 1000 | 1000NH4G-S | - | |
| | 1250 | 1250NH4G-S | - | |

* Contact Cooper Bussmann for availability

NH Fuses - Dimensions

Knife Fuses (NH)

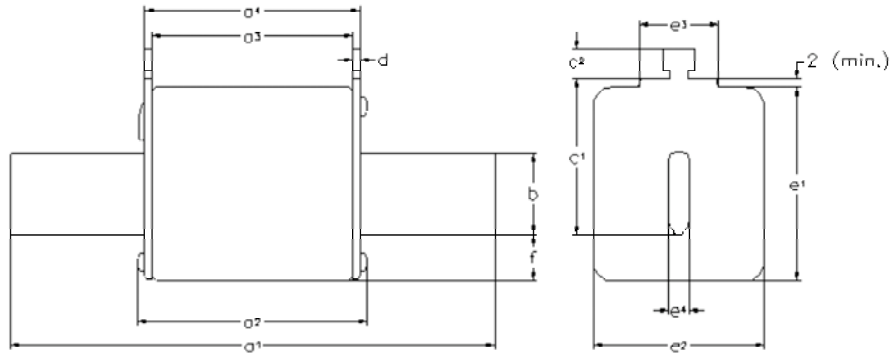

| Size a | a1 | a2 (max) | a3 | a4 | b (rated) | c1(±8) | c2 (rated) | D (rated) | e1 (max) | e2 (max) | e3 (max) | e4 (rated) | f (max) |
|-----------|----------|----------|------------------------|------------------------|-----------|--------|------------|-----------|----------|----------|----------|------------|---------|
| 000 | 78.5±1.5 | 54 | 45±1.5 | 49±1.5 | 15 | 35 | 10 | 2±0.5 | 48 | 30 | 25 | 6 | 15 |
| 00 | 78.5±1.5 | 54 | 45±1.5 | 49±1.5 | 15 | 35 | 11 | 2±0.5 | 48 | 30 | 25 | 6 | 15 |
| 0 | 125±2.5 | 68 | 62± ^{+3/-1.5} | 68± ^{+1.5/-3} | 15 | 35 | 11 | 2.5±0.5 | 48 | 30 | 25 | 6 | 15 |
| 01 | 135±2.5 | 75 | 62±2.5 | 68±2.5 | 15 | 40 | 11 | 2.5±0.5 | 48 | 30 | 25 | 6 | 15 |
| 1 | 135±2.5 | 75 | 62±2.5 | 68±2.5 | 20 | 40 | 11 | 2.5±0.5 | 53 | 52 | 25 | 6 | 15 |
| 02 | 150±2.5 | 75 | 62±2.5 | 68±2.5 | 20 | 48 | 11 | 2.5±0.5 | 53 | 52 | 25 | 6 | 15 |
| 2 | 150±2.5 | 75 | 62±2.5 | 68±2.5 | 25 | 48 | 11 | 2.5±0.5 | 61 | 60 | 25 | 6 | 15 |
| 03 | 150±2.5 | 75 | 62±2.5 | 68±2.5 | 25 | 60 | 11 | 2.5±0.5 | 61 | 60 | 25 | 6 | 15 |
| 3 | 150±2.5 | 75 | 62±2.5 | 68±2.5 | 32 | 60 | 11 | 3±0.5 | 76 | 60 | 25 | 6 | 18 |
| 4a | 200 | 84 | 80 | 90 | 50 | 85 | | 3 | 102 | 87 | | | 30 |
| 4a -1600A | 200 | 84 | 80 | 90 | 50 | 85 | | 3 | 102 | 87 | | | 30 |

NH Fuse Holders for Knife Fuses

SB-D, SB-S, SB-DMS
690V / 160 - 1600A

Sizes 00, 0, 1, 2, 3, 4



Specifications

Description: Knife fuses, NH, thermoplastic bodies for knife fuses. Securing to DIN rail and by screws (size 4 screw fixation only). Range of protection accessories for live parts in order to obtain IP20 protection standard. Available with micro-switch contact for use with fuses with striker (see page 30).

Ratings:

- Volts: - up to 690V ac
- Amps: - 2 - 1600A

Applications: Protection of industrial circuits and electrical apparatus

Standards and Approvals: IEC 60269, VDE 0636, DIN 43620

Dimensions

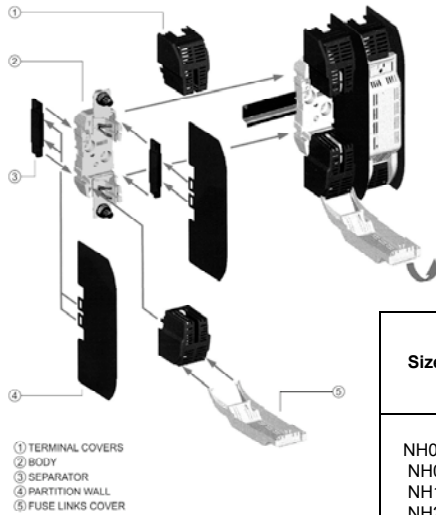

Catalogue Numbers

| Size | Poles | Current (A) | Part References | | With micro-switch contact | UP* |
|------|--------|-------------|------------------|---------------------------------|---------------------------|-------------|
| | | | Screw connection | DIN Rail connection | | |
| 00 | 1 3 | 160A | SB00-S TB00-S | SB00-D TB00-D TB00-D-IP20 | | 3 1 1 |
| 0 | 1 3 | 160A | SB0-S TB0-S | SB0-D TB0-D | SB0-DMS | 3 1 |
| 1 | 1 3 | 250A | SB1-S TB1-S | SB1-D TB1-D | SB1-DMS | 3 1 |
| 2 | 1 3 | 400A | SB2-S TB2-S | SB2-D TB2-D | SB2-DMS | 3 1 |
| 3 | 1 3 | 630A | SB3-S TB3-S | SB3-D TB3-D | SB3-DMS | 3 1 |
| 4 | 1 | 1600A | SB4-S | | SB4-DMS | 3 |

Neutral

| Size | Current (A) | Part Ref | Unit Packing |
|------|-------------|----------|--------------|
| NH00 | 160 | SL00 | 3 |
| NH0 | 160 | SL0 | |
| NH1 | 250 | SL1 | |
| NH2 | 400 | SL2 | |
| NH3 | 630 | SL3 | |
| NH4 | 1000 | SL4 | |

Fuse extraction handle

| Size | Part Ref | Unit Packing |
|-------|----------|--------------|
| C00-3 | FEH | 1 |

Protection accessories

| Size | Current (A) | Separation Partition ④ | | Fuse Cover ⑤ | | Terminal Cover ① | | Separator ③ | |
|------|-------------|------------------------|--------------|--------------|--------------|------------------|--------------|-------------|--------------|
| | | Part Ref | Unit Packing | Part Ref | Unit Packing | Part Ref | Unit Packing | Part Ref | Unit Packing |
| NH00 | 160A | SP00 | 2 | FC00 | 3 | CS00 | 6 | BC00 | 2 |
| NH0 | 160A | SP0 | 2 | FC0 | 3 | CS0 | 6 | BC0 | 2 |
| NH1 | 250A | SP1-2 | 2 | FC1 | 3 | CS1 | 6 | BC1-2 | 2 |
| NH2 | 400A | SP1-2 | 2 | FC2 | 3 | CS2 | 6 | BC1-2 | 2 |
| NH3 | 630A | SP3 | 2 | FC3 | 3 | CS3 | 6 | BC3 | 2 |
| NH4 | 1250A | SP4 | 2 | | | | | | |

IP Protection Kits

| | |
|-------------|---|
| TB00-D-IP20 | Complete triple pole fuse base IP20 rated |
| FPK0-3P | IP20 kit for TB0-D fuse base |
| FPK1-3P | IP20 kit for TB1-D fuse base |
| FPK2-3P | IP20 kit for TB2-D fuse base |
| FPK3-3P | IP20 kit for TB3-D fuse base |

Dimensions for Knife Fuse and Fuseholders (NH)

Knife Fuseholders (NH)

Bases for fuseholders size 00

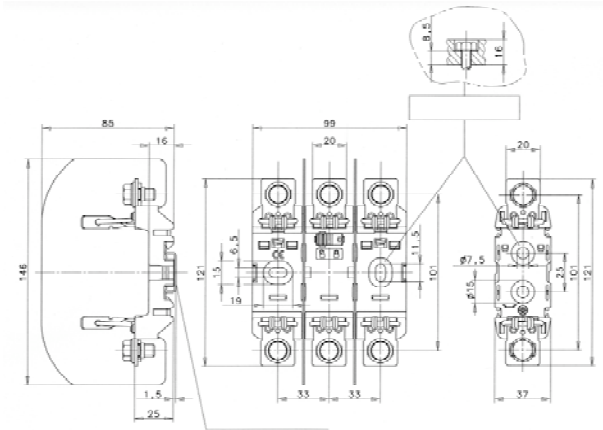

Bases for fuseholders size 0, 1, 2, 3, 4

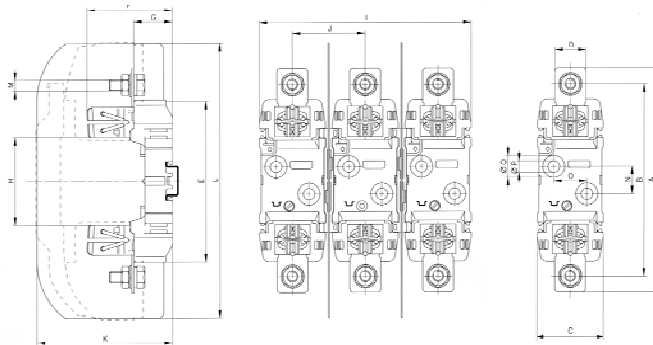

| Size | A | B | C | D | E | F | G | H | I | J | K | L | M | N | O | P | Q |
|------|-----|-----|----|----|-----|------|----|----|-----|------|------|-----|-----|----|----|------|------|
| NH0 | 170 | 150 | 47 | 24 | 122 | 63 | 63 | 29 | 74 | 48.5 | 91.5 | 185 | MB | 25 | - | 7.5 | 15 |
| NH1 | 200 | 175 | 60 | 28 | 148 | 77.5 | 35 | 80 | 192 | 66 | 123 | 250 | M10 | 25 | 30 | 10.5 | 20.5 |
| NH2 | 225 | 200 | 60 | 32 | 148 | 88 | 35 | 80 | 192 | 66 | 123 | 250 | M12 | 25 | 30 | 10.5 | 20.5 |
| NH3 | 240 | 210 | 60 | 38 | 148 | 97 | 35 | 80 | 224 | 82 | 143 | 270 | M12 | 25 | 30 | 10.5 | 20.5 |

Bases for fuse holders size 4

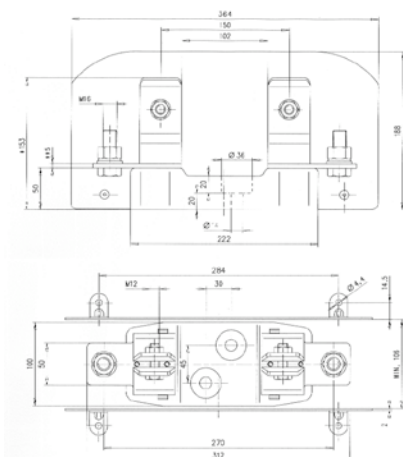

Dimensions for Knife Fuses and Fuseholders NH

Knife Fuseholders (NH)

Bases for fuseholders with micro circuit-breaker

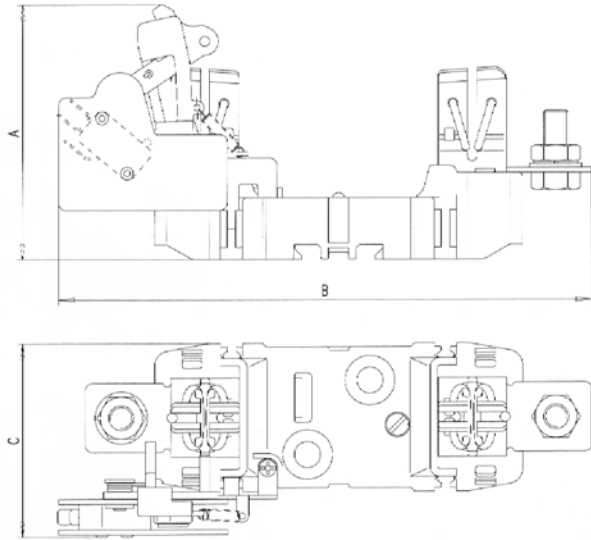

| Size | A | B | C |
|------|-----|-----|------|
| NH0 | 90 | 193 | 65.5 |
| NH1 | 98 | 215 | 76 |
| NH2 | 102 | 227 | 76 |
| NH3 | 102 | 235 | 76 |
| NH4 | 140 | 284 | 113 |

NH Fuse Rail

Vertical Style BFRD 690V / 250-630A

Sizes 1, 2, 3

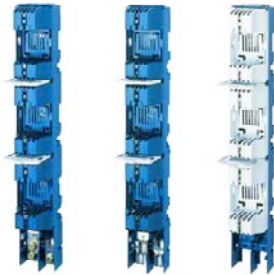

Specifications

Description: Vertical Fuse Rails are designed to be used with NH Fuses. Fully protected against accidental contacts.

Main features are:

- Contact covers
- Inter polar barriers
- Label for protected circuit identification
- Busbar mounting with screws

Ratings:

Volts: - 690V ac
Amps: - 250 - 630A

Applications: Disconnecting cabinets and low voltage distribution switchboards with busbar spacing of 185mm

Standards and Approvals: CE, IEC EN 60269-1, IEC EN 60269-3-1

Dimensions:

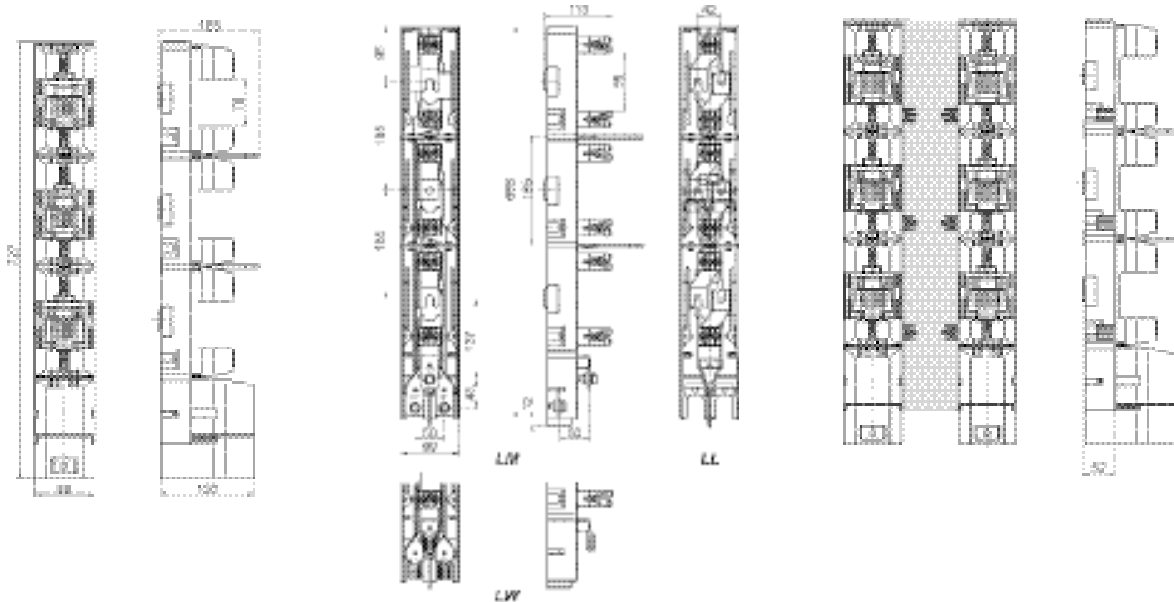

Catalogue Numbers

| Size | Rating (A) | Part Reference | Leading out Terminals |
|------|------------|------------------|---|
| 1 | 250 | BFR1-3K/LM/C (*) | Pressed-in Nuts with M10 Screw |
| | | BFR1-3K/LW | V-Shaped Clamps |
| | | BFR1-3K/LL | Busbar Systems 185mm Busbar Spacing Connects to Busbar with M12 bolts |
| 2 | 400 | BFR2-3K/LM/C (*) | Pressed-in Nuts with M10 Screw |
| | | BFR2-3K/LW | V-Shaped Clamps |
| | | BFR2-3K/LL | Busbar Systems 185mm Busbar Spacing Connects to Busbar with M12 bolts |
| 3 | 630 | BFR3-3K/LM/C (*) | Pressed-in Nuts with M10 Screw |
| | | BFR3-3K/LW | V-Shaped Clamps |
| | | BFR3-3K/LL | Busbar Systems 185mm Busbar Spacing Connects to Busbar with M12 bolts |

(*) with Leading-out Terminal cover

NH Fuse Switch Disconnectors

Horizontal Style BFH 690V / 160 - 1600A

Sizes 000, 00, 1, 2, 3, 4A

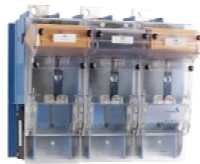

Specifications

Description: Horizontal Switch disconnectors are designed to be used with NH Fuses. Enabling safe connection and disconnection operations. Main features are:

- Measuring holes in the fuse cover
- Possibility to lock the fuse cover
- Label for protected circuit identification
- Panel mounting with screws. On 35mm DIN Rail (only size 000)

Ratings:

- Volts: - 690V ac / 250V dc (sizes 1,2,3) / 400V dc (size 000)
- Amps: - 160 - 1600A
- Utilization category: - 400V ac - AC23B
- 500V ac - AC22B
- 690V ac - AC21B
- 250V dc - DC21B (sizes 1,2,3)
- 250V dc - DC22B (sizes 000, 00)
- 440V dc - DC20B

Applications: Industrial control panels, motor control panels

Approvals: CE, IEC EN 60947-1, IEC EN 60947-3

Dimensions:

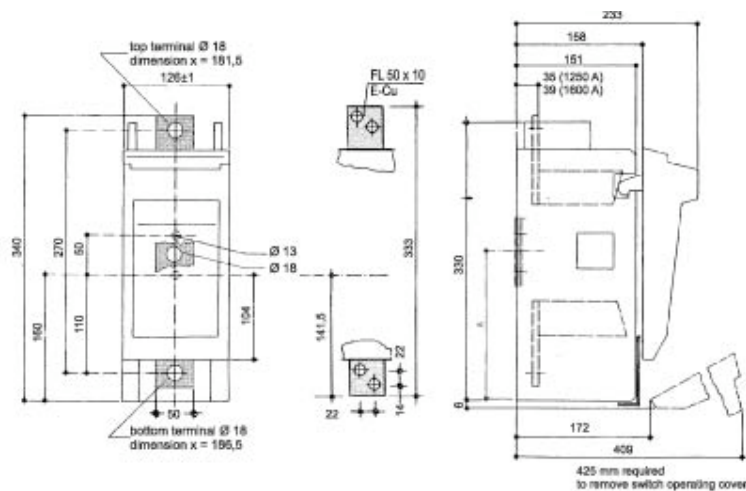

Catalogue Numbers

| Size | Rating (A) | Catalogue Number | | Terminals | UP* |
|------|------------|------------------|-------------|--|-----|
| | | 1 Pole | 3 Poles | | |
| 000 | 160 | BFH000-1A/T | BFH000-3A/T | Terminal Clips for 1.5- to 50mm ² cable | 1 |
| 00 | 160 | BFH00-1A/F | BFH00-3A/F | Terminal Screw M8 | 1 |
| 1 | 250 | BFH1-1A/F | BFH1-3A/F | Terminal Screws M10 | 1 |
| 2 | 400 | BFH2-1A/F | BFH2-3A/F | Terminal Screws M10 | 1 |
| 3 | 630 | BFH3-1A/F | BFH3-3A/F | Terminal Screws M12 | 1 |
| 4A | 1600 | LBS4/1 | LBS4/3 | Terminal Screws 2xM12 | 1 |

* UP = Unit Packing

DO Fuses

Class gG
400V / 2 - 100A

Sizes D01, D02, D03



Specifications

Description: DO fuses, gG range, for industrial and domestic protection. All the fuses incorporate a visual display of fuse actuation. Additional range of fuse holders and accessories.

Ratings:

- Volts: - 690V ac
- Amps: - 160 - 1600A
- IR - 50kA - 400V ac

Applications: Protection of electrical distribution circuits, cables and electrical apparatus (with the exception of motors).

Standards and Approvals: IEC 60269, VDE 0636,

Catalogue Numbers

| Size | Current (A) | Colour Code | Part Ref | Voltage (V) | Disconnection Power (kA) | Unit Packing |
|------|-------------|-------------|----------|-------------|--------------------------|--------------|
| D01 | 2 | Pink | 2NZ01 | 400V | 100kA | 10 |
| | 4 | Brown | 4NZ01 | | | |
| | 6 | Green | 6NZ01 | | | |
| | 10 | Red | 10NZ01 | | | |
| | 16 | Grey | 16NZ01 | | | |
| D02 | 20 | Blue | 20NZ02 | 400V | 100kA | 10 |
| | 25 | Yellow | 25NZ02 | | | |
| | 35 | White | 35NZ02 | | | |
| | 50 | Black | 50NZ02 | | | |
| | 63 | Copper | 63NZ02 | | | |
| D03 | 80 | Silver | 80NZ03 | 400V | 100kA | 10 |
| | 100 | Red | 100NZ03 | | | |

Dimensions

D01

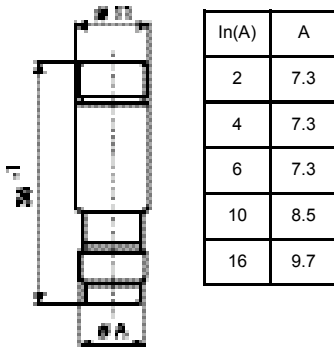

D02

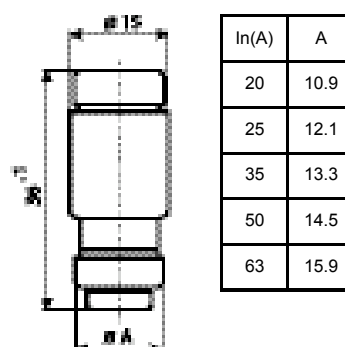

D03

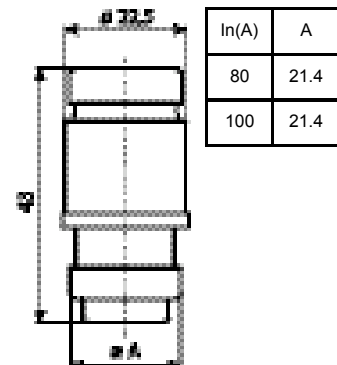

DO Fuseholders

FN C , TFN C, FRN C, TFRN C
400V / 16 - 100A

Sizes D01, D02, D03

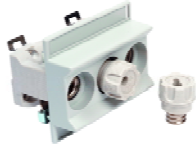

Specifications

Description: DO fuse carriers in ceramic bodies with versions for securing to DIN rail or screw connection. Complete range of accessories.

Ratings:

Volts: - 400V ac
Amps: - 16 - 100A

Applications: Protection of industrial circuits and electrical apparatus.

Standards and Approvals: IEC 60269, VDE 0636,

Dimensions

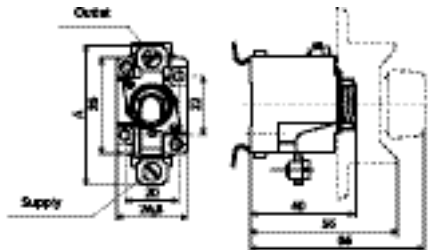

| Size | A |
|------|----|
| DO1 | 53 |
| DO2 | 57 |

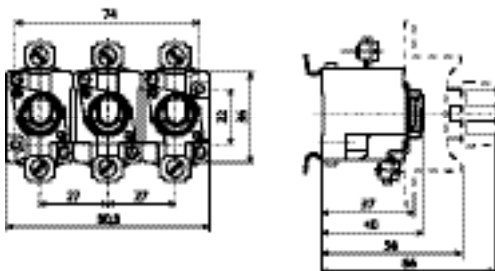

Catalogue Numbers

| Size | Current (A) | Part Ref Screw Connection | | Part Ref DIN Rail Connection | | Unit Packing |
|------|-------------|---------------------------|------------|------------------------------|------------|-------------------|
| | | Single Pole | Three Pole | Single Pole | Three Pole | |
| DO1 | 16A | FN01C | TFN01C | FRN01C | TFRN1C | 15/5 (Three Pole) |
| DO2 | 63A | FN02C | TFN02C | FRN02C | TFRN2C | 15/5 (Three Pole) |

Accessories

| Accessories | Size | Current (A) | Fuse Base Type | References | Unit Packing |
|------------------------|------------|----------------------------|----------------|--|--------------|
| Fuse Carrier | DO1 DO2 | 16 63 | E14 E18 | CN01 CN02 | 20 |
| Gauge/Calibration ring | DO1 | 2 4 6 10 | E14 | 2GN01 4GN01 6GN01 10GN01 | 50 |
| | DO2 | 16 20 25 35 50 | E18 | 16GN02 20GN02 25GN02 35GN02 50GN02 | |
| Covers | DO1 1 pole | 16 | E14 | SFPCDO1 | 50 |
| | DO2 1 pole | 63 | E18 | SFPCDO2 | |
| | DO1 3 pole | 16 | E14 | TFPCDO1 | 30 |
| | DO2 3 pole | 63 | E18 | TFPCDO2 | |

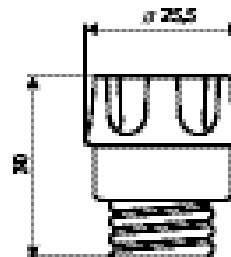
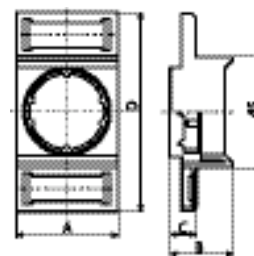

D Fuses

**Class gG
500V / 2 - 200A**

Sizes: DI, DII, DIII, DIV, DV



Specifications

Description: D fuses, gG range, for industrial and domestic protection. All the fuses incorporate a visual display of fuse actuation. Additional range of fuse holders and accessories.

Ratings:

- Volts: - 690V ac
- Amps: - 2 - 200A
- IR - 50kA - 500V ac

Applications: Protection of electrical distribution circuits, cables and electrical apparatus (with the exception of motors).

Standards and Approvals: IEC 60269, VDE 0636,

Dimensions

Catalogue Numbers

| Size | Current (A) | Colour Code | References | Voltage (V) | Disconnection Power (kA) | Unit Packing |
|------|-------------|-------------|------------|-------------|--------------------------|--------------|
| DI | 2 | Pink | 2D16 | 500V | 100kA | 10 |
| | 4 | Brown | 4D16 | | | |
| | 6 | Green | 6D16 | | | |
| | 10 | Red | 10D16 | | | |
| | 16 | Grey | 16D16 | | | |
| | 20 | Blue | 20D16 | | | |
| | 25 | Yellow | 25D16 | | | |
| DII | 2 | Pink | 2D27 | 500V | 100kA | 10 |
| | 4 | Brown | 4D27 | | | |
| | 6 | Green | 6D27 | | | |
| | 10 | Red | 10D27 | | | |
| | 16 | Grey | 16D27 | | | |
| | 20 | Blue | 20D27 | | | |
| | 25 | Yellow | 25D27 | | | |
| DIII | 35 | Black | 35D33 | 500V | 100kA | 10 |
| | 50 | White | 50D33 | | | |
| | 63 | Copper | 63D33 | | | |
| DIV | 80 | Silver | 80D125 | 500V | 100kA | 10 |
| | 100 | Red | 100D125 | | | |

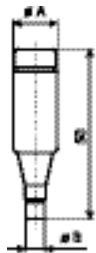

| Int (A) | A | B |
|---------|------|----|
| 2 | 13.2 | 6 |
| 4 | | 6 |
| 6 | | 6 |
| 10 | | 8 |
| 16 | | 10 |
| 20 | | 12 |
| 25 | | 14 |

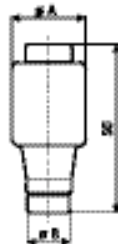

| Int (A) | A | B |
|---------|------|----|
| 2 | 21.5 | 6 |
| 4 | | 6 |
| 6 | | 6 |
| 10 | | 8 |
| 16 | | 10 |
| 20 | | 12 |
| 25 | | 14 |

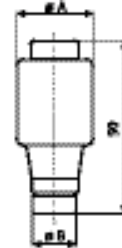

| Int (A) | A | B |
|---------|----|----|
| 35 | 27 | 16 |
| 50 | 27 | 16 |
| 63 | 27 | 18 |

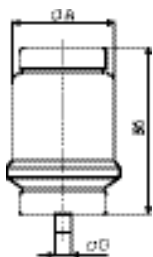

| Int (A) | A | B |
|---------|----|----|
| 35 | 27 | 16 |
| 50 | 27 | 16 |

D Fuseholders

SFD, TFD, SFRD C , TFR
500V / 25 - 63A

Sizes: DII, DIII



Specifications

Description: D fuse carriers in ceramic bodies with versions for securing to DIN rail or screw connection. Complete range of accessories.

Ratings:

Volts: - 500V ac
Amps: - 25 - 63A

Applications: Protection of industrial circuits and electrical apparatus.

Standards and Approvals: IEC 60269, VDE 0636,

Dimensions

Catalogue Numbers

| Size | Current (A) | Part Ref Screw Connection | | Part Ref DIN Rail Connection | | Unit Packing |
|------|-------------|---------------------------|------------|------------------------------|------------|-----------------------|
| | | Single Pole | Three Pole | Single Pole | Three Pole | |
| DI | 25A | SFD27 | TFD27 | SFRD27 | TFRD27 | 15/4 (Three Terminal) |
| DIII | 63A | SFD33 | TFD33 | SFRD33 | TFRD33 | 15/6 (Three Terminal) |

Accessories

| Accessories | Size | Current (A) | Fuse Base Type | References | Unit Packing |
|-------------------------|-------------|-------------|----------------|------------|--------------|
| Fuse Carrier | DII | 25A | E27 | CD27 | 50 |
| | DIII | 63A | E33 | CD33 | 30 |
| Gauge/ Calibration Ring | DII | 2 | E27 | 2GD27 | 50 |
| | | 4 | | 4GD27 | |
| 6 | | 6GD27 | | | |
| 10 | | 10GD27 | | | |
| 16 | | 16GD27 | | | |
| 20 | 20GD27 | | | | |
| 25 | 25GD27 | | | | |
| DIII | 35 | E33 | 35GD33 | | |
| | 50 | | 50GD33 | | |
| | 63 | | 63GD33 | | |
| Covers | DII 1 pole | 25 | E27 | SFPRD27 | 50 |
| | DIII 1 pole | 63 | E33 | SFPRD27 | |
| | DII 3 pole | 25 | E27 | TFPCD27 | |
| | DIII 3 pole | 63 | E33 | TFPCD33 | |

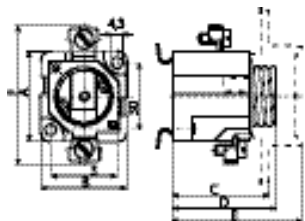

| Size | A | B | C | D | E | F |
|------|----|----|----|----|----|----|
| DII | 41 | 39 | 44 | 47 | 60 | 62 |
| DIII | 43 | 47 | 44 | 47 | 56 | 79 |

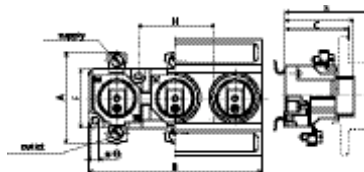

| Size | A | B | C | D | E | F | G | H |
|------|----|-----|----|----|----|----|-----|----|
| DII | 41 | 121 | 44 | 47 | 60 | 30 | 4.3 | 50 |
| DIII | 43 | 148 | 44 | 47 | 56 | 32 | 4.3 | 62 |

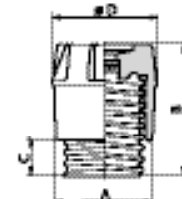

| Size | A | B | C | D |
|------|---|----|----|----|
| DII | E | 44 | 12 | 34 |
| DIII | E | 44 | 12 | 43 |

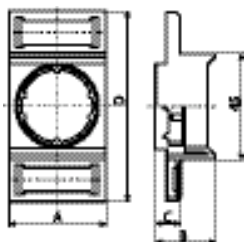

| 1 Pole | A | B | C | D |
|--------|----|----|------|----|
| DII | 40 | 24 | 10.8 | 80 |
| DIII | 49 | 21 | 9 | 80 |

| 3 Pole | A | B | C | D |
|--------|-----|----|------|----|
| DII | 121 | 24 | 10.8 | 80 |
| DIII | 148 | 21 | 9 | 80 |

Other Low Voltage Fuse Ranges

North American Standard Fuses and Holders



Specifications

Description: Round fuses and holders in accordance with North American standards. Some ranges available with fuse actuation display.

Makes: CUBEFuse TM low-peak, Fusetron, Limitron, CC-Tron, Dura-LagTM, T-Tron, Optima.

Modular fuse holders (class CC, Midget and class J), fuse holders and isolator circuit-breakers.

Ratings:

Volts: - 125 to 600V ac
Amps: - 100mA to 6000A
IR - 300kA

Applications: General use for all types of protection and also motor protection.

Standards and Approvals: Classes UL and CSA certified (consult us for types)

Dimensions: Miniature, class CC, class RK5, class RK1, class J, class G, Midget, class L.

Medium Voltage Fuses and Isolators

Fuses for Voltage and Transformer Auxiliary Fuses



Specifications

Description: Medium Voltage fuses with low current values, which allow for the associated system to be isolated in the event of a fault in the transformer circuit.

Ratings:

- Volts: - 1 to 36kV ac
- Amps: - 2 - 10A
- IR - 25 - 50kA

Applications: For use in the voltage transformer primary circuit and in transformer auxiliary elements, etc.

Standards and Approvals: BS2692-1, IEC 60282-1

Dimensions: Cylindrical body fuses with various length and diameter dimensions

Other MV Fuses

DIN Fuses



Specifications

Description: Complete range of fuses (back-up, full range), and also motor protection.

Ratings:

- Volts: - 12 to 36kV ac
- Amps: - 6.3 to 160A

Dimensions: DIN 43625, EN IEC 60782-1, VDE 0670-4

Oil Fuses



Specifications

Description: Fuses for use in oil-insulated isolators and circuit breakers. Fuses fitted with a pyrotechnic plunger.

Ratings:

- Volts: - 3.6 to 24kV ac
- Amps: - 6.3 to 250A

Dimensions: BS 2692-1, ESI 12-8, EN IEC 60292-1

Starter Motor Fuses



Specifications

Description: Fuses to provide protection against short-circuit in motor and engine circuits.

Ratings:

- Volts: - 3.6 to 7.2kV ac
- Amps: - 5 to 400A

Dimensions: Conform to British Standards, Standards UL and IEC DIN 43625

Ultra Fast Fuses and Holders

British Standard Fuses and Holders



Specifications

Description: Standard British ultra-fast fuses. Possibility of adapting side indicators and auxiliary micro-switch as accessories.

Ratings:

- Volts: - 240 - 690V ac / 150 to 500V dc
- Amps: - 6 - 900A
- IR - 200ka RMS Sym

Applications: Protection of semiconductors, UPS (ASI), rectifiers, static relays, converters etc

Standards and Approvals: Conform to standards BS88-4, EN IEC 60269-5, UL recognized

Dimensions: Various fuses sizes in single or double cylindrical body

North American Standard Fuses and Holders



Specifications

Description: Standard North American ultra-fast fuses. Fuse actuation display available on external and internal versions. Limited range of fuse bases

Ratings:

- Volts: - 130 to 1000V ac / 130 to 800V dc
- Amps: - 1 to 4000A
- IR - 200kA RMS Sym

Applications: Protection of semiconductors, UPS (ASI), rectifiers, static relays, converters, etc.

Standards and Approvals: UL Recognised, CSA, Component Acceptance

Dimensions: There are no standard dimensions with these types of fuses.

Ultra Fast Fuses and Holders

Cylindrical Fuses and Holders



Specifications

Description: Ultra Fast cylindrical fuses. Standard ranges without fuses actuation indicator and ranges with fuse blown indicator. Modular fuse holders (type CH) for sizes 10x38, 14x51 and 22x58, with light display and ancillary elements. Fuse holders for size 22x58.

Ratings:

Volts: - 150 - 2000V ac / 150 to 1000V dc
 Amps: - 1 - 100A
 IR - 25 to 200kA RMS Sym

Applications: Protection of semi-conductors, UPS (ASI), rectifiers, static relays, converters.

Standards and Approvals: Conform to standards IEC 60269, UL Recognition, CSA Component Acceptance (consult us).

Dimensions: Variety of fuse sizes: from 6x32, 25x146

Square Body Fuses and Holders



Specifications

Description: Ultra Fast square-body fuses, in versions with visual indicator and striker for use with auxiliary micro-switch. Fuses in formats DIN 43620, DIN 43653 (DIN 110 and DIN 80), French standard, North American standard.

Fuse bases to DIN 43620 and 43653.

Ratings:

Volts: - 690 to 3000V ac
 Amps: - 10 to 700A
 IR - 300kA RMS Sym

Applications: Protection of semiconductors, UPS (ASI), rectifiers, static relays, converters.

Standards and Approvals: Conform to standards IEC 60269-4, UL Recognition, CSA Component Acceptance (consult us).

Dimensions: Sizes 000, 00, 0, 1*, 1, 2, 3, 4, 5

Index

| Catalogue Number | Page | Catalogue Number | Page | Catalogue Number | Page | Catalogue Number | Page |
|------------------|------|------------------|------|------------------|------|------------------|------|
| 011-9127 | 18 | 100NHG01B-400 | 25 | 125NHG02BI | 26 | 16NHG000B-690 | 27 |
| 011-9128 | 18 | 100NHG01BI | 26 | 125NHG02BI-400 | 25 | 16NHG000BI | 26 |
| 011-9129 | 18 | 100NHG01BI-400 | 25 | 125NHG0B | 26 | 16NHG000BI-400 | 25 |
| 011-9483 | 18 | 100NHG02B | 26 | 125NHG1B-690 | 27 | 16NHG000BI-690 | 27 |
| 011-9679 | 18 | 100NHG02B-400 | 25 | 125NHG1BI-690 | 27 | 16NHG01B | 26 |
| 012-0140 | 18 | 100NHG02BI | 26 | 125NHG1BS-690 | 30 | 16NHG01BI | 26 |
| 012-0141 | 18 | 100NHG02BI-400 | 25 | 125NHG2B-690 | 27 | 16NHG0B | 26 |
| 059-0067 | 18 | 100NHG0B | 26 | 125NHG2BI-690 | 27 | 16NHG0B-690 | 27 |
| 059-0107 | 18 | 100NHG0B-690 | 27 | 125NHG2BS-690 | 30 | 16NHM000B-690 | 28 |
| 059-0108 | 18 | 100NHG1B-690 | 27 | 125NHM00B | 28 | 16NHM000BI-690 | 28 |
| 059-0109 | 18 | 100NHG1BI-690 | 27 | 125NHM00BI | 28 | 16NHM0B | 28 |
| 059-0110 | 18 | 100NHG1BS-690 | 30 | 125NHM1B | 28 | 16NZ01 | 35 |
| 059-0111 | 18 | 100NHG2B-690 | 27 | 125NHM1BI | 28 | 200DF | 19 |
| 059-0112 | 18 | 100NHG2BI-690 | 27 | 125NHM1BS-690 | 30 | 200M09-660 | 13 |
| 059-0113 | 18 | 100NHM00B | 28 | 125NHM2B-690 | 28 | 200M13 | 14 |
| 059-0114 | 18 | 100NHM00BI | 28 | 125NHM2BI-690 | 28 | 200M14-660 | 12 |
| 059-0115 | 18 | 100NHM0B | 28 | 125NHM2BS-690 | 30 | 200M23 | 14 |
| 059-0116 | 18 | 100NHM1B | 28 | 15KR85 | 16 | 200MJ25-6 | 16 |
| 059-0117 | 18 | 100NHM1BI | 28 | 1600NH4AG | 26 | 200MJ29-6 | 17 |
| 059-0118 | 18 | 100NHM1BS-690 | 30 | 160M09-660 | 13 | 200MJ30-7 | 17 |
| 059-0119 | 18 | 100NZ03 | 35 | 160M13 | 14 | 200MJ31-7 | 17 |
| 059-0120 | 18 | 10D16 | 37 | 160M14-660 | 12 | 200N11-660 | 13 |
| 059-0121 | 18 | 10D27 | 37 | 160M23 | 14 | 200N20 | 14 |
| 059-0122 | 18 | 10GD27 | 38 | 160MJ25-6 | 16 | 200NH1M | 29 |
| 059-0123 | 18 | 10GN01 | 36 | 160MJ29-6 | 17 | 200NH2M | 29 |
| 059-0124 | 18 | 10H07-660 | 12 | 160MJ30-7 | 17 | 200NHG02B | 26 |
| 059-0125 | 18 | 10HS07 | 11 | 160MJ31-7 | 17 | 200NHG02B-400 | 25 |
| 059-0126 | 18 | 10K08-660 | 13 | 160N11-660 | 13 | 200NHG02BI | 26 |
| 059-0127 | 18 | 10K09-660 | 13 | 160N20 | 14 | 200NHG02BI-400 | 25 |
| 059-0128 | 18 | 10KR85 | 16 | 160NH00M | 29 | 200NHG1B | 26 |
| 059-0129 | 18 | 10KS09 | 11 | 160NH0M | 29 | 200NHG1B-400 | 25 |
| 059-0140 | 18 | 10NHC00M | 29 | 160NH1M | 29 | 200NHG1B-690 | 27 |
| 059-0141 | 18 | 10NHG000B | 26 | 160NH2M | 29 | 200NHG1BI | 26 |
| 059-0142 | 18 | 10NHG000B-400 | 25 | 160NHG00B | 26 | 200NHG1BI-400 | 25 |
| 059-0143 | 18 | 10NHG000B-690 | 27 | 160NHG00B-400 | 25 | 200NHG1BI-690 | 27 |
| 059-0144 | 18 | 10NHG000BI | 26 | 160NHG00BI | 26 | 200NHG1BS-690 | 30 |
| 059-0145 | 18 | 10NHG000BI-400 | 25 | 160NHG00BI-400 | 25 | 200NHG2B-690 | 27 |
| 059-0146 | 18 | 10NHG000BI-690 | 27 | 160NHG01B | 26 | 200NHG2BI-690 | 27 |
| 059-0147 | 18 | 10NHG01B | 26 | 160NHG01B-400 | 25 | 200NHG2BS-690 | 30 |
| 059-0148 | 18 | 10NHG01BI | 26 | 160NHG01BI | 26 | 200NHM1B | 28 |
| 059-0149 | 18 | 10NHG0B | 26 | 160NHG01BI-400 | 25 | 200NHM1BI | 28 |
| 059-0150 | 18 | 10NHG0B-690 | 27 | 160NHG02B | 26 | 200NHM1BS-690 | 30 |
| 059-0151 | 18 | 10NHM000B-690 | 28 | 160NHG02B-400 | 25 | 200NHM2B-690 | 28 |
| 059-0152 | 18 | 10NHM000BI-690 | 28 | 160NHG02BI | 26 | 200NHM2BI-690 | 28 |
| 059-0153 | 18 | 10NHM0B | 28 | 160NHG02BI-400 | 25 | 200NHM2BS-690 | 30 |
| 059-0154 | 18 | 10NZ01 | 35 | 160NHG0B | 26 | 20D16 | 37 |
| 059-0155 | 18 | 1250NH4AG | 26 | 160NHG1B-690 | 27 | 20D27 | 37 |
| 059-9925 | 18 | 1250NH4G-S | 30 | 160NHG1BI-690 | 27 | 20GD27 | 38 |
| 059-9926 | 18 | 1250NHG4G | 26 | 160NHG1BS-690 | 30 | 20GN02 | 36 |
| 1000NH4AG | 26 | 125M09-660 | 13 | 160NHG2B-690 | 27 | 20H07-660 | 12 |
| 1000NH4G-S | 30 | 125M13 | 14 | 160NHG2BI-690 | 27 | 20HS07 | 11 |
| 1000NHG4G | 26 | 125M14-660 | 12 | 160NHG2BS-690 | 30 | 20K08-660 | 13 |
| 100D125 | 37 | 125M23 | 14 | 160NHM00B | 28 | 20K09-660 | 13 |
| 100KR85 | 16 | 125MJ25-6 | 16 | 160NHM00BI | 28 | 20KR85 | 16 |
| 100L09-660 | 13 | 125MJ30-7 | 17 | 160NHM1B | 28 | 20KS09 | 11 |
| 100L14-660 | 12 | 125MJ31-7 | 17 | 160NHM1BI | 28 | 20MJ25-6 | 16 |
| 100LR85 | 16 | 125N11-660 | 13 | 160NHM1BS-690 | 30 | 20MJ31-8 | 17 |
| 100MJ25-6 | 16 | 125N20 | 14 | 160NHM2B-690 | 28 | 20NHCO0M | 29 |
| 100MJ29-6 | 17 | 125NH00M | 29 | 160NHM2BI-690 | 28 | 20NHG000B | 26 |
| 100MJ30-7 | 17 | 125NH0M | 29 | 160NHM2BS-690 | 30 | 20NHG000B-400 | 25 |
| 100MJ31-7 | 17 | 125NH1M | 29 | 16D16 | 37 | 20NHG000B-690 | 27 |
| 100NH00M | 29 | 125NH2M | 29 | 16D27 | 37 | 20NHG000BI | 26 |
| 100NH0M | 29 | 125NHG00B | 26 | 16GD27 | 38 | 20NHG000BI-400 | 25 |
| 100NH1M | 29 | 125NHG00B-400 | 25 | 16GN02 | 36 | 20NHG000BI-690 | 27 |
| 100NH2M | 29 | 125NHG00BI | 26 | 16H07-660 | 12 | 20NHG01B | 26 |
| 100NHG000B | 26 | 125NHG00BI-400 | 25 | 16HS07 | 11 | 20NHG01BI | 26 |
| 100NHG000B-400 | 25 | 125NHG01B | 26 | 16K08-660 | 13 | 20NHG0B | 26 |
| 100NHG000BI | 26 | 125NHG01BI-400 | 25 | 16K09-660 | 13 | 20NHG0B-690 | 27 |
| 100NHG000BI-400 | 25 | 125NHG01BI | 26 | 16KS09 | 11 | 20NHM000B-690 | 28 |
| 100NHG00B-690 | 27 | 125NHG01BI-400 | 25 | 16NHC00M | 29 | 20NHM000BI-690 | 28 |
| 100NHG00BI-690 | 27 | 125NHG02B | 26 | 16NHG000B | 26 | 20NHM0B | 28 |
| 100NHG01B | 26 | 125NHG02B-400 | 25 | 16NHG000B-400 | 25 | 20NZ02 | 35 |

Index

| Catalogue Number | Page | Catalogue Number | Page | Catalogue Number | Page | Catalogue Number | Page |
|------------------|------|------------------|------|------------------|------|------------------|------|
| 224NHG02B | 26 | 25NHG01B | 26 | 32NHG000B-400 | 25 | 400NHG2BI | 26 |
| 224NHG02B-400 | 25 | 25NHG01BI | 26 | 32NHG000B-690 | 27 | 400NHG2BI-400 | 25 |
| 224NHG02BI | 26 | 25NHG0B | 26 | 32NHG000BI | 26 | 400NHG3B-690 | 27 |
| 224NHG02BI-400 | 25 | 25NHG0B-690 | 27 | 32NHG000BI-400 | 25 | 400NHG3BI-690 | 27 |
| 224NHG1B | 26 | 25NHM000B-690 | 28 | 32NHG000BI-690 | 27 | 400NHG3BS-690 | 30 |
| 224NHG1B-400 | 25 | 25NHM000BI-690 | 28 | 32NHG01B | 26 | 400NHM2B | 28 |
| 224NHG1B-690 | 27 | 25NHM0B | 28 | 32NHG01BI | 26 | 400NHM2BI | 28 |
| 224NHG1BI | 26 | 25NZ02 | 35 | 32NHG0B | 26 | 400NHM2BS-690 | 30 |
| 224NHG1BI-400 | 25 | 2D16 | 37 | 32NHG0B-690 | 27 | 400NHM3B-690 | 28 |
| 224NHG1BI-690 | 27 | 2D27 | 37 | 32NHM000B-690 | 28 | 400NHM3BI-690 | 28 |
| 224NHG2B-690 | 27 | 2GD27 | 38 | 32NHM000BI-690 | 28 | 400NHM3BS-690 | 30 |
| 224NHG2BI-690 | 27 | 2GN01 | 36 | 32NHM0B | 28 | 400P09-660 | 13 |
| 224NHG2BS-690 | 30 | 2H07-660 | 12 | 32NNL | 20 | 400P11-660 | 13 |
| 224NHM1B | 28 | 2K08-660 | 13 | 32NNSBS | 20 | 400P12-660 | 13 |
| 224NHM1BI | 28 | 2K09-660 | 13 | 32NNSF | 20 | 400P20 | 14 |
| 224NHM1BS-690 | 30 | 2NHC00M | 29 | 32NNSFBS | 20 | 400P35 | 14 |
| 224NHM2B-690 | 28 | 2NHG000B | 26 | 355NH2M | 29 | 400PJ30-7 | 17 |
| 224NHM2BI-690 | 28 | 2NHG000B-400 | 25 | 355NHG03B | 26 | 400PJ31-7 | 17 |
| 224NHM2BS-690 | 30 | 2NHG000B-690 | 27 | 355NHG03B-400 | 25 | 40K07-660 | 12 |
| 250M13 | 14 | 2NHG000BI | 26 | 355NHG03BI | 26 | 40K08-660 | 13 |
| 250MJ25-6 | 16 | 2NHG000BI-400 | 25 | 355NHG03BI-400 | 25 | 40K09-660 | 13 |
| 250MJ29-6 | 17 | 2NHG000BI-690 | 27 | 355NHG2B | 26 | 40KR85 | 16 |
| 250MJ30-7 | 17 | 2NZ01 | 35 | 355NHG2B-400 | 25 | 40KS07 | 11 |
| 250MJ31-7 | 17 | 30KR85 | 16 | 355NHG2BI | 26 | 40KS08 | 11 |
| 250N09-600 | 13 | 30LR85 | 16 | 355NHG2BI-400 | 25 | 40KS09 | 11 |
| 250N11-660 | 13 | 30NH00AD | 23 | 355NHG3B-690 | 27 | 40LR85 | 16 |
| 250N15 | 14 | 315M13 | 14 | 355NHG3BI-690 | 27 | 40MJ25-6 | 16 |
| 250N20 | 14 | 315MJ30-7 | 17 | 355NHG3BS-690 | 30 | 40MJ30-8 | 17 |
| 250N34 | 14 | 315MJ31-7 | 17 | 355NHM2B-690 | 28 | 40MJ31-8 | 17 |
| 250NH1M | 29 | 315N09-660 | 13 | 355NHM2BI-690 | 28 | 40NH1M | 29 |
| 250NH2M | 29 | 315N11-660 | 13 | 355NHM2BS-690 | 30 | 40NHC00M | 29 |
| 250NHG02B | 26 | 315N15 | 14 | 355NHM3B-690 | 28 | 40NHG000B | 26 |
| 250NHG02B-400 | 25 | 315N20 | 14 | 355NHM3BI-690 | 28 | 40NHG000B-400 | 25 |
| 250NHG02BI | 26 | 315N34 | 14 | 355P09-660 | 13 | 40NHG000B-690 | 27 |
| 250NHG02BI-400 | 25 | 315NH2M | 29 | 355P11-660 | 13 | 40NHG000BI | 26 |
| 250NHG03B | 26 | 315NH3M | 29 | 355P12-660 | 13 | 40NHG000BI-400 | 25 |
| 250NHG03B-400 | 25 | 315NHG03B | 26 | 355P20 | 14 | 40NHG000BI-690 | 27 |
| 250NHG03BI | 26 | 315NHG03B-400 | 25 | 355P35 | 14 | 40NHG01B | 26 |
| 250NHG03BI-400 | 25 | 315NHG03BI | 26 | 355PJ30-7 | 17 | 40NHG01B-400 | 25 |
| 250NHG1B | 26 | 315NHG03BI-400 | 25 | 355PJ31-7 | 17 | 40NHG01BI | 26 |
| 250NHG1B-400 | 25 | 315NHG2B | 26 | 35D33 | 37 | 40NHG01BI-400 | 25 |
| 250NHG1B-690 | 27 | 315NHG2B-400 | 25 | 35GD33 | 38 | 40NHG02B | 26 |
| 250NHG1BI | 26 | 315NHG2B-690 | 27 | 35GN02 | 36 | 40NHG02B-400 | 25 |
| 250NHG1BI-400 | 25 | 315NHG2BI | 26 | 35NHG000B | 26 | 40NHG02BI | 26 |
| 250NHG1BI-690 | 27 | 315NHG2BI-400 | 25 | 35NHG000B-400 | 25 | 40NHG02BI-400 | 25 |
| 250NHG2B-690 | 27 | 315NHG2BI-690 | 27 | 35NHG000B-690 | 27 | 40NHG0B | 26 |
| 250NHG2BI-690 | 27 | 315NHG2BS-690 | 30 | 35NHG000BI | 26 | 40NHG0B-690 | 27 |
| 250NHG2BS-690 | 30 | 315NHG3B-690 | 27 | 35NHG000BI-400 | 25 | 40NHM000B-690 | 28 |
| 250NHG3B-690 | 27 | 315NHG3BI-690 | 27 | 35NHG000BI-690 | 27 | 40NHM000BI-690 | 28 |
| 250NHG3BI-690 | 27 | 315NHG3BS-690 | 30 | 35NHG01B | 26 | 40NHM0B | 28 |
| 250NHM1B | 28 | 315NHM2B-690 | 28 | 35NHG01B-400 | 25 | 450R11-660 | 13 |
| 250NHM1BI | 28 | 315NHM2BI-690 | 28 | 35NHG01BI | 26 | 450R12-660 | 13 |
| 250NHM1BS-690 | 30 | 315NHM2BS-690 | 30 | 35NHG01BI-400 | 25 | 450R20 | 14 |
| 250NHM2B-690 | 28 | 315NHM3B-690 | 28 | 35NHG02B | 26 | 450R40 | 14 |
| 250NHM2BI-690 | 28 | 315NHM3BI-690 | 28 | 35NHG02B-400 | 25 | 450RJ31-7 | 17 |
| 250NHM2BS-690 | 30 | 32BS | 19 | 35NHG02BI | 26 | 45KR85 | 16 |
| 25D16 | 37 | 32BSC | 19 | 35NHG02BI-400 | 25 | 45NH00AD | 23 |
| 25D27 | 37 | 32CML | 19 | 35NHG0B | 26 | 4D16 | 37 |
| 25GD27 | 38 | 32CMLC | 19 | 35NHG0B-690 | 27 | 4D27 | 37 |
| 25GN02 | 36 | 32H07-660 | 12 | 35NHM000B-690 | 28 | 4GD27 | 38 |
| 25H07-660 | 12 | 32HS07 | 11 | 35NHM000BI-690 | 28 | 4GN01 | 36 |
| 25HS07 | 11 | 32K08-660 | 13 | 35NHM0B | 28 | 4H07-660 | 12 |
| 25KR85 | 16 | 32K09-660 | 13 | 35NZ02 | 35 | 4K08-660 | 13 |
| 25KS09 | 11 | 32KS09 | 11 | 400EF | 19 | 4K09-660 | 13 |
| 25MJ31-8 | 17 | 32LSC | 19 | 400NH2M | 29 | 4NHC00M | 29 |
| 25NHC00M | 29 | 32LSCC | 19 | 400NH3M | 29 | 4NHG000B | 26 |
| 25NHG000B | 26 | 32MJ25-6 | 16 | 400NHG03B | 26 | 4NHG000B-400 | 25 |
| 25NHG000B-400 | 25 | 32MJ30-8 | 17 | 400NHG03B-400 | 25 | 4NHG000B-690 | 27 |
| 25NHG000B-690 | 27 | 32MJ31-8 | 17 | 400NHG03BI | 26 | 4NHG000BI | 26 |
| 25NHG000BI | 26 | 32NH0M | 29 | 400NHG03BI-400 | 25 | 4NHG000BI-400 | 25 |
| 25NHG000BI-400 | 25 | 32NHC00M | 29 | 400NHG2B | 26 | 4NHG000BI-690 | 27 |
| 25NHG000BI-690 | 27 | 32NHG000B | 26 | 400NHG2B-400 | 25 | 4NZ01 | 35 |

Index

| Catalogue Number | Page | Catalogue Number | Page | Catalogue Number | Page | Catalogue Number | Page |
|------------------|------|------------------|------|------------------|------|------------------|------|
| 500NH3M | 29 | 630NHG3BI | 26 | 6NHG0B-690 | 27 | AC4 | 8 |
| 500NH4G-S | 30 | 630NHG3BI-400 | 25 | 6NHM000B-690 | 28 | AC6 | 8 |
| 500NHG3B | 26 | 630NHG3BS-690 | 30 | 6NHM000BI-690 | 28 | AD10 | 8 |
| 500NHG3B-400 | 25 | 630NHG4G | 26 | 6NHM0B | 28 | AD16 | 8 |
| 500NHG3B-690 | 27 | 630NHM3B | 28 | 6NZ01 | 35 | AD2 | 8 |
| 500NHG3BI | 26 | 630NHM3BI | 28 | 70KR85 | 16 | AD20 | 8 |
| 500NHG3BI-400 | 25 | 630NHM3BS-690 | 30 | 710S20 | 14 | AD25 | 8 |
| 500NHG3BI-690 | 27 | 630R11-660 | 13 | 800NH4AG | 26 | AD32 | 8 |
| 500NHG3BS-690 | 30 | 630R12-660 | 13 | 800NH4G-S | 30 | AD4 | 8 |
| 500NHG4G | 26 | 630R20 | 14 | 800NHG4G | 26 | AD6 | 8 |
| 500NHM3B-690 | 28 | 630SJ31-6 | 17 | 800S20 | 14 | BAO35 | 6 |
| 500NHM3BI-690 | 28 | 63D33 | 37 | 800SJ28 | 17 | BAO40 | 6 |
| 500NHM3BS-690 | 30 | 63ENL | 20 | 80D125 | 37 | BAO50 | 6 |
| 500R11-660 | 13 | 63ENSBS | 20 | 80KR85 | 16 | BAO63 | 6 |
| 500R12-660 | 13 | 63ENSF | 20 | 80L09-660 | 13 | BAO63M100 | 6 |
| 500R20 | 14 | 63ENSFBS | 20 | 80L14-660 | 12 | BAO63M80 | 6 |
| 500R40 | 14 | 63GD33 | 38 | 80LR85 | 16 | BC0 | 32 |
| 500RJ31-7 | 17 | 63K07-660 | 12 | 80MJ25-6 | 16 | BC00 | 32 |
| 50D33 | 37 | 63K08-660 | 13 | 80MJ29-6 | 17 | BC1-2 | 32 |
| 50GD33 | 38 | 63K09-660 | 13 | 80MJ30-7 | 17 | BC3 | 32 |
| 50GN02 | 36 | 63KS07 | 11 | 80MJ31-7 | 17 | BC40 | 8 |
| 50K07-660 | 12 | 63KS08 | 11 | 80NH00M | 29 | BC50 | 8 |
| 50K08-660 | 13 | 63KS09 | 11 | 80NH0M | 29 | BC63 | 8 |
| 50K09-660 | 13 | 63MJ25-6 | 16 | 80NH1M | 29 | BC63M100 | 8 |
| 50KR85 | 16 | 63MJ29-6 | 17 | 80NHG000B | 26 | BC63M80 | 8 |
| 50KS07 | 11 | 63MJ30-8 | 17 | 80NHG000B-400 | 25 | BD40 | 8 |
| 50KS08 | 11 | 63MJ31-8 | 17 | 80NHG000BI | 26 | BD50 | 8 |
| 50KS09 | 11 | 63NH00M | 29 | 80NHG000BI-400 | 25 | BD63 | 8 |
| 50LR85 | 16 | 63NH0M | 29 | 80NHG00B-690 | 27 | BFD1-31/LL | 40 |
| 50MJ30-8 | 17 | 63NH1M | 29 | 80NHG00BI-690 | 27 | BFD1-31/LM | 40 |
| 50MJ31-8 | 17 | 63NHG000B | 26 | 80NHG01B | 26 | BFD1-31/LW | 40 |
| 50NH0M | 29 | 63NHG000B-400 | 25 | 80NHG01B-40 | 25 | BFD1-33/LL | 40 |
| 50NH1M | 29 | 63NHG000BI | 26 | 80NHG01BI | 26 | BFD1-33/LM | 40 |
| 50NHC00M | 29 | 63NHG000BI-400 | 25 | 80NHG01BI-400 | 25 | BFD1-33/LW | 40 |
| 50NHG000B | 26 | 63NHG00B-690 | 27 | 80NHG02B | 26 | BFD2-31/LL | 40 |
| 50NHG000B-400 | 25 | 63NHG00BI-690 | 27 | 80NHG02B-400 | 25 | BFD2-31/LM | 40 |
| 50NHG000BI | 26 | 63NHG01B | 26 | 80NHG02BI | 26 | BFD2-31/LW | 40 |
| 50NHG000BI-400 | 25 | 63NHG01B-400 | 25 | 80NHG02BI-400 | 25 | BFD2-33/LL | 40 |
| 50NHG00B-690 | 27 | 63NHG01BI | 26 | 80NHG0B | 26 | BFD2-33/LM | 40 |
| 50NHG00BI-690 | 27 | 63NHG01BI-400 | 25 | 80NHG0B-690 | 27 | BFD2-33/LW | 40 |
| 50NHG01B | 26 | 63NHG02B | 26 | 80NHG1B-690 | 27 | BFD3-31/LL | 40 |
| 50NHG01B-400 | 25 | 63NHG02B-400 | 25 | 80NHG1BI-690 | 27 | BFD3-31/LM | 40 |
| 50NHG01BI | 26 | 63NHG02BI | 26 | 80NHG1BS-690 | 30 | BFD3-31/LW | 40 |
| 50NHG01BI-400 | 25 | 63NHG02BI-400 | 25 | 80NHG2B-690 | 27 | BFD3-33/LL | 40 |
| 50NHG02B | 26 | 63NHG0B | 26 | 80NHG2BI-690 | 27 | BFD3-33/LM | 40 |
| 50NHG02B-400 | 25 | 63NHG0B-690 | 27 | 80NHM00B | 28 | BFD3-33/LW | 40 |
| 50NHG02BI | 26 | 63NHG1B-690 | 27 | 80NHM00BI | 28 | BFH000-1A/T | 41 |
| 50NHG02BI-400 | 25 | 63NHG1BI-690 | 27 | 80NHM0B | 28 | BFH000-3A/T | 41 |
| 50NHG0B | 26 | 63NHG1BS-690 | 30 | 80NHM1B | 28 | BFH00-1A/F | 41 |
| 50NHG0B-690 | 27 | 63NHG2B-690 | 27 | 80NHM1BI | 28 | BFH00-3A/F | 41 |
| 50NHG1B-690 | 27 | 63NHG2BI-690 | 27 | 80NHM1BS-690 | 30 | BFH1-1A/F | 41 |
| 50NHG1BI-690 | 27 | 63NHM00B | 28 | 80NZ03 | 35 | BFH1-3A/F | 41 |
| 50NHM00B | 28 | 63NHM00BI | 28 | 900NH4AG | 26 | BFH2-1A/F | 41 |
| 50NHM00BI | 28 | 63NHM0B | 28 | 90KR85 | 16 | BFH2-3A/F | 41 |
| 50NHM0B | 28 | 63NHM1B-690 | 28 | 90NH00AD | 23 | BFH3-1A/F | 41 |
| 50NZ02 | 35 | 63NHM1BI-690 | 28 | AAO10 | 5 | BFH3-3A/F | 41 |
| 560R11-660 | 13 | 63NHM1BS-690 | 30 | AAO16 | 5 | BFR1-3K/LL | 39 |
| 560R12-660 | 13 | 63NZ02 | 35 | AAO2 | 5 | BFR1-3K/LM/C | 39 |
| 560R20 | 14 | 6D16 | 37 | AAO20 | 5 | BFR1-3K/LW | 39 |
| 560SJ31-6 | 17 | 6D27 | 37 | AAO25 | 5 | BFR2-3K/LL | 39 |
| 5KR85 | 16 | 6GD27 | 38 | AAO32 | 5 | BFR2-3K/LM/C | 39 |
| 60KR85 | 16 | 6GN01 | 36 | AAO32M40 | 5 | BFR2-3K/LW | 39 |
| 60LR85 | 16 | 6H07-660 | 12 | AAO32M50 | 5 | BFR3-3K/LL | 39 |
| 60NH00AD | 23 | 6K08-660 | 13 | AAO32M63 | 5 | BFR3-3K/LM/C | 39 |
| 63/100BS | 19 | 6K09-660 | 13 | AAO4 | 5 | BFR3-3K/LW | 39 |
| 63/100CML | 19 | 6NHC00M | 29 | AAO6 | 5 | C08G0.5 | 21 |
| 63/100LSC | 19 | 6NHG000B | 26 | AC10 | 8 | C08G1 | 21 |
| 630NH3M | 29 | 6NHG000B-400 | 25 | AC16 | 8 | C08G10 | 21 |
| 630NH4AG | 26 | 6NHG000B-690 | 27 | AC2 | 8 | C08G10I | 21 |
| 630NH4G-S | 30 | 6NHG000BI | 26 | AC20 | 8 | C08G12 | 21 |
| 630NHG3B | 26 | 6NHG000BI-400 | 25 | AC25 | 8 | C08G12I | 21 |
| 630NHG3B-400 | 25 | 6NHG000BI-690 | 27 | AC32 | 8 | C08G16 | 21 |

Index

| Catalogue Number | Page | Catalogue Number | Page | Catalogue Number | Page | Catalogue Number | Page |
|------------------|------|------------------|------|------------------|------|------------------|------|
| C08G16I | 21 | C14G20I | 21 | C180-2A | 4 | C22M32 | 22 |
| C08G2 | 21 | C14G20S | 21 | C180-3A | 4 | C22M32I | 22 |
| C08G20 | 21 | C14G25 | 21 | C180-5A | 4 | C22M32S | 22 |
| C08G20I | 21 | C14G25I | 21 | C180-7A | 4 | C22M4 | 22 |
| C08G25 | 21 | C14G25S | 21 | C22G10 | 21 | C22M40 | 22 |
| C08G25I | 21 | C14G2I | 21 | C22G100 | 21 | C22M40I | 22 |
| C08G2I | 21 | C14G2S | 21 | C22G100I | 21 | C22M40S | 22 |
| C08G4 | 21 | C14G32 | 21 | C22G100S | 21 | C22M4I | 22 |
| C08G4I | 21 | C14G32I | 21 | C22G10I | 21 | C22M50 | 22 |
| C08G6 | 21 | C14G32S | 21 | C22G10S | 21 | C22M50I | 22 |
| C08G6I | 21 | C14G4 | 21 | C22G12 | 21 | C22M50S | 22 |
| C08G8 | 21 | C14G40 | 21 | C22G12S | 21 | C22M6 | 22 |
| C08G8I | 21 | C14G40I | 21 | C22G125I | 21 | C22M63 | 22 |
| C10G0.5 | 21 | C14G40S | 21 | C22G125S | 21 | C22M63I | 22 |
| C10G1 | 21 | C14G45S | 21 | C22G12I | 21 | C22M63S | 22 |
| C10G10 | 21 | C14G4I | 21 | C22G12S | 21 | C22M6I | 22 |
| C10G10I | 21 | C14G4S | 21 | C22G16 | 21 | C22M8 | 22 |
| C10G12 | 21 | C14G50 | 21 | C22G16I | 21 | C22M80 | 22 |
| C10G12I | 21 | C14G50I | 21 | C22G16S | 21 | C22M80I | 22 |
| C10G16 | 21 | C14G50S | 21 | C22G2 | 21 | C22M80S | 22 |
| C10G16I | 21 | C14G6 | 21 | C22G20 | 21 | C22M8I | 22 |
| C10G2 | 21 | C14G6I | 21 | C22G20I | 21 | C22NL | 22 |
| C10G20 | 21 | C14G6S | 21 | C22G20S | 21 | C3030 | 4 |
| C10G20I | 21 | C14G8 | 21 | C22G25 | 21 | C4545 | 4 |
| C10G25 | 21 | C14G8I | 21 | C22G25I | 21 | C55 | 4 |
| C10G25I | 21 | C14G8S | 21 | C22G25S | 21 | C8M10 | 22 |
| C10G2I | 21 | C14M0.25 | 22 | C22G2I | 21 | C8M10I | 22 |
| C10G32 | 21 | C14M0.50 | 22 | C22G32 | 21 | C8M12 | 22 |
| C10G32I | 21 | C14M1 | 22 | C22G32I | 21 | C8M12I | 22 |
| C10G4 | 21 | C14M10 | 22 | C22G32S | 21 | C8M16 | 22 |
| C10G4I | 21 | C14M10I | 22 | C22G4 | 21 | C8M16I | 22 |
| C10G6 | 21 | C14M10S | 22 | C22G40 | 21 | C8M2 | 22 |
| C10G6I | 21 | C14M12 | 22 | C22G40I | 21 | C8M20 | 22 |
| C10G8 | 21 | C14M12I | 22 | C22G40S | 21 | C8M20I | 22 |
| C10G8I | 21 | C14M12S | 22 | C22G4I | 21 | C8M25 | 22 |
| C10M0.16 | 22 | C14M16 | 22 | C22G4S | 21 | C8M2I | 22 |
| C10M0.25 | 22 | C14M16I | 22 | C22G50 | 21 | C8M4 | 22 |
| C10M0.5 | 22 | C14M16S | 22 | C22G50I | 21 | C8M4I | 22 |
| C10M1 | 22 | C14M1I | 22 | C22G50S | 21 | C8M6 | 22 |
| C10M10 | 22 | C14M2 | 22 | C22G6 | 21 | C8M6I | 22 |
| C10M10I | 22 | C14M20 | 22 | C22G63 | 21 | C8M8 | 22 |
| C10M12 | 22 | C14M20I | 22 | C22G63I | 21 | C8NL | 22 |
| C10M12I | 22 | C14M20S | 22 | C22G63S | 21 | CA10D15 | 23 |
| C10M16 | 22 | C14M25 | 22 | C22G6I | 21 | CA14D30 | 23 |
| C10M16I | 22 | C14M25I | 22 | C22G6S | 21 | CA22D15 | 23 |
| C10M1I | 22 | C14M25S | 22 | C22G8 | 21 | CA22D30 | 23 |
| C10M2 | 22 | C14M2I | 22 | C22G80 | 21 | CA22D45 | 23 |
| C10M20 | 22 | C14M2S | 22 | C22G80I | 21 | CA22D60 | 23 |
| C10M20I | 22 | C14M32 | 22 | C22G80S | 21 | CD0623G2 | 22 |
| C10M25 | 22 | C14M32I | 22 | C22G8I | 21 | CD0623G4 | 22 |
| C10M25I | 22 | C14M32S | 22 | C22G8S | 21 | CD0623G6 | 22 |
| C10M2I | 22 | C14M4 | 22 | C22M10 | 22 | CD0823G10 | 22 |
| C10M32 | 22 | C14M40 | 22 | C22M100 | 22 | CD0823G10I | 22 |
| C10M32I | 22 | C14M40I | 22 | C22M100I | 22 | CD0823G16 | 22 |
| C10M4 | 22 | C14M40S | 22 | C22M100S | 22 | CD0823G16I | 22 |
| C10M4I | 22 | C14M4I | 22 | C22M10I | 22 | CD0823G2 | 22 |
| C10M6 | 22 | C14M4S | 22 | C22M12 | 22 | CD0823G2I | 22 |
| C10M6I | 22 | C14M50 | 22 | C22M125 | 22 | CD0823G4 | 22 |
| C10M8 | 22 | C14M50I | 22 | C22M125I | 22 | CD0823G4I | 22 |
| C10M8I | 22 | C14M50S | 22 | C22M125S | 22 | CD0823G6 | 22 |
| C10NL | 22 | C14M6 | 22 | C22M12I | 22 | CD0823G6I | 22 |
| C14G10 | 21 | C14M6I | 22 | C22M16 | 22 | CD0831G0.5 | 22 |
| C14G10I | 21 | C14M6S | 22 | C22M16I | 22 | CD0831G1 | 22 |
| C14G10S | 21 | C14M8 | 22 | C22M16S | 22 | CD0831G10 | 22 |
| C14G12 | 21 | C14M8I | 22 | C22M2 | 22 | CD0831G10I | 22 |
| C14G12I | 21 | C14M8S | 22 | C22M20 | 22 | CD0831G12 | 22 |
| C14G12S | 21 | C14NL | 22 | C22M20I | 22 | CD0831G12I | 22 |
| C14G16 | 21 | C1515 | 4 | C22M20S | 22 | CD0831G16 | 22 |
| C14G16I | 21 | C1520 | 4 | C22M25 | 22 | CD0831G2 | 22 |
| c14G16S | 21 | C180-10A | 4 | C22M25I | 22 | CD0831G20 | 22 |
| C14G2 | 21 | C180-13A | 4 | C22M25S | 22 | CD0831G20I | 22 |
| C14G20 | 21 | C180-1A | 4 | C22M2I | 22 | CD0831G25 | 22 |

Index

| Catalogue Number | Page | Catalogue Number | Page | Catalogue Number | Page | Catalogue Number | Page |
|------------------|------|------------------|------|------------------|------|------------------|------|
| CD0831G25I | 22 | CH141DI | 24 | ED250 | 8 | M-CEO100 | 11 |
| CD0831G2I | 22 | CH141DMS | 24 | ED315 | 8 | M-CEO80 | 11 |
| CD0831G4 | 22 | CH141DMS-F | 24 | ED315M400 | 8 | M-CM100F | 11 |
| CD0831G4I | 22 | CH141DN | 24 | ED355 | 8 | M-CM20F | 11 |
| CD0831G6 | 22 | CH141DNI | 24 | ED400 | 8 | M-CM32F | 11 |
| CD0831G6I | 22 | CH141DNX | 24 | ED400M500 | 8 | M-CM32FC | 11 |
| CD0831G8 | 22 | CH142D | 24 | EF355 | 9 | M-CM63F | 11 |
| CD0836G10 | 22 | CH142DI | 24 | EF400 | 9 | M-NITD10 | 11 |
| CD0836G10I | 22 | CH143D | 24 | EF400M500 | 9 | M-NITD16 | 11 |
| CD0836G16 | 22 | CH143DI | 24 | EFS125 | 9 | M-NITD2 | 11 |
| CD0836G16I | 22 | CH143DMS | 24 | EFS160 | 9 | M-NITD20 | 11 |
| CD0836G2 | 22 | CH143DMS-F | 24 | EFS200 | 9 | M-NITD32 | 11 |
| CD0836G20 | 22 | CH143DN | 24 | EFS250 | 9 | M-NITD6 | 11 |
| CD0836G20I | 22 | CH143DNI | 24 | EFS315 | 9 | M-NSD10 | 11 |
| CD0836G25 | 22 | CH143DNMS | 24 | ESD10 | 10 | M-NSD16 | 11 |
| CD0836G25I | 22 | CH143DNMS-F | 24 | ESD16 | 10 | M-NSD20 | 11 |
| CD0836G2I | 22 | CH144D | 24 | ESD2 | 10 | M-NSD32 | 11 |
| CD0836G32 | 22 | CH144DI | 24 | ESD20 | 10 | M-NSD4 | 11 |
| CD0836G32I | 22 | CH14-HP | 24 | ESD32 | 10 | M-NSD6 | 11 |
| CD0836G4 | 22 | CH14MS-1D | 24 | ESD4 | 10 | M-STD10 | 11 |
| CD0836G4I | 22 | CH14MS-3D | 24 | ESD40 | 10 | M-STD6 | 11 |
| CD0836G6 | 22 | CH221D | 24 | ESD50 | 10 | NI | 19 |
| CD0836G6I | 22 | CH221DMS | 24 | ESD6 | 10 | NITD10 | 5 |
| CD100 | 8 | CH221DN | 24 | ESD63 | 10 | NITD16 | 5 |
| CD100M125 | 8 | CH221DNX | 24 | ESD63M100 | 10 | NITD2 | 5 |
| CD100M160 | 8 | CH222D | 24 | ESD63M80 | 10 | NITD20 | 5 |
| CD100M200 | 8 | CH223D | 24 | FC0 | 32 | NITD20M25 | 5 |
| CD1025G10 | 22 | CH223DMS | 24 | FC00 | 32 | NITD20M32 | 5 |
| CD1025G10I | 22 | CH223DN | 24 | FC1 | 32 | NITD25 | 5 |
| CD1025G16 | 22 | CH224D | 24 | FC2 | 32 | NITD32 | 5 |
| CD1025G16I | 22 | CH22MDNMS | 24 | FC3 | 32 | NITD32M40 | 5 |
| CD1025G6 | 22 | CH810-HP | 23 | FEH | 32 | NITD32M50 | 5 |
| CD1025G6I | 22 | CHM1D | 23 | FF400 | 9 | NITD32M63 | 5 |
| CD1031G16 | 22 | CHM1DI | 23 | FF500 | 9 | NITD4 | 5 |
| CD1031G16I | 22 | CHM1DN | 23 | FF560 | 9 | NITD6 | 5 |
| CD1031G20 | 22 | CHM1DNI | 23 | FF630 | 9 | NSD10 | 10 |
| CD1031G20I | 22 | CHM1DNS | 23 | FG450 | 9 | NSD16 | 10 |
| CD1031G25 | 22 | CHM1DNSI | 23 | FG500 | 9 | NSD2 | 10 |
| CD1031G25I | 22 | CHM2D | 23 | FG560 | 9 | NSD20 | 10 |
| CD1038G25 | 22 | CHM2DI | 23 | FG630 | 9 | NSD20M25 | 10 |
| CD1038G25I | 22 | CHM3D | 23 | FN01C | 36 | NSD20M32 | 10 |
| CD1038G32 | 22 | CHM3DI | 23 | FN02C | 36 | NSD20M36 | 10 |
| CD1038G32I | 22 | CHM3DN | 23 | FRN01C | 36 | NSD32 | 10 |
| CD27 | 38 | CHM3DNI | 23 | FRN02C | 36 | NSD32M36 | 10 |
| CD33 | 38 | CHM3DNS | 23 | GF1000 | 9 | NSD32M40 | 10 |
| CD80 | 8 | CHM3DNSI | 23 | GF1250 | 9 | NSD32M50 | 10 |
| CEO100 | 6 | CHM4D | 23 | GF710 | 9 | NSD32M63 | 10 |
| CEO100M125 | 6 | CHM4DI | 23 | GF800 | 9 | NSD4 | 10 |
| CEO100M160 | 6 | CHMDNX | 23 | GG1000 | 9 | NSD6 | 10 |
| CEO100M200 | 6 | CM100F | 19 | GG1250 | 9 | OSD100 | 7 |
| CEO32 | 6 | CM20F | 19 | GG710 | 9 | OSD100M125 | 7 |
| CEO40 | 6 | CM32F | 19 | GG800 | 9 | OSD100M160 | 7 |
| CEO50 | 6 | CM32FC | 19 | GH1000 | 9 | OSD80 | 7 |
| CEO63 | 6 | CM63F | 19 | GH1250 | 9 | SB00-D | 32 |
| CEO80 | 6 | CMSC | 19 | GH710 | 9 | SB0-D | 32 |
| CH081D | 23 | CN01 | 36 | GH800 | 9 | SB0-DMS | 32 |
| CH081DI | 23 | CN02 | 36 | GLP | 19 | SB1-D | 32 |
| CH081DN | 23 | CS0 | 32 | LBS4/1 | 41 | SB1-DMS | 32 |
| CH081DNI | 23 | CS00 | 32 | LBS4/3 | 41 | SB2-D | 32 |
| CH081DNS | 23 | CS1 | 32 | M-32NNSF | 11 | SB2-DMS | 32 |
| CH081DNSI | 23 | CS2 | 32 | M-63ENSF | 11 | SB3-D | 32 |
| CH082D | 23 | CS3 | 32 | M-AAO10 | 11 | SB3-DMS | 32 |
| CH082DI | 23 | DD125 | 8 | M-AAO16 | 11 | SB4-DMS | 32 |
| CH083D | 23 | DD160 | 8 | M-AAO20 | 11 | SB4-S | 32 |
| CH083DI | 23 | DD200 | 8 | M-AAO25 | 11 | SFD27 | 38 |
| CH083DN | 23 | DD200M250 | 8 | M-BAO40 | 11 | SFD33 | 38 |
| CH083DNI | 23 | DD200M315 | 8 | M-BAO50 | 11 | SFPCDO1 | 36 |
| CH083DNS | 23 | DEO125 | 7 | M-BAO63 | 11 | SFPCDO2 | 36 |
| CH083DNSI | 23 | DEO160 | 7 | M-C180-13A | 11 | SFPRD27 | 38 |
| CH084D | 23 | DEO200 | 7 | M-C180-3A | 11 | SFPRD33 | 38 |
| CH084DI | 23 | DEO200M250 | 7 | M-C180-5A | 11 | SFRD27 | 38 |
| CH141D | 24 | DEO200M315 | 7 | M-CD100 | 11 | SFRD33 | 38 |

Cooper Bussmann® Products and Technical Support Delivered Worldwide

Customer Assistance

Customer Satisfaction Team

The Cooper Bussmann® Customer Satisfaction Team is available to answer questions regarding Cooper Bussmann® products and services.

Contact should be made between:
Monday to Friday: 7:30am to 5:30pm GMT

The Customer Satisfaction Team can be reached via:

- Phone: 00 44 (0) 1509 882 600
- Fax: 00 44 (0) 1509 882 786
- Email: sales@cooperbussmann.co.uk

Application Engineering

Application Engineering assistance is available to all customers. The Application Engineering team is staffed by degreed electrical engineers and available by phone with technical and application support Monday to Friday: 7:30am to 5:30pm GMT.

Application Engineering can be reached via:

- Phone: 00 44 (0) 1509 882 699
- Fax: 00 44 (0) 1509 882 794
- Email: technical@cooperbussmann.co.uk

Web Services

www.cooperbussmann.com

The Cooper Bussmann® website makes available free information and other resources that include:

- Product Data Sheets for complete technical information on Cooper Bussmann® products
- Online catalogue for the latest United States and European catalogues
- Safety BASCIS™ for the essentials of electrical safety
- Training modules for increasing skill levels of customers and end users
- Fuse Cross-reference to find the correct Cooper Bussmann® replacement for a competitive fuse
- Arc-Flash calculator to determine the incident energy level and flash protection boundary along with the recommendations the level of Personal Protective Equipment (PPE)

Your authorised Cooper Bussmann® Distributor is:



Cooper Bussmann (UK) Ltd ● Burton-on-the-Wolds, Loughborough ●
Leicestershire LE12 5TH, UK
Tel: 00 44 (0) 1509 882 600 ● Fax: 00 44 (0) 1509 882 786
Email: sales@cooperbussmann.co.uk ● Website: www.cooperbussmann.com



Reorder: LV-2007