

**Total Power Solution for Portable Applications**

## General Description

The AAT3601 is a member of AnalogicTech's Total Power Management IC™ (TPMIC™) product family. It contains a single-cell Lithium Ion/Polymer battery charger, a fully integrated step-down converter and 5 low dropout (LDO) regulators. The device also includes 2 load switches for dynamic power path/sleep mode operation, making it ideal for small portable short-range communications enabled mobile devices and telephones.

The battery charger is a complete thermally regulated constant current/constant voltage linear charger. It includes an integrated pass device, reverse blocking protection, high accuracy current and voltage regulation, charge status, and charge termination. The charging current and the charge termination current as well as recharge voltage are programmable with either an external resistor and/or by a standard I<sup>2</sup>C interface.

The step-down DC/DC converter is integrated with internal compensation and operates at a switching frequency of 1.5MHz, thus minimizing the size of external components while keeping switching losses low and efficiency greater than 95%. All LDO output voltages are programmable using the I<sup>2</sup>C interface.

The five LDOs offer 60dB power supply rejection ratio (PSRR) and low noise operation making them suitable for powering noise-sensitive loads. The LDOs and DC/DC converter are separated into Permanent-Enabled (PE) and Non-Permanent (NP) enabled supplies.

All six voltage regulators operate with low quiescent current. The total no load current when the 3 PE LDOs are enabled is only 200µA.

The device includes a watchdog timer input and two reset outputs for the watchdog and LDO regulation. The device also can be programmed through a standard I<sup>2</sup>C interface.

The AAT3601 is available in a thermally enhanced low profile 5x5x0.8mm 36-pin TQFN package.

## Features

- Voltage Regulator  $V_{IN}$  Range: 4.5V to 6V
- Complete Power Integration
  - Integrated Load Switches to Power Converters from AC Adapter or Battery Automatically
- Low Standby Current
  - 200µA (typ) w/LDO1, LDO2 and LDO5 Active, No Load
- One Step-Down Buck Converter (NP)
  - 1.24V, 300mA Output
  - 1.5MHz Switching Frequency
  - Fast Turn-On Time (120µs typ)
- Five LDOs Programmable by I<sup>2</sup>C
  - LDO1: 3.4V, 150mA (PE)
  - LDO2: 3.4V, 300mA (NP)
  - LDO3: 1.24V, 300mA (PE)
  - LDO4: 1.85V, 300mA (NP)
  - LDO5: 1.85V, 300mA (PE)
  - PSRR: 60dB @10kHz
  - Noise: 50µVrms
- One Battery Charger
  - Digitized Thermal Regulation
  - Charge Current Programming up to 1.4A
  - Charge Current Termination Programming
  - Automatic Trickle Charge for Battery Preconditioning (2.8V Cutoff)
- Watchdog (WDI) Timer Input
  - Two Reset ( $\overline{RSTIN}$ ,  $\overline{RSTLPW}$ ) Timer Outputs
- Separate Enable Pins for PE and NP Supplies
- Digital Programming of Major Parameters via I<sup>2</sup>C
- Over-Current Protection
- Over-Temperature Protection
- 5x5mm TQFN55-36 Package

## Applications

- Digital Cameras
- GSM or CDMA Cellular Phones
- Handheld Instruments
- PDAs and Handheld Computers
- Portable Media Players
- Short-Range Communication Headsets

## Typical Application

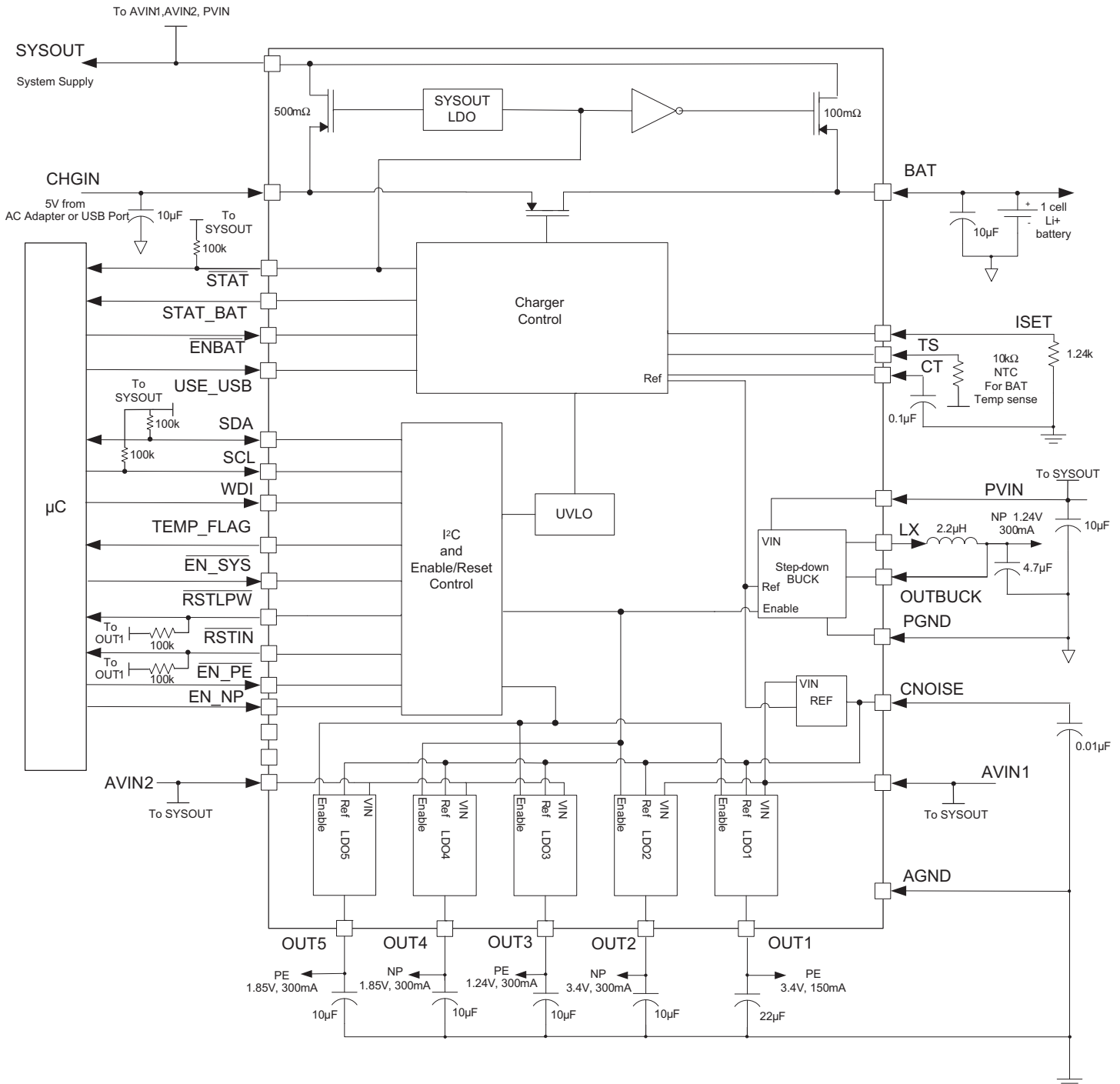

**Total Power Solution for Portable Applications**
**Pin Descriptions**

Pin #	Symbol	Function
1	WDI	Watchdog timer input. Clock input from processor. If no clock input is detected for 60ms, it will reset RSTIN.
2	$\overline{\text{TEMP\_FLAG}}$	Open drain output which pulls low when an over temperature shutdown occurs in the regulator or the charger and when the thermal loop in the charger is activated.
3	$\overline{\text{EN\_SYS}}$	Active Low Enable for the system. An internal pull-up resistor (150k $\Omega$ ) keeps the pin pulled up to an internal supply to keep the system off when there is no CHGIN input. Connect a normally-open pushbutton switch from this pin to GND. To filter noise internally, there is an internal 100 $\mu$ s debounce delay circuit.
4	STAT_BAT	Open Drain Output for Battery Charger Status. Same function as $\overline{\text{STAT}}$ pin but with opposite polarity.
5	$\overline{\text{EN\_PE}}$	Active Low Enable for Permanently-Enabled Supplies: LDO1, LDO3, and LDO5. (This pin is internally pulled low with 250nA)
6	EN_NP	Active High Enable for Non-Permanent Supplies: Buck, LDO2, and LDO4 (This pin is internally pulled low with 250nA)
7	SGND	Signal ground
8	SGND	Signal ground
9	OUT5	Output for LDO5 (when disabled, this pin is pulled down with 10k $\Omega$ )
10	OUT4	Output for LDO4 (when disabled, this pin is pulled down with 10k $\Omega$ )
11	AVIN2	Analog voltage input. Must be tied to SYSOUT on the PCB.
12	OUT3	Output for LDO3 (when disabled, this pin is pulled down with 10k $\Omega$ )
13	OUT2	Output for LDO2 (when disabled, this pin is pulled down with 10k $\Omega$ )
14	AVIN1	Analog voltage input. Must be tied to SYSOUT on the PCB.
15	OUT1	Output for LDO1 (when disabled, this pin is pulled down with 10k $\Omega$ )
16	AGND	Signal ground
17	CNOISE	Noise Bypass pin for the internal reference voltage. Connect a 0.01 $\mu$ F capacitor to AGND.
18	$\overline{\text{RSTLPW}}$	Open Drain Reset output. Pulled low internally when any Permanent Supply (LDO1, LDO3, LDO5) are not in regulation. Releases High 800ms (typ) after all supplies are in regulation.
19	$\overline{\text{RSTIN}}$	Open Drain Reset output. Pulled low internally when any Non-Permanent Supply (Buck, LDO2, or LDO4) are not in regulation. Releases High 10ms (typ) after all supplies are in regulation.
20	LX	Step-down Buck converter switching node. Connect an inductor between this pin and the output.
21	PGND	Power Ground for step-down Buck converter.
22	PVIN	Input power for step-down Buck converter. Must be tied to SYSOUT.
23	OUTBUCK	Feedback input for the step-down Buck converter.
24, 25	SYSOUT	System Power output. Connect to the input voltage pins PIN, AVIN1/2 for the step-down converter and LDOs and other external supply requirements.
26, 27	BAT	Connect to a Lithium-Ion Battery.
28	CHGIN	Power input from either external Adapter or USB port.
29	USE_USB	When pulled high, fast charge current is set to 100mA regardless of the resistor value present on the ISET pin. Additionally, the CHGIN-SYSOUT LDO will be disabled and the BAT-SYSOUT load switch will be enabled.
30	$\overline{\text{ENBAT}}$	Active low enable for the battery charger (Internally pulled low when floating)
31	TS	Battery Temperature Sense pin with 75 $\mu$ A output current. Connect the battery's NTC resistor to this pin and ground.
32	ISET	Charge current programming input pin. Can be used to monitor charge current.
33	CT	Charger Safety Timer Pin. A 0.1 $\mu$ F ceramic capacitor should be connected between this pin and GND. Connect directly to GND to disable the timer function.
34	$\overline{\text{STAT}}$	Open drain output for battery charging status.
35	SDA	I <sup>2</sup> C serial Data pin, open drain; requires a pullup resistor.
36	SCL	I <sup>2</sup> C serial Clock pin, open drain; requires a pullup resistor.
EP	EP	The exposed thermal pad (EP) must be connected to board ground plane and pins 16 and 21. The ground plane should include a large exposed copper pad under the package for thermal dissipation (see package outline).

## Pin Configuration

**TQFN55-36  
(Top View)**

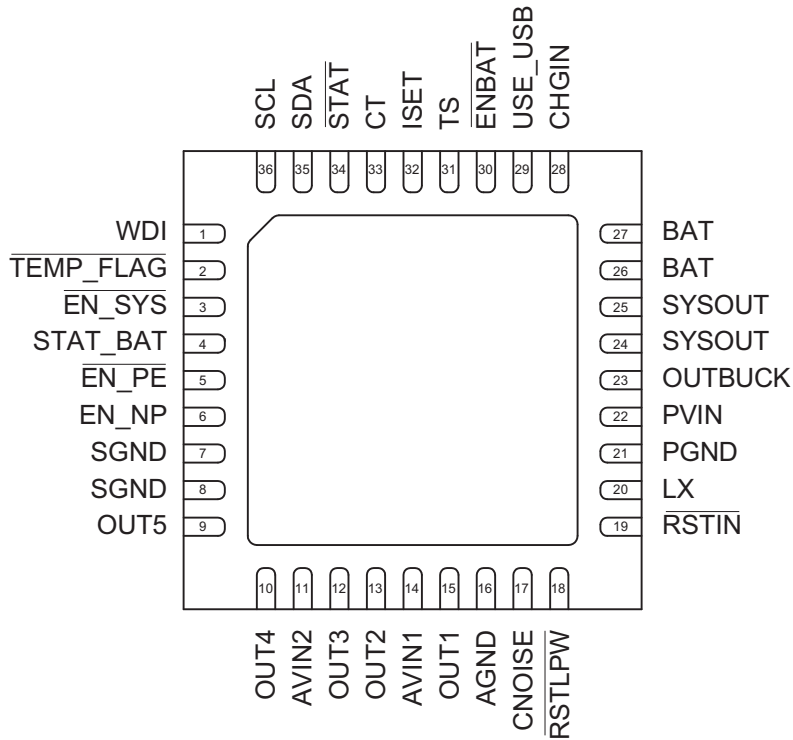

**Total Power Solution for Portable Applications**
**Absolute Maximum Ratings<sup>1</sup>**

$T_A = 25^\circ\text{C}$  unless otherwise noted.

Symbol	Description	Value	Units
$V_{IN}$	Input Voltage, CHGIN, BAT	-0.3 to 6.5	V
Power and Logic Pins	Maximum Rating	$V_{IN} + 0.3$	V
$T_J$	Operating Junction Temperature Range	-40 to 150	$^\circ\text{C}$
$T_S$	Storage Temperature Range	-65 to 150	$^\circ\text{C}$
$T_{LEAD}$	Maximum Soldering Temperature (at leads, 10 sec)	300	$^\circ\text{C}$

**Recommended Operating Conditions<sup>2</sup>**

Symbol	Description	Value	Units
$\theta_{JA}$	Thermal Resistance	25	$^\circ\text{C}/\text{W}$
$P_D$	Maximum Power Dissipation	4	W

1. Stresses above those listed in Absolute Maximum Ratings may cause permanent damage to the device. Functional operation at conditions other than the operating conditions specified is not implied. Only one Absolute Maximum Rating should be applied at any one time.
2. Thermal Resistance was measured with the AAT3601 device on the 4-layer FR4 evaluation board in a thermal oven. The amount of power dissipation which will cause the thermal shutdown to activate will depend on the ambient temperature and the PC board layout ability to dissipate the heat. See Figures 13-16.

**Total Power Solution for Portable Applications**
**Electrical Characteristics<sup>1</sup>**
 $V_{IN} = 5V$ ,  $V_{BAT} = 3.6V$ ,  $-40^{\circ}C \leq T_A \leq +85^{\circ}C$ , unless otherwise noted. Typical values are  $T_A = 25^{\circ}C$ .

Symbol	Description	Conditions	Min	Typ	Max	Units
<b>Power Supply</b>						
$V_{CHGIN}$	CHGIN Input Voltage		4.5		6	V
$I_Q$	Battery Standby current	LDO1 + LDO2 + LDO5, No Load		200		$\mu A$
$I_{SHDN}$	Battery Shutdown Current	EN_SYS, EN_PE = High, EN_NP = Low			10.0	$\mu A$
$UVLO$	Under-Voltage Lockout for CHGIN	CHGIN rising		4.25	4.5	V
		CHGIN falling		4.15		V
	Battery Under-Voltage Lockout	BAT rising		2.6		V
		BAT falling		2.35		V
$I_{BAT}$	Leakage Current from BAT Pin	$V_{BAT} = 4V$ , $V_{CHGIN} = 0V$		2	5	$\mu A$
<b>Reset Timers</b>						
$t_{RSTIN}$	Reset Timer for Non-Permanent Supplies	Buck, OUT2, and OUT4 in Regulation	5	10	15	ms
$t_{RSTLPW}$	Reset Timer for Permanent Supplies	OUT1, OUT3, and OUT5 in Regulation	600	800	1000	ms
$RESET_{THR}$	RESET Comparator Threshold	For Each Output Falling, Typical Hysteresis = 2.7%	88.3	91.3	94.3	% of typ
$t_{WDI}$	Watchdog Timeout Period		50		70	ms
$WDI_{PW}$	WDI Pulse Width		0.1			$\mu s$
$WDI_{THRL}$	WDI Input Threshold VIL				0.4	V
$WDI_{THRH}$	WDI Input Threshold VIH		1.2			V
$WDI_{LK}$	WDI Input Current	WDI = 0 or SYSOUT	-1		1	$\mu A$
<b>Charger Voltage Regulation</b>						
$V_{BAT\_REG}$	Output Charge Voltage Regulation	$0^{\circ}C \leq T_A \leq +70^{\circ}C$	4.158	4.200	4.242	V
$V_{MIN}$	Preconditioning Voltage Threshold	(No trickle charge option can be made available)	2.6	2.8	3.0	V
$V_{RCH}$	Battery Recharge Voltage Threshold	I <sup>2</sup> C Recharge Code = 00 (default)		4.00		V
		I <sup>2</sup> C Recharge Code = 01		4.05		V
		I <sup>2</sup> C Recharge Code = 10		4.10		V
		I <sup>2</sup> C Recharge Code = 11		4.15		V
<b>Charger Current Regulation</b>						
$I_{CH\_CC}$	Constant-Current Mode Charge Current	$R_{ISET} = 1.24k$ (for 0.8A), USE_USB = Low, I <sup>2</sup> C ISET code = 000, $V_{BAT} = 3.6V$ , $V_{CHGIN} = 5.0V$	720	800	880	mA
		USE_USB = High, I <sup>2</sup> C ISET code = 000, $V_{BAT} = 3.6V$	85	100	115	
$KI\_SET$	Charge Current Set Factor: $I_{CH\_CC}/I_{ISET}$	Constant-Current mode, $V_{BAT} = 3.6V$ $R_{ISET} = 1.24k\Omega$ ; USE_USB = Low		800		% $I_{CH\_CC}$
$I_{CH\_PRE}$	Preconditioning-Charge Current	I <sup>2</sup> C ISET code = 000, USE_USB = High		50		mA
$I_{CH\_TERM}$	Charge Termination Threshold Current	I <sup>2</sup> C Term code = 00 (default)		5		% $I_{CH\_CC}$
		I <sup>2</sup> C Term code = 01		10		
		I <sup>2</sup> C Term code = 10		15		
		I <sup>2</sup> C Term code = 11		20		

1. Specification over the  $-40^{\circ}C$  to  $+85^{\circ}C$  operating temperature range is assured by design, characterization and correlation with statistical process controls.

**Total Power Solution for Portable Applications**
**Electrical Characteristics<sup>1</sup>**
 $V_{IN} = 5V$ ,  $V_{BAT} = 3.6V$ ,  $-40^{\circ}C \leq T_A \leq +85^{\circ}C$ , unless otherwise noted. Typical values are  $T_A = 25^{\circ}C$ .

Symbol	Description	Conditions	Min	Typ	Max	Units
<b>Charging Devices</b>						
$R_{DS(ON)}$	Charging Transistor ON Resistance	$V_{IN} = 5V$		0.6	0.9	$\Omega$
<b>Logic Control / Protection</b>						
$V_{EN\_PE\ or\ EN\_NP}$	Input High Threshold		1.4			V
$V_{EN\_PE\ or\ EN\_NP}$	Input Low Threshold				0.4	V
$V_{STAT}$ , $V_{STAT\_BAT}$ , $V_{TEMP\_FLAG}$	Output Low Voltage	$I_{sink} = 4mA$			0.4	V
$I_{STAT}$ , $I_{STAT\_BAT}$ , $I_{TEMP\_FLAG}$	Output Pin Current Sink Capability				8	mA
$V_{OVP}$	Over Voltage Protection Threshold			4.3		V
$V_{OCP}$	Over Current Protection Threshold			105		$\%V_{CS}$
$T_C$	Constant Current Mode Time Out	$C_{CT} = 100nF$ , $V_{CHGIN} = 5V$		3		Hours
$T_K$	Trickle Charge Time Out			$T_C / 8$		Hours
$T_V$	Constant Voltage Mode Time Out			3		Hours
$I_{TS}$	Current Source from TS Pin			71	75	79
$TS_1$	TS Hot Temperature Fault	Falling Threshold	318	331	346	mV
		Hysteresis		25		
$TS_2$	TS Cold Temperature Fault	Rising Threshold	2.30	2.39	2.48	V
		Hysteresis		25		
$T_{LOOP\_IN}$	Thermal Loop Entering Threshold			115		$^{\circ}C$
$T_{LOOP\_OUT}$	Thermal Loop Exiting Threshold			85		$^{\circ}C$
$T_{REG}$	Thermal Loop Regulation			100		$^{\circ}C$
<b>Load Switches / SYSOUT LDO</b>						
$R_{DS(ON),BAT-SYSOUT}$	On Resistance of BAT-SYSOUT Load Switch	$V_{BAT} = 3.6V$		100	150	m $\Omega$
$R_{DS(ON),CHGIN-SYSOUT}$	On Resistance of CHGIN-SYSOUT Load Switch	$V_{CHGIN} = 4.5V$		0.5	0.75	$\Omega$
	SYSOUT LDO Input Voltage Range		4.5			V
	SYSOUT LDO Output Voltage	$I_{SYSOUT} < 900mA$ , $V_{CHGIN} = 4.5V\ to\ 6.0V$	3.4	3.9	4.2	V
$I_{SYSOUT}$	Output Current	$V_{CHGIN} = 5V$	1.5			A
<b>Step-Down Buck Converter</b>						
$V_{OUTBUCK}$	Output Voltage Accuracy	$I_{OUTBUCK} = 0\ to\ 300mA$ ; $V_{IN} = 2.7V\ to\ 5.5V$	1.203	1.24	1.277	V
	Buck Load Regulation	Load = 100 $\mu A$ to 300mA, $PV_{IN} = 3.6V$ , $V_{OUTBUCK} = 1.2V$		0.2		%
	Buck Ground Pin Current	No load		45		$\mu A$
$I_{LIMOUTBUCK}$	P-Channel Current Limit			0.8		A
$R_{DS(ON)L}$	High Side Switch On-Resistance			0.8		$\Omega$
$R_{DS(ON)H}$	Low Side Switch On-Resistance			0.8		$\Omega$
$F_{OSC}$	Oscillator Frequency	$T_A = 25^{\circ}C$		1.5		MHz
$T_S$	Start-Up Time	From Enable to Regulation; $C_{OUTBUCK} = 4.7\mu F$ , $C_{NOISE} = On$		100		$\mu s$

 1. Specification over the  $-40^{\circ}C$  to  $+85^{\circ}C$  operating temperature range is assured by design, characterization and correlation with statistical process controls.

**Total Power Solution for Portable Applications**
**Electrical Characteristics<sup>1</sup>**
 $V_{IN} = 5V$ ,  $V_{BAT} = 3.6V$ ,  $-40^{\circ}C \leq T_A \leq +85^{\circ}C$ , unless otherwise noted. Typical values are  $T_A = 25^{\circ}C$ .

Symbol	Description	Conditions	Min	Typ	Max	Units
<b>LDO1</b>						
$V_{OUT1}$	Output Voltage Accuracy	$I_{OUT1} = 0 \sim 150mA$ , $V_{AVINx}: 3.3V \sim 5.5V$	-3		+3	%
	LDO Ground Pin Current	For Each LDO With No Load		45		$\mu A$
$I_{OUT1}$	Output Current		150			mA
$I_{LIM1}$	Output Current Limit			1000		mA
$V_{DO1}$	Dropout Voltage	$I_{OUT1} = 150mA$		90	180	mV
$\frac{\Delta V_{OUT1}}{(V_{OUT1}\Delta V_{IN1})}$	Line Regulation	$I_{OUT1} = 100mA$ , $3.3V < V_{AVINx} < 5.5V$			0.07	%/V
$\Delta V_{OUT1}$	Load Regulation	$I_{OUT1} = 0.5mA \sim 150mA$		40		mV
PSRR	Power Supply Rejection Ratio	$I_{OUT1} = 10mA$ , $C_{OUT1} = 22\mu F$ , 100Hz $\sim$ 10KHz		60		dB
$T_s$	Start Up Time	From Enable to Regulation; $C_{OUT1} = 22\mu F$ , $C_{NOISE} = On$		3.5		ms
<b>LDO2</b>						
$V_{OUT2}$	Output Voltage Accuracy	$I_{OUT2} = 0 \sim 300mA$ , $V_{AVINx}: 3.3V \sim 5.5V$	-3		+3	%
$I_{OUT2}$	Output Current		300			mA
$I_{LIM2}$	Output Current Limit			1000		mA
$V_{DO2}$	Dropout Voltage	$I_{OUT2} = 150mA$		180		mV
$\frac{\Delta V_{OUT2}}{(V_{OUT2}\Delta V_{IN2})}$	Line Regulation	$I_{OUT2} = 100mA$ , $3.3V < V_{AVINx} < 5.5V$			0.07	%/V
$\Delta V_{OUT2}$	Load Regulation	Load: $0.5mA \sim 300mA$		40		mV
PSRR	Power Supply Rejection Ratio	$I_{OUT2} = 10mA$ , $C_{OUT2} = 10\mu F$ , 10 $\sim$ 10KHz		60		dB
$T_s$	Start Up Time	From Enable to Regulation; $C_{OUT2} = 10\mu F$ , $C_{NOISE} = On$		1.7		ms
<b>LDO3, LDO4, and LDO5</b>						
$V_{OUTx}$	Output Voltage Accuracy	$I_{OUTx} = 0 \sim 300mA$ , $V_{AVINx}: 3.3V \sim 5.5V$	-3		+3	%
$I_{OUTx}$	Output Current		300			mA
$I_{LIMx}$	Output Current Limit			1000		mA
$V_{DOx}$	Dropout Voltage	$I_{OUTx} = 150mA$		180		mV
$\frac{\Delta V_{OUTx}}{(V_{OUTx}\Delta V_{INx})}$	Line Regulation	$I_{OUTx} = 100mA$ , $3.3V < V_{AVINx} < 5.5V$			0.07	%/V
$\Delta V_{OUTx}$	Load Regulation	$I_{OUTx} = 0.5mA \sim 300mA$		40		mV
PSRR	Power Supply Rejection Ratio	$I_{OUTx} = 10mA$ , $C_{OUTx} = 10\mu F$ , 10 $\sim$ 10KHz		60		dB
$e_N$	Output Noise Voltage	$I_{OUTx} = 10mA$ , Power BW: 10kHz $\sim$ 100KHz		50		$\mu V_{rms}$
$T_s$	Start Up Time	From Enable to Regulation; $C_{OUTx} = 10\mu F$ , $C_{NOISE} = On$		1.2		ms
<b>Logic Control</b>						
$V_{IH}$	Enable Pin Logic High Level	EN_PE, EN_NP	1.4			V
$V_{IL}$	Enable Pin Logic Low Level				0.4	V
<b>Thermal</b>						
$T_{SD}$	Over Temperature Shutdown Threshold			140		$^{\circ}C$
$T_{HYS}$	Over Temperature Shutdown Hysteresis			15		$^{\circ}C$

 1. Specification over the  $-40^{\circ}C$  to  $+85^{\circ}C$  operating temperature range is assured by design, characterization and correlation with statistical process controls.



**Total Power Solution for Portable Applications**
**Electrical Characteristics<sup>1</sup>**

$V_{IN} = 5V$ ,  $V_{BAT} = 3.6V$ ,  $-40^{\circ}C \leq T_A \leq +85^{\circ}C$ , unless otherwise noted. Typical values are  $T_A = 25^{\circ}C$ .

Symbol	Description	Conditions	Min	Typ	Max	Units
<b>SCL, SDA (I<sup>2</sup>C interface)</b>						
$F_{SCL}$	Clock Frequency		0		400	KHz
$T_{LOW}$	Clock Low Period		1.3			$\mu s$
$T_{HIGH}$	Clock High Period		0.6			$\mu s$
$T_{HD\_STA}$	Hold Time START Condition		0.6			$\mu s$
$T_{SU\_STA}$	Setup Time for Repeat START		0.6			$\mu s$
$T_{SU\_DTA}$	Data Setup Time		100			ns
$T_{HD\_DAT}$	Data Hold Low		0		0.9	$\mu s$
$T_{SU\_STO}$	Setup Time for STOP Condition		0.6			$\mu s$
$T_{BUF}$	Bus Free Time Between STOP and START Condition		1.3			$\mu s$
$V_{IL}$	Input Threshold Low	$2.7V \leq V_{IN} \leq 5.5V$			0.4	V
$V_{IH}$	Input Threshold High	$2.7V \leq V_{IN} \leq 5.5V$	1.4			V
$I_i$	Input Current		-1.0		1.0	$\mu A$
$V_{OL}$	Output Logic Low (SDA)	$I_{PULLUP} = 3mA$			0.4	V

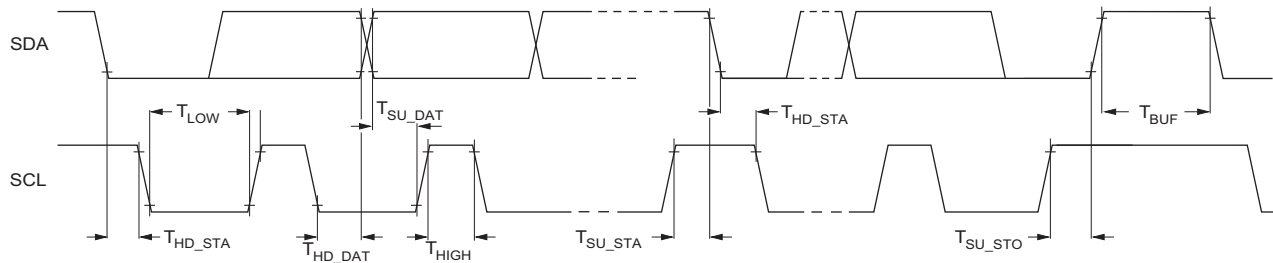
**Basic I<sup>2</sup>C Timing Diagram**

1. Specification over the  $-40^{\circ}C$  to  $+85^{\circ}C$  operating temperature range is assured by design, characterization and correlation with statistical process controls.

## Typical Characteristics – Charger

**Charging Current vs. Battery Voltage**  
( $R_{SET} = 1.24k\Omega$ )

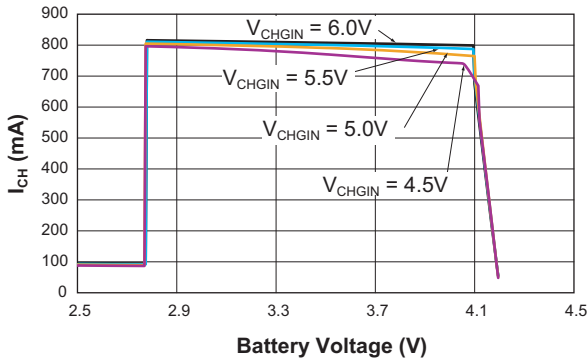

**Preconditioning Threshold Voltage vs. Temperature**

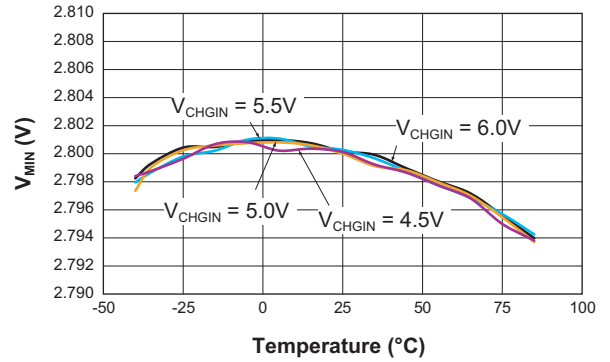

**Preconditioning Charge Current vs. Temperature**  
( $V_{BAT} = 2.5V, R_{SET} = 1.24k\Omega$ )

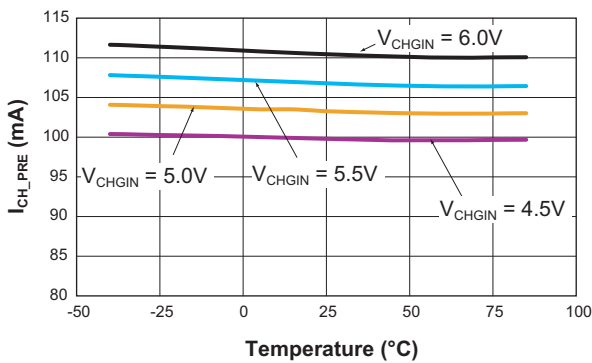

**Recharge Voltage Threshold vs. Temperature**  
( $V_{RCH}$  set to 4.0V by  $I^2C$ )

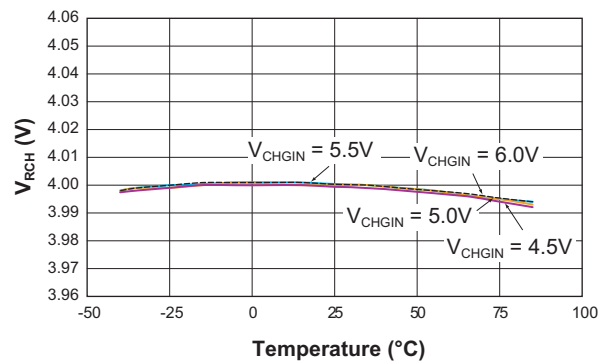

**Output Charge Voltage Regulation vs. Temperature**  
(End of Charge Voltage)

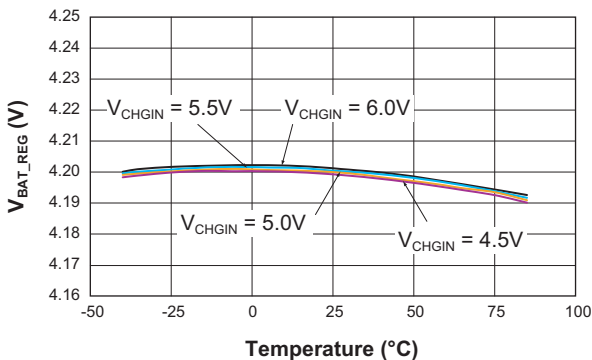

**Charge Termination Threshold Current vs. Temperature**

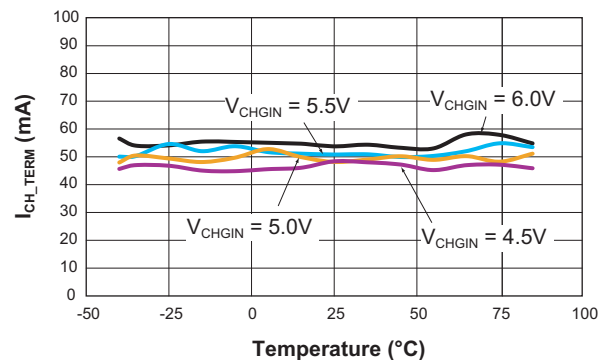

**Typical Characteristics – Charger (continued)**

**Constant Current Mode Charge Current vs. Temperature**  
( $V_{BAT} = 3.6V$ ;  $R_{ISET} = 1.24k\Omega$ )

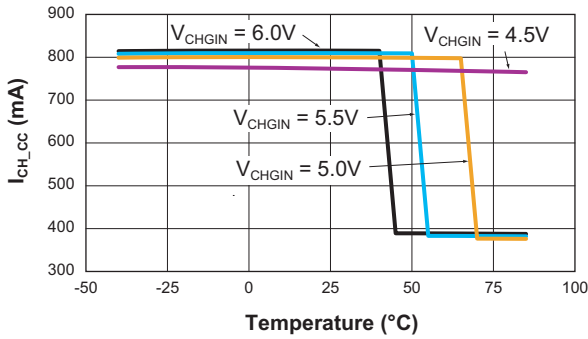

**Constant Current Mode Charge Current vs. Input Voltage**  
( $R_{SET} = 1.24k\Omega$ )

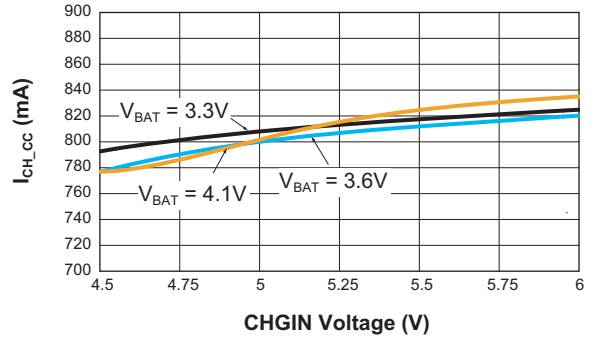

## Total Power Solution for Portable Applications

### Typical Characteristics – Step-Down Buck Converter

**Step-Down Buck Efficiency vs. Output Current**  
( $V_{OUT} = 1.24V$ ;  $L = 2.2\mu H$ )

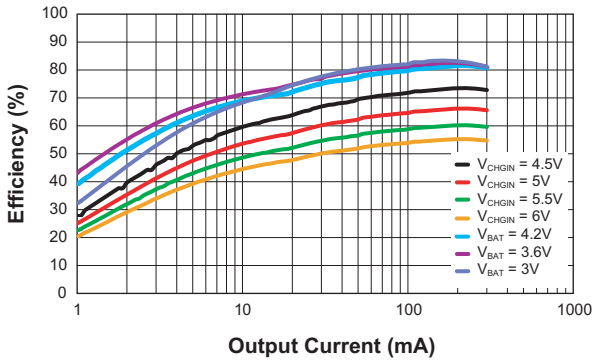

**Step-Down Buck Load Regulation vs. Output Current**  
( $V_{OUT} = 1.24V$ ;  $L = 2.2\mu H$ )

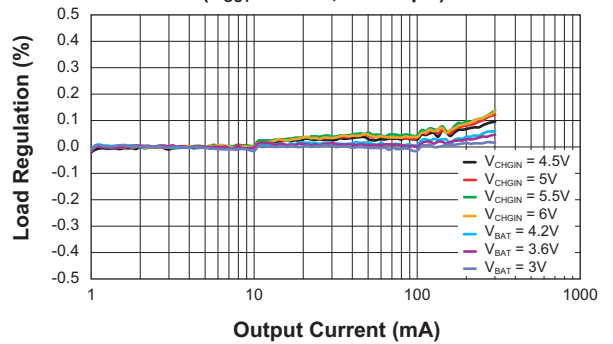

**Step-Down Buck Line Regulation vs. CHGIN and Battery Input Voltage**  
( $V_{OUT} = 1.24V$ ;  $L = 2.2\mu H$ )

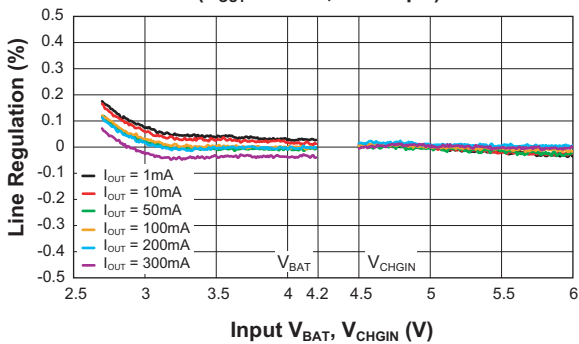

**Step-Down Buck Output Voltage vs. Temperature**  
( $I_{OUT} = 10mA$ )

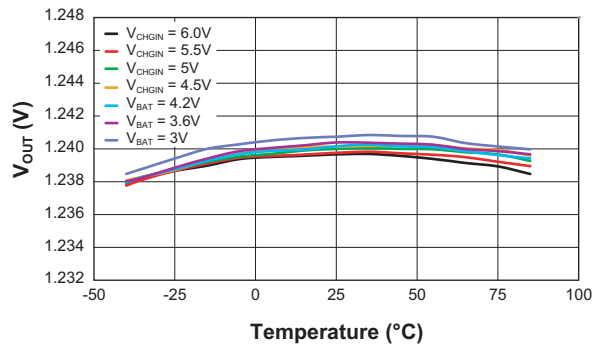

**V\_BAT Line Transient Response Step-Down Buck**  
( $V_{BAT} = 3.5V$  to  $4.2V$ ;  $I_{OUT} = 300mA$ ;  $V_{OUT} = 1.24V$ ;  $C_{OUT} = 4.7\mu F$ )

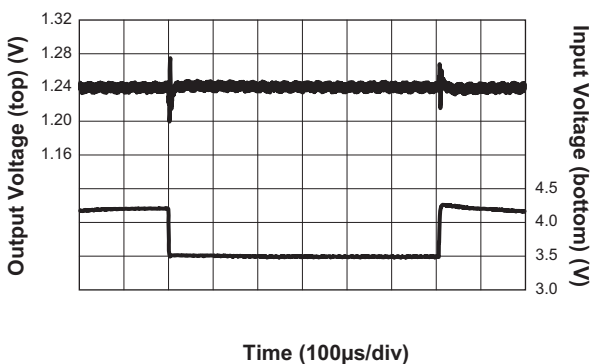

**Load Transient Response Step-Down Buck**  
( $10mA$  to  $150mA$ ;  $V_{BAT} = 3.6V$ ;  $V_{OUT} = 1.24V$ ;  $C_{OUT} = 4.7\mu F$ )

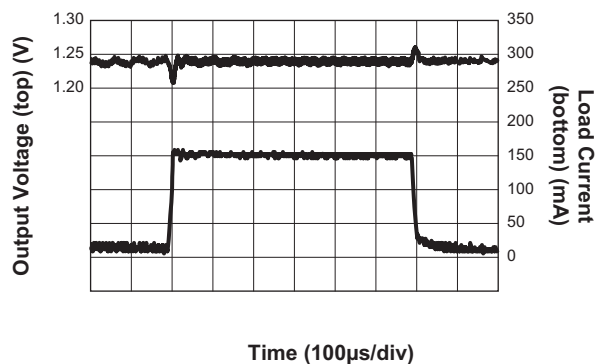

**Typical Characteristics – Step-Down Buck Converter (continued)**

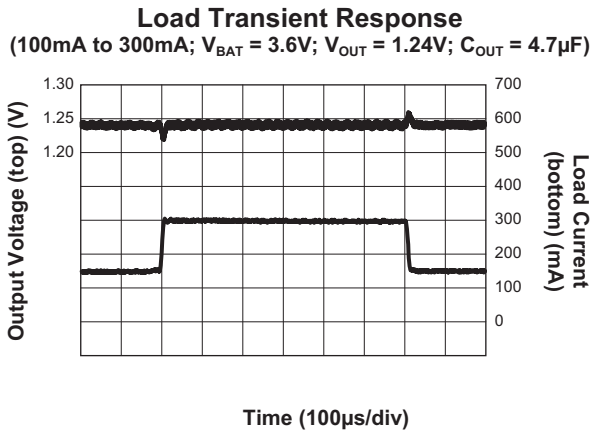

## Typical Characteristics - LDO1

**LDO1 Load Regulation vs. Output Current Using CHGIN Input**  
( $V_{OUT1} = 3.4V$ )

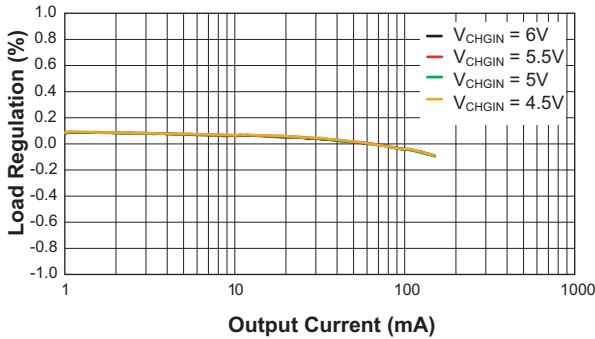

**LDO1 Load Regulation vs. Output Current Using Battery Input**  
( $V_{OUT1} = 3.4V$ )

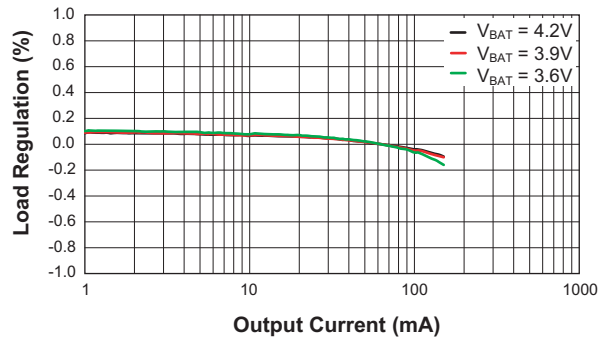

**LDO1 Output Voltage vs. Temperature**  
( $I_{OUT1} = 10mA$ )

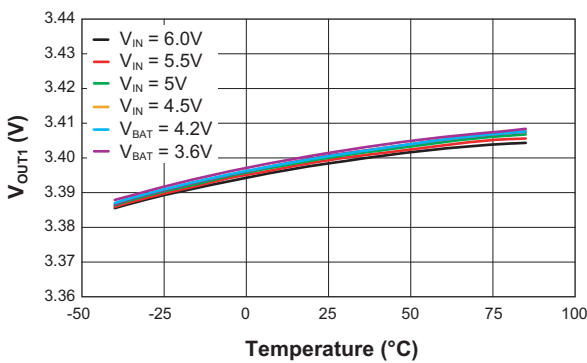

**LDO1 Line Regulation vs. CHGIN and Battery Input Voltage**  
( $V_{OUT1} = 3.4V$ )

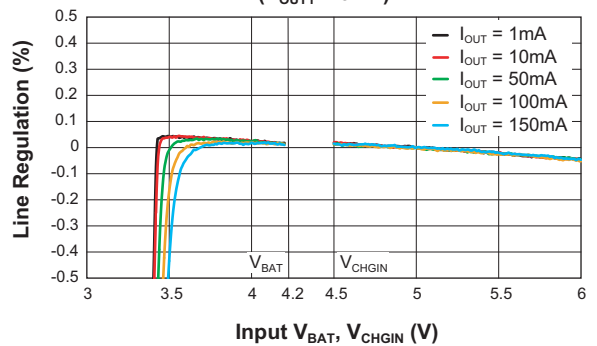

**LDO1 Dropout Characteristics vs. Input Voltage**  
( $V_{OUT1} = 3.4V$ )

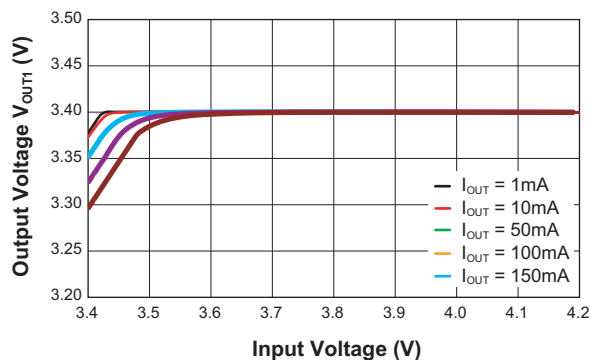

**LDO1 Dropout Voltage vs. Output Current**  
( $V_{OUT1} = 3.4V$ )

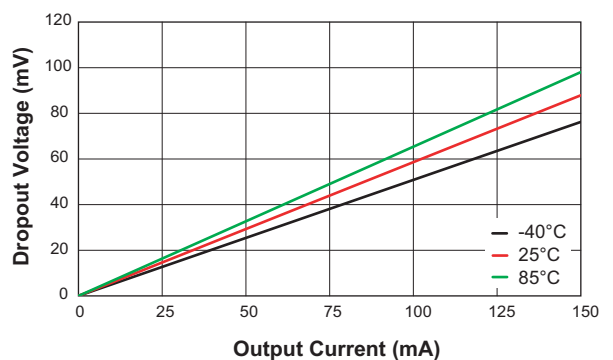

## Typical Characteristics – LDO1 (continued)

**V<sub>BAT</sub> Line Transient Response LDO1**  
(V<sub>BAT</sub> = 3.7V to 4.2V; I<sub>OUT1</sub> = 150mA; V<sub>OUT1</sub> = 3.4V)

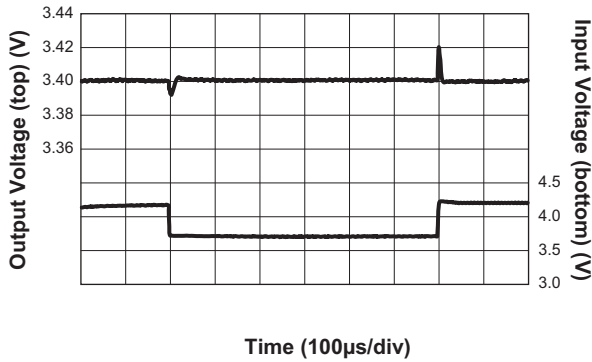

**Load Transient Response LDO1**  
(10mA to 75mA; V<sub>BAT</sub> = 3.6V; V<sub>OUT</sub> = 3.4V)

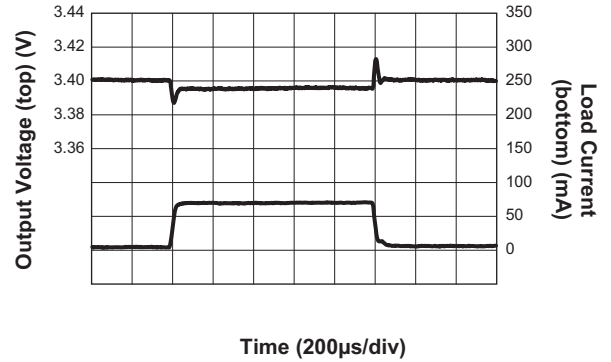

**Load Transient Response LDO1**  
(75mA to 150mA; V<sub>BAT</sub> = 3.6V; V<sub>OUT</sub> = 3.4V)

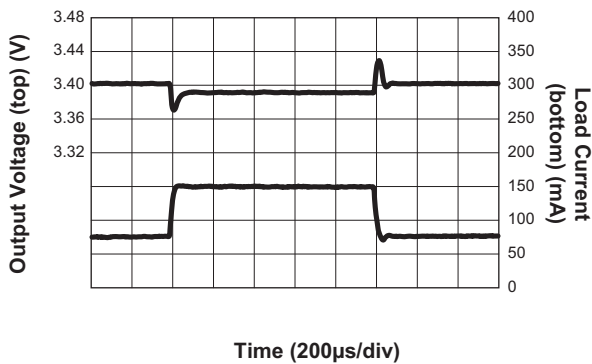

## Typical Characteristics – LDO2

**LDO2 Dropout Characteristics vs. Input Voltage**  
(V<sub>OUT2</sub> = 3.4V)

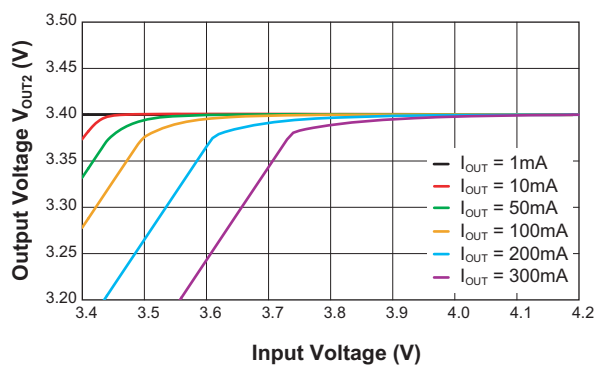

**LDO2 Dropout Voltage vs. Output Current**  
(V<sub>OUT2</sub> = 3.4V)

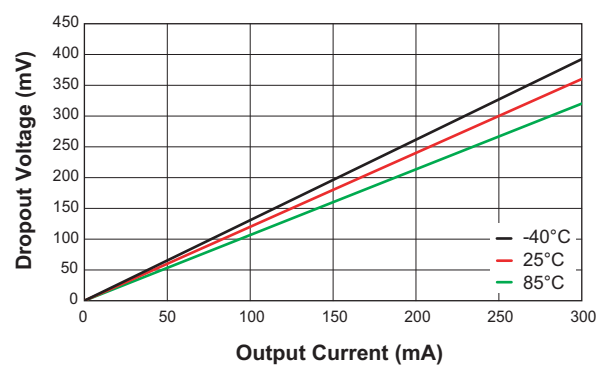

## Typical Characteristics – LDO4

**LDO4 Load Regulation vs. Output Current Using CHGIN Input**  
( $V_{OUT4} = 1.85V$ )

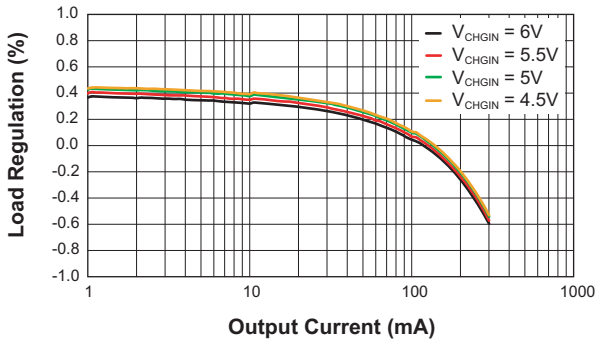

**LDO4 Load Regulation vs. Output Current Using Battery Input**  
( $V_{OUT4} = 1.85V$ )

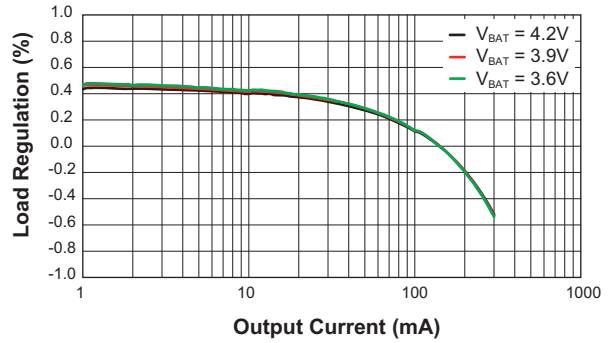

**LDO4 Output Voltage vs. Temperature**  
( $I_{OUT4} = 10mA$ )

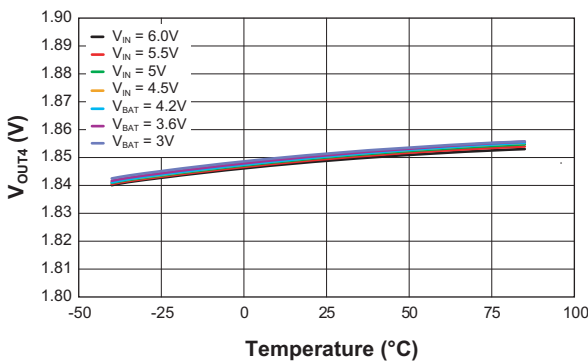

**LDO4 Line Regulation vs. CHGIN and Battery Input Voltage**  
( $V_{OUT4} = 3.4V$ )

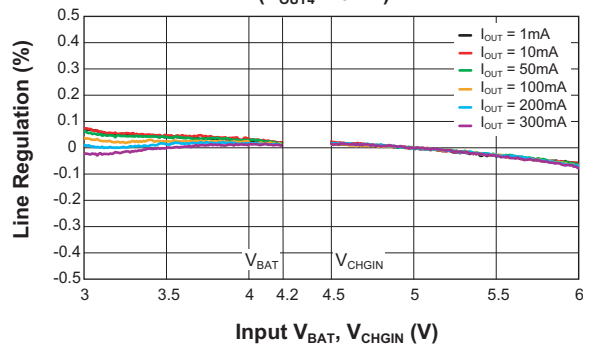



**Typical Characteristics – General**

**Quiescent Current vs. Input Voltage**  
(LDO1 + LDO3 + LDO5; No Load)

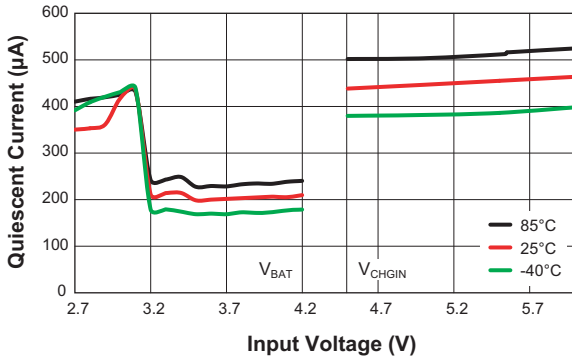

**Start-up Sequence**  
Permanent-Enabled (PE) Supplies  
(V<sub>CHGIN</sub> = 5.0V)

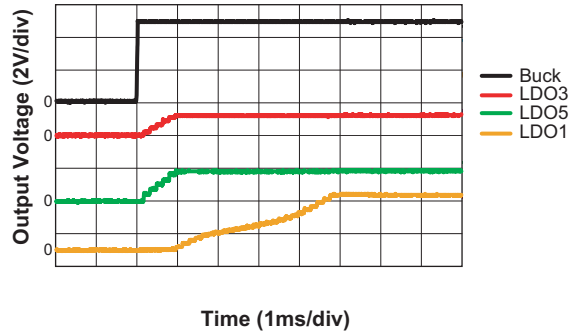

**Start-up Sequence**  
Non-Permanent (NP) Supplies  
(V<sub>CHGIN</sub> = 5.0V)

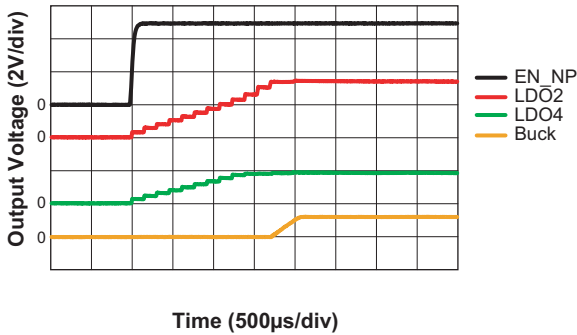

**Watchdog Timer**  
(WDI = 0V)

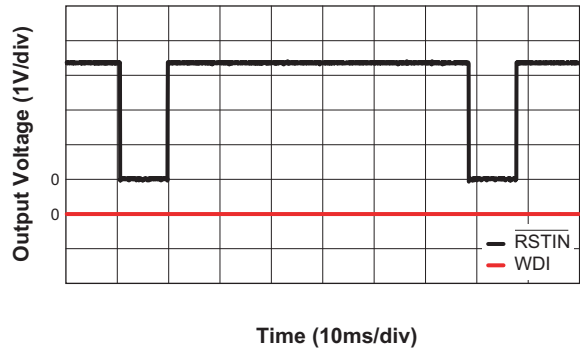

**LDO Power Supply Rejection Ratio, PSRR**  
(I<sub>OUT3</sub> = 10mA, BW = 100~100KHz)

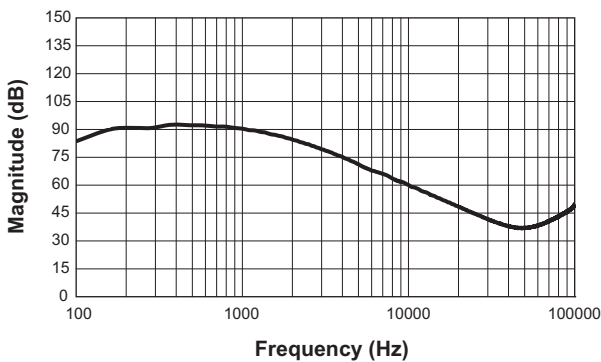

**LDO Output Voltage Noise**  
(No Load; Power BW: 100~100KHz)

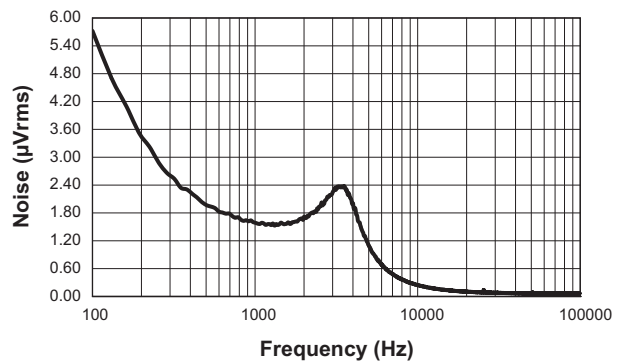

**Typical Characteristics – General (continued)**

**LDO Output Voltage Noise**  
( $I_{OUT3} = 10\text{mA}$ , Power BW = 100~100KHz)

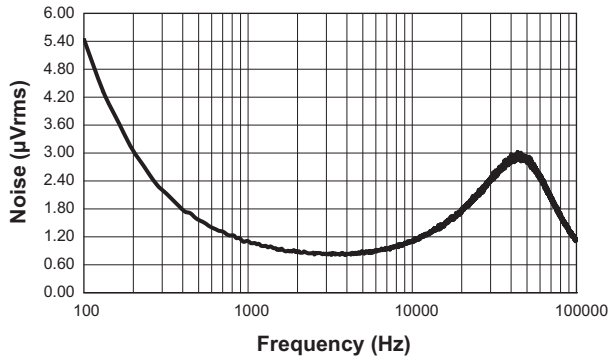

**Functional Block Diagram**

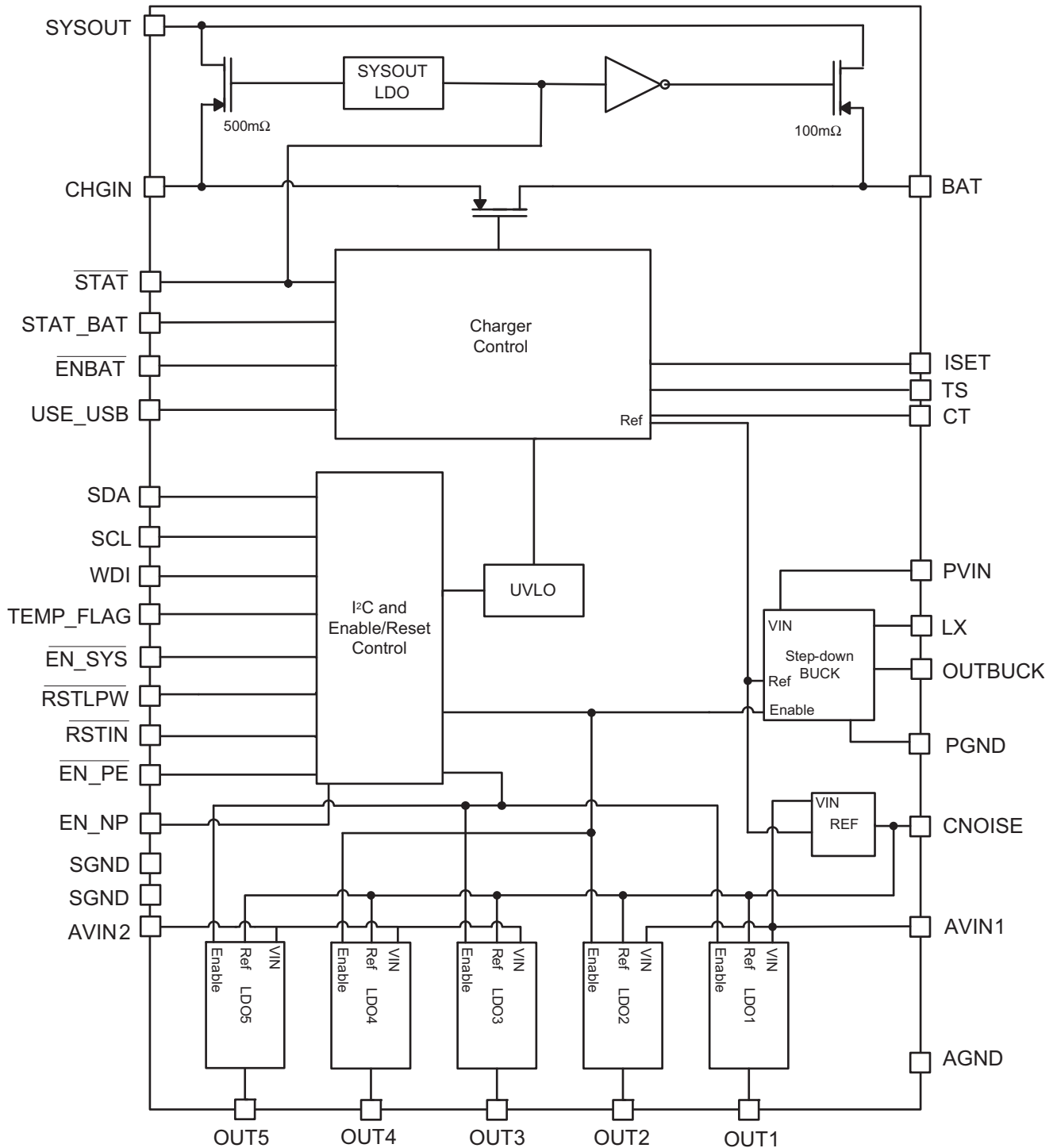

**Total Power Solution for Portable Applications**

## Functional Description

The AAT3601 is a complete power management solution. It seamlessly integrates an intelligent, stand-alone CC/CV (Constant-Current/Constant-Voltage), linear-mode single-cell battery charger with one step-down Buck converter and five low-dropout (LDO) regulators to provide power from either a wall adapter or a single-cell Lithium-Ion/Polymer battery. Internal load switches allow the LDO regulators and DC-DC converter to operate from the best available power source of either an AC wall adapter, USB port supply, or battery.

If only the battery is available, then the voltage regulators and converter are powered directly from the battery through a 100mΩ load switch. (The charger is put into sleep mode and draws less than 1μA quiescent current.) If the system is connected to a wall adapter, then the voltage converters are powered directly from the adapter through a 500mΩ load switch and the battery is disconnected from the voltage converter inputs. This allows the system to operate regardless of the charging state of the battery or with no battery. The LDOs and DC/DC converter are separated into Permanently-Enabled (PE) system-on supplies and Non-Permanent (NP) separate enable supplies referring to the two independent enable functions.

## System Output (SYSOUT)

Intelligent control of the integrated load switches is managed by the switch control circuitry to allow the step-down converter and the LDOs to have the best available power source. When the CHGIN pin voltage is above 4.5V, the system automatically turns on and the power to the SYSOUT pin will be provided by either the CHGIN pin or the BAT pin. When the USE\_USB pin is low, the CHGIN provides power to SYSOUT through an internal LDO regulated to 3.9V. When the USE\_USB pin is high or if forced through use of an I<sup>2</sup>C command, the BAT pin is shorted to SYSOUT through a 100mΩ switch. If a CHGIN voltage is not present and the system is enabled, SYSOUT will be shorted to BAT.

This system allows the step-down converter and LDOs to always have the best available source of power. This also allows the voltage converters to operate with no battery, or with a battery voltage that falls below the precondition trickle charge threshold.

## Typical Power Up Sequence

The AAT3601 supports two enable/disable schemes. System startup is initiated whenever one of the following conditions occurs:

1. A push-button is used to assert  $\overline{\text{EN\_SYS}}$  low when a valid supply (>CHGIN UVLO) is not connected to the charger input CHGIN.
2. A valid adaptor supply (>CHGIN UVLO) is connected to the charger input CHGIN.

### Case 1

The startup sequence for the AAT3601 is typically initiated by pulling the  $\overline{\text{EN\_SYS}}$  pin low with a pushbutton switch (see Figure 1). The SYSOUT is the first block to be turned on. When the output of the SYSOUT reaches 90% of its final value, then the PE supplies LDO1, LDO3 and LDO5 are enabled if  $\overline{\text{EN\_PE}}$  is low. When the PE supplies reach 90% of their final value, the 800ms  $\overline{\text{RSTLPW}}$  timer is initiated holding the microprocessor in reset. When the  $\overline{\text{RSTLPW}}$  pin goes High, the NP sequence supplies LDO2, LDO4 and OUTBUCK can be enabled and disabled as desired using the EN\_NP pin. When the NP supplies reach 90% of their final value, the 10ms  $\overline{\text{RSTIN}}$  timer is released. The NP outputs should not be started up until after the  $\overline{\text{RSTLPW}}$  pin goes high. Do not start all the outputs up at the same time. The state of  $\overline{\text{EN\_SYS}}$  is latched as long as either CHGIN or BAT is connected to the device.

### Case 2

Alternatively, the startup sequence is automatically started without the pushbutton switch when the CHGIN pin rises above its UVLO threshold. The battery charger is started when CHGIN\_OK is internally enabled. The  $\overline{\text{STAT}}$  pin goes high and the system is enabled.

Sequence of startup depends on whether or not the adapter input is connected or open. The timing diagrams in Figures 2 and 3 illustrate the two cases. A typical startup and shutdown process proceeds as follows (referring to Figures 1, 2 and 3).

## Typical Power Down Sequence

If only the battery is connected and the voltage level is above the BAT UVLO, then the  $\overline{\text{EN\_PE}}$  pin can be held low in order to power down AAT3601. When the voltage at the CHGIN pin is above the CHGIN UVLO, the device cannot be powered down but the  $\overline{\text{EN\_PE}}$  and EN\_NP pins can be used to disable the PE and NP supplies. If the adapter supply at the CHGIN pin is disconnected, the device will power down even if BAT is connected if the  $\overline{\text{EN\_SYS}}$  state was not first latched into the device by pulling it low when either BAT or CHGIN is connected. If CHGIN falls below UVLO without being disconnected, the  $\overline{\text{EN\_SYS}}$  will still be latched and the device will remain powered. The outputs of the LDOs are internally pulled to ground with 10k during shutdown to discharge the output capacitors and ensure a fast turn-off response time.

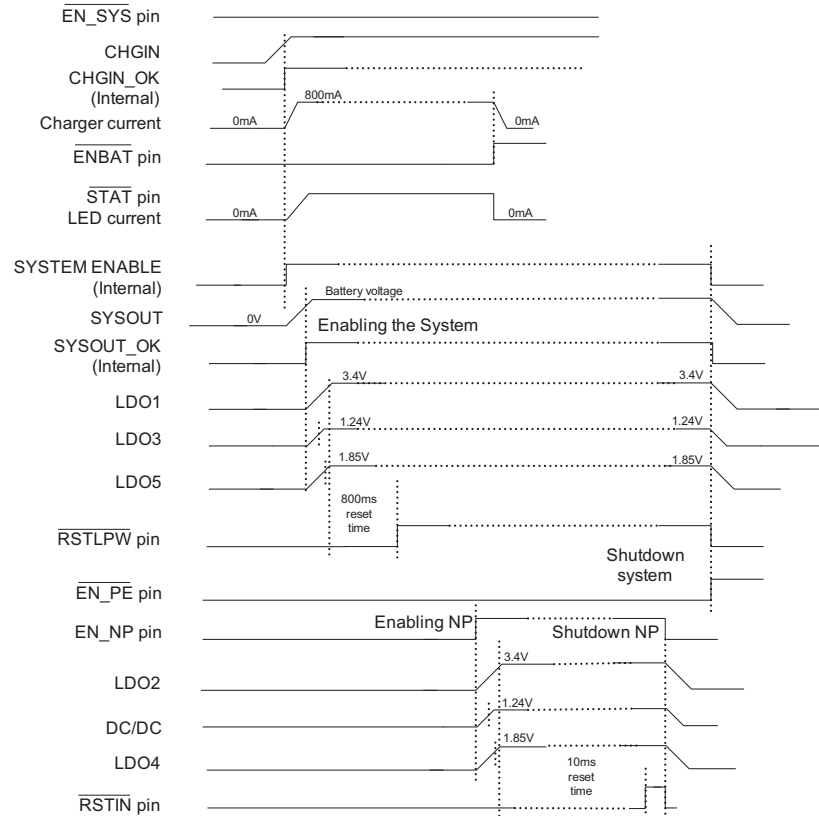

**Total Power Solution for Portable Applications**

**Figure 2b: Power Up/Down Sequence; Case 2, Connecting the Adapter Automatically Starts the System.**

### Watchdog Timer Input (WDI)

The AAT3601 includes an internal watchdog timer that can be controlled by a  $\mu$ P. After  $\overline{RSTIN}$  goes high, the watchdog timer must get clock edges on the WDI pin from the processor. The WDI clock edges must be  $< 60\text{ms}$  apart to reset the internal watchdog timer or the  $\overline{RSTIN}$  pin will become active low.

### Battery Charger

Figure 4 illustrates the entire battery charging profile which consists of three phases.

1. Preconditioning-Current Mode (Trickle) Charge
2. Constant-Current Mode Charge
3. Constant-Voltage Mode Charge

### Preconditioning Trickle Charge

Battery charging commences only after the AAT3601 battery charger checks several conditions in order to maintain a safe charging environment. The System Operation

Flow Chart for the Battery Charger operation is shown in Figure 5. The input supply must be above the minimum operating voltage ( $UVLO$ ) and the enable pin ( $\overline{ENBAT}$ ) must be low (it is internally pulled down). When the battery is connected to the BAT pin, the battery charger checks the condition of the battery and determines which charging mode to apply.

### Preconditioning-Current Mode Charge Current

If the battery voltage is below the Preconditioning Voltage Threshold  $V_{MIN}$ , then the battery charger initiates precondition trickle charge mode and charges the battery at 12% of the programmed constant-current magnitude. For example, if the programmed current is 500mA, then the trickle charge current will be 60mA. Trickle charge is a safety precaution for a deeply discharged cell. It also reduces the power dissipation in the internal series pass MOSFET when the input-output voltage differential is at its highest.

**Total Power Solution for Portable Applications**

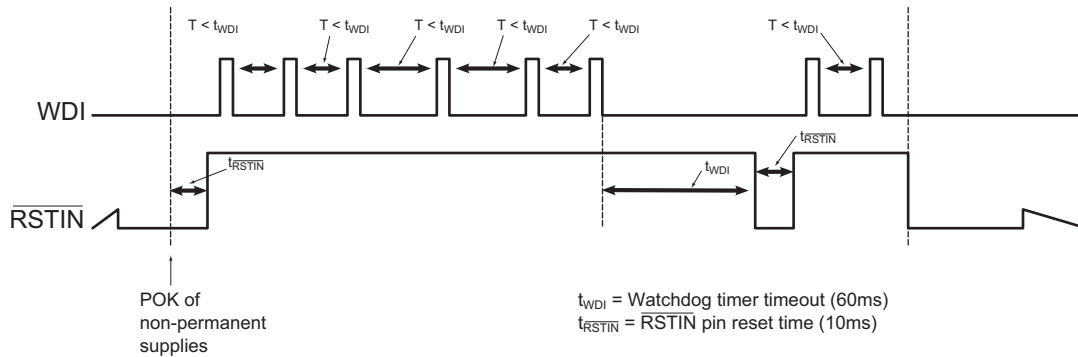

**Figure 3: Watchdog Timer Timing Diagram.**

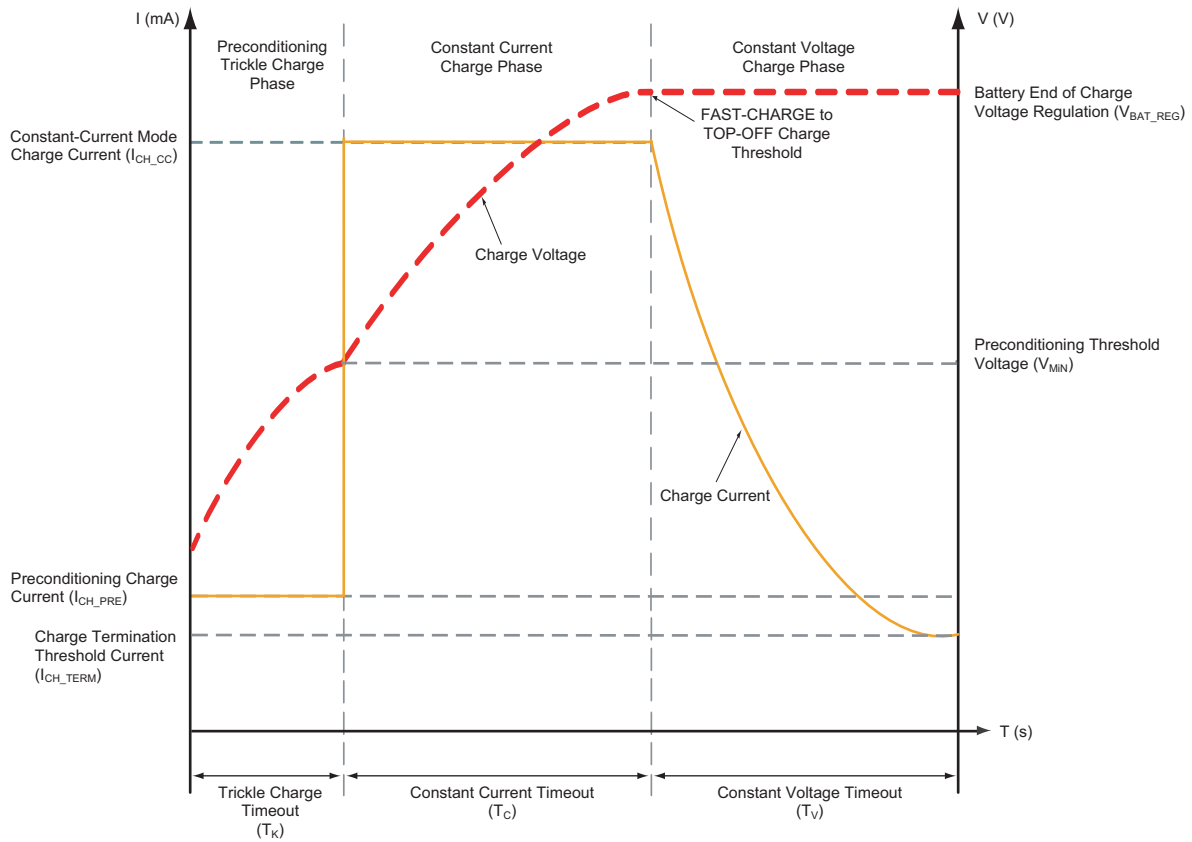

**Figure 4: Current vs. Voltage and Charger Time Profile.**

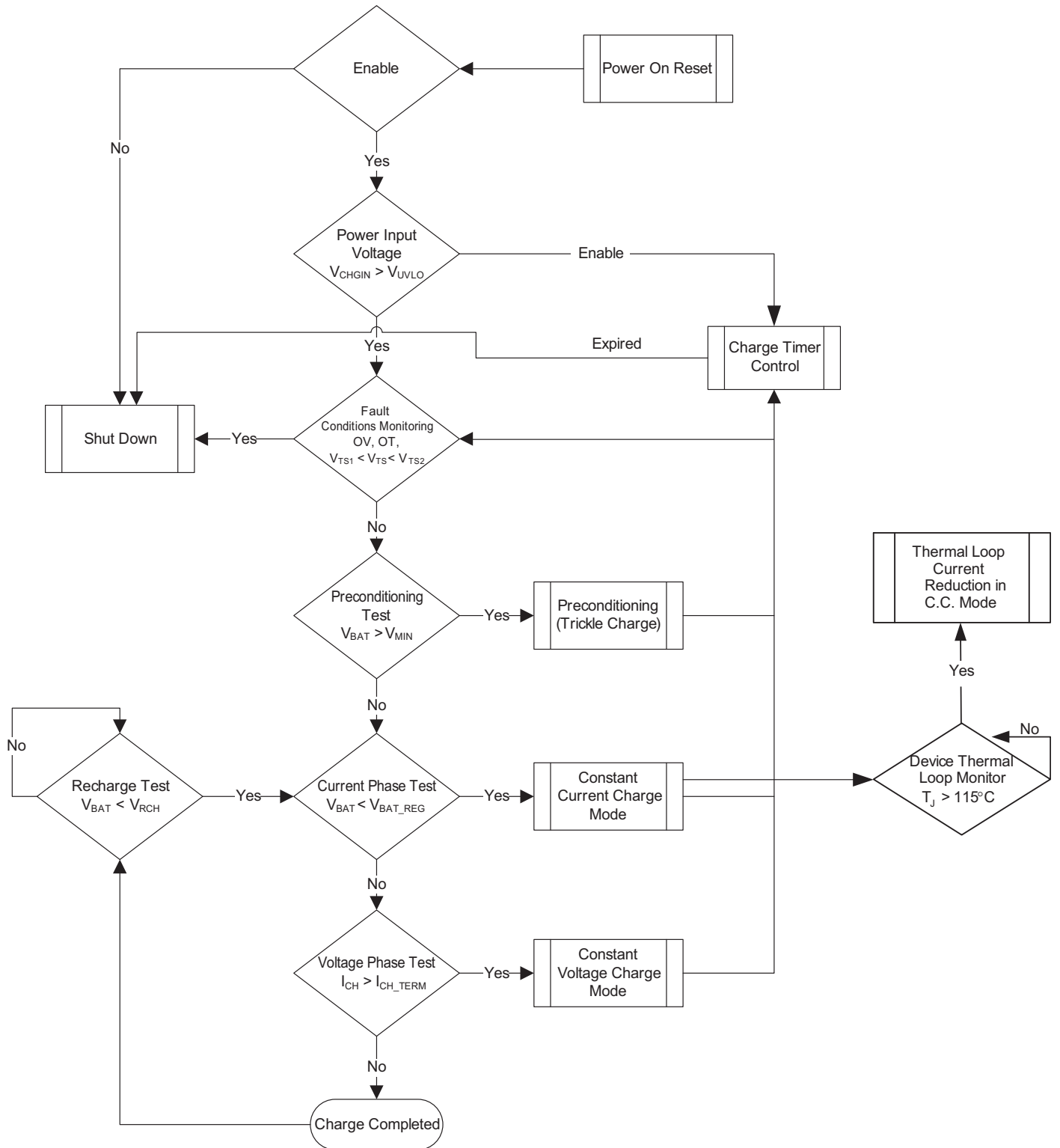

**Figure 5: System Operation Flow Chart for the Battery Charger.**



**Total Power Solution for Portable Applications**
**Constant-Current Mode Charge Current**

Trickle charge continues until the battery voltage reaches  $V_{MIN}$ . At this point the battery charger begins constant-current charging. The current level default for this mode is programmed using a resistor from the ISET pin to ground. Once that resistor has been selected for the default charge current, then the current can be adjusted through I<sup>2</sup>C from a range of 40% to 180% of the programmed default charge current. Programmed current can be set at a minimum of 100mA and up to a maximum of 1.44A. When the CHGIN\_OK signal goes low, the default I<sup>2</sup>C setting of 100% is reset. If the USE\_USB signal is high when this happens, the charge current is reset to an internally set 100mA current until the microcontroller sends another I<sup>2</sup>C signal to change the charge current. (see I<sup>2</sup>C Programming section).

**Constant-Voltage Mode Charge**

Constant current charging will continue until the battery voltage reaches the Output Charge Voltage Regulation point  $V_{BAT\_REG}$ . When the battery voltage reaches the regulation voltage ( $V_{BAT\_REG}$ ), the battery charger will transition to constant-voltage mode.  $V_{BAT\_REG}$  is factory programmed to 4.2V (nominal). Charging in constant-voltage mode will continue until the charge current has reduced to the end of charge termination current programmed using the I<sup>2</sup>C interface (5%, 10%, 15%, or 20%).

**Power Saving Mode**

After the charge cycle is complete, the battery charger turns off the series pass device and automatically goes into a power saving sleep mode. During this time, the series pass device will block current in both directions to prevent the battery from discharging through the battery charger.

The battery charger will remain in sleep mode even if the charger source is disconnected. It will come out of sleep mode if either the battery terminal voltage drops below the  $V_{RCH}$  threshold, the charger ENBAT pin is recycled, or the charging source is reconnected. In all cases, the battery charger will monitor all parameters and resume charging in the most appropriate mode.

**Temperature Sense (TS)**

The TS pin is available to monitor the battery temperature. Connect a 10k NTC resistor from the TS pin to ground. The TS pin outputs a 75 $\mu$ A constant current into the resistor and monitors the voltage to ensure that the battery temperature does not fall outside the limits depending on the Temperature coefficient of the resistor used. When the voltage goes above 2.39V or goes below 331mV, the charging current will be suspended.

**Charge Safety Timer (CT)**

While monitoring the charge cycle, the AAT3601 utilizes a charge safety timer to help identify damaged cells and to ensure that the cell is charged safely. Operation is as follows: upon initiating a charging cycle, the AAT3601 charges the cell at 10% of the programmed maximum charge until  $V_{BAT} > 2.8V$ . If the cell voltage fails to the precondition threshold of 2.8V (typ) before the safety timer expires, the cell is assumed to be damaged and the charge cycle terminates. If the cell voltage exceeds 2.8V prior to the expiration of the timer, the charge cycle proceeds into fast charge. Three timeout periods of 1 hour for Trickle Charge mode, 3 hours for Constant Current Mode and 3 hours for Constant Voltage mode.

Mode	Time
Trickle Charge ( $T_k$ ) Time Out	25 minutes
Trickle Charge ( $T_k$ ) + Constant Current ( $T_c$ ) Mode Time Out	3 hours
Constant Voltage ( $T_v$ ) Mode Time Out	3 hours

**Table 1: Charge Safety Timer (CT) Timeout Period for a 0.1 $\mu$ F Ceramic Timing Capacitor.**

The CT pin is driven by a constant current source and will provide a linear response to increases in the timing capacitor value. Thus, if the timing capacitor were to be doubled from the nominal 0.1 $\mu$ F value, the time-out periods would be doubled. If the programmable watchdog timer function is not needed, it can be disabled by terminating the CT pin to ground or disabled using the I<sup>2</sup>C bus. The CT pin should not be left floating or unterminated, as this will cause errors in the internal timing control circuit. The constant current provided to charge

**Total Power Solution for Portable Applications**

the timing capacitor is very small, and this pin is susceptible to noise and changes in capacitance value. Therefore, the timing capacitor should be physically located on the printed circuit board layout as close as possible to the CT pin. Since the accuracy of the internal timer is dominated by the capacitance value, a 10% tolerance or better ceramic capacitor is recommended. Ceramic capacitor materials, such as X7R and X5R types, are a good choice for this application.

### Programming Charge Current (ISET)

The default constant current mode charge level is user programmed with a set resistor placed between the ISET pin and ground. The accuracy of the constant charge current, as well as the preconditioning trickle charge current, is dominated by the tolerance of the set resistor. For this reason, a 1% tolerance metal film resistor is recommended for the set resistor function. The constant charge current levels from 100mA to 1A may be set by selecting the appropriate resistor value from Table 2 and Figures 6 and 7. The ISET pin current to charging current ratio is 1 to 800. It is regulated to 1.25V during constant current mode unless changed using I<sup>2</sup>C commands. It can be used as a charging current monitor, based on the equation:

$$I_{CH} = 800 \cdot \left( \frac{V_{ISET}}{R_{ISET}} \right)$$

During preconditioning charge, the ISET pin is regulated to 0.2V (Figure 6), but the equation stays the same. During constant voltage charge mode, the ISET pin voltage will slew down and be directly proportional to the battery current at all times.

Constant Charging Current $I_{CH\_CC}$ (mA)	Set Resistor Value (k $\Omega$ )
100	10
200	4.99
300	3.32
400	2.49
500	2
600	1.65
700	1.43
800	1.24
900	1.1
1000	1

**Table 2: Constant Current Charge vs. I<sub>SET</sub> Resistor Value.**

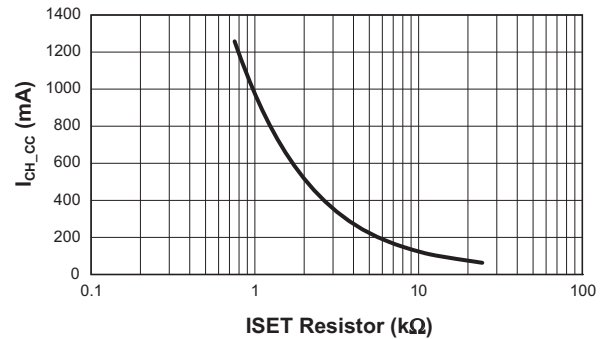

**Figure 6: Constant-Current Mode Charge  $I_{CH\_CC}$  Setting vs.  $I_{SET}$  Resistor.**

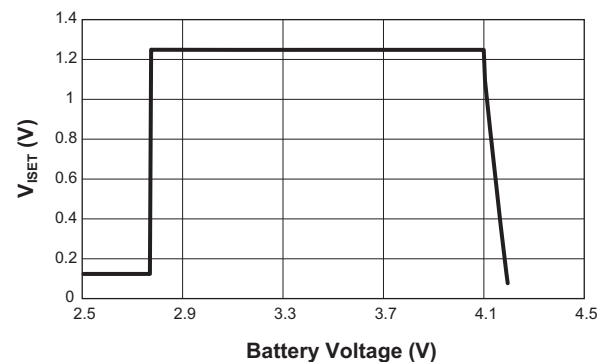

**Figure 7:  $I_{SET}$  Voltage vs. Battery Voltage.**

### Reverse Battery Leakage

The AAT3601 includes internal circuitry that eliminates the need for series blocking diodes, reducing solution size and cost as well as dropout voltage relative to conventional battery chargers. When the input supply is removed or when CHGIN goes below the AAT3601's under-voltage lockout (UVLO) voltage, or when CHGIN drops below  $V_{BAT}$ , the AAT3601 automatically reconfigures its power switches to minimize current drain from the battery.

### Charge Status Output (STAT and STAT\_BAT)

The AAT3601 provides battery charging status via a status pin. The  $\overline{STAT}$  is active low open drain for driving and LED.  $\overline{STAT\_BAT}$  is the same function as  $\overline{STAT}$  pin but with opposite polarity to be used as a  $\mu P$  flag. The status pin can indicate the following conditions:

**Total Power Solution for Portable Applications**

Event Description	STAT
No battery charging activity.	Low (to GND)
Battery charging	High (to $V_{OUT1}$ )
Charging completed	Low (to GND)

**Table 3: Charge Status Output (STAT).**
**CHGIN Bypass Capacitor Selection**

CHGIN is the power input for the AAT3601 battery charger. The battery charger is automatically enabled whenever a valid voltage is present on CHGIN. In most applications, CHGIN is connected to either a wall adapter or USB port. Under normal operation, the input of the charger will often be "hot-plugged" directly to a powered USB or wall adapter cable, and supply voltage ringing and overshoot may appear at the CHGIN pin. A high quality capacitor connected from CHGIN to G, placed as close as possible to the IC, is sufficient to absorb the energy. Wall-adapter powered applications provide flexibility in input capacitor selection, but the USB specification presents limitations to input capacitance selection. In order to meet both the USB 2.0 and USB OTG (On The Go) specifications while avoiding USB supply under-voltage conditions resulting from the current limit slew rate ( $100\text{mA}/\mu\text{s}$ ) limitations of the USB bus, the CHGIN bypass capacitance value must be between  $1\mu\text{F}$  and  $4.7\mu\text{F}$ . Ceramic capacitors are often preferred for bypassing applications due to their small size and good surge current ratings, but care must be taken in applications that can encounter

hot plug conditions as their very low ESR, in combination with the inductance of the cable, can create a high-Q filter that induces excessive ringing at the CHGIN pin. This ringing can couple to the output and be mistaken as loop instability, or the ringing may be large enough to damage the input itself. Although the CHGIN pin is designed for maximum robustness and an absolute maximum voltage rating of  $+6.5\text{V}$  for transients, attention must be given to bypass techniques to ensure safe operation. As a result, design of the CHGIN bypass must take care to "de-Q" the filter. This can be accomplished by connecting a  $1\Omega$  resistor in series with a ceramic capacitor (as shown in Figure 8A), or by bypassing with a tantalum or electrolytic capacitor to utilize its higher ESR to dampen the ringing, as shown in Figure 8B. For additional protection, Zener diodes with 6V clamp voltages may also be used. In any case, it is always critical to evaluate voltage transients at the CHGIN pin with an oscilloscope to ensure safe operation.

**Thermal Considerations**

The actual maximum charging current is a function of Charge Adapter input voltage, the state of charge of the battery at the moment of charge, the system supply current from SYSOUT, and the ambient temperature and the thermal impedance of the package. The maximum programmable current may not be achievable under all operating parameters. Issues to consider are the amount of current being sourced to the SYSOUT pin from the CHGIN LDO at the same time as the charge current to BAT.

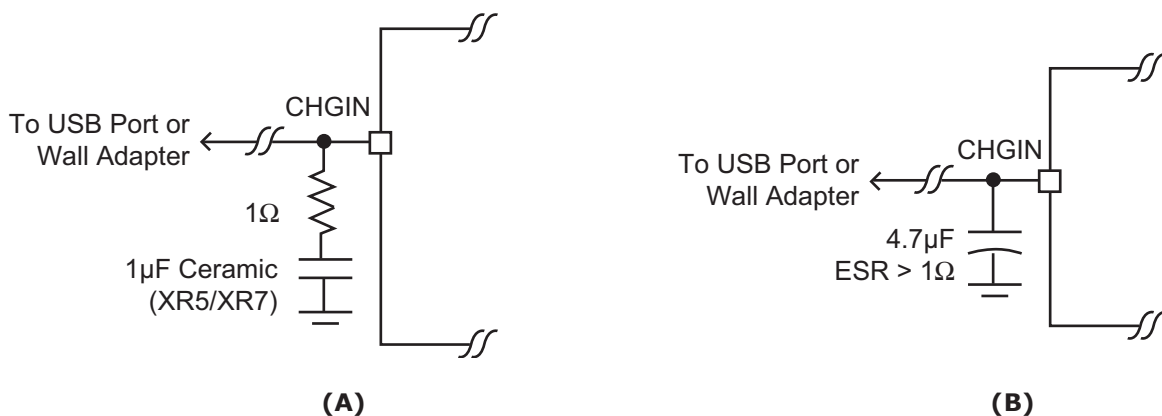
**Figure 8: Hot Plug Requirements.**

## Total Power Solution for Portable Applications

The AAT3601 is offered in a TQFN55-36 package which can provide up to 4W of power dissipation when it is properly bonded to a printed circuit board and has a maximum thermal resistance of 25°C/W. Many considerations should be taken into account when designing the printed circuit board layout, as well as the placement of the charger IC package in proximity to other heat generating devices in a given application design. The ambient temperature around the charger IC will also have an effect on the thermal limits of a battery charging application. The maximum limits that can be expected for a given ambient condition can be estimated by the following discussion. First, the maximum power dissipation for a given situation should be calculated:

$$P_{D(MAX)} = \frac{(T_{J(MAX)} - T_A)}{\theta_{JA}}$$

Where:

$P_{D(MAX)}$  = Maximum Power Dissipation (4W)

$\theta_{JA}$  = Package Thermal Resistance (25°C/W)

$T_{J(MAX)}$  = Maximum Device Junction Temperature (°C)  
(140°C)

$T_A$  = Ambient Temperature (°C)

Next, the power dissipation for the charger can be calculated by the following equation:

$$P_D = (V_{CHGIN} - V_{BAT}) \cdot I_{CH\_CC} + (V_{CHGIN} \cdot I_{OP}) + (V_{CHGIN} - V_{SYSOUT}) \cdot I_{SYSOUT} \\ + (V_{SYSOUT} - V_{OUT1}) \cdot I_{OUT1} + (V_{SYSOUT} - V_{OUT2}) \cdot I_{OUT2} \\ + (V_{SYSOUT} - V_{OUT3}) \cdot I_{OUT3} + (V_{SYSOUT} - V_{OUT4}) \cdot I_{OUT4} \\ + (V_{SYSOUT} - V_{OUT5}) \cdot I_{OUT5} \\ + I_{OUTBUCK}^2 \cdot \left( R_{DS(ON)L} \cdot \frac{V_{OUTBUCK}}{V_{SYSOUT}} + \frac{R_{DS(ON)H} \cdot [V_{SYSOUT} - V_{OUTBUCK}]}{V_{SYSOUT}} \right)$$

Where:

$P_D$  = Total Power Dissipation by the Device

$V_{CHGIN}$  = CHGIN Input Voltage

$V_{BAT}$  = Battery Voltage at the BAT Pin

$I_{CH\_CC}$  = Constant Charge Current Programmed for the Application

$I_{OP}$  = Quiescent Current Consumed by the IC for Normal Operation (0.5mA)

$V_{SYSOUT}$  and  $I_{SYSOUT}$  = Output Voltage and Load Current from the SYSOUT Pin for the System LDOs and Step-down Converter (3.9V out for SYSOUT)

$R_{DS(ON)H}$  and  $R_{DS(ON)L}$  = On-Resistance of Step-down High and Low Side MOSFETs (0.8Ω each)

$V_{OUTX}$  and  $I_{OUTX}$  = Output Voltage and Load Currents for the LDOs and Step-Down Converter (Default Output Voltages)

By substitution, we can derive the maximum charge current ( $I_{CH\_CC(MAX)}$ ) before reaching the thermal limit condition ( $T_{REG} = 100^\circ\text{C}$ , Thermal Loop Regulation). The maximum charge current is the key factor when designing battery charger applications.

$$I_{CH\_CC(MAX)} = \frac{\frac{(T_{REG} - T_A)}{\theta_{JA}} - (V_{CHGIN} \cdot I_{OP}) - (V_{CHGIN} - V_{SYSOUT}) \cdot I_{SYSOUT}}{[(V_{SYSOUT} - V_{OUT1}) \cdot I_{OUT1}] - (V_{SYSOUT} - V_{OUT2}) \cdot I_{OUT2} \\ - [(V_{SYSOUT} - V_{OUT3}) \cdot I_{OUT3}] - (V_{SYSOUT} - V_{OUT4}) \cdot I_{OUT4} \\ - (V_{SYSOUT} - V_{OUT5}) \cdot I_{OUT5} \\ - I_{OUTBUCK}^2 \cdot \left( R_{DS(ON)L} \cdot \frac{V_{OUTBUCK}}{V_{SYSOUT}} + \frac{R_{DS(ON)H} \cdot (V_{SYSOUT} - V_{OUTBUCK})}{V_{SYSOUT}} \right)}}{V_{IN} - V_{BAT}}$$

In general, the worst condition is when there is the greatest voltage drop across the charger, when battery voltage is charged up to just past the preconditioning voltage threshold and the LDOs and step-down converter are sourcing full output current.

For example, if 700mA and 147mA are being sourced from the 3.9V SYSOUT pin to the LDOs and Buck supply channels respectively (300mA to LDO2, 100mA to LDO1 and 3-5, and 147mA to Buck; see buck efficiency graph for 300mA output current) with a CHGIN supply of 5V, and the battery is being charged at 3.0V, then the power dissipated will be 3.49W. A reduction in the charge current (through I<sup>2</sup>C) may be necessary in addition to reduction provided by the internal thermal loop of the charger itself.

For the above example at  $T_A = 30^\circ\text{C}$ , the  $I_{CH\_CC(MAX)} = 459\text{mA}$ .

### Thermal Overload Protection

The AAT3601 integrates thermal overload protection circuitry to prevent damage resulting from excessive thermal stress that may be encountered under fault conditions, for example. This circuitry disables all regulators if the AAT3601 die temperature exceeds 140°C, and prevents the regulators from being enable until the die temperature drops by 15°C (typ).

## Total Power Solution for Portable Applications

### Synchronous Step-Down (Buck) Converter

The AAT3601 contains a high performance 300mA, 1.5MHz synchronous step-down converter. The step-down converter operates to ensure high efficiency performance over all load conditions. It requires only 3 external power components ( $C_{IN}$ ,  $C_{OUT}$ , and L). A high DC gain error amplifier with internal compensation controls the output. It provides excellent transient response and load/line regulation. Transient response time is typically less than 20 $\mu$ s. The converter has soft start control to limit inrush current and transitions to 100% duty cycle at drop out.

The step-down converter input pin PVIN should be connected to the SYSOUT LDO output pin. The output voltage is internally fixed at 1.24V. Power devices are sized for 300mA current capability while maintaining over 90% efficiency at full load.

### Input/Output Capacitor and Inductor

Apart from the input capacitor that is shared with the LDO inputs, only a small L-C filter is required at the output side for the step-down converter to operate properly. Typically, a 2.2 $\mu$ H inductor such as the Sumida CDRH2D11NP-2R2NC and a 4.7 $\mu$ F ceramic output capacitor are recommended for low output voltage ripple and small component size. Ceramic capacitors with X5R or X7R dielectrics are highly recommended because of their low ESR and small temperature coefficients. A 10 $\mu$ F ceramic input capacitor is sufficient for most applications.

### Control Loop

The converter is a peak current mode step-down converter. The inner, wide bandwidth loop controls the inductor peak current. The inductor current is sensed through the P-channel MOSFET (high side) which is also used for short circuit and overload protection. A fixed slope compensation signal is added to the sensed current to maintain stability for duty cycles greater than 50%. The peak current mode loop appears as a voltage programmed current source in parallel with the output capacitor.

The output of the voltage error amplifier programs the current mode loop for the necessary peak inductor current to force a constant output voltage for all load and

line conditions. The voltage feedback resistive divider is internal and the error amplifier reference voltage is 0.45V. The voltage loop has a high DC gain making for excellent DC load and line regulation. The internal voltage loop compensation is located at the output of the transconductance voltage error amplifier.

### Soft-Start

Soft start slowly increases the internal reference voltage when the input voltage or enable input is initially applied. It limits the current surge seen at the input and eliminates output voltage overshoot.

### Current Limit and Over-Temperature Protection

For overload conditions the peak input current is limited. As load impedance decreases and the output voltage falls closer to zero, more power is dissipated internally, raising the device temperature. Thermal protection completely disables switching when internal dissipation becomes excessive, protecting the device from damage. The junction over-temperature threshold is 140°C with 15°C of hysteresis.

### Linear LDO Regulators (OUT1-5)

The advanced circuit design of the linear regulators has been specifically optimized for very fast start-up and shutdown timing. These proprietary LDOs are tailored for superior transient response characteristics. These traits are particularly important for applications which require fast power supply timing.

There are two LDO input pins AVIN1/2 which should be connected to the SYSOUT LDO output pin. All LDO outputs are initially fixed at default levels. The user can program the output voltages for all the LDOs using I<sup>2</sup>C (see Table 8).

The high-speed turn-on capability is enabled through the implementation of a fast start control circuit, which accelerates the power up behavior of fundamental control and feedback circuits within the LDO regulator. Fast turn-off time response is achieved by an active output pull down circuit, which is enabled when an LDO regulator is placed in the shutdown mode. This active fast shutdown circuit has no adverse effect on normal device operation.

## Total Power Solution for Portable Applications

### Input/Output Capacitors

The LDO regulator output has been specifically optimized to function with low cost, low ESR ceramic capacitors. However, the design will allow for operation over a wide range of capacitor types. The input capacitor is shared with all LDO inputs and the step-down converter. A 10 $\mu$ F ceramic output capacitor is recommended for LDO2-5 and a 22 $\mu$ F is recommended for LDO1.

### Current Limit and Over-Temperature Protection

The regulator comes with complete short circuit and thermal protection. The combination of these two internal protection circuits gives a comprehensive safety system to guard against extreme adverse operating conditions.

### I<sup>2</sup>C Serial Interface and Programmability

#### Serial Interface

Many of the features of the AAT3601 can be controlled via the I<sup>2</sup>C serial interface. The I<sup>2</sup>C serial interface is a widely used interface where it requires a master to initiate all the communications with the slave devices. The I<sup>2</sup>C protocol consists of 2 active wire SDA (serial data line) and SCL (serial clock line). Both wires are open drain and require an external pull up resistor to V<sub>CC</sub> (SYSOUT may be used as V<sub>CC</sub>). The SDA pin serves I/O function, and the SCL pin controls and references the I<sup>2</sup>C bus. I<sup>2</sup>C protocol is a bidirectional bus which allows both read and write actions to take place, but the AAT3601 supports the write protocol only. Since the protocol has a dedicated bit for Read or Write access (R/W), when communicating with AAT3601, this bit must be set to "0".

The timing diagram below depicts the transmission protocol.

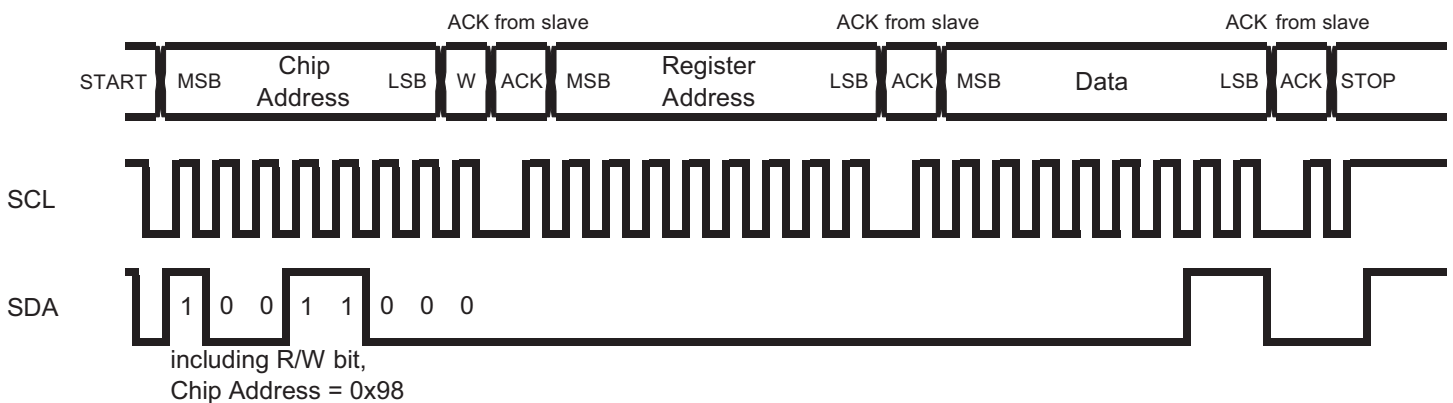

Figure 9: I<sup>2</sup>C Timing Diagram.

**Total Power Solution for Portable Applications**
**START and STOP Conditions**

START and STOP conditions are always generated by the master. Prior to initiating a START condition, both the SDA and SCL pin are idle mode (idle mode is when there is no activity on the bus and SDA and SCL are pulled to  $V_{CC}$  via external resistor). As depicted in Figure 9, a START condition is defined to be when the master pulls the SDA line low and after a short period pulls the SCL line low. A START condition acts as a signal to the ICs that something is about to be transmitted on the BUS.

A STOP condition, also shown in Figure 9, is when the master releases the bus and SCL changes from low to high followed by SDA low to high transition. The master does not issue an ACKNOWLEDGE and releases the SCL and SDA pins.

**Transferring Data**

Every byte on the bus must be 8 bits long. A byte is always sent with a most significant bit first (see Figure 10).

**Figure 10: Bit Order.**

The address is embedded in the first seven bits of the byte. The eighth bit is reserved for the direction of the information flow for the next byte of information. For the AAT3601, this bit must be set to "0". The full 8-bit address including the R/W bit is **0x98** (hex) or **10011000** in binary.

**Acknowledge Bit**

Acknowledge bit is the ninth bit of data. It is used to send back a confirmation to the master that the data has been received properly. For acknowledge to take place, the MASTER must first release the SDA line, then the SLAVE will pull the data line low as shown in Figure 9.

**Serial Programming Code**

After sending the chip address, the master should send an 8-bit data stream to select which register to program and then the codes that the user wishes to enter.

Register 0x00:

Timer	RCHG <sub>1</sub>	RCHG <sub>0</sub>	CHG <sub>2</sub>	CHG <sub>1</sub>	CHG <sub>0</sub>	Term <sub>1</sub>	Term <sub>0</sub>
-------	-------------------	-------------------	------------------	------------------	------------------	-------------------	-------------------

Register 0x01:

Not used	Not used	Not used	Not used	Not used	SYS	LDO1 <sub>1</sub>	LDO1 <sub>0</sub>
----------	----------	----------	----------	----------	-----	-------------------	-------------------

Register 0x02:

LDO5 <sub>1</sub>	LDO5 <sub>0</sub>	LDO4 <sub>1</sub>	LDO4 <sub>0</sub>	LDO3 <sub>1</sub>	LDO3 <sub>0</sub>	LDO2 <sub>1</sub>	LDO2 <sub>0</sub>
-------------------	-------------------	-------------------	-------------------	-------------------	-------------------	-------------------	-------------------

**Figure 11: Serial Programming Register Codes.**

USE_USB Pin	CHG <sub>2</sub>	CHG <sub>1</sub>	CHG <sub>0</sub>	Constant Current Charge $I_{CH\_CC}$	Constant Current Charge as % of ISET current
1	0	0	0	100mA (fixed internally)	(default)
0	0	0	0	800mA (set by ISET resistor)	100% (default)
X	0	0	1	640mA	80%
X	0	1	0	480mA	60%
X	0	1	1	320mA	40%
X	1	0	0	960mA	120%
X	1	0	1	1120mA	140%
X	1	1	0	1280mA	160%
X	1	1	1	1440mA	180%

**Table 4: CHG Bit Setting for the Constant Current Charge Level ( $I_{SET}$  resistor = default 800mA charge current).**

**Total Power Solution for Portable Applications**

Notes concerning the operation of the CHG<sub>2</sub>, CHG<sub>1</sub> and CHG<sub>0</sub> bits or ISET code.

- Once the part is turned on using the  $\overline{\text{EN\_SYS}}$  pin (and there is a BAT and/or CHGIN supply), and data is sent through I<sup>2</sup>C, the I<sup>2</sup>C codes in the registers will always be preserved until the part is shut down using the  $\overline{\text{EN\_PE}}$  (going high) or if the BAT and CHGIN are removed.
- If the part is turned on by connecting CHGIN (and not through  $\overline{\text{EN\_SYS}}$ ), then when the CHGIN is disconnected, the part will shut down and all I<sup>2</sup>C registers will be cleared.

If USE\_USB = L,

- The charge current is set by the ISET code in Register 0x00, bits 2,3,4. (code 000 will equal 100%)
- If the part has been turned on by  $\overline{\text{EN\_SYS}}$  and CHGIN is disconnected then reconnected, it will still contain the code it had before (if it was 60% then it will remain 60%).
- If the part has NOT been turned on by  $\overline{\text{EN\_SYS}}$  and CHGIN is disconnected then reconnected, it will be reset to 100% (since the whole part was shutdown).

If USE\_USB = H,

- ISET Code 000 in Register 0x00, bits 2,3,4 = 100mA. The other codes stay the same as if USE\_USB = H.
- If the part has been turned on by  $\overline{\text{EN\_SYS}}$  and CHGIN is disconnected then reconnected, the ISET code will be forced to 000 and the current will be set to 100mA.
- The next time any I<sup>2</sup>C register is programmed (even if it is not for the ISET code), the ISET code will revert back to what it was before. For example, if the ISET code is set to 010 and USE\_USB = H and the part was turned on with  $\overline{\text{EN\_SYS}}$ , then when CHGIN is disconnected then reconnected, the charger will be set to 100mA. Then if any other command is sent, the ISET code will remain 010.

Term <sub>1</sub>	Term <sub>0</sub>	Termination Current (as % of Constant Current Charge)
0	0	5% (default)
0	1	10%
1	0	15%
1	1	20%

**Table 5: Term Bit Setting for the Termination Current Level.**

RCHG <sub>1</sub>	RCHG <sub>0</sub>	Recharge Threshold
0	0	4.00V (default)
0	1	4.05V
1	0	4.10V
1	1	4.15V

**Table 6: RCHG Bit Setting for the Battery Charger Recharge Voltage Level.**

Timer	Charger Watchdog Timer
0	ON (default)
1	OFF (and reset to zero)

**Table 7: Timer Bit Setting for the Charger Watchdog Timer.**

LDO1 <sub>1</sub>	LDO1 <sub>0</sub>	LDO1 Output Voltage
0	0	3.40V (default)
0	1	2.88V
1	0	3.50V
1	1	3.09V
LDO2 <sub>1</sub>	LDO2 <sub>0</sub>	LDO2 Output Voltage
0	0	3.40V (default)
0	1	2.78V
1	0	3.09V
1	1	1.85V
LDO3 <sub>1</sub>	LDO3 <sub>0</sub>	LDO3 Output Voltage
0	0	1.24V (default)
0	1	1.29V
1	0	1.34V
1	1	2.88V
LDO4 <sub>1</sub>	LDO4 <sub>0</sub>	LDO4 Output Voltage
0	0	1.85V (default)
0	1	1.65V
1	0	1.24V
1	1	1.91V
LDO5 <sub>1</sub>	LDO5 <sub>0</sub>	LDO5 Output Voltage
0	0	1.85V (default)
0	1	1.75V
1	0	1.55V
1	1	1.91V

**Table 8: LDO Bit Setting for LDO Output Voltage Level.**

SYS Bit	SYSOUT Power Source
0	If USE_USB=H, SYSOUT powered from BAT If USE_USB=L, SYSOUT powered from CHGIN
1	SYSOUT always powered from BAT

**Table 9: SYS Bit Setting for SYSOUT Power Path.**



**Total Power Solution for Portable Applications****Layout Guidance**

Figure 12 is the schematic for the evaluation board. The evaluation board has extra components for easy evaluation; the actual BOM need for the system is shown in Table 10. When laying out the PC board, the following layout guideline should be followed to ensure proper operation of the AAT3601:

1. The exposed pad EP must be reliably soldered to PGND/AGND and multilayer GND. The exposed thermal pad should be connected to board ground plane and pins 17 and 31. The ground plane should include a large exposed copper pad under the package with VIAs to all board layers for thermal dissipation.
2. The power traces, including GND traces, the LX traces and the VIN trace should be kept short, direct and wide to allow large current flow. The L1 connection to the LX pins should be as short as possible. Use several via pads when routing between layers.
3. The input capacitors (C1 and C2) should be connected as close as possible to CHGIN (Pin 28) and PGND (Pin 31) to get good power filtering.
4. Keep the switching node LX away from the sensitive OUTBUCK feedback node.
5. The feedback trace for the OUTBUCK pin should be separate from any power trace and connected as closely as possible to the load point. Sensing along a high current load trace will degrade DC load regulation.
6. The output capacitor C4 and L1 should be connected as close as possible and there should not be any signal lines under the inductor.
7. The resistance of the trace from the load return to the PGND (Pin 31) should be kept to a minimum. This will help to minimize any error in DC regulation due to differences in the potential of the internal signal ground and the power ground.

## Total Power Solution for Portable Applications

Quantity	Value	Designator	Footprint	Description
5	10 $\mu$ F	C1, C2, C3, C14, C15	0603	Capacitor - Ceramic - X5R, 6.3V, $\pm$ 20%
2	22 $\mu$ F	C9	0805	Capacitor - Ceramic - 20%, 6.3V, X5R
4	4.7 $\mu$ F	C4, C5, C6, C7, C8	0603	Capacitor - Ceramic - 20%, 6.3V, X5R
3	0.1 $\mu$ F	C10, C11, C12	0402	Capacitor - Ceramic -16V, 10%, X5R
1	0.01 $\mu$ F	C13	0402	Capacitor - Ceramic -16V, 10%, X7R
1	2.2 $\mu$ H	L1	CDRH2D	Inductor - Sumida CDRH2D11NP-2R2NC
9	100K	R5, R8, R20, R21, R22, R23, R25, R26, R27	0402	Resistor - 5%
8	10K	R17, R19, R24, R29, R31, R32, R33, R37	0402	Resistor - 5%
1	1.24K	R18	0402	Resistor - 1%

Table 10: Minimum AAT3601 BOM.

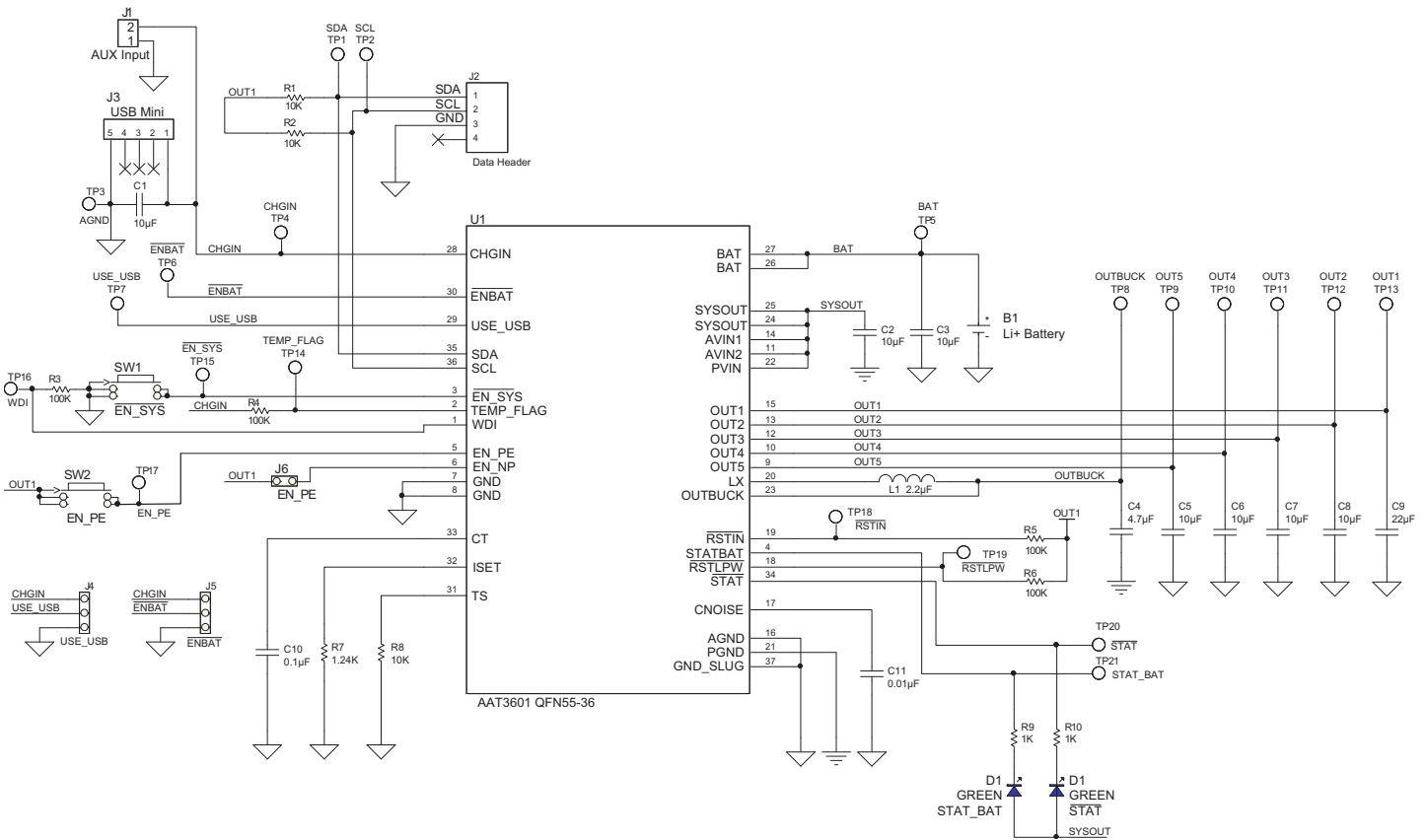

Total Power Solution for Portable Applications

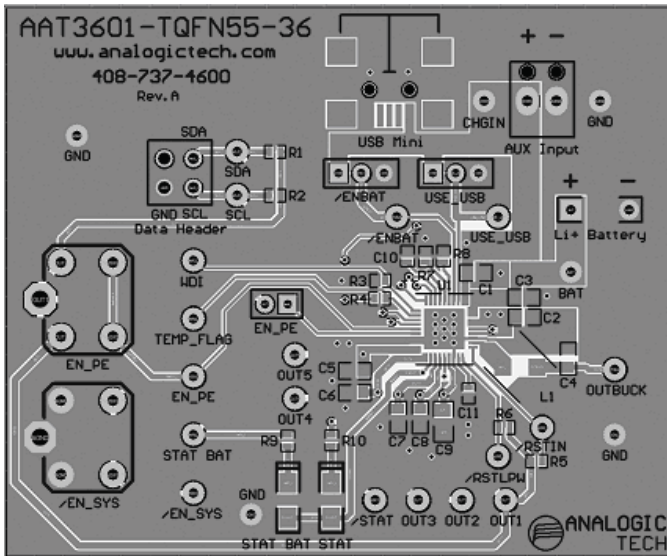

Figure 13: AAT3601 Evaluation Kit Top Layer.

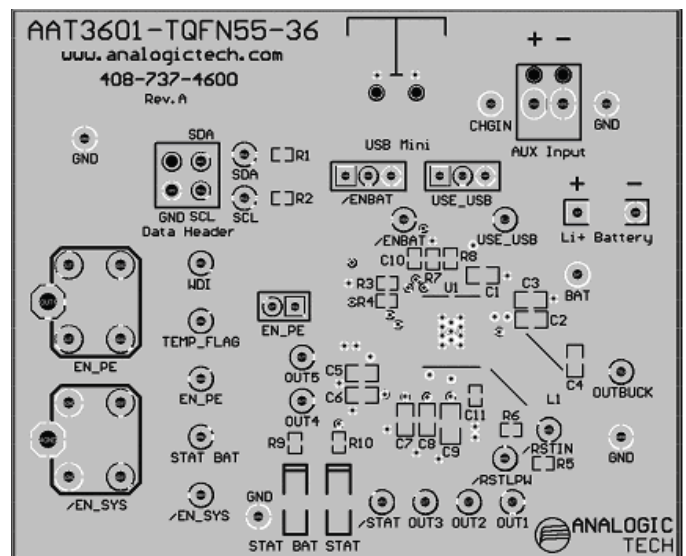

Figure 14: AAT3601 Evaluation Kit Mid1 Layer.

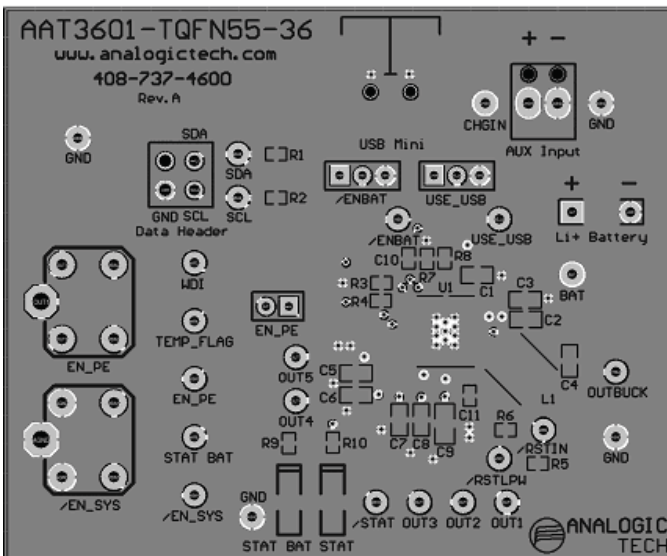

Figure 15: AAT3601 Evaluation Kit Mid2 Layer.

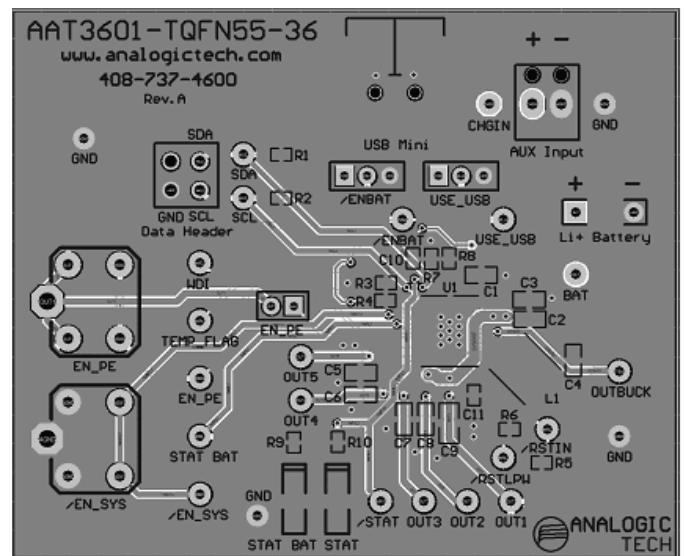

Figure 16: AAT3601 Evaluation Kit Bottom Layer.

## Total Power Solution for Portable Applications

### Ordering Information

Package	Part Marking <sup>1</sup>	Part Number (Tape and Reel) <sup>2</sup>
TQFN55-36	2RXY	<b>AAT3601IIH-T1</b>



All AnalogicTech products are offered in Pb-free packaging. The term "Pb-free" means semiconductor products that are in compliance with current RoHS standards, including the requirement that lead not exceed 0.1% by weight in homogeneous materials. For more information, please visit our website at <http://www.analogictech.com/about/quality.aspx>.

### Packaging Information

#### TQFN55-36

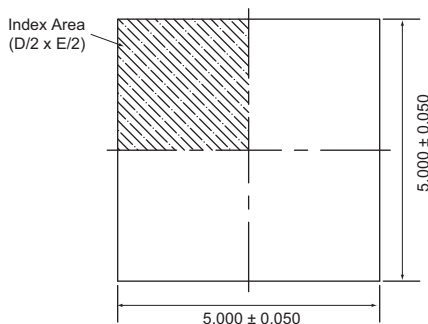

Top View

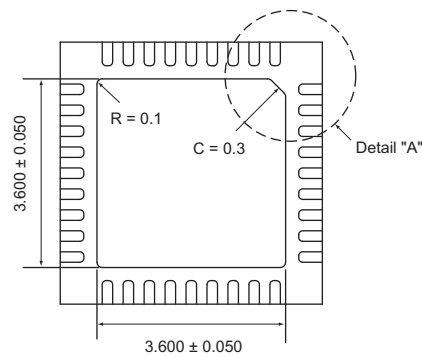

Bottom View

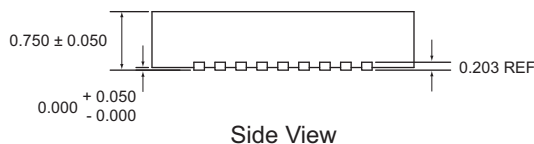

Side View

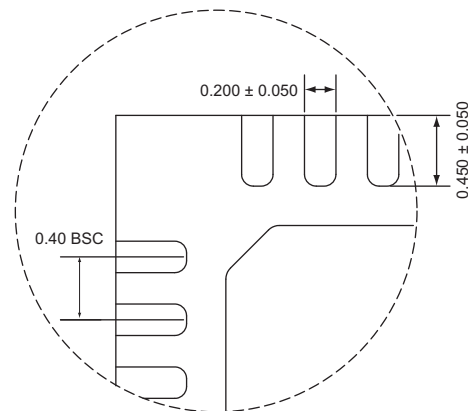

Detail "A"

All dimensions in millimeters.

1. XYY = assembly and date code.
2. Sample stock is generally held on part numbers listed in **BOLD**.
3. The leadless package family, which includes QFN, TQFN, DFN, TDFN and STDN, has exposed copper (unplated) at the end of the lead terminals due to the manufacturing process. A solder fillet at the exposed copper edge cannot be guaranteed and is not required to ensure a proper bottom solder connection.

**Total Power Solution for Portable Applications**

**Advanced Analogic Technologies, Inc.**  
3230 Scott Boulevard, Santa Clara, CA 95054  
Phone (408) 737-4600  
Fax (408) 737-4611



© Advanced Analogic Technologies, Inc.  
AnalogicTech cannot assume responsibility for use of any circuitry other than circuitry entirely embodied in an AnalogicTech product. No circuit patent licenses, copyrights, mask work rights, or other intellectual property rights are implied. AnalogicTech reserves the right to make changes to their products or specifications or to discontinue any product or service without notice. Except as provided in AnalogicTech's terms and conditions of sale, AnalogicTech assumes no liability whatsoever, and AnalogicTech disclaims any express or implied warranty relating to the sale and/or use of AnalogicTech products including liability or warranties relating to fitness for a particular purpose, merchantability, or infringement of any patent, copyright or other intellectual property right. In order to minimize risks associated with the customer's applications, adequate design and operating safeguards must be provided by the customer to minimize inherent or procedural hazards. Testing and other quality control techniques are utilized to the extent AnalogicTech deems necessary to support this warranty. Specific testing of all parameters of each device is not necessarily performed. AnalogicTech and the AnalogicTech logo are trademarks of Advanced Analogic Technologies Incorporated. All other brand and product names appearing in this document are registered trademarks or trademarks of their respective holders.