



Features

- High efficiency up to 91% at 230VAC
- Universal AC input voltage range: 90-264 VAC
- Active power factor correction
- Over temperature, output overvoltage, overcurrent and short circuit protection
- Low conducted and radiated EMI (EN 55022 cl A)
- Safety approval to UL/CSA/EN/IEC60950-1
- High power density design: 16 W/in³
- Compact size: 3.0 (W) x 1.5 (H) x 5.0 (L) inches
- ROHS-compliant

Applications

- Telecom, datacom, industrial equipment.

Description

This is a compact and efficient series of AC-DC power supplies suited for telecom, datacom and many other applications. this family meets the international information technology safety standards with the CE-Mark for the European Low Voltage Directive (LVD). their high efficiency allows a very minimal power loss in end equipment, resulting in higher reliability, ease of thermal management and regulatory approvals for an environmentally friendly end product.

Content

1 ORDERING INFORMATION.....	2	7.1 OVERVOLTAGE PROTECTION	8
2 OVERVIEW.....	2	7.2 CURRENT LIMITATION	8
3 ABSOLUTE MAXIMUM RATINGS	3	8 POWER GOOD SIGNAL	9
4 ENVIRONMENTAL AND MECHANICAL	3	9 ELECTROMAGNETIC COMPATIBILITY	9
5 INPUT SPECIFICATIONS	3	9.1 IMMUNITY	9
5.1 INPUT FUSE	4	9.2 EMISSION	10
5.2 INRUSH CURRENT	4	10 SAFETY / APPROVALS	10
5.3 INPUT UNDER-VOLTAGE	4	11 MECHANICAL	10
5.4 POWER FACTOR CORRECTION	4	11.1 DIMENSIONS	10
5.5 EFFICIENCY	4	11.2 CONNECTIONS	13
6 OUTPUT SPECIFICATIONS	5		
7 PROTECTION.....	8		

1 ORDERING INFORMATION

Product Family	Output Power	Dash	# Outputs	Standard: 0 S-Type: 1-9	Vo-Voltage	RoHS compliant
ABC400-10XX	400W	-	1	0	12VDC / 24VDC / 48VDC	G

2 OVERVIEW

The ABC400-10XXG is a high efficiency and high power density AC to DC power supply. It incorporates interleaved transition mode PFC converter and well proven two-FET forward converter, providing increased system reliability

and high efficiency. with around 1m/s system air cooling, ABC400-1012G can delivery up to 360W continuous output power and 408W for ABC400-1024G and ABC400-1048G

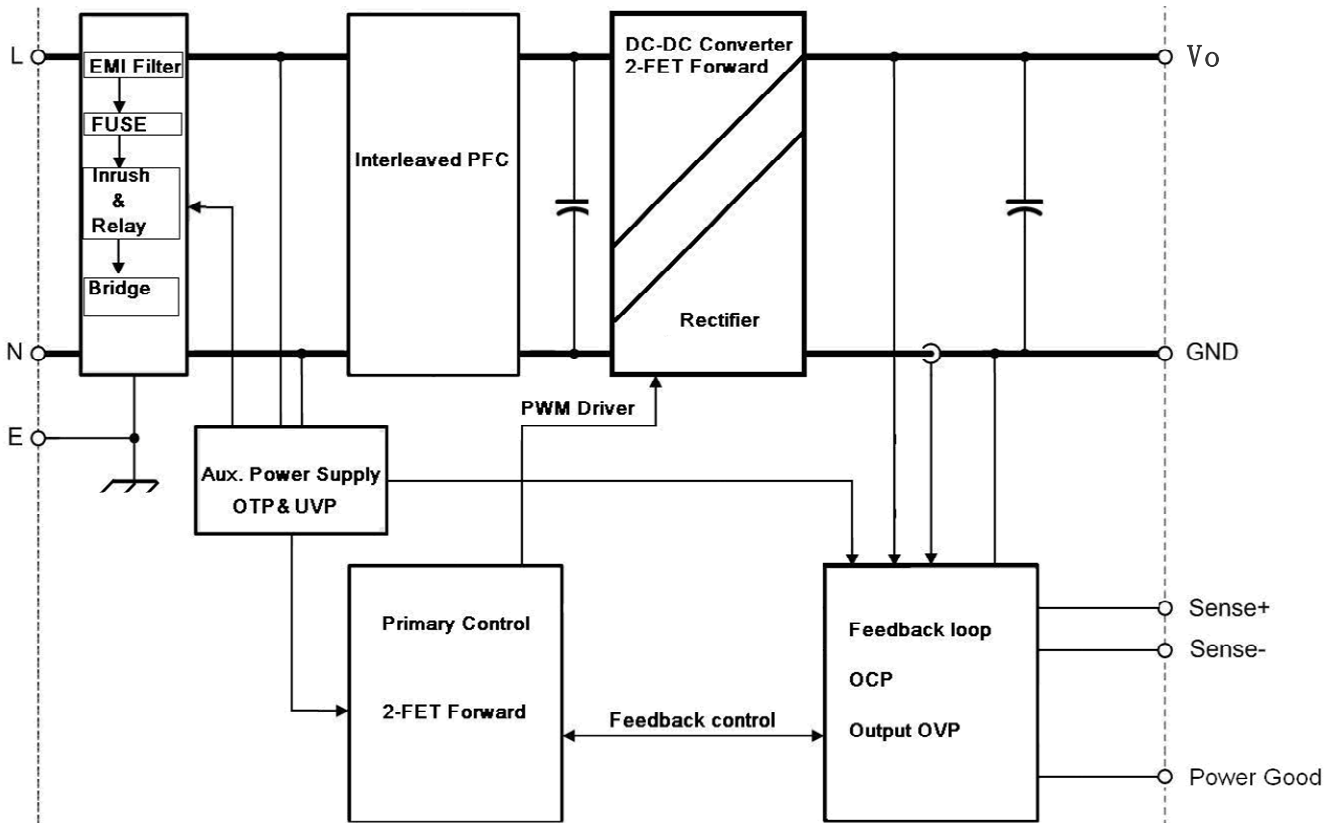

Figure 1: ABC400-10XXG block diagram

3 ABSOLUTE MAXIMUM RATINGS

Stresses in excess of the absolute maximum ratings may cause performance degradation, adversely affect long-term reliability, and cause permanent damage to the supply.

Parameter		Conditions / Description	Min	Nom	Max	Unit
$V_{i\max}$	Max continuous input	Continuous			264	VAC
		Transient, 60 ms			300	VAC

4 ENVIRONMENTAL AND MECHANICAL

Parameter		Conditions / Description	Min	Nom	Max	Unit
T_A	Ambient temperature	$V_{i\min}$ to $V_{i\max}$, $I_{o\text{ nom}}$, $I_{SB\text{ nom}}$	-10		+50	°C
$T_{A\text{ ext}}$	Extended temp range	Derated output	+50		+70	°C
T_S	Storage temperature	Non-operational	-40		+85	°C
	Dimensions	Width		76.2		mm
		Height		38.1		mm
		Depth		127.0		mm
M	Weight			0.5		kg

5 INPUT SPECIFICATIONS

General Condition: $T_A = -10 \dots 50$ °C unless otherwise noted.

Active fan air cooling required: 200 LFM (1 m/s)

Parameter		Conditions / Description	Min	Nom	Max	Unit
$V_{i\text{ nom}}$	Nominal input voltage		100		240	VAC
V_i	Input voltage ranges	Normal operating ($V_{i\min}$ to $V_{i\max}$)	90		264	VAC
$I_{i\max}$	Max input current				6.5	$A_{\text{ rms}}$
$I_{i\text{ p}}$	Inrush current limitation	$V_{i\text{ nom}}=115\text{VAC}$, $T=25^\circ\text{C}$ (see Figure 2)			30	$A_{\text{ p}}$
		$V_{i\text{ nom}}=230\text{VAC}$, $T=25^\circ\text{C}$ (see Figure 3)			60	
F_i	Input frequency		47	50/60	63	Hz
PF	Power factor	$V_{i\text{ nom}}=264\text{VAC}$, $> 0.5 I_{o\text{ nom}}$	0.9			W/VA
$V_{i\text{ on}}$	Turn-on input voltage ¹⁾	Ramping up	80		88	VAC
$V_{i\text{ off}}$	Turn-off input voltage ¹⁾	Ramping down	72		80	VAC
η	Efficiency	$V_{i\text{ nom}}=230\text{VAC}$, $0.5 \cdot I_{o\text{ nom}}$, $V_{o\text{ nom}}$, $T_A = 25^\circ\text{C}$		89		%
		$V_{i\text{ nom}}=230\text{VAC}$, $1.0 \cdot I_{o\text{ nom}}$, $V_{o\text{ nom}}$, $T_A = 25^\circ\text{C}$		90		
$T_{\text{ hold}}$	Hold-up Time	After last AC zero point, V_o within regulation, $V_i = 115\text{ VAC}$, $P_{o\text{ nom}}$	16			ms

¹⁾ The power supply is provided with a minimum hysteresis of 8 V during turn-on and turn-off within the ranges.

5.1 INPUT FUSE

A slow-blow 8A input fuses (5 × 20 mm) in series with live line inside the power supply protects against severe defects. the fuse and a VDR form together with the input filter an effective protection against high input transients.

5.2 INRUSH CURRENT

The AC-DC power supply exhibits an X-capacitance of only 1.47 μF, resulting in a low and short peak current, when the supply is connected to the mains. the internal bulk capacitor will be charged through a power resistor which will limit the inrush current (see Figure 2 and 3).

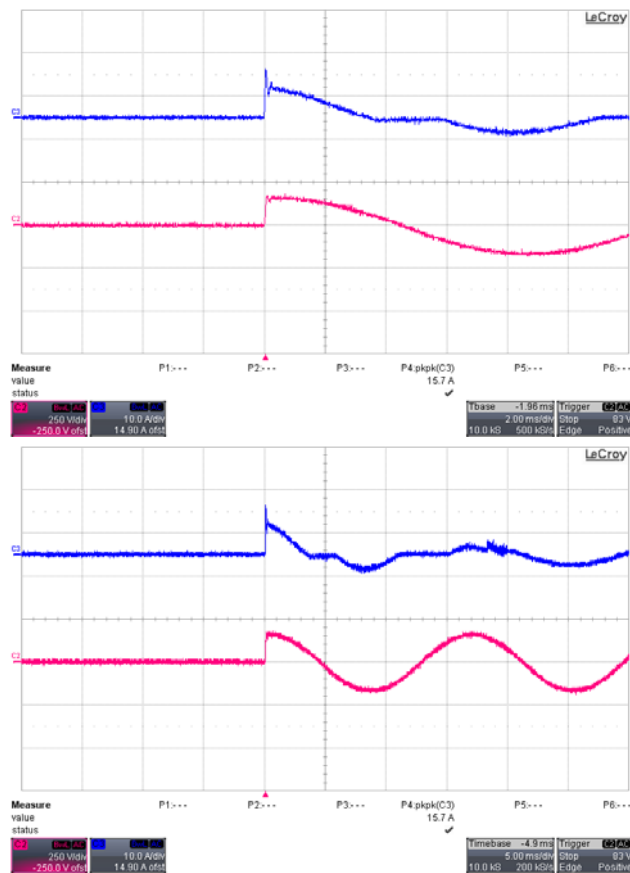

Figure 2: Inrush current, $V_{in} = 115\text{Vac}$, 90°
CH2: V_{in} (250V/div), CH3: I_{in} (10A/div)

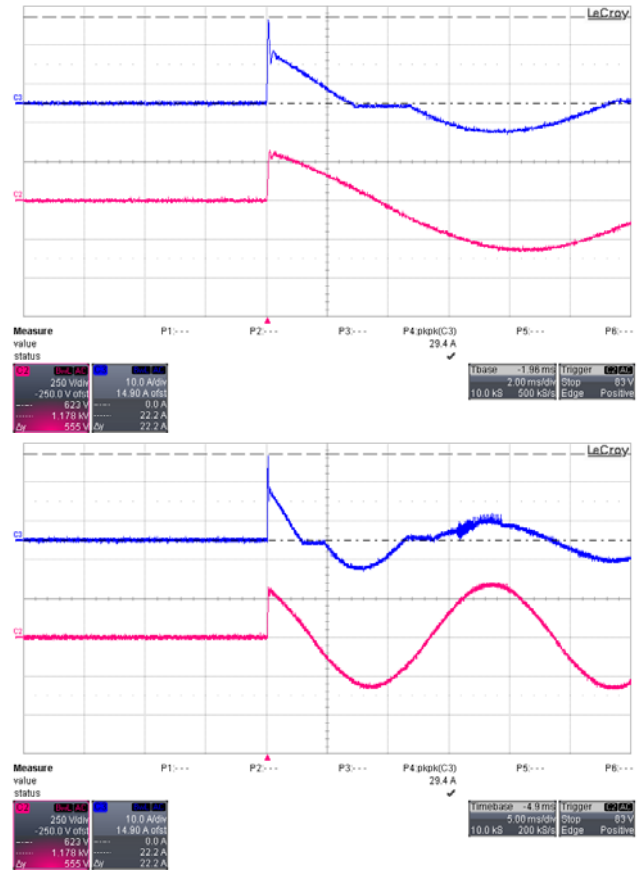

Figure 3: Inrush current, $V_{in} = 230\text{Vac}$, 90°
CH2: V_{in} (250V/div), CH3: I_{in} (10A/div)

5.3 INPUT UNDER-VOLTAGE

If the sinusoidal input voltage stays below the input under voltage lockout threshold V_{lon} , the supply will be inhibited. Once the input voltage returns within the normal operating range, the supply will return to normal operation again.

5.4 POWER FACTOR CORRECTION

Power factor correction (PFC) is achieved by controlling the input current waveform synchronously with the input voltage. A specified PFC controller is implemented in the interleaved transition mode topology giving outstanding PFC results over a wide input voltage and load ranges. The input current will follow the shape of the input voltage.

5.5 EFFICIENCY

The high efficiency (see Figure 4, 5 and 6) is achieved by using state-of-the-art silicon power devices in conjunction with interleaved transition mode PFC topology minimizing

switching losses. Synchronous rectifiers on the output reduce the losses in the high current output path for ABC400-1012G.

Schottky diode and ultra fast diode are used as rectifiers for ABC400-1024G and ABC400-1048G due to the high output voltage level.

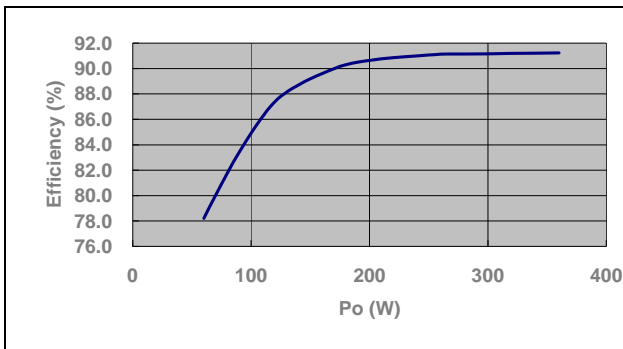

Figure 4: Efficiency vs. Output Power at 230VAC, ABC400-1012G

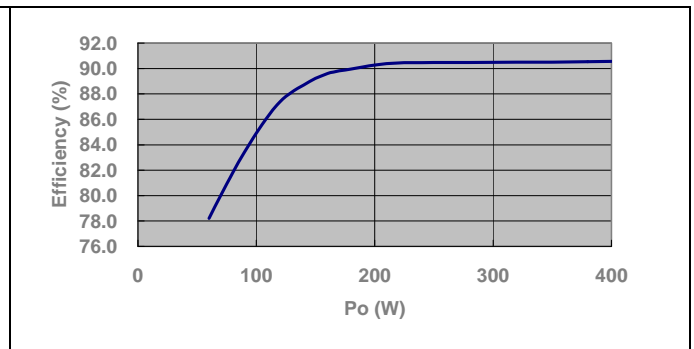

Figure 5: Efficiency vs. Output Power at 230VAC, ABC400-1024G

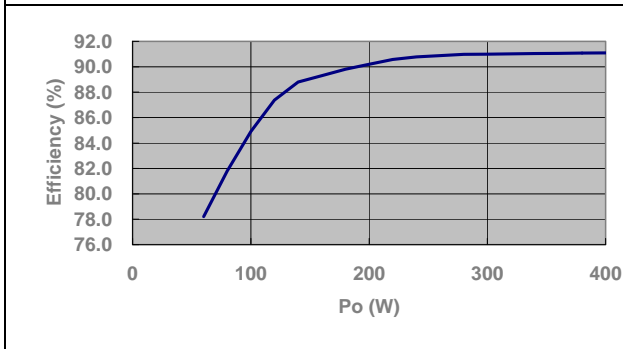

Figure 6: Efficiency vs. Output Power at 230VAC, ABC400-1048G

6 OUTPUT SPECIFICATIONS

General Condition: $T_A = -10 \dots +50 \text{ }^\circ\text{C}$ unless otherwise noted.

Active fan air cooling required: 200 LFM (1 m/s)

Parameter	Conditions / Description	Min	Nom	Max	Unit	
Main Output V_o						
V_o	Nominal output voltage	$0.5 \cdot I_o, T_{amb} = 25 \text{ }^\circ\text{C}$	ABC400-1012G	12.0		VDC
			ABC400-1024G	24.0		VDC
			ABC400-1048G	48.0		VDC

V _{o set}	Output set point accuracy	0.5 · I _o , T _{amb} = 25 °C	ABC400-1012G	-50		50	mV
			ABC400-1024G	-75		75	mV
			ABC400-1048G	-150		150	mV
P _{o nom}	Nominal output power		ABC400-1012G	0	276	360	W
			ABC400-1024G	0	312	408	W
			ABC400-1048G	0	312	408	W
I _{o nom}	Nominal output current		ABC400-1012G	0	23	30	A
			ABC400-1024G	0	13	17	A
			ABC400-1048G	0	6.5	8.5	A
V _{o p-p}	Output ripple voltage	V _{o nom} , I _{o nom} , 20 MHz BW	ABC400-1012G		60	120	mVpp
			ABC400-1024G		80	240	mVpp
			ABC400-1048G		150	480	mVpp
dV _{o Load}	Load regulation	V _i = V _{i nom} , 0 - 100 % I _{o nom}	ABC400-1012G	-360	50	360	mV
			ABC400-1024G	-720	80	720	mV
			ABC400-1048G	-1440	130	1440	mV
dV _{o Line}	Line regulation	V _i = V _{i min} ...V _{i max}	ABC400-1012G	-360	80	360	mV
			ABC400-1024G	-720	120	720	mV
			ABC400-1048G	-1440	150	1440	mV
dV _{dyn}	Dynamic regulation load	ΔI _o = 50% I _{o nom} , I _o = 50 ... 100% I _{o nom} , dI _o /dt = 1 A/μs, recovery within 5% of V _{o nom}	ABC400-1012G	-0.6	0.25	0.6	V
			ABC400-1024G	-1.2	0.45	1.2	V
			ABC400-1048G	-2.4	0.7	2.4	V
t _{rec}	Recovery time				2	ms	
t _{delay}	Turn-on Delay	Time required for output within regulation after initial application of AC input @90 Vac	0	1	2	Sec	
t _{rise}	Turn on Rise time	V _o = 10...90% V _{o nom}	ABC400-1012G			20	ms
			ABC400-1024G			20	ms
			ABC400-1048G			30	ms
C _{Load}	Capacitive loading		ABC400-1012G			6600	μF
			ABC400-1024G			3740	μF
			ABC400-1048G			1870	μF

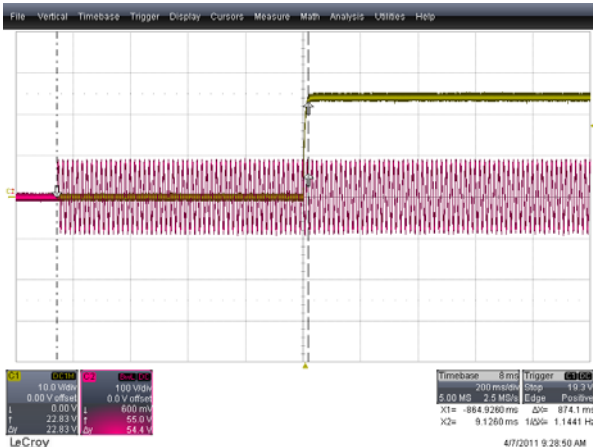

Figure 7: Turn-On AC Line 115 VAC, full load (200 ms/div)
CH1: V_o (10 V/div) CH2: V_{in} (100 V/div)

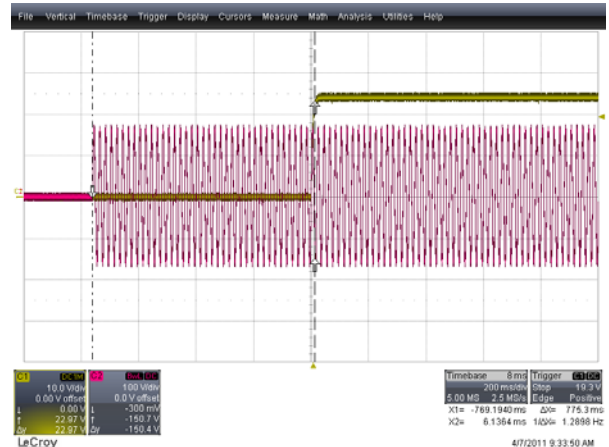

Figure 8: Turn-On AC Line 230 VAC, full load (200 ms/div)
CH1: V_o (10 V/div) CH2: V_{in} (100 V/div)

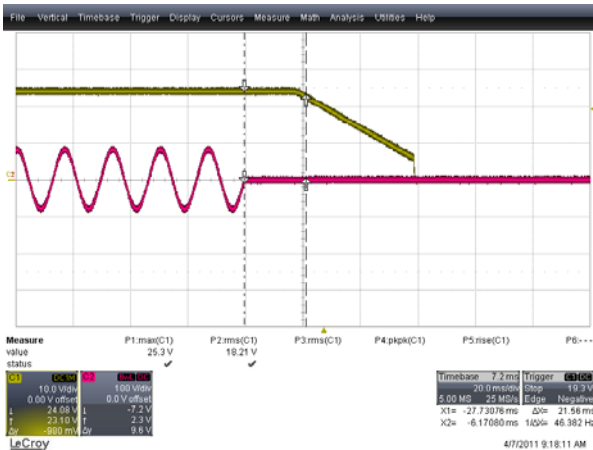

Figure 9: Turn-Off AC Line 115 VAC, full load (10 ms/div)
CH1: V_o (10 V/div) CH2: V_{in} (100 V/div)

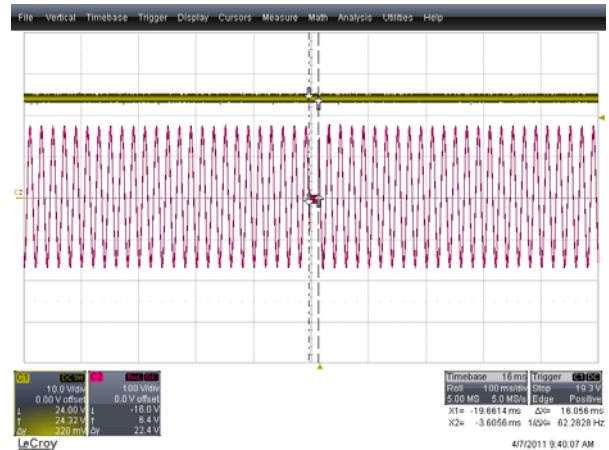

Figure 10: AC drop out 16ms (100 ms/div)
CH1: V_o (10 V/div) CH2: V_{in} (100 V/div)

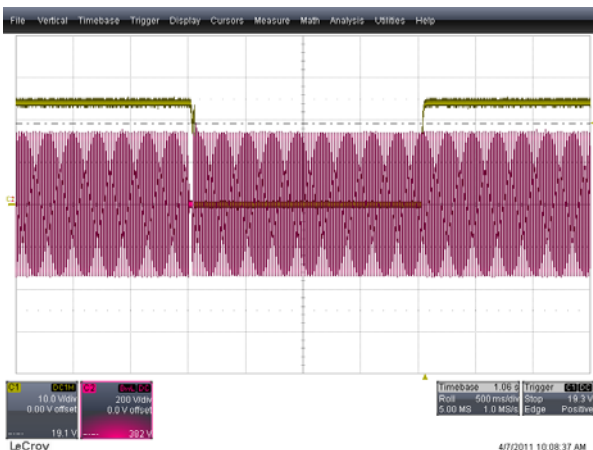

Figure 11: AC drop out 30ms (500 ms/div), V_o restart
CH1: V_o (10 V/div) CH2: V_{in} (200 V/div)

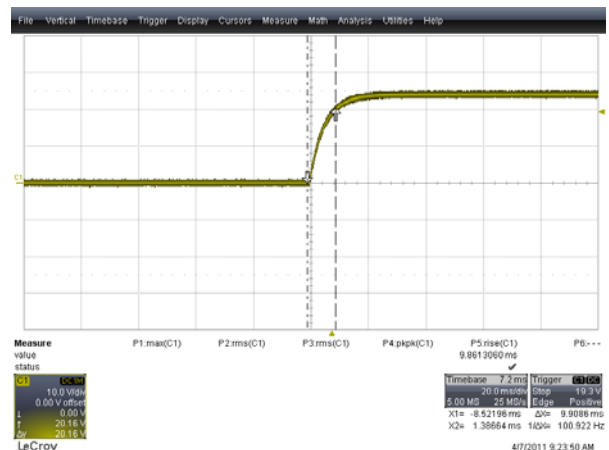

Figure 12: V_o rise time at 115VAC (20 ms/div)
CH1: V_o (10 V/div)

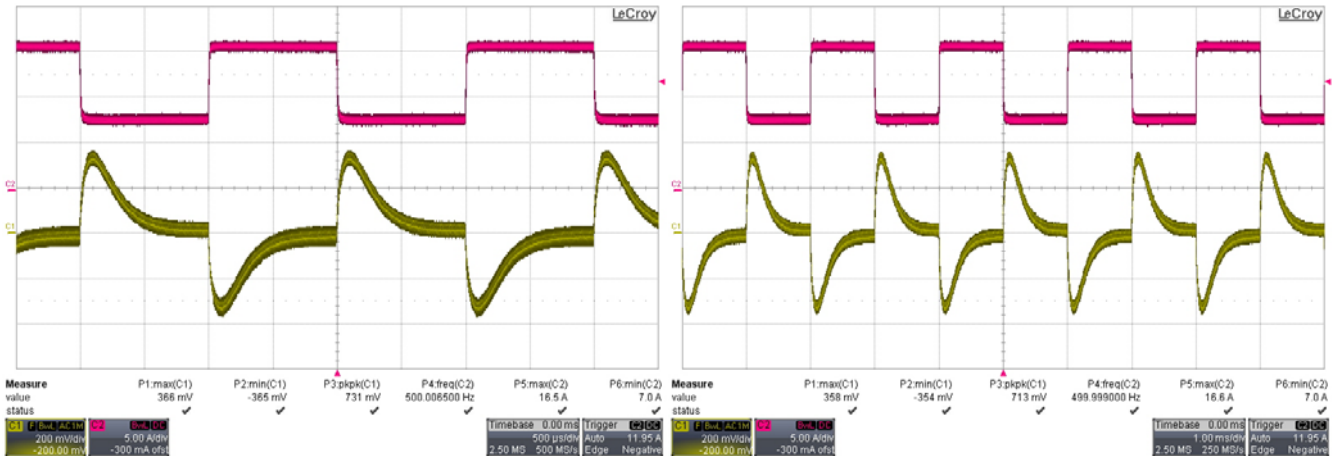

Figure 13: Load transient V_o (500 μ s/div), 8.5A \leftrightarrow 17A 2A/ μ s
CH1: V_o (200mV/div) CH2: I_o (5.0 A/div)

Figure 14: Load transient V_o (1.0ms/div), 8.5A \leftrightarrow 17A, 2A/ μ s
CH1: V_o (200 mV/div) CH2: I_o (5 A/div)

7 PROTECTION

Parameter		Conditions / Description	Min	Nom	Max	Unit	
F	Input fuses (L only)	Not user accessible, time lag characteristic		8.0		A	
V_o ov	OV threshold	ABC400-1012G	14.0		16.0	VDC	
		ABC400-1024G	28.0		32.0	VDC	
		ABC400-1048G	53		57	VDC	
I_o lim	Current limit	$V_i > 90$ VAC, -10 °C $< T_a < 50$ °C	ABC400-1012G	31.5	33.0	39.0	A
		ABC400-1024G	20.0	21.0	23.0	A	
		ABC400-1048G	8.9	10	11.1	A	
T_{SD}	Over temperature on heat sinks	Automatic shut-down		100		°C	

7.1 OVERVOLTAGE PROTECTION

The AC-DC power supply provides a fixed threshold overvoltage (OV) protection implemented with a HW comparator. Once an OV condition has been triggered, the supply will shut down and latch the fault condition. the latch can be unlocked by disconnecting the supply from the AC mains only.

7.2 CURRENT LIMITATION

The main output current limitation will decrease with linear derating to 50% at 70 °C if the ambient (inlet) temperature increases beyond 50 °C (see Figure 15).

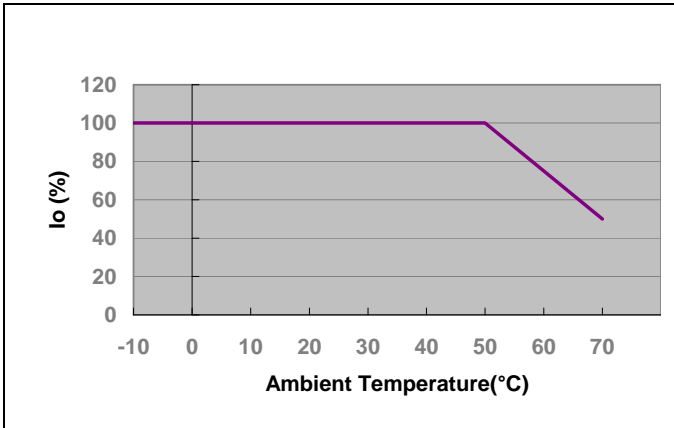

Figure 15: Output Current Limitation Curve

8 POWER GOOD SIGNAL

The Out-OK output gives a status indication of the converter and the output voltages. It can be used for control functions such as data protection, central system monitoring or as a part of a self-testing system. Connecting the Out-OK as shown in Figure 16, $V_{ok} < 1.0\text{ V}$ indicates that the output voltage(s) of the converter are within the range.

Note: using the potentiometer, the monitor level tracks the programmed output voltage. In an error condition, if the output voltage is out of range due to overload or an external overvoltage, V_{ok} will approach V_p . The output is formed by an NPN transistor. The signal is isolated from the output.

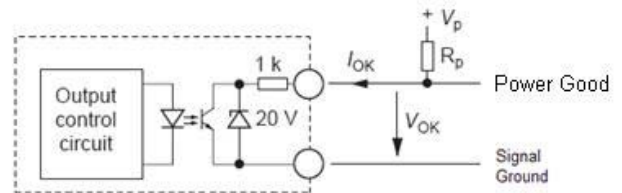

Figure 16: Power Good signal

Power Good Signal Description:

1. O/P V OK – Signal Low, Opto conducting, (max sink current 0.5mA)
2. O/P V Bad – Signal High, Opto opening, (max leakage current 25 $\mu\text{ A}$)

9 ELECTROMAGNETIC COMPATIBILITY

9.1 IMMUNITY

Note: Most of the immunity requirements are derived from EN 55024:1998/A2:2003.

Test	Standard / Description	Criteria
ESD Contact Discharge	EN 61000-4-2, Level 2	A
RF Susceptibility	EN 61000-4-3, Level 3	A
Fast Transient/Burst	EN 61000-4-4, Level 3	B
Surge	EN 61000-4-5, Class 3	B
RF Conducted Immunity	EN 61000-4-6, Class 3	A
Voltage Dips and Interruptions	EN 61000-4-11	C
Magnetic Fields	EN 61000-4-8	A

9.2 EMISSION

Test	Standard / Description	Criteria
Conducted Emission	EN55022 / CISPR 22: 0.15 ... 30 MHz, QP and AVG, single unit	Class A 6 dB Margin
Radiated Emission	EN55022 / CISPR 22: 30 MHz ... 1 GHz, QP, single unit	Class A 6 dB Margin
Harmonic Emissions	IEC61000-3-2, Vin = 100 VAC/ 60 Hz, 100% Load	Class A
	IEC61000-3-2, Vin = 240 VAC/ 50 Hz, 100% Load	Class A
Voltage Fluctuation and Flicker	EN61000-3-3	PASS
Canadian Communications Radio Interference	ICES-003	NA
Rules for Unintentional Radiations	FCC Part 15, Sub Part-B	NA
Taiwan EMI Regulations	BSMI: CNS 13438 (95)	NA

10 SAFETY / APPROVALS

Maximum electric strength testing is performed in the factory according to IEC/EN 60950, and UL 60950. input-to-output electric strength tests should not be repeated in the field. Power-One will not honor any warranty claims resulting from electric strength field tests.

Parameter		Description / Conditions	Min	Nom	Max	Unit
	Agency Approvals	UL 60950-1 Second Edition CSA-C22.2 No. 60950-1-03 Second Edition IEC 60950-1:2005 EN 60950-1:2006 CE Mark for LVD CB Approval	Approved by independent body (see CE Declaration)			
	Insulation Safety Rating	Input / Case	Basic			
		Input / Output	Reinforced			
		Output / Case	Functional			
d_c	Creepage / clearance	Primary (L/N) to protective earth (PE)	According to safety standard			mm
		Primary to secondary				mm
	Electrical strength test	Input to case	2121			VDC
		Input to output	4242			VDC
		Output and Signals to case	707			VDC

11 MECHANICAL

11.1 DIMENSIONS

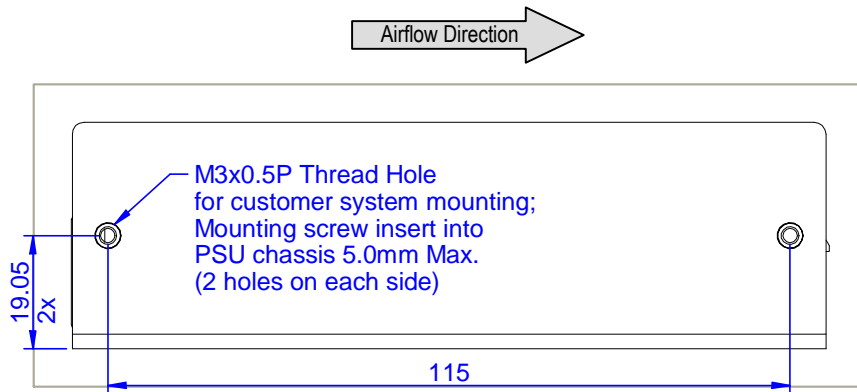
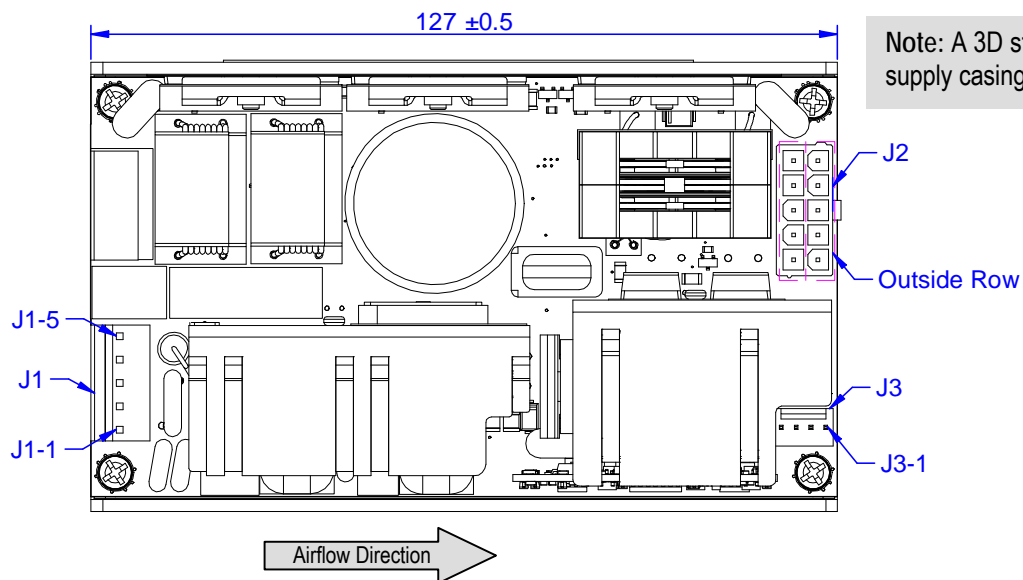

Figure 17: Side view 1



Note: A 3D step file of the power supply casing is available on request.

Figure 18: Top view

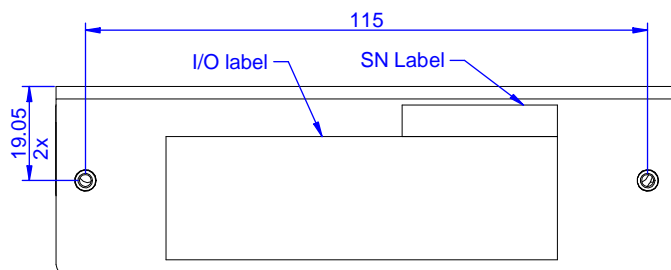

Figure 19: Side view 2

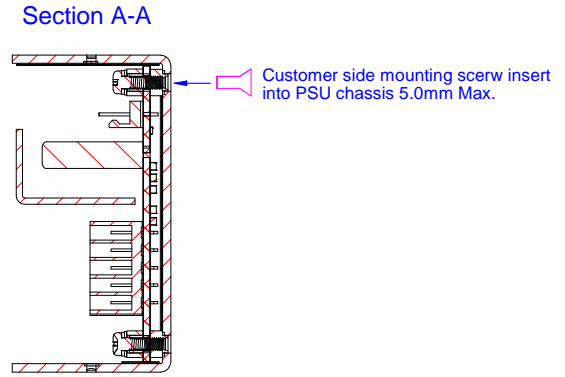
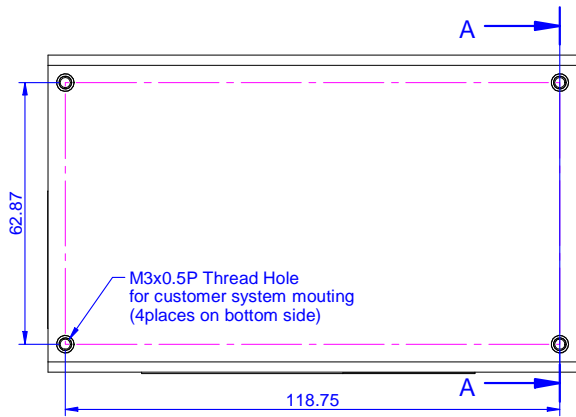

Figure 20: Bottom view 2

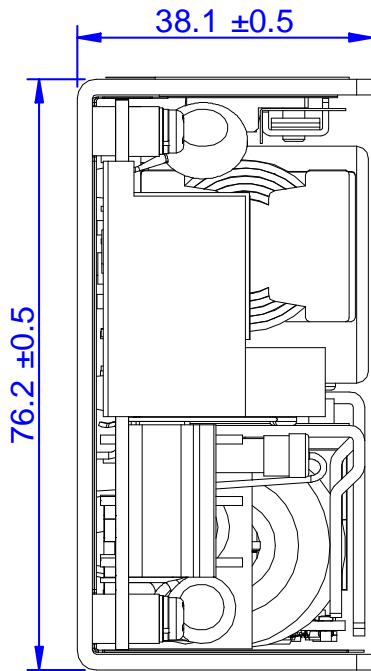

Figure 21: Front view

11.2 CONNECTIONS

Pin	Name	Description
Input Connector J1		
J1- 1	Earth	AC Input Earth
J1- 2	Not fitted	NA
J1- 3	Live	AC Input Live
J1- 4	Not fitted	NA
J1- 5	Neutral	AC Input Neutral
Output Connector J2		
J2-outside row	+Vo	+12V / +24V / +48V Output
J2-inside row	-Vo	+12V / +24V / +48V Output Return
Signal Connector J3		
J3- 1	-Vo Sense	Output Negative Sense
J3- 2	+Vo Sense	Output Positive Sense
J3- 3	Power Good	Power Good Signal
J3- 4	Power Good Return	Power Good Signal Return

Connector Mating Parts (Molex or equivalent)

Connector	Housing	Crimp Terminal	Wire Gauge
J1	09-50-3051	08-50-0105	AWG#18
J2	39-01-2105	44476-3112	AWG#16
J3	22-01-3047	08-50-0113	AWG#22-30

Copyright © 2010 Power-One Inc. All rights reserved. Words and logos that are identified as trademarks and/or service marks are, unless noted otherwise, the trademarks and service marks of Power-One Inc. in the U.S. and other countries. All other product or service names are the property of their respective holders. Power-One products are protected under numerous U.S. and foreign patents and pending applications, maskwork rights, and copyrights. Power-One reserves the right to make changes to any products and services at any time without notice. Power-One assumes no responsibility or liability arising out of the application or use of any information, product, or service described herein except as expressly agreed to in writing by Power-One Inc.

1. NUCLEAR AND MEDICAL APPLICATIONS - Power-One products are not designed, intended for use in, or authorized for use as critical components in life support systems, equipment used in hazardous environments, or nuclear control systems without the express written consent of the respective divisional president of Power-One, Inc.
2. TECHNICAL REVISIONS - The appearance of products, including safety agency certifications pictured on labels, may change depending on the date manufactured. Specifications are subject to change without notice.