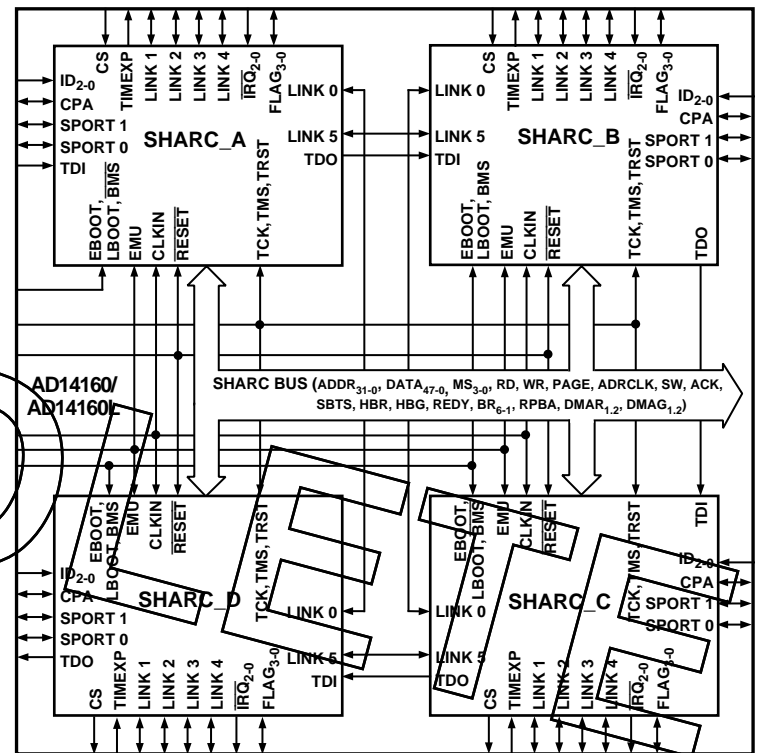

**AD14160/AD14160L**
**PERFORMANCE FEATURES**

**ADSP-21060 Core Processor (. . . × 4)**  
**480 MFLOPS Peak, 320 MFLOPS Sustained**  
**25 ns Instruction Rate, Single-Cycle**  
**Instruction Execution—Each of Four Processors**  
**16 Mbit Shared SRAM (Internal to SHARCs)**  
**4 Gigawords Addressable Off-Module Memory**  
**Sixteen 40 Mbyte/s Link Ports (Four per SHARC)**  
**Eight 40 Mbit/s Independent Serial Ports (Two from Each SHARC)**  
**5 V and 3.3 V Operation**  
**32-Bit Single Precision and 40-Bit Extended Precision IEEE Floating Point Data Formats, or 32-Bit Fixed Point Data Format**  
**IEEE JTAG Standard 1149.1 Test Access Port and On-Chip Emulation**

**PACKAGING FEATURES**

**452-Lead Ceramic Ball Grid Array (CBGA)**  
**1.85" (47 mm) Body Size**  
**0.200" Max Height**  
**0.050" Ball Pitch**  
**29 Grams (typical)**  
 $\theta_{JC} = 0.36^{\circ}\text{C/W}$

**FUNCTIONAL BLOCK DIAGRAM**

**GENERAL DESCRIPTION**

The AD14160/AD14160L Quad-SHARC Ceramic Ball Grid Array (CBGA) puts the power of the first generation AD14060 (CQFP) DSP multiprocessor into a very high density ball grid array package; now with additional link and serial I/O pinned out, beyond that from the CQFP package. The core of the multiprocessor is the ADSP-21060 DSP microcomputer. The AD14x60 modules have the highest performance—density and lowest cost— performance ratios of any in their class. They are ideal for applications requiring higher levels of performance and/or functionality per unit area.

The AD14160/AD14160L takes advantage of the built-in multiprocessing features of the ADSP-21060 to achieve 480 peak MFLOPS with a single chip type, in a single package. The on-chip SRAM of the DSPs provides 16 Mbits of on-module shared SRAM. The complete shared bus (48 data, 32 address) is also brought off-module for interfacing with expansion memory or other peripherals.

SHARC is a registered trademark of Analog Devices, Inc.

**REV. A**

Information furnished by Analog Devices is believed to be accurate and reliable. However, no responsibility is assumed by Analog Devices for its use, nor for any infringements of patents or other rights of third parties which may result from its use. No license is granted by implication or otherwise under any patent or patent rights of Analog Devices.

The ADSP-21060 link ports are interconnected to provide direct communication among the four SHARCs as well as high speed off-module access. Internally, links connect the SHARC in a ring. Externally, each SHARC has a total of 160 Mbytes/s link port bandwidth.

Multiprocessor performance is enhanced with embedded power and ground planes, matched impedance interconnect, and optimized signal routing lengths and separation. The fully tested and ready-to-insert multiprocessor also significantly reduces board space.

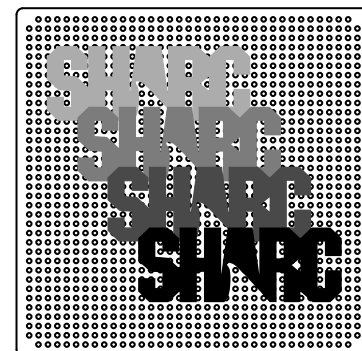

# AD14160/AD14160L

## DETAILED DESCRIPTION

### Architectural Features

#### ADSP-21060 Core

The AD14160/AD14160L is based on the powerful ADSP-21060 (SHARC) DSP chip. The ADSP-21060 SHARC combines a high performance floating-point DSP core with integrated, on-chip system features including a 4 Mbit SRAM memory, host processor interface, DMA controller, serial ports, and both link port and parallel bus connectivity for glueless DSP multiprocessing, (see Figure 1). It is fabricated in a high speed, low power CMOS process, and has a 25 ns instruction cycle time. The arithmetic/ logic unit (ALU), multiplier and shifter all perform single-cycle instructions, and the three units are arranged in parallel, maximizing computational throughput.

The SHARC features an enhanced Harvard architecture in which the data memory (DM) bus transfers data, and the program memory (PM) bus transfers both instructions and data. There is also an on-chip instruction cache which selectively caches only those instructions whose fetches conflict with the PM bus data accesses. This combines with the separate program and data memory buses to enable three-bus operation for fetching an instruction and two operands, all in a single cycle. The SHARC also contains a general purpose data register file, which

is a 10-port, 32-register (16 primary, 16 secondary) file. Each SHARC's core also implements two data address generators (DAGs), implementing circular data buffers in hardware. The DAGs contain sufficient registers to allow the creation of up to 32 circular buffers. The 48-bit instruction word accommodates a variety of parallel operations, for concise programming. For example, the ADSP-21060 can conditionally execute a multiply, an add, a subtract, and a branch, all in a single instruction.

The SHARCs contain 4 Mbits of on-chip SRAM each, organized as two blocks of 2 Mbits, which can be configured for different combinations of code and data storage. The memory can be configured as a maximum of 128K words of 32-bit data, 256K words of 16-bit data, 80K words of 48-bit instructions (or 40-bit data), or combinations of different word sizes up to 4 megabits. A 16-bit floating-point storage format is supported which effectively doubles the amount of data that may be stored on chip. Conversion between the 32-bit floating point and 16-bit floating point formats is done in a single instruction. Each memory block is dual-ported for single-cycle, independent accesses by the core processor and I/O processor or DMA controller. The dual-ported memory and separate on-chip buses allow two data transfers from the core and one from I/O, all in a single cycle.

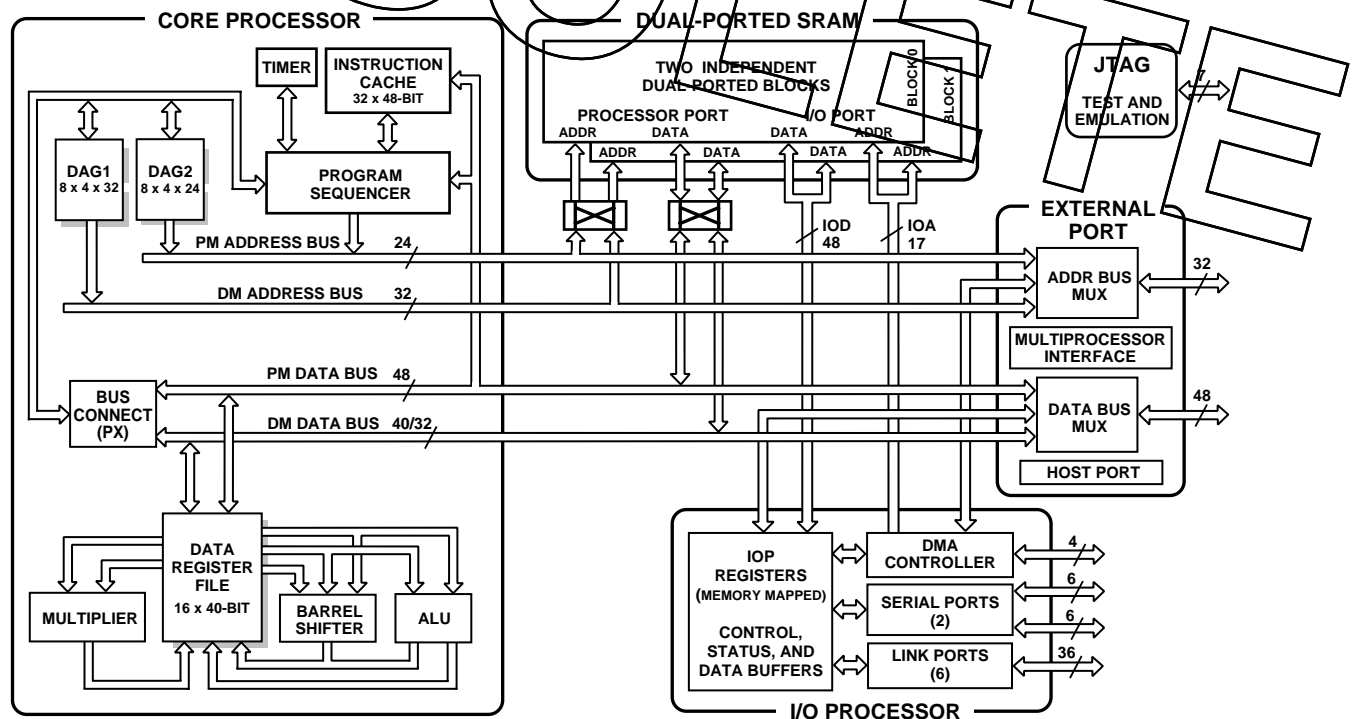

Figure 1. ADSP-21060 Processor Block Diagram (Core of the AD14160/AD14160L)

# AD14160/AD14160L

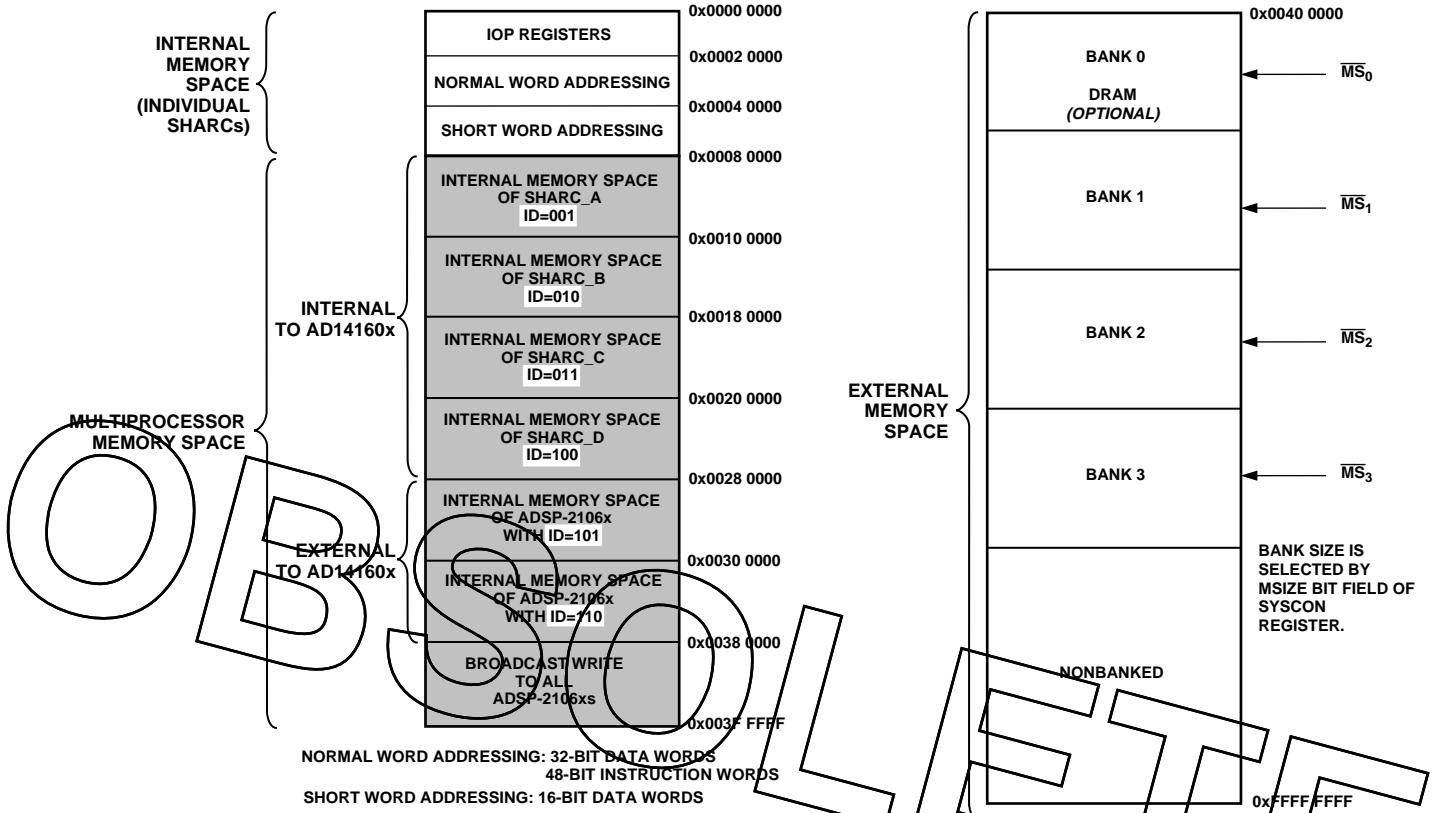

Figure 2. AD14160/AD14160L Memory Map

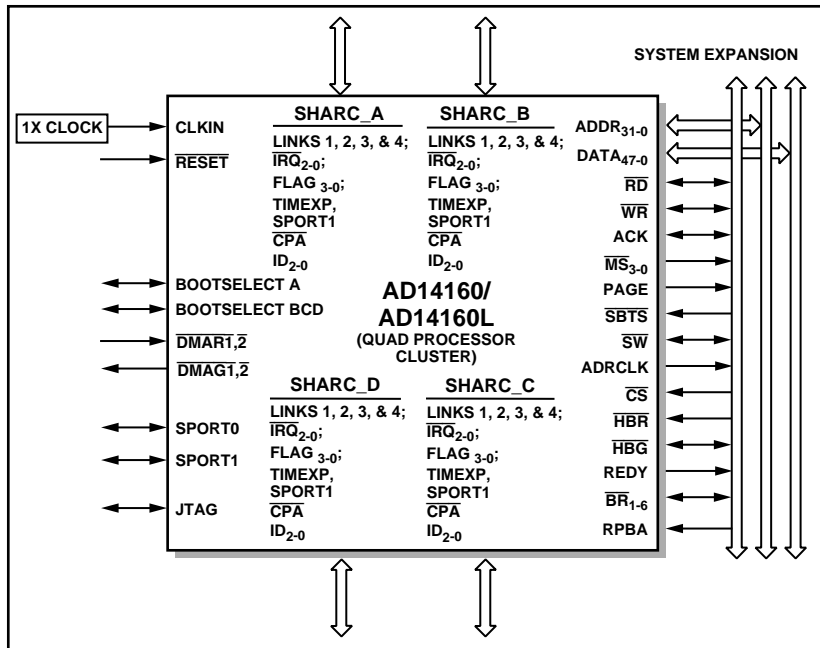

Figure 3. Complete Shared Memory Multiprocessing System

# AD14160/AD14160L

## Shared Memory Multiprocessing

The AD14160/AD14160L takes advantage of the powerful multiprocessing features built into the SHARC. The SHARCs are connected to maximize the performance of this cluster-of-four architecture, and still allow for off-module expansion. The AD14160/AD14160L in itself is a complete shared memory multiprocessing system, as shown in Figure 3. The unified address space of the SHARCs allows direct interprocessor accesses of each SHARC's internal memory. In other words, each SHARC can directly access the internal memory and IOP registers of each of the other SHARCs by simply reading or writing to the appropriate address in multi-processor memory space (see Figure 2)—this is called a *direct read* or *direct write*.

Bus arbitration is accomplished with the on-SHARC arbitration logic. Each SHARC has a unique ID, and drives the Bus-Request (BR) line corresponding to its ID, while monitoring all others. BR1–BR4 are used within the AD14160/AD14160L, while BR5 and BR6 can be used for expansion. All bus requests (BR1–BR6) are included in the module I/O.

Two different priority schemes, fixed and rotating, are available to resolve competing bus requests. The RPBA pin selects which scheme is used: when RPBA is high, rotating priority bus arbitration is selected, and when RPBA is low, fixed priority is selected.

**Table I. Rotating Priority Arbitration Example**

Cycle	Hardware Processor IDs						
	ID1	ID2	ID3	ID4	ID5	ID6	
1	M	1	2 BR	3	4	5	<i>Initial Priority Assignments</i>
2	4	5 BR	M-BR	1	2	3	
3	4	5 BR	M	1	2	3	
4	5 BR	M	1	2	3	4 BR	<i>Final Priority Assignments</i>
5	1 BR	2	3	4	5	M	

### NOTES

- 1–5 = Assigned Priority.
- M = Bus Mastership (in that cycle).
- BR = Requesting Bus Mastership with BRx.

Bus mastership is passed from one SHARC to another during a *bus transition cycle*. A bus transition cycle only occurs when the current bus master deasserts its BR line and one of the slave SHARCs asserts its BR line. The bus master can therefore retain bus mastership by keeping its BR line asserted. When the bus master deasserts its BR line, and no other BR line is asserted, then the master will not lose any bus cycles. When more than one SHARC asserts its BR line, the SHARC with the highest priority request becomes bus master on the following cycle. Each SHARC observes all of the BR lines, and therefore tracks when a bus transition cycle has occurred, and which processor has become the new bus master. Master processor changeover incurs only one cycle of overhead. An example bus transition sequence is shown in Table I.

Bus locking is possible, allowing indivisible read-modify-write sequences for semaphores. In either the fixed or rotating priority scheme, it is also possible to limit the number of cycles the master can control the bus. The AD14160/AD14160L also provides the option of using the Core Priority Access (CPA) mode of the SHARC. Using the CPA signal allows external bus accesses by the core processor of a slave SHARC to take priority over ongoing DMA transfers. Also, each SHARC can broadcast write to all other SHARCs simultaneously, allowing the implementation of reflective semaphores.

The bus master can communicate with slave SHARCs by writing messages to their internal IOP registers. The MSR0–MSRG7 registers are general-purpose registers that can be used for convenient message passing, semaphores and resource sharing between the SHARCs. For message passing, the master communicates with a slave by writing and/or reading any of the eight message registers on the slave. For vector interrupts, the master can issue a vector interrupt to a slave by writing the address of an interrupt service routine to the slave's VIRPT register. This causes an immediate high priority interrupt on the slave which, when serviced, will cause it to branch to the specified service routine.

## Off-Module Memory and Peripherals Interface

The AD14160/AD14160L's external port provides the interface to off-module memory and peripherals (see Figure 5). This port consists of the complete external port bus of the SHARC, bused together in common among the four SHARCs.

The 4-gigaword off-module address space is included in the AD14160/AD14160L's unified address space. Addressing of external memory devices is facilitated by each SHARC internally decoding the high order address lines to generate memory bank select signals. Separate control lines are also generated for simplified addressing of page-mode DRAM. The AD14160/AD14160L also supports programmable memory wait states and external memory acknowledge controls to allow interfacing to DRAM and peripherals with variable access, hold and disable time requirements.

## Link Port I/O

Each individual SHARC features six 4-bit link ports that facilitate SHARC-to-SHARC communication and external I/O interfacing. Each link port can be configured for either 1× or 2× operation, allowing each to transfer either 4 or 8 bits per cycle. The link ports can operate independently and simultaneously, with a maximum bandwidth of 40 MBytes/s each, or a total of 240 MBytes/s per SHARC.

The AD14160/AD14160L provides additional link port I/O beyond that of the AD14060. Internally, two links from each SHARC form a ring connection among the four. The remaining four link ports from each SHARC are brought out independently from each SHARC. A maximum of 640 MBytes/s link port bandwidth is then available off of the AD14160/AD14160L. The link port connections are detailed in Figure 4.

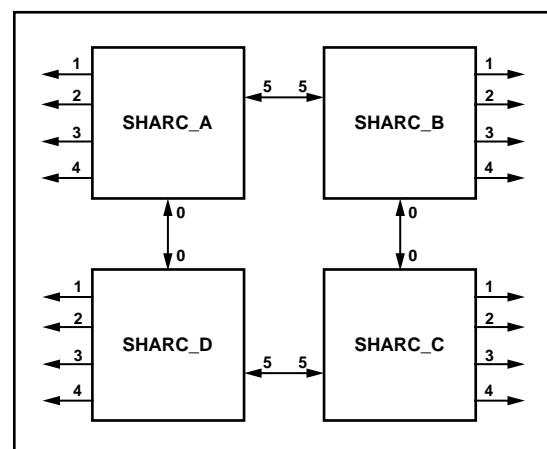

Figure 4. Link Port Connections

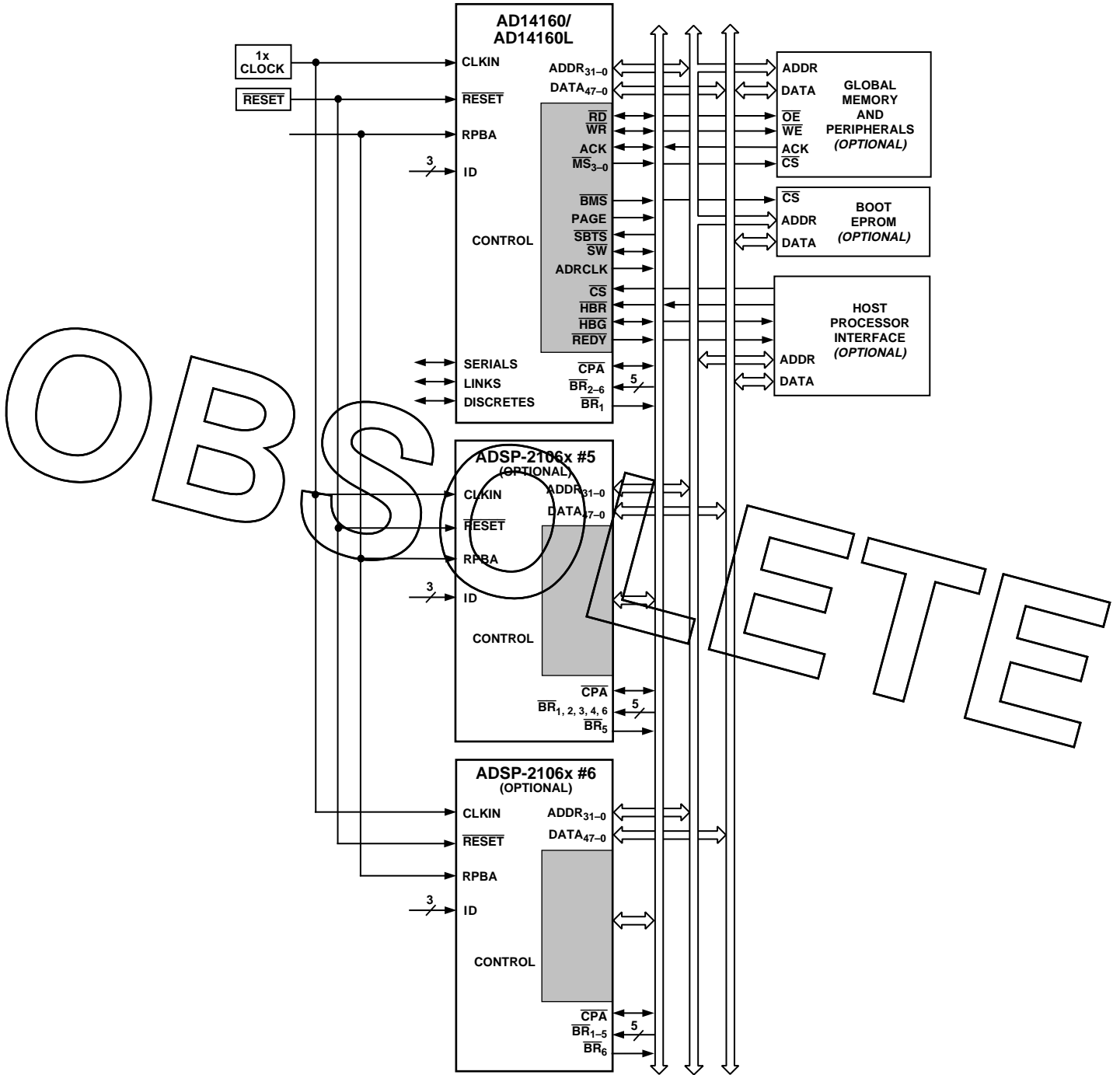

Figure 5. Optional System Interconnections

# AD14160/AD14160L

Link port 4, the boot link port, is brought off independently from each SHARC. Individual booting is then allowed, or chained link port booting is possible as described under “Link Port Booting.”

Link port data is packed into 32-bit or 48-bit words, and can be directly read by the SHARC core processor or DMA-transferred to on-SHARC memory.

Each link port has its own double-buffered input and output registers. Clock/acknowledge handshaking controls link port transfers. Transfers are programmable as either transmit or receive.

## Serial Ports

The SHARC serial ports provide an inexpensive interface to a wide variety of digital and mixed-signal peripheral devices. Each SHARC has two serial ports. All eight of the AD14160/AD14160L serial ports are brought off-module.

The serial ports can operate at the full clock rate of the module, providing each with a maximum data rate of 40 Mbit/s. Independent transmit and receive functions provide more flexible communications. Serial port data can be automatically transferred to and from on-SHARC memory via DMA, and each of the serial ports offers time division multiplexed (TDM) multi-channel mode.

The serial ports can operate with little-endian or big-endian transmission formats, with word lengths selectable from 3 bits to 32 bits. They offer selectable synchronization and transmit modes as well as optional  $\mu$ -law or A-law companding. Serial port clocks and frame syncs can be internally or externally generated.

## Program Booting

The AD14160/AD14160L supports automatic downloading of programs following power-up or a software reset. The SHARC offers four options for program booting: 1) from an 8-bit EPROM; 2) from a host processor; 3) through the link ports; and 4) no-boot. In no-boot mode, the SHARC starts executing instructions from address 0x0040 0004 in external memory. The boot mode is selected by the state of the following signals: BMS, EBOOT, and LBOOT.

On the AD14160/AD14160L, SHARC\_A's boot mode is separately controlled, while SHARCs B, C, and D are controlled as a group. With this flexibility, the AD14160/AD14160L can be configured to boot in any of the following methods.

### Multiprocessor Host Booting

To boot multiple ADSP-21060 processors from a host, each ADSP-21060 must have its EBOOT, LBOOT and BMS pins configured for host booting: EBOOT = 0, LBOOT = 0, and BMS = 1. After system power-up, each ADSP-21060 will be in the idle state and the  $\overline{\text{BR}}_x$  bus request lines will be deasserted. The host must assert the  $\overline{\text{HBR}}$  input and boot each ADSP-21060 by asserting its CS pin and downloading instructions.

### Multiprocessor EPROM Booting

There are two methods of booting the multiprocessor system from an EPROM.

**SHARC\_A Is Booted, Which Then Boots the Others.** The EBOOT pin on the SHARC\_A must be set high for EPROM booting. All other ADSP-21060s should be configured for host booting (EBOOT = 0, LBOOT = 0, and BMS = 1), which leaves them in the idle state at start-up and allows SHARC\_A

to become bus master and boot itself. Only the BMS pin of SHARC\_A is connected to the chip select of the EPROM. When SHARC\_A has finished booting, it can boot the remaining ADSP-21060s by writing to their external port DMA buffer 0 (EPB0) via multiprocessor memory space.

### All ADSP-21060s Boot in Turn From a Single EPROM.

The BMS signals from each ADSP-21060 may be wire-ORed together to drive the chip select pin of the EPROM. Each ADSP-21060 can boot in turn, according to its priority. When the last one has finished booting, it must inform the others (which may be in the idle state) that program execution can begin.

### Multiprocessor Link Port Booting

Booting can also be accomplished from a single source through the link ports. Link Buffer 4 must always be used for booting. To simultaneously boot all of the ADSP-21060s, a parallel common connection is available through Link Port 4 on each of the processors. Or, using the daisy chain connection that exists between the processors' link ports, each ADSP-21060 can boot the next one in turn. In this case, the Link Assignment Register (LAR) must be programmed to configure the internal link ports with Link Buffer 4.

### Multiprocessor Booting From External Memory

If external memory contains a program after reset, then SHARC\_A should be set up for *no boot* mode; it will begin executing from address 0x0040 0004 in external memory. When booting has completed, the other ADSP-21060s may be booted by SHARC\_A if they are set up for host booting, or they can begin executing out of external memory if they are set up for *no boot* mode. Multiprocessor bus arbitration will allow this booting to occur in an orderly manner.

### Host Processor Interface

The AD14160/AD14160L's host interface allows for easy connection to standard microprocessor buses, both 16-bit and 32-bit, with little additional hardware required. Asynchronous transfers at speeds up to the full clock rate of the module are supported. The host interface is accessed through the AD14160/AD14160L external port and is memory-mapped into the unified address space. Four channels of DMA are available for the host interface; code and data transfers are accomplished with low software overhead.

The host processor requests the AD14160/AD14160L's external bus with the host bus request ( $\overline{\text{HBR}}$ ), host bus grant ( $\overline{\text{HBG}}$ ), and ready (REDY) signals. The host can directly read and write the internal memory of the SHARCs, and can access the DMA channel setup and mailbox registers. Vector interrupt support is provided for efficient execution of host commands.

### Direct Memory Access (DMA) Controller

The SHARCs on-chip DMA control logic allows zero-overhead data transfers without processor intervention. The DMA controller operates independently and invisibly to each SHARC's processor core, allowing DMA operations to occur while the core is simultaneously executing its program instructions.

DMA transfers can occur between SHARC internal memory and either external memory, external peripherals, or a host processor. DMA transfers can also occur between the SHARC's internal memory and its serial ports or link ports. DMA transfers between external memory and external peripheral devices are another option. External bus packing to 16-, 32- or 48-bit words is performed during DMA transfers.

Ten channels of DMA are available on the SHARCs—two via the link ports, four via the serial ports, and four via the processor's external port (for either host processor, other SHARCs, memory, or I/O transfers). Four additional link port DMA channels are shared with serial port 1 and the external port. Programs can be downloaded to the SHARCs using DMA transfers. Asynchronous off-module peripherals can control two DMA channels using DMA Request/Grant lines (DMARI-2, DMAGI-2). Other DMA features include interrupt generation upon completion of DMA transfers and DMA chaining for automatic linked DMA transfers.

## Development Tools

The AD14160/AD14160L is supported with a complete set of software and hardware development tools, including an EZ-LAB<sup>®</sup> In-Circuit Emulator, and development software.

Analog Devices' ADSP-21000 Family Development Software includes an easy to use Assembler based on an algebraic syntax, an Assembly Library/Librarian, a Linker, an Instruction-Level Simulator, an ANSI C optimizing Compiler, the CBug<sup>™</sup> C Source-Level Debugger, and a C Runtime Library including DSP and mathematical functions. The Optimizing Compiler includes Numerical C extensions based on the work of the ANSI Numerical C Extensions Group. Numerical C provides extensions to the C language for array selection, vector math operations, complex data types, circular pointers and variably dimensioned arrays. The ADSP-21000 Family Development Software is available for both the PC and Sun platforms.

The SHARC EZ-KIT combines the ADSP-21000 Family Development Software for the PC and the EZ-LAB Development Board in one package.

The ADSP-2106x EZ-ICE<sup>®</sup> Emulator uses the IEEE 1149.1 JTAG test access port of the ADSP-2106x processor to monitor and control the target board processor during emulation. The

EZ-ICE provides full-speed emulation, allowing inspection and modification of memory, registers and processor stacks.

Nonintrusive in-circuit emulation is assured by the use of the processor's JTAG interface—the emulator does not affect target system loading or timing.

Further details and ordering information are available in the *ADSP-21000 Family Hardware & Software Development Tools* data sheet (ADDS-2100xx-TOOLS). This data sheet can be requested from any Analog Devices sales office or distributor, or from the Literature Center.

In addition to the software and hardware development tools available from Analog Devices, third parties provide a wide range of tools supporting the SHARC processor family. Hardware tools include SHARC PC plug-in cards, multiprocessor SHARC VME boards, and daughter card modules with multiple SHARCs and additional memory. These modules are based on the SHARCPAC<sup>™</sup> module specification. Third party software tools include an Ada compiler, DSP libraries, operating systems and block diagram design tools.

## Other Package Details

The AD14160/AD14160L contains 14 on-module 0.1 microfarad bypass capacitors. It is recommended that in the target system at least four additional capacitors, of 0.018 microfarad value, be placed around the module—one near each of the four corners.

The top surface, I<sub>td</sub>, of the AD14160/AD14160L is electrically connected to GND.

## Additional Information

This data sheet provides a general overview of the AD14160/AD14160L architecture and functionality. For detailed information on the ADSP-2106x SHARC and the ADSP-21000 Family core architecture and instruction set, refer to the *ADSP-2106x SHARC User's Manual*.

# AD14160/AD14160L

## PIN FUNCTION DESCRIPTIONS

AD14160/AD14160L pin definitions are listed below. Inputs identified as synchronous (S) must meet timing requirements with respect to CLKIN (or with respect to TCK for TMS, TDI). Inputs identified as asynchronous (A) can be asserted asynchronously to CLKIN (or to TCK for  $\overline{\text{TRST}}$ ).

Unused inputs should be tied or pulled to  $V_{DD}$  or GND, except for  $\text{ADDR}_{31-0}$ ,  $\text{DATA}_{47-0}$ ,  $\text{FLAG}_{2-0}$ ,  $\overline{\text{SW}}$ , and inputs that have internal pull-up or pull-down resistors (CPA, ACK, DTx, DRx,

TCLKx, RCLKx, LxDAT<sub>3-0</sub>, LxCLK, LxACK, TMS and TDI)—these pins can be left floating. These pins have a logic-level hold circuit that prevents the input from floating internally.

A = Asynchronous    O = Output    (A/D) = Active Drive  
 G = Ground    P = Power Supply    (O/D) = Open Drain  
 I = Input    S = Synchronous  
 T = Three-State (when  $\overline{\text{SBTS}}$  is asserted, or when the AD14160/AD14160L is a bus slave)

Pin	Type	Function
$\text{ADDR}_{31-0}$	I/O/T	<b>External Bus Address.</b> (Common to all SHARCs) The AD14160/AD14160L outputs addresses for external memory and peripherals on these pins. In a multiprocessor system, the bus master outputs addresses for read/writes on the internal memory or IOP registers of slave ADSP-2106xs. The AD14160/AD14160L inputs addresses when a host processor or multiprocessing bus master is reading or writing the internal memory or IOP registers of internal ADSP-21060s.
$\text{DATA}_{47-0}$	I/O/T	<b>External Bus Data.</b> (Common to all SHARCs) The AD14160/AD14160L inputs and outputs data and instructions on these pins. 32-bit single-precision floating-point data and 32-bit fixed-point data is transferred over bits 47-16 of the bus. 40-bit extended-precision floating-point data is transferred over bits 47-8 of the bus. 16-bit short word data is transferred over bits 31-16 of the bus. In PROM boot mode, 8-bit data is transferred over bits 23-16. Pull-up resistors on unused DATA pins are not necessary.
$\overline{\text{MS}}_{3-0}$	O/T	<b>Memory Select Lines.</b> (Common to all SHARCs) These lines are asserted (low) as chip selects for the corresponding banks of external memory. Memory bank size must be defined in the individual ADSP-21060's system control registers (SYSCON). The $\overline{\text{MS}}_{3-0}$ lines are decoded memory address lines that change at the same time as the other address lines. When no external memory access is occurring the $\overline{\text{MS}}_{3-0}$ lines are inactive; they are active, however, when a conditional memory access instruction is executed, whether or not the condition is true. $\overline{\text{MS}}_0$ can be used with the PAGE signal to implement a bank of DRAM memory (Bank 0). In a multiprocessing system, the $\overline{\text{MS}}_{3-0}$ lines are output by the bus master.
$\overline{\text{RD}}$	I/O/T	<b>Memory Read Strobe.</b> (Common to all SHARCs) This pin is asserted (low) when the AD14160/AD14160L reads from external devices or when the internal memory of internal ADSP-2106xs is being accessed. External devices (including other ADSP-2106xs) must assert $\overline{\text{RD}}$ to read from the AD14160/AD14160L's internal memory. In a multiprocessing system, $\overline{\text{RD}}$ is output by the bus master and is input by all other ADSP-2106xs.
$\overline{\text{WR}}$	I/O/T	<b>Memory Write Strobe.</b> (Common to all SHARCs) This pin is asserted (low) when the AD14160/AD14160L writes to external devices or when the internal memory of internal ADSP-2106xs is being accessed. External devices (including other ADSP-2106xs) must assert $\overline{\text{WR}}$ to write to the AD14160/AD14160L's internal memory. In a multiprocessing system $\overline{\text{WR}}$ is output by the bus master and is input by all other ADSP-2106xs.
PAGE	O/T	<b>DRAM Page Boundary.</b> (Common to all SHARCs) The AD14160/AD14160L asserts this pin to signal that an external DRAM page boundary has been crossed. DRAM page size must be defined in the individual ADSP-21060's memory control register (WAIT). DRAM can only be implemented in external memory Bank 0; the PAGE signal can only be activated for Bank 0 accesses. In a multiprocessing system, PAGE is output by the bus master.
ADRCLK	O/T	<b>Clock Output Reference.</b> (Common to all SHARCs) In a multiprocessing system, ADRCLK is output by the bus master.
$\overline{\text{SW}}$	I/O/T	<b>Synchronous Write Select.</b> (Common to all SHARCs) This signal is used to interface the AD14160/AD14160L to synchronous memory devices (including other ADSP-2106xs). The AD14160/AD14160L asserts $\overline{\text{SW}}$ (low) to provide an early indication of an impending write cycle, which can be aborted if $\overline{\text{WR}}$ is not later asserted (e.g., in a conditional write instruction). In a multiprocessing system, $\overline{\text{SW}}$ is output by the bus master and is input by all other ADSP-2106xs to determine if the multiprocessor memory access is a read or write. $\overline{\text{SW}}$ is asserted at the same time as the address output. A host processor using synchronous writes must assert this pin when writing to the AD14160/AD14160L.
ACK	I/O/S	<b>Memory Acknowledge.</b> (Common to all SHARCs) External devices can deassert ACK (low) to add wait states to an external memory access. ACK is used by I/O devices, memory controllers, or other peripherals to hold off completion of an external memory access. The AD14160/AD14160L deasserts ACK, as an output, to add wait states to a synchronous access of its internal memory. In a multiprocessing system, a slave ADSP-2106x deasserts the bus master's ACK input to add wait state(s) to an access of its internal memory. The bus master has a keeper latch on its ACK pin that maintains the input at the level it was last driven to.



Pin	Type	Function
$\overline{\text{SBTS}}$	I/S	<b>Suspend Bus Three-State.</b> (Common to all SHARCs) External devices can assert $\overline{\text{SBTS}}$ (low) to place the external bus address, data, selects, and strobes in a high impedance state for the following cycle. If the AD14160/AD14160L attempts to access external memory while $\overline{\text{SBTS}}$ is asserted, the processor will halt and the memory access will not be completed until $\overline{\text{SBTS}}$ is deasserted. $\overline{\text{SBTS}}$ should only be used to recover from host processor/AD14160/AD14160L deadlock, or used with a DRAM controller.
$\overline{\text{HBR}}$	I/A	<b>Host Bus Request.</b> (Common to all SHARCs) Must be asserted by a host processor to request control of the AD14160/AD14160L's external bus. When $\overline{\text{HBR}}$ is asserted in a multiprocessing system, the ADSP-2106x that is bus master will relinquish the bus and assert $\overline{\text{HBG}}$ . To relinquish the bus, the ADSP-2106x places the address, data, select, and strobe lines in a high impedance state. $\overline{\text{HBR}}$ has priority over all ADSP-2106x bus requests ( $\overline{\text{BR}}_{6-1}$ ) in a multiprocessing system.
$\overline{\text{HBG}}$	I/O	<b>Host Bus Grant.</b> (Common to all SHARCs) Acknowledges an $\overline{\text{HBR}}$ bus request, indicating that the host processor may take control of the external bus. $\overline{\text{HBG}}$ is asserted (held low) by the AD14160/AD14160L until $\overline{\text{HBR}}$ is released. In a multiprocessing system, $\overline{\text{HBG}}$ is output by the ADSP-2106x bus master and is monitored by all others.
$\overline{\text{CSA}}$	I/A	<b>Chip Select.</b> Asserted by host processor to select SHARC_A.
$\overline{\text{CSB}}$	I/A	<b>Chip Select.</b> Asserted by host processor to select SHARC_B.
$\overline{\text{CSC}}$	I/A	<b>Chip Select.</b> Asserted by host processor to select SHARC_C.
$\overline{\text{CSD}}$	I/A	<b>Chip Select.</b> Asserted by host processor to select SHARC_D.
REDY (O/D)	O	<b>Host Bus Acknowledge.</b> (Common to all SHARCs) The AD14160/AD14160L deasserts REDY (low) to add wait states to an asynchronous access of its internal memory or IOP registers by a host. Open drain output (O/D) by default; can be programmed in ADREDY bit of SYSCON register of individual ADSP-21060s to be active drive (A/D). REDY will only be output if the CS and $\overline{\text{HBR}}$ inputs are asserted.
$\overline{\text{BR}}_{6-1}$	I/O/S	<b>Multiprocessing Bus Requests.</b> (Common to all SHARCs) Used by multiprocessing ADSP-2106xs to arbitrate for bus mastership. An ADSP-2106x only drives its own $\overline{\text{BR}}_x$ line (corresponding to the value of its ID2-0 inputs) and monitors all others. In a multiprocessor system with less than six ADSP-2106xs, the unused $\overline{\text{BR}}_x$ pins should be pulled high; $\overline{\text{BR}}_{4-1}$ must not be pulled high or low because they are outputs.
IDy2-0	I	<b>Multiprocessing ID.</b> (Individual ID2-0 from y = SHARC_A, SHARC_B, SHARC_C, SHARC_D.) Determines which multiprocessing bus request ( $\overline{\text{BR}}_1$ - $\overline{\text{BR}}_6$ ) is used by individual ADSP-2106x's. ID = 001 corresponds to $\overline{\text{BR}}_1$ , ID = 010 corresponds to $\overline{\text{BR}}_2$ , etc. ID = 000 is reserved for single processor systems. These lines are a system configuration selection, which should be hardwired or only changed at reset.
RPBA	I/S	<b>Rotating Priority Bus Arbitration Select.</b> (Common to all SHARCs) When RPBA is high, rotating priority for multiprocessor bus arbitration is selected. When RPBA is low, fixed priority is selected. This signal is a system configuration selection that must be set to the same value on every ADSP-2106x. If the value of RPBA is changed during system operation, it must be changed in the same CLKIN cycle on every ADSP-2106x.
$\overline{\text{CPA}}_y$ (O/D)	I/O	<b>Core Priority Access.</b> (y = SHARC_A, B, C, D) Asserting its CPA pin allows the core processor of an ADSP-2106x bus slave to interrupt background DMA transfers and gain access to the external bus. CPA is an open drain output that is connected to all ADSP-2106x in the system if this function is required. The CPA pin of each internal ADSP-21060 is brought out individually. The CPA pin has an internal 5 k $\Omega$ pull-up resistor. If core access priority is not required in a system, the CPA pin should be left unconnected.
DTy0	O/T	<b>Data Transmit</b> (Serial Port 0 individual from SHARC_A, SHARC_B, SHARC_C, SHARC_D). DT pin has a 50 k $\Omega$ internal pull-up resistor.
DRy0	I	<b>Data Receive</b> (Serial Port 0 individual from SHARC_A, SHARC_B, SHARC_C, SHARC_D). DR pin has a 50 k $\Omega$ internal pull-up resistor.
TCLKy0	I/O	<b>Transmit Clock</b> (Serial Port 0 individual from SHARC_A, SHARC_B, SHARC_C, SHARC_D). TCLK pin has a 50 k $\Omega$ internal pull-up resistor.
RCLKy0	I/O	<b>Receive Clock</b> (Serial Port 0 individual from SHARC_A, SHARC_B, SHARC_C, SHARC_D). RCLK pin has a 50 k $\Omega$ internal pull-up resistor.
TFSy0	I/O	<b>Transmit Frame Sync</b> (Serial Port 0 individual from SHARC_A, SHARC_B, SHARC_C, SHARC_D).
RFSy0	I/O	<b>Receive Frame Sync</b> (Serial Port 0 individual from SHARC_A, SHARC_B, SHARC_C, SHARC_D).

# AD14160/AD14160L

Pin	Type	Function
DTy1	O/T	<b>Data Transmit</b> (Serial Port 1 individual from SHARC_A, SHARC_B, SHARC_C, SHARC_D) DT pin has a 50 kΩ internal pull-up resistor.
DRy1	I	<b>Data Receive</b> (Serial Port 1 individual from SHARC_A, SHARC_B, SHARC_C, SHARC_D) DR pin has a 50 kΩ internal pull-up resistor.
TCLKy1	I/O	<b>Transmit Clock</b> (Serial Port 1 individual from SHARC_A, SHARC_B, SHARC_C, SHARC_D) TCLK pin has a 50 kΩ internal pull-up resistor.
RCLKy1	I/O	<b>Receive Clock</b> (Serial Port 1 individual from SHARC_A, SHARC_B, SHARC_C, SHARC_D) RCLK pin has a 50 kΩ internal pull-up resistor.
TFSy1	I/O	<b>Transmit Frame Sync</b> (Serial Port 1 individual from SHARC_A, SHARC_B, SHARC_C, SHARC_D)
RFSy1	I/O	<b>Receive Frame Sync</b> (Serial Port 1 individual from SHARC_A, SHARC_B, SHARC_C, SHARC_D)
FLAGy3-0	I/O/A	<b>Flag Pins.</b> (Individual FLAG3-0 from y = SHARC_A, SHARC_B, SHARC_C, SHARC_D) Each is configured via control bits as either an input or output. As an input, it can be tested as a condition. As an output, it can be used to signal external peripherals.
IRQy2-0	I/A	<b>Interrupt Request Lines.</b> (Individual IRQ2-0 from y = SHARC_A, SHARC_B, SHARC_C, SHARC_D) May be either edge-triggered or level-sensitive.
DMAR1	I/A	<b>DMA Request 1</b> (DMA Channel 7). Common to SHARC_A, SHARC_B, SHARC_C, SHARC_D.
DMAR2	I/A	<b>DMA Request 2</b> (DMA Channel 8). Common to SHARC_A, SHARC_B, SHARC_C, SHARC_D.
DMAG1	O/T	<b>DMA Grant 1</b> (DMA Channel 7). Common to SHARC_A, SHARC_B, SHARC_C, SHARC_D.
DMAG2	O/T	<b>DMA Grant 2</b> (DMA Channel 8). Common to SHARC_A, SHARC_B, SHARC_C, SHARC_D.
LyxCLK	I/O	<b>Link Port Clock</b> (y = SHARC_A, B, C, D; x = Link Ports 1, 2, 3, 4) <sup>1</sup> . Each LyxCLK pin has a 50 kΩ internal pull-down resistor which is enabled or disabled by the LPDRD bit of the LCOM register, of the ADSP-21060.
LyxDAT3-0	I/O	<b>Link Port Data</b> (y = SHARC_A, B, C, D; x = Link Ports 1, 2, 3, 4) <sup>1</sup> . Each LyxDAT pin has a 50 kΩ internal pull-down resistor which is enabled or disabled by the LPDRD bit of the LCOM register, of the ADSP-21060.
LyxACK	I/O	<b>Link Port Acknowledge</b> (y = SHARC_A, B, C, D; x = Link Ports 1, 2, 3, 4) <sup>1</sup> . Each LyxACK pin has a 50 kΩ internal pull-down resistor which is enabled or disabled by the LPDRD bit of the LCOM register, of the ADSP-21060.
EBOOTA	I	<b>EPROM Boot Select.</b> (SHARC_A) When EBOOTA is high, SHARC_A is configured for booting from an 8-bit EPROM. When EBOOTA is low, the LBOOTA and $\overline{\text{BMSA}}$ inputs determine booting mode for SHARC_A. See the following table. This signal is a system configuration selection which should be hardwired.
LBOOTA	I	<b>Link Boot.</b> When LBOOTA is high, SHARC_A is configured for link port booting. When LBOOTA is low, SHARC_A is configured for host processor booting or no booting. See the following table. This signal is a system configuration selection which should be hardwired.
$\overline{\text{BMSA}}$	I/O/T <sup>2</sup>	<b>Boot Memory Select.</b> <i>Output:</i> Used as chip select for boot EPROM devices (when EBOOTA = 1, LBOOTA = 0). In a multiprocessor system, BMS is output by the bus master. <i>Input:</i> When low, indicates that no booting will occur and that SHARC_A will begin executing instructions from external memory. See the following table. This input is a system configuration selection which should be hardwired.
EBOOTBCD	I	<b>EPROM Boot Select.</b> (Common to SHARC_B, SHARC_C, SHARC_D) When EBOOTBCD is high, SHARC_B, C, D are configured for booting from an 8-bit EPROM. When EBOOTBCD is low, the LBOOTBCD and BMSBCD inputs determine booting mode for SHARC_B, C and D. See the following table. This signal is a system configuration selection which should be hardwired.
LBOOTBCD	I	<b>LINK Boot.</b> (Common to SHARC_B, SHARC_C, SHARC_D) When LBOOTBCD is high, SHARC_B, C, D are configured for link port booting. When LBOOTBCD is low, SHARC_B, C, D are configured for host processor booting or no booting. See the following table. This signal is a system configuration selection which should be hardwired.

Pin	Type	Function																												
$\overline{\text{BMSBCD}}$	I/O/T <sup>2</sup>	<p><b>Boot Memory Select.</b> <i>Output:</i> Used as chip select for boot EPROM devices (when EBOOTBCD = 1, LBOOTBCD = 0). In a multiprocessor system, BMS is output by the bus master. <i>Input:</i> When low, indicates that no booting will occur and that SHARC_B, C, D will begin executing instructions from external memory. See table below. This input is a system configuration selection which should be hardwired.</p> <table border="1"> <thead> <tr> <th>EBOOT</th> <th>LBOOT</th> <th><math>\overline{\text{BMS}}</math></th> <th>Booting Mode</th> </tr> </thead> <tbody> <tr> <td>1</td> <td>0</td> <td>Output</td> <td>EPROM (Connect BMS to EPROM chip select)</td> </tr> <tr> <td>0</td> <td>0</td> <td>1 (Input)</td> <td>Host Processor</td> </tr> <tr> <td>0</td> <td>1</td> <td>1 (Input)</td> <td>Link Port</td> </tr> <tr> <td>0</td> <td>0</td> <td>0 (Input)</td> <td>No Booting. Processor executes from external memory.</td> </tr> <tr> <td>0</td> <td>1</td> <td>0 (Input)</td> <td>Reserved</td> </tr> <tr> <td>1</td> <td>1</td> <td>x (Input)</td> <td>Reserved</td> </tr> </tbody> </table>	EBOOT	LBOOT	$\overline{\text{BMS}}$	Booting Mode	1	0	Output	EPROM (Connect BMS to EPROM chip select)	0	0	1 (Input)	Host Processor	0	1	1 (Input)	Link Port	0	0	0 (Input)	No Booting. Processor executes from external memory.	0	1	0 (Input)	Reserved	1	1	x (Input)	Reserved
EBOOT	LBOOT	$\overline{\text{BMS}}$	Booting Mode																											
1	0	Output	EPROM (Connect BMS to EPROM chip select)																											
0	0	1 (Input)	Host Processor																											
0	1	1 (Input)	Link Port																											
0	0	0 (Input)	No Booting. Processor executes from external memory.																											
0	1	0 (Input)	Reserved																											
1	1	x (Input)	Reserved																											
$\overline{\text{TIMEXP}}_y$	O	<b>Timer Expired.</b> (Individual TIMEXP from y = SHARC_A, SHARC_B, SHARC_C, SHARC_D) Asserted for four cycles when the timer is enabled and TCOUNT decrements to zero.																												
CLKIN	I	<b>Clock In.</b> (Common to all SHARCs) External clock input to the AD14160/AD14160L. The instruction cycle rate is equal to CLKIN. CLKIN may not be halted, changed, or operated below the minimum specified frequency.																												
$\overline{\text{RESET}}$	I/A	<b>Module Reset.</b> (Common to all SHARCs) Resets the AD14160/AD14160L to a known state. This input must be asserted (low) at power-up.																												
TCK	I	<b>Test Clock (JTAG).</b> (Common to all SHARCs) Provides an asynchronous clock for JTAG boundary scan.																												
TMS	I/S	<b>Test Mode Select (JTAG).</b> (Common to all SHARCs) Used to control the test state machine. TMS has a 20 k $\Omega$ internal pull-up resistor.																												
TDI	I/S	<b>Test Data Input (JTAG).</b> Provides serial data for the boundary scan logic chain starting at SHARC_A. TDI has a 20 k $\Omega$ internal pull-up resistor.																												
TDO	O	<b>Test Data Output (JTAG).</b> Serial scan output of the boundary scan chain path, from SHARC_D.																												
$\overline{\text{TRST}}$	I/A	<b>Test Reset (JTAG).</b> (Common to all SHARCs) Resets the test state machine. $\overline{\text{TRST}}$ must be asserted (pulsed low) after power-up or held low for proper operation of the AD14160/AD14160L. $\overline{\text{TRST}}$ has a 20 k $\Omega$ internal pull-up resistor.																												
$\overline{\text{EMU}}$ (O/D)	O	<b>Emulation Status.</b> (Common to all SHARCs) Must be connected to the ADSP-2106x EZ-ICE target board connector <i>only</i> .																												
V <sub>DD</sub>	P	<b>Power Supply.</b> Nominally +5.0 V dc for 5 V devices or +3.3 V dc for 3.3 V devices (50 pins).																												
GND	G	<b>Power Supply Return.</b> (64 pins).																												

NOTES

<sup>1</sup>LINK PORTS 0 and 5 are connected internally as described earlier in Link Port I/O.

<sup>2</sup>Three-statable only in EPROM boot mode (when  $\overline{\text{BMS}}$  is an output).

# AD14160/AD14160L

## TARGET BOARD CONNECTOR FOR EZ-ICE PROBE

The ADSP-2106x EZ-ICE Emulator uses the IEEE 1149.1 JTAG test access port of the ADSP-2106x to monitor and control the target board processor during emulation. The EZ-ICE probe requires that the AD14160/AD14160L's CLKIN (optional), TMS, TCK, TRST, TDI, TDO, EMU and GND signals be made accessible on the target system via a 14-pin connector (a pin strip header) such as that shown in Figure 6. The EZ-ICE probe plugs directly onto this connector for chip-on-board emulation. You must add this connector to your target board design if you intend to use the ADSP-2106x EZ-ICE. The length of the traces between the connector and the AD14160/AD14160L's JTAG pins should be as short as possible.

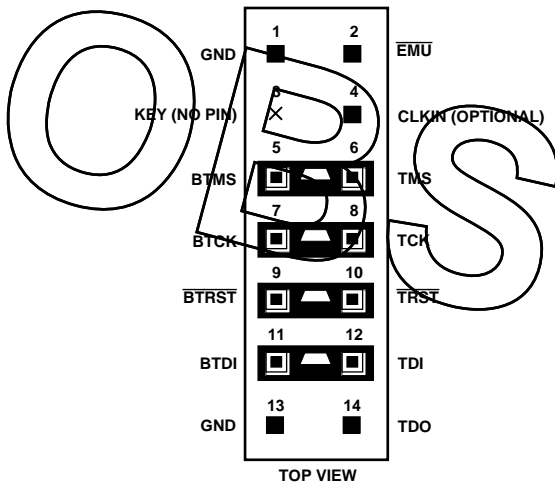

Figure 6. Target Board Connector for ADSP-2106x EZ-ICE Emulator (Jumpers in Place)

The 14-pin, 2-row pin strip header is keyed at the Pin 3 location; Pin 3 must be removed from the header. The pins must be 0.025 inch square and at least 0.20 inch in length. Pin spacing should be 0.1 x 0.1 inches. Pin strip headers are available from vendors such as 3M, McKenzie and Samtec.

The BTMS, BTCK, BTRST and BTDI signals are provided so that the test access port can also be used for board-level testing. When the connector is not being used for emulation, place jumpers between the Bxxx pins and the xxx pins as shown in Figure 6. If you are not going to use the test access port for board testing, tie BTRST to GND and tie or pull up BTCK to V<sub>DD</sub>. The TRST pin must be asserted after power-up (through BTRST on the connector) or held low for proper operation of the AD14160/AD14160L. None of the Bxxx pins (Pins 5, 7, 9, 11) are connected on the EZ-ICE probe.

The JTAG signals are terminated on the EZ-ICE probe as follows:

Signal	Termination
TMS	Driven through 22 Ω Resistor (16 mA/3.2 mA Driver)
TCK	Driven at 10 MHz through 22 Ω Resistor (16 mA/3.2 mA Driver)
TRST	Driven by Open Drain Driver* (Pulled Up by On-Chip 20 kΩ Resistor)
TDI	Driven by 16 mA/3.2 mA Driver
TDO	One TTL Load, No Termination
CLKIN	One TTL Load, No Termination (Optional Signal)
EMU	4.7 kΩ PullUp Resistor, One TTL Load (Open-Drain Output from ADSP-2106x)

\*TRST is driven low until the EZ-ICE probe is turned on by the EZ-ICE software (after the invocation command).

Figure 7 shows JTAG scan path connections for the multi-processor system.

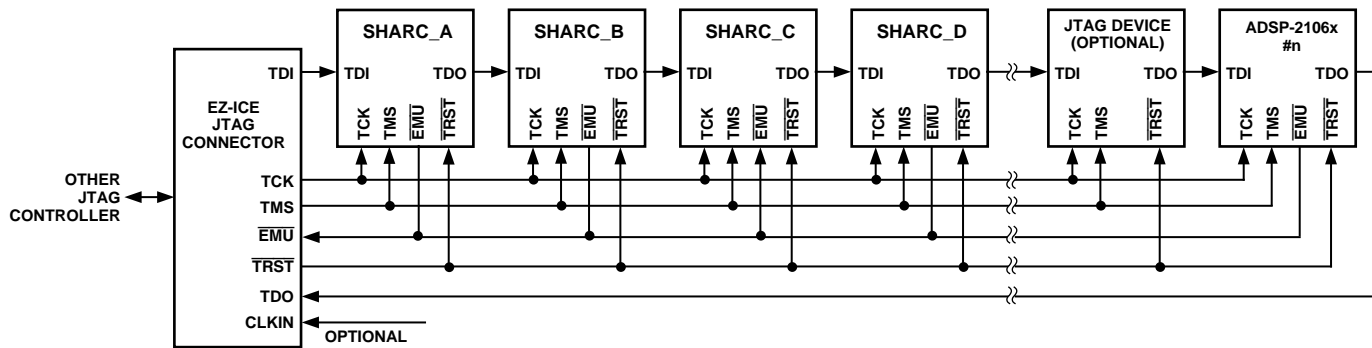

Figure 7. JTAG Scan Path Connections for the AD14160/AD14160L

Connecting CLKIN to Pin 4 of the EZ-ICE header is optional. The emulator only uses CLKIN when directed to perform operations such as starting, stopping and single-stepping multiple ADSP-2106xs in a synchronous manner. If you do not need these operations to occur synchronously on the multiple processors, simply tie Pin 4 of the EZ-ICE header to ground.

If synchronous multiprocessor operations are needed and CLKIN is connected, clock skew between the AD14160/AD14160L and the CLKIN pin on the EZ-ICE header must be minimal. If the skew is too large, synchronous operations may be off by one cycle between processors. For synchronous multiprocessor operation TCK, TMS, CLKIN and EMU should be

treated as critical signals in terms of skew, and should be laid out as short as possible on your board. If TCK, TMS and CLKIN are driving a large number of ADSP-2106xs (more than eight) in your system, then treat them as a “clock tree” using multiple drivers to minimize skew. (See Figure 8 JTAG Clock Tree and Clock Distribution in the “High Frequency Design Considerations” section of the *ADSP-2106x User’s Manual*).

If synchronous multiprocessor operations are not needed (i.e., CLKIN is not connected), just use appropriate parallel termination on TCK and TMS. TDI, TDO, EMU and TRST are not critical signals in terms of skew.

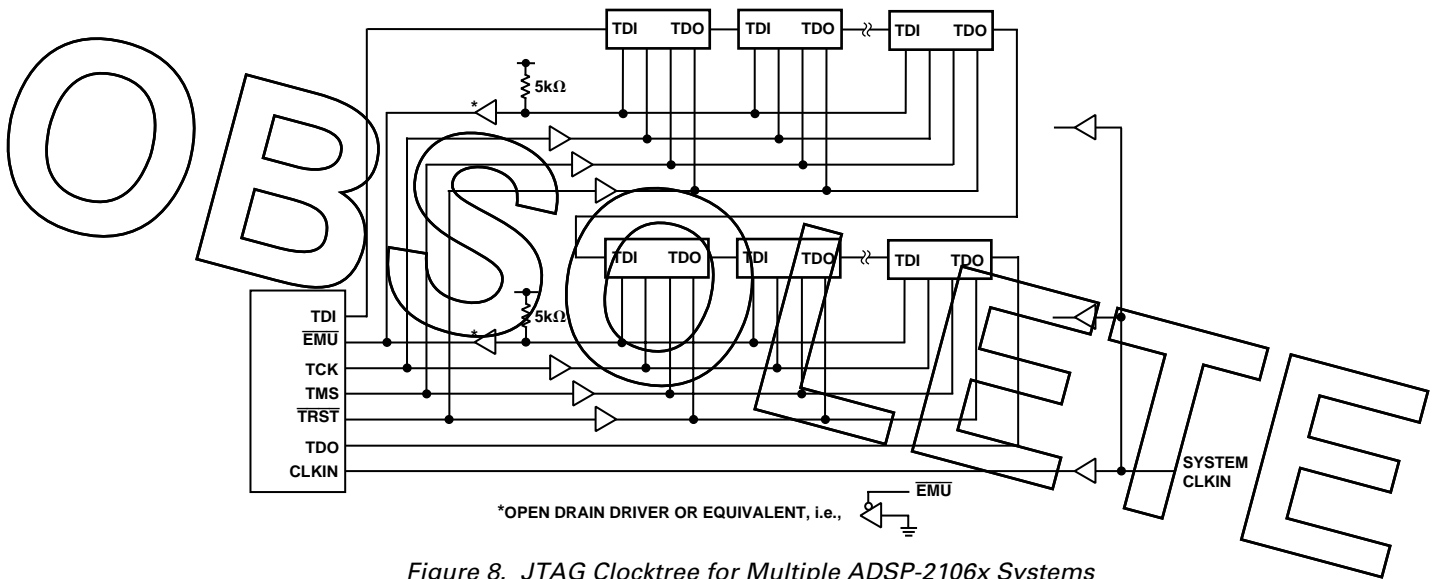

Figure 8. JTAG Clocktree for Multiple ADSP-2106x Systems

# AD14160/AD14160L—SPECIFICATIONS

## RECOMMENDED OPERATING CONDITIONS

Parameter		B Grade		K Grade		Units
		Min	Max	Min	Max	
V <sub>DD</sub>	Supply Voltage (5 V)	4.75	5.25	4.75	5.25	V
	Supply Voltage (3.3 V)	3.15	3.6	3.15	3.6	V
T <sub>CASE</sub>	Case Operating Temperature	-40	+100	0	+85	°C

## ELECTRICAL CHARACTERISTICS (5 V, 3.3 V SUPPLY)

Parameter	Case Temp	Test Level	Test Condition	5 V		3.3 V		Units
				Min	Typ Max	Min	Typ Max	
V <sub>IHI</sub>	High Level Input Voltage <sup>1</sup>	Full	I @ V <sub>DD</sub> = max	2.0	V <sub>DD</sub> + 0.5	2.0	V <sub>DD</sub> + 0.5	V
V <sub>IHI2</sub>	High Level Input Voltage <sup>2</sup>	Full	I @ V <sub>DD</sub> = max	2.2	V <sub>DD</sub> + 0.5	2.2	V <sub>DD</sub> + 0.5	V
V <sub>IL</sub>	Low Level Input Voltage <sup>1,2</sup>	Full	I @ V <sub>DD</sub> = min		0.8		0.8	V
V <sub>OH</sub>	High Level Output Voltage <sup>3,4</sup>	Full	I @ V <sub>DD</sub> = min, I <sub>OH</sub> = -2.0 mA <sup>4</sup>	4.1		2.4		V
V <sub>OL</sub>	Low Level Output Voltage <sup>3,4</sup>	Full	I @ V <sub>DD</sub> = min, I <sub>OL</sub> = 4.0 mA <sup>4</sup>		0.4		0.4	V
I <sub>IH</sub>	High Level Input Current <sup>5,6</sup>	Full	I @ V <sub>DD</sub> = max, V <sub>IN</sub> = V <sub>DD</sub> max		10		10	μA
I <sub>IHX4</sub>	High Level Input Current <sup>7,8</sup>	Full	I @ V <sub>DD</sub> = max, V <sub>IN</sub> = V <sub>DD</sub> max		40		40	μA
I <sub>IL</sub>	Low Level Input Current <sup>9</sup>	Full	I @ V <sub>DD</sub> = max, V <sub>IN</sub> = 0 V		10		10	μA
I <sub>ILX4</sub>	Low Level Input Current <sup>9</sup>	Full	I @ V <sub>DD</sub> = max, V <sub>IN</sub> = 0 V		40		40	μA
I <sub>ILP</sub>	Low Level Input Current <sup>9</sup>	Full	I @ V <sub>DD</sub> = max, V <sub>IN</sub> = 0 V		150		150	μA
I <sub>ILPX4</sub>	Low Level Input Current <sup>9</sup>	Full	I @ V <sub>DD</sub> = max, V <sub>IN</sub> = 0 V		600		600	μA
I <sub>OZH</sub>	Three-State Leakage Current <sup>9,10,11</sup>	Full	I @ V <sub>DD</sub> = max, V <sub>IN</sub> = V <sub>DD</sub> max		10		10	μA
I <sub>OZHx4</sub>	Three-State Leakage Current <sup>12</sup>	Full	I @ V <sub>DD</sub> = max, V <sub>IN</sub> = V <sub>DD</sub> max		40		40	μA
I <sub>OZL</sub>	Three-State Leakage Current <sup>9,13</sup>	Full	I @ V <sub>DD</sub> = max, V <sub>IN</sub> = 0 V		10		10	μA
I <sub>OZLx4</sub>	Three-State Leakage Current <sup>12</sup>	Full	I @ V <sub>DD</sub> = max, V <sub>IN</sub> = 0 V		40		40	μA
I <sub>OZHP</sub>	Three-State Leakage Current <sup>13</sup>	Full	I @ V <sub>DD</sub> = max, V <sub>IN</sub> = V <sub>DD</sub> max		350		350	μA
I <sub>OZLC</sub>	Three-State Leakage Current <sup>14</sup>	Full	I @ V <sub>DD</sub> = max, V <sub>IN</sub> = 0 V		1.5		1.5	mA
I <sub>OZLAR</sub>	Three-State Leakage Current <sup>11</sup>	Full	I @ V <sub>DD</sub> = max, V <sub>IN</sub> = 0 V		4.2		4.2	mA
I <sub>OZLA</sub>	Three-State Leakage Current <sup>15</sup>	Full	I @ V <sub>DD</sub> = max, V <sub>IN</sub> = 2 V (3.3 V), 1.5 V (5 V)		350		350	μA
I <sub>OZLS</sub>	Three-State Leakage Current <sup>10</sup>	Full	I @ V <sub>DD</sub> = max, V <sub>IN</sub> = 0 V		150		150	μA
I <sub>DDIN</sub>	Supply Current (Internal) <sup>16</sup>	Full	IV t <sub>CK</sub> = 25 ns, V <sub>DD</sub> = max	1.4	3.4	1	2.2	A
I <sub>DDIDLE</sub>	Supply Current (Idle) <sup>17</sup>	Full	I V <sub>DD</sub> = max		800		760	mA
C <sub>IN</sub>	Input Capacitance <sup>18,19</sup>	+25°C	V	15		15		pF

### EXPLANATION OF TEST LEVELS

#### Test Level

- I 100% Production Tested<sup>20</sup>.
- II 100% Production Tested at +25°C, and Sample Tested at Specified Temperatures.
- III Sample Tested Only.
- IV Parameter is guaranteed by design and analysis, and characterization testing on discrete SHARCs.
- V Parameter is typical value only.
- VI All devices are 100% production tested at +25°C; sample tested at temperature extremes.

#### NOTES

<sup>1</sup> Applies to input and bidirectional pins: DATA<sub>47-0</sub>, ADDR<sub>31-0</sub>,  $\overline{RD}$ ,  $\overline{WR}$ ,  $\overline{SW}$ , ACK,  $\overline{SBTS}$ ,  $\overline{IRQy0-3}$ , FLAGy0-3,  $\overline{HBG}$ ,  $\overline{CSy}$ ,  $\overline{DMAR1}$ ,  $\overline{DMAR2}$ ,  $\overline{BR}_{6-1}$ , IDy0-2, RPBA, CPAY, TFSy0, TFSy1, RFSy0, RFSy1, LyxDAT<sub>3-0</sub>, LyxCLK, LyxACK, EBOOTA, LBOOTA, EBOOTBCD, LBOOTBCD, BMSA, BMSBCD, TMS, TDI, TCK,  $\overline{HBR}$ , DRy0, DRy1, TCLKy0, TCLKy1, RCLKy0, RCLKy1.

<sup>2</sup> Applies to input pins: CLKIN,  $\overline{RESET}$ ,  $\overline{TRST}$ .

<sup>3</sup> Applies to output and bidirectional pins: DATA<sub>47-0</sub>, ADDR<sub>31-0</sub>,  $\overline{MS}_{3-0}$ ,  $\overline{RD}$ ,  $\overline{WR}$ , PAGE, ADRCLK,  $\overline{SW}$ , ACK, FLAGy0-3, TIMEXPy,  $\overline{HBG}$ , REDY,  $\overline{DMAG1}$ ,  $\overline{DMAG2}$ ,  $\overline{BR}_{6-1}$ , CPAY, DTy0, DTy1, TCLKy0, TCLKy1, RCLKy0, RCLKy1, TFSy0, TFSy1, RFSy0, RFSy1, LyxDAT<sub>3-0</sub>, LyxCLK, LyxACK, BMSA, BMSBCD, TDO, EMU.

<sup>4</sup> See Output Drive Currents for typical drive current capabilities.

<sup>5</sup> Applies to input pins:  $\overline{IRQy0-3}$ ,  $\overline{CSy}$ , IDy0-2, EBOOTA, LBOOTA.

<sup>6</sup> Applies to input pins with internal pull-ups: DRy0, DRy1, TDI.

<sup>7</sup> Applies to bussed input pins:  $\overline{SBTS}$ ,  $\overline{HBR}$ ,  $\overline{DMAR1}$ ,  $\overline{DMAR2}$ , RPBA, EBOOTBCD, LBOOTBCD, CLKIN,  $\overline{RESET}$ , TCK.

<sup>8</sup> Applies to bussed input pins with internal pull-ups:  $\overline{TRST}$ , TMS.

<sup>9</sup> Applies to three-statable pins: FLAGy0-3, BMSA, TDO.

<sup>10</sup> Applies to three-statable pins with internal pull-ups: DTy0, TCLKy0, RCLKy0, DTy1, TCLKy1, RCLKy1.

<sup>11</sup> Applies to ACK pin when pulled up. (Note that ACK is pulled up internally with 2 kΩ during reset in a multiprocessor system, when ID<sub>2-0</sub> = 001 and another ADSP-2106x is not requesting bus mastership.)

<sup>12</sup> Applies to bussed three-statable pins: DATA<sub>47-0</sub>, ADDR<sub>31-0</sub>,  $\overline{MS}_{3-0}$ ,  $\overline{RD}$ ,  $\overline{WR}$ , PAGE, ADRCLK,  $\overline{SW}$ , ACK, REDY,  $\overline{HBG}$ ,  $\overline{DMAG1}$ ,  $\overline{DMAG2}$ ,  $\overline{BMSBCD}$ , EMU. (Note that ACK is pulled up internally with 2 kΩ during reset in a multiprocessor system, when ID<sub>2-0</sub> = 001 and another ADSP-2106x is not requesting bus mastership.  $\overline{HBG}$  and EMU are not tested for leakage current.)

<sup>13</sup>Applies to three-statable pins with internal pull-downs: LyxDAT<sub>3-0</sub>, LyxCLK, LyxACK.

<sup>14</sup>Applies to  $\overline{\text{CPAy}}$  pin.

<sup>15</sup>Applies to ACK pin when keeper latch enabled.

<sup>16</sup>Applies to V<sub>DD</sub> pins. Conditions of operation: each processor executing radix-2 FFT butterfly with instruction in cache, one data operand fetched from each internal memory block, and one DMA transfer occurring from/to internal memory at t<sub>CK</sub> = 25 ns.

<sup>17</sup>Applies to V<sub>DD</sub> pins. Idle denotes AD14160/AD14160L state during execution of IDLE instruction.

<sup>18</sup>Applies to all signal pins.

<sup>19</sup>Guaranteed but not tested.

<sup>20</sup>Link and Serial Ports: All are 100% tested at die level prior to assembly. All are 100% ac tested at module level; Link-4 and Serial-0 are also dc tested at the module level. See Timing Specifications.

Specifications subject to change without notice.

## ABSOLUTE MAXIMUM RATINGS\*

Supply Voltage (5 V)	-0.3 V to +7 V
Supply Voltage (3.3 V)	-0.3 V to +4.6 V
Input Voltage	-0.5 V to V <sub>DD</sub> + 0.5 V
Output Voltage Swing	-0.5 V to V <sub>DD</sub> + 0.5 V
Load Capacitance	200 pF
Junction Temperature Under Bias	130°C
Storage Temperature Range	-65°C to +150°C
Solder Ball Temperature (5 seconds)	+230°C

\*Stresses greater than those listed above may cause permanent damage to the device. These are stress ratings only; functional operation of the device at these or any other conditions greater than those indicated in the operational sections of this specification is not implied. Exposure to absolute maximum rating conditions for extended periods may affect device reliability.

## ESD SENSITIVITY

The AD14160/AD14160L modules are ESD (electrostatic discharge) sensitive devices. Electrostatic charges readily accumulate on the human body and equipment and can discharge without detection. Permanent damage may occur to devices subjected to high energy electrostatic discharges.

The ADSP-21060 processors include proprietary ESD protection circuitry to dissipate high energy discharges. Per method 3015 of MIL-STD-883, the ADSP-21060 processors have been classified as a Class 2 device.

Proper ESD precautions are recommended to avoid performance degradation or loss of functionality. Unused devices must be stored in conductive foam or shunts, and the foam should be discharged to the destination socket before devices are removed.



## TIMING SPECIFICATIONS

### GENERAL NOTES

This data sheet represents production released specifications for the AD14160L (3.3 V), and the AD14160 (5 V). The ADSP-21060 die components are 100% tested, and the assembled AD14160/AD14160L units are again extensively tested at-speed, and across-temperature. Parametric limits were established from the ADSP-21060 characterization followed by further design/analysis of the AD14160/AD14160L package characteristics. The specifications shown are based on a CLKIN frequency of 40 MHz (t<sub>CK</sub> = 25 ns). The DT derating allows specifications at other CLKIN frequencies (within the min-max range of the t<sub>CK</sub> specification; see “Clock Input” below). DT is the difference between the actual CLKIN period and a CLKIN period of 25 ns:

$$DT = t_{CK} - 25 \text{ ns}$$

Use the exact timing information given. Do not attempt to derive parameters from the addition or subtraction of others.

While addition or subtraction would yield meaningful results for an individual device, the values given in this data sheet reflect statistical variations and worst cases. Consequently, you cannot meaningfully add parameters to derive longer times.

*Switching Characteristics* specify how the processor changes its signals. You have no control over this timing—circuitry external to the processor must be designed for compatibility with these signal characteristics. Switching characteristics tell you what the processor will do in a given circumstance. You can also use switching characteristics to ensure that any timing requirement of a device connected to the processor (such as memory) is satisfied.

*Timing Requirements* apply to signals that are controlled by circuitry external to the processor, such as the data input for a read operation. Timing requirements guarantee that the processor operates correctly with other devices.

(O/D) = Open Drain  
(A/D) = Active Drain

# AD14160/AD14160L

Parameter	40 MHz–5 V		40 MHz–3.3 V		Units
	Min	Max	Min	Max	
<b>Clock Input</b>					
<i>Timing Requirements:</i>					
$t_{CK}$	CLKIN Period		25	100	ns
$t_{CKL}$	CLKIN Width Low		7	8.75	ns
$t_{CKH}$	CLKIN Width High		5	5	ns
$t_{CKRF}$	CLKIN Rise/Fall (0.4 V–2.0 V)			3	ns

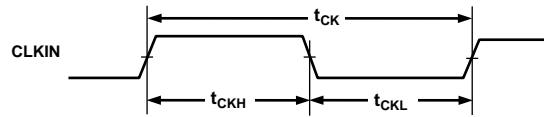

Figure 9. Clock Input

Parameter	40 MHz–5 V		40 MHz–3.3 V		Units
	Min	Max	Min	Max	
<b>Reset</b>					
<i>Timing Requirements:</i>					
$t_{WRST}$	RESET Pulsewidth Low <sup>1</sup>		$4t_{CK}$	$4t_{CK}$	ns
$t_{SRST}$	RESET Setup Before CLKIN High <sup>2</sup>		$14.5 + DT/2$	$14.5 + DT/2$	ns

**NOTES**

<sup>1</sup>Applies after the power-up sequence is complete. At power-up, the processor's internal phase-locked loop requires no more than 2000 CLKIN cycles while RESET is low, assuming stable  $V_{DD}$  and CLKIN (not including start-up time of external clock oscillator).

<sup>2</sup>Only required if multiple ADSP-2106xs must come out of reset synchronous to CLKIN with program counters (PC) equal (i.e., for a SIMD system). Not required for multiple ADSP-2106xs communicating over the shared bus (through the external port), because the bus arbitration logic automatically synchronizes itself after reset.

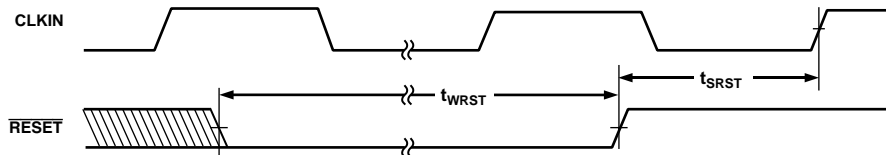

Figure 10. Reset

Parameter	40 MHz–5 V		40 MHz–3.3 V		Units
	Min	Max	Min	Max	
<b>Interrupts</b>					
<i>Timing Requirements:</i>					
$t_{SIR}$	$\overline{IRQ}_{2-0}$ Setup Before CLKIN High <sup>1</sup>		$18 + 3DT/4$	$18 + 3DT/4$	ns
$t_{HIR}$	$\overline{IRQ}_{2-0}$ Hold Before CLKIN High <sup>1</sup>		$12 + 3DT/4$	$12 + 3DT/4$	ns
$t_{IPW}$	$\overline{IRQ}_{2-0}$ Pulsewidth <sup>2</sup>		$2 + t_{CK}$	$2 + t_{CK}$	ns

**NOTES**

<sup>1</sup>Only required for  $\overline{IRQ}_x$  recognition in the following cycle.

<sup>2</sup>Applies only if  $t_{SIR}$  and  $t_{HIR}$  requirements are not met.

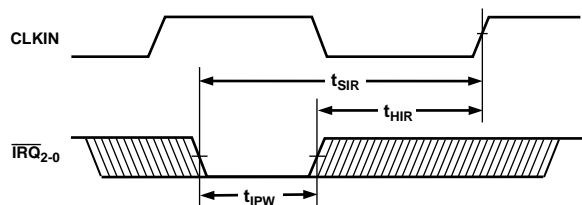

Figure 11. Interrupts



# AD14160/AD14160L

Parameter	40 MHz-5 V		40 MHz-3.3 V		Units
	Min	Max	Min	Max	
<b>Timer</b>					
<i>Switching Characteristic:</i>					
$t_{DTEX}$ CLKIN High to TIMEXP		15.5		15.5	ns

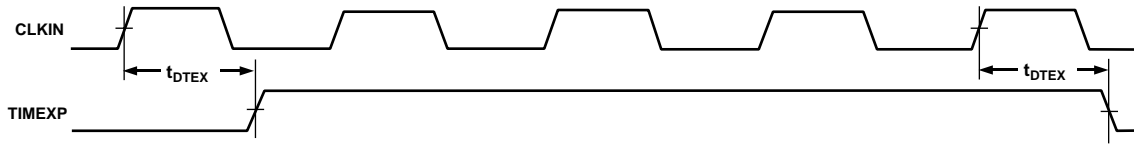

Figure 12. Timer

Parameter	40 MHz-5 V		40 MHz-3.3 V		Units
	Min	Max	Min	Max	
<b>Flags</b>					
<i>Timing Requirements:</i>					
$t_{SFI}$ FLAG3-0 <sub>IN</sub> Setup Before CLKIN High <sup>1</sup>		$8 + 5DT/16$		$8 + 5DT/16$	ns
$t_{HFI}$ FLAG3-0 <sub>IN</sub> Hold After CLKIN High <sup>1</sup>		$0 - 5DT/16$		$0 - 5DT/16$	ns
$t_{DWRFI}$ FLAG3-0 <sub>IN</sub> Delay After RD/WR Low <sup>1</sup>				$5 + 7DT/16$	ns
$t_{HFIWR}$ FLAG3-0 <sub>IN</sub> Hold After RD/WR Deasserted <sup>1</sup>	0.5		0.5	$5 + 7DT/16$	ns
<i>Switching Characteristics:</i>					
$t_{DFO}$ FLAG3-0 <sub>OUT</sub> Delay After CLKIN High		16.5		16.5	ns
$t_{HFO}$ FLAG3-0 <sub>OUT</sub> Hold After CLKIN High	4		4		ns
$t_{DFOE}$ CLKIN High to FLAG3-0 <sub>OUT</sub> Enable	3		3		ns
$t_{DFOD}$ CLKIN High to FLAG3-0 <sub>OUT</sub> Disable		14.5		14.5	ns

**NOTE**

<sup>1</sup>Flag inputs meeting these setup and hold times will affect conditional instructions in the following instruction cycle.

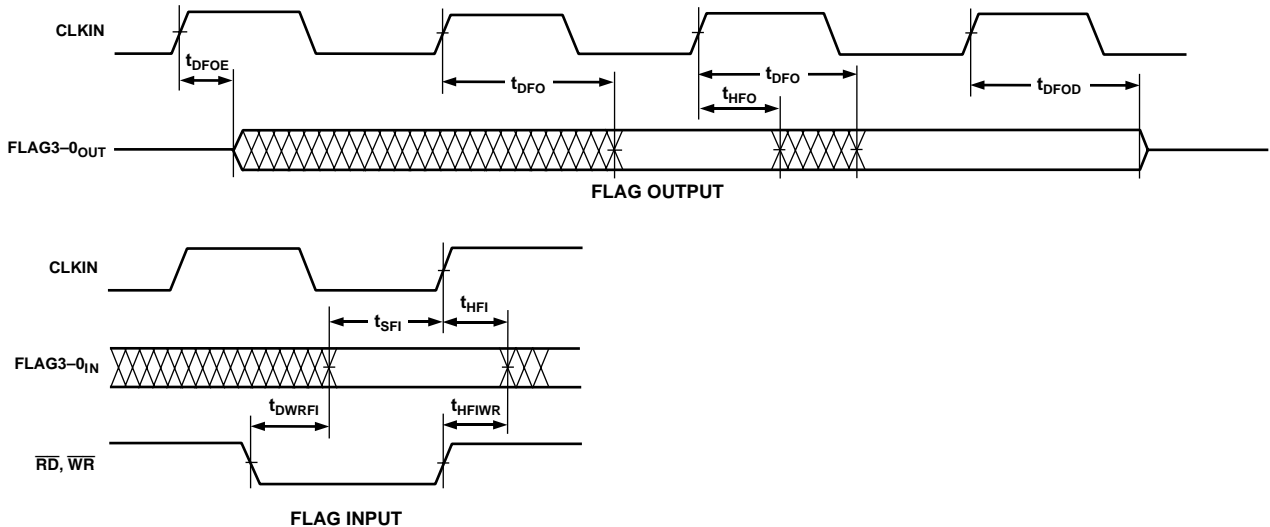

Figure 13. Flags

# AD14160/AD14160L

## Memory Read—Bus Master

Use these specifications for asynchronous interfacing to memories (and memory-mapped peripherals) without reference to CLKIN. These specifications apply when the AD14160/AD14160L is the bus master accessing external memory space.

These switching characteristics also apply for bus master synchronous read/write timing (see Synchronous Read/Write—Bus Master below). If these timing requirements are met, the synchronous read/write timing can be ignored (and vice versa).

Parameter	40 MHz–5 V		40 MHz–3.3 V		Units
	Min	Max	Min	Max	
<i>Timing Requirements:</i>					
$t_{DAD}$ Address, Selects Delay to Data Valid <sup>1, 2</sup>		$17 + DT + W$		$17 + DT + W$	ns
$t_{DRLD}$ $\overline{RD}$ Low to Data Valid <sup>1</sup>		$11 + 5DT/8 + W$		$11 + 5DT/8 + W$	ns
$t_{HDA}$ Data Hold from Address <sup>3</sup>	1.5		1.5		ns
$t_{HDRH}$ Data Hold from $\overline{RD}$ High <sup>3</sup>	3		3		ns
$t_{DAAK}$ ACK Delay from Address <sup>2, 4</sup>		$13 + 7DT/8 + W$		$13 + 7DT/8 + W$	ns
$t_{DSAK}$ ACK Delay from $\overline{RD}$ Low <sup>4</sup>		$7 + DT/2 + W$		$7 + DT/2 + W$	ns
<i>Switching Characteristics:</i>					
$t_{DRHA}$ Address Hold After $\overline{RD}$ High	$-1 + H$		$-1 + H$		ns
$t_{DARL}$ Address to $\overline{RD}$ Low <sup>2</sup>	$1 + 3DT/8$		$1 + 3DT/8$		ns
$t_{RW}$ $\overline{RD}$ Pulsewidth	$12.5 + 5DT/8 + W$		$12.5 + 5DT/8 + W$		ns
$t_{RWR}$ $\overline{RD}$ High to $\overline{WR}$ , $\overline{RD}$ , $\overline{DMAGx}$ Low	$7.5 + 3DT/8 + HI$		$7.5 + 3DT/8 + HI$		ns
$t_{SADADC}$ Address Setup Before $\overline{ADRCLK}$ High <sup>2</sup>	$-0.5 + DT/4$		$-0.5 + DT/4$		ns

$W$  = (number of wait states specified in WAIT register)  $\times t_{CK}$   
 $HI$  =  $t_{CK}$  (if an address hold cycle or bus idle cycle occurs, as specified in WAIT register; otherwise  $HI = 0$ ).  
 $H$  =  $t_{CK}$  (if an address hold cycle occurs as specified in WAIT register; otherwise  $H = 0$ ).

### NOTES

<sup>1</sup>Data Delay/Setup: User must meet  $t_{DAD}$  or  $t_{DRLD}$  or synchronous spec  $t_{SSDATI}$ .

<sup>2</sup>For  $\overline{MSx}$ ,  $\overline{SW}$ ,  $\overline{BMS}$ , the falling edge is referenced.

<sup>3</sup>Data Hold: User must meet  $t_{HDA}$  or  $t_{HDRH}$  or synchronous spec  $t_{HDATAI}$ . See System Hold Time Calculation under Test Conditions for the calculation of hold times given capacitive and dc loads.

<sup>4</sup>ACK Delay/Setup: User must meet  $t_{DSAK}$  or  $t_{DAAK}$  or synchronous specification  $t_{SACKC}$ .

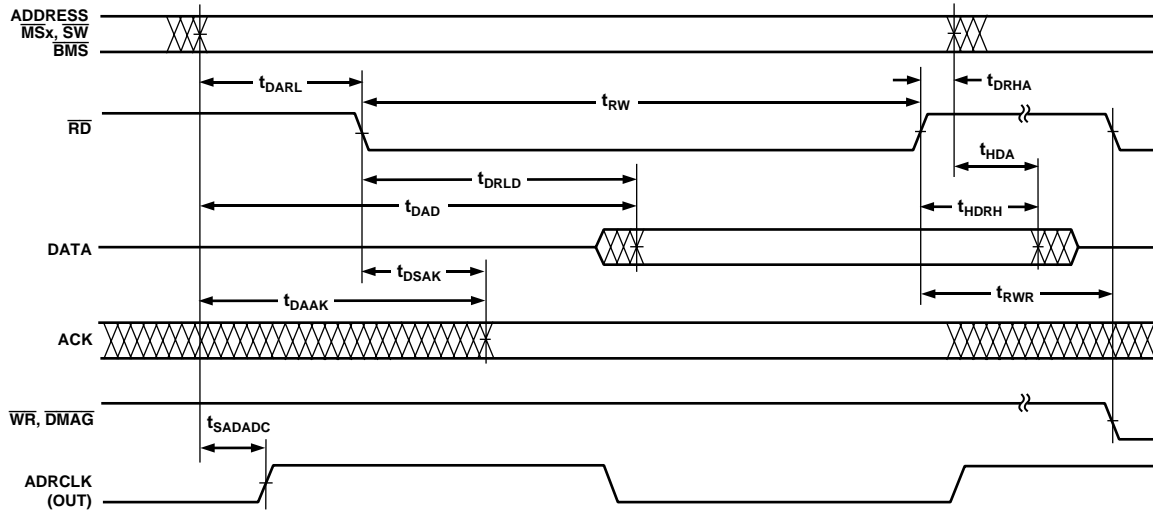

Figure 14. Memory Read—Bus Master

## Memory Write—Bus Master

Use these specifications for asynchronous interfacing to memories (and memory-mapped peripherals) without reference to CLKIN. These specifications apply when the AD14160/AD14160L is the bus master accessing external memory space.

These switching characteristics also apply for bus master synchronous read/write timing (see Synchronous Read/Write—Bus Master). If these timing requirements are met, the synchronous read/write timing can be ignored (and vice versa).

Parameter	40 MHz–5 V		40 MHz–3.3 V		Units
	Min	Max	Min	Max	
<i>Timing Requirements:</i>					
$t_{DAAK}$	ACK Delay from Address, Selects <sup>1,2</sup>		13 + 7DT/8 + W		ns
$t_{DSAK}$	ACK Delay from $\overline{WR}$ Low <sup>1</sup>		7 + DT/2 + W		ns
<i>Switching Characteristics:</i>					
$t_{DAWH}$	Address, Selects to $\overline{WR}$ Deasserted <sup>2</sup>		16 + 15DT/16 + W		ns
$t_{DAWL}$	Address, Selects to $\overline{WR}$ Low <sup>2</sup>		2 + 3DT/8		ns
$t_{WW}$	$\overline{WR}$ Pulsewidth		12 + 9DT/16 + W		ns
$t_{DDWH}$	Data Setup Before $\overline{WR}$ High		6 + DT/2 + W		ns
$t_{DWH}$	Address Hold After $\overline{WR}$ Deasserted		0 + DT/16 + H		ns
$t_{DATRWH}$	Data Disable After $\overline{WR}$ Deasserted <sup>3</sup>		0.5 + DT/16 + H		ns
$t_{WWR}$	$\overline{WR}$ High to $\overline{WR}$ , $\overline{RD}$ , $\overline{DMAG}$ Low		7.5 + 7DT/16 + H		ns
$t_{DDWR}$	Data Disable Before $\overline{WR}$ or $\overline{RD}$ Low		4 + 3DT/8 + I		ns
$t_{WDE}$	$\overline{WR}$ Low to Data Enabled		-1.5 + DT/16		ns
$t_{SADADC}$	Address, Selects to $\overline{ADRCLK}$ High <sup>2</sup>		-0.5 + DT/4		ns

W = (number of wait states specified in WAIT register) ×  $t_{CK}$ .  
H =  $t_{CK}$  (if an address hold cycle occurs, as specified in WAIT register; otherwise H = 0).  
I =  $t_{CK}$  (if a bus idle cycle occurs, as specified in WAIT register; otherwise I = 0).

### NOTES

<sup>1</sup>ACK Delay/Setup: User must meet  $t_{DAAK}$  or  $t_{DSAK}$  or synchronous specification  $t_{SACKC}$ .

<sup>2</sup>For  $\overline{MSx}$ ,  $\overline{SW}$ ,  $\overline{BMS}$ , the falling edge is referenced.

<sup>3</sup>See System Hold Time Calculation under Test Conditions for calculation of hold times given capacitive and dc loads.

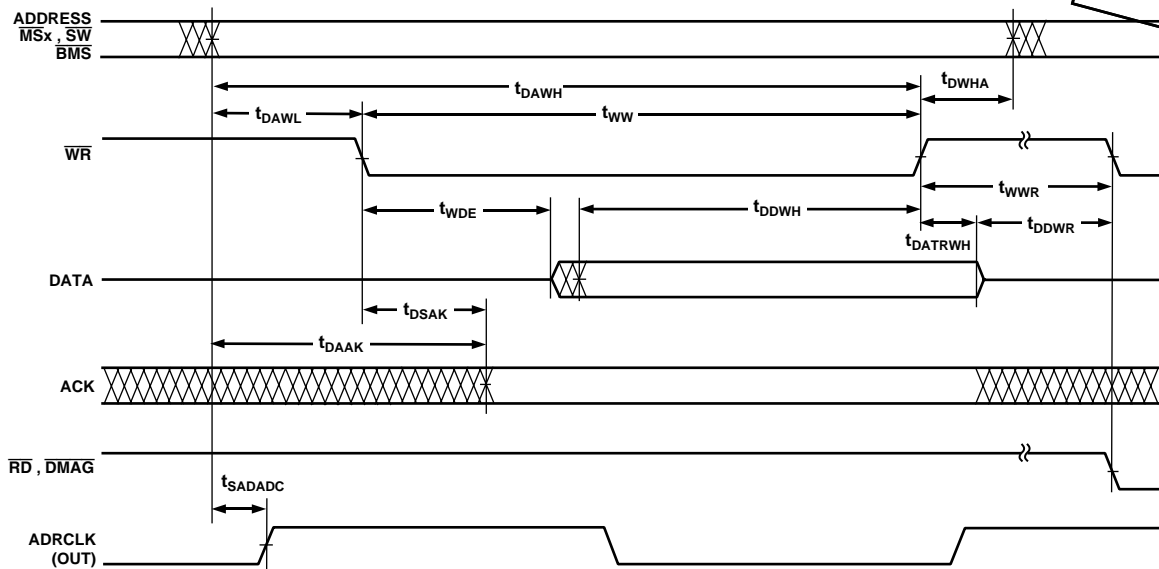

Figure 15. Memory Write—Bus Master

# AD14160/AD14160L

## Synchronous Read/Write—Bus Master

Use these specifications for interfacing to external memory systems that require CLKIN—relative timing or for accessing a slave ADSP-2106x (in multiprocessor memory space). These synchronous switching characteristics are also valid during asynchronous memory reads and writes (see Memory Read—Bus Master and Memory Write—Bus Master).

When accessing a slave ADSP-2106x, these switching characteristics must meet the slave's timing requirements for synchronous read/writes (see Synchronous Read/Write—Bus Slave). The slave ADSP-2106x must also meet these (bus master) timing requirements for data and acknowledge setup and hold times.

Parameter	40 MHz–5 V		40 MHz–3.3 V		Units
	Min	Max	Min	Max	
<i>Timing Requirements:</i>					
t <sub>SSDATI</sub> Data Setup Before CLKIN	3.5 + DT/8		3.5 + DT/8		ns
t <sub>HSDATI</sub> Data Hold After CLKIN	3.5 – DT/8		3.5 – DT/8		ns
t <sub>DAACK</sub> ACK Delay After Address, $\overline{MSx}$ , $\overline{SW}$ , $\overline{BMS}$ <sup>1,2</sup>	13 + 7 DT/8 + W		13 + 7 DT/8 + W		ns
t <sub>SACKC</sub> ACK Setup Before CLKIN <sup>2</sup>	7 + DT/4		7 + DT/4		ns
t <sub>HACKC</sub> ACK Hold After CLKIN	–1 – DT/4		–1 – DT/4		ns
<i>Switching Characteristics:</i>					
t <sub>DADRO</sub> Address, $\overline{MSx}$ , $\overline{BMS}$ , $\overline{SW}$ Delay After CLKIN <sup>1</sup>	8 – DT/8		8 – DT/8		ns
t <sub>HADRO</sub> Address, $\overline{MSx}$ , $\overline{BMS}$ , $\overline{SW}$ Hold After CLKIN	–1 – DT/8		–1 – DT/8		ns
t <sub>DPGC</sub> PAGE Delay After CLKIN	9 + DT/8		9 + DT/8		ns
t <sub>DRDO</sub> $\overline{RD}$ High Delay After CLKIN	–2 – DT/8		–2 – DT/8		ns
t <sub>DWRO</sub> $\overline{WR}$ High Delay After CLKIN	–3 – 3DT/16		–3 – 3DT/16		ns
t <sub>DRWL</sub> $\overline{RD}/\overline{WR}$ Low Delay After CLKIN	8 + DT/4		8 + DT/4		ns
t <sub>SDDATO</sub> Data Delay After CLKIN	20 + 5DT/16		20 + 5DT/16		ns
t <sub>DATTR</sub> Data Disable After CLKIN <sup>3</sup>	0 – DT/8		0 – DT/8		ns
t <sub>DADCK</sub> ADRCLK Delay After CLKIN	4 + DT/8		4 + DT/8		ns
t <sub>ADRCK</sub> ADRCLK Period	t <sub>CK</sub>		t <sub>CK</sub>		ns
t <sub>ADRCKH</sub> ADRCLK Width High	(t <sub>CK</sub> /2 – 2)		(t <sub>CK</sub> /2 – 2)		ns
t <sub>ADRCKL</sub> ADRCLK Width Low	(t <sub>CK</sub> /2 – 2)		(t <sub>CK</sub> /2 – 2)		ns

W = (number of Wait states specified in WAIT register) × t<sub>CK</sub>.

### NOTES

<sup>1</sup>For  $\overline{MSx}$ ,  $\overline{SW}$ ,  $\overline{BMS}$ , the falling edge is referenced.

<sup>2</sup>ACK Delay/Setup: User must meet t<sub>DAACK</sub> or t<sub>DSAK</sub> or synchronous specification t<sub>SACKC</sub>.

<sup>3</sup>See System Hold Time Calculation under Test Conditions for calculation of hold times given capacitive and dc loads.

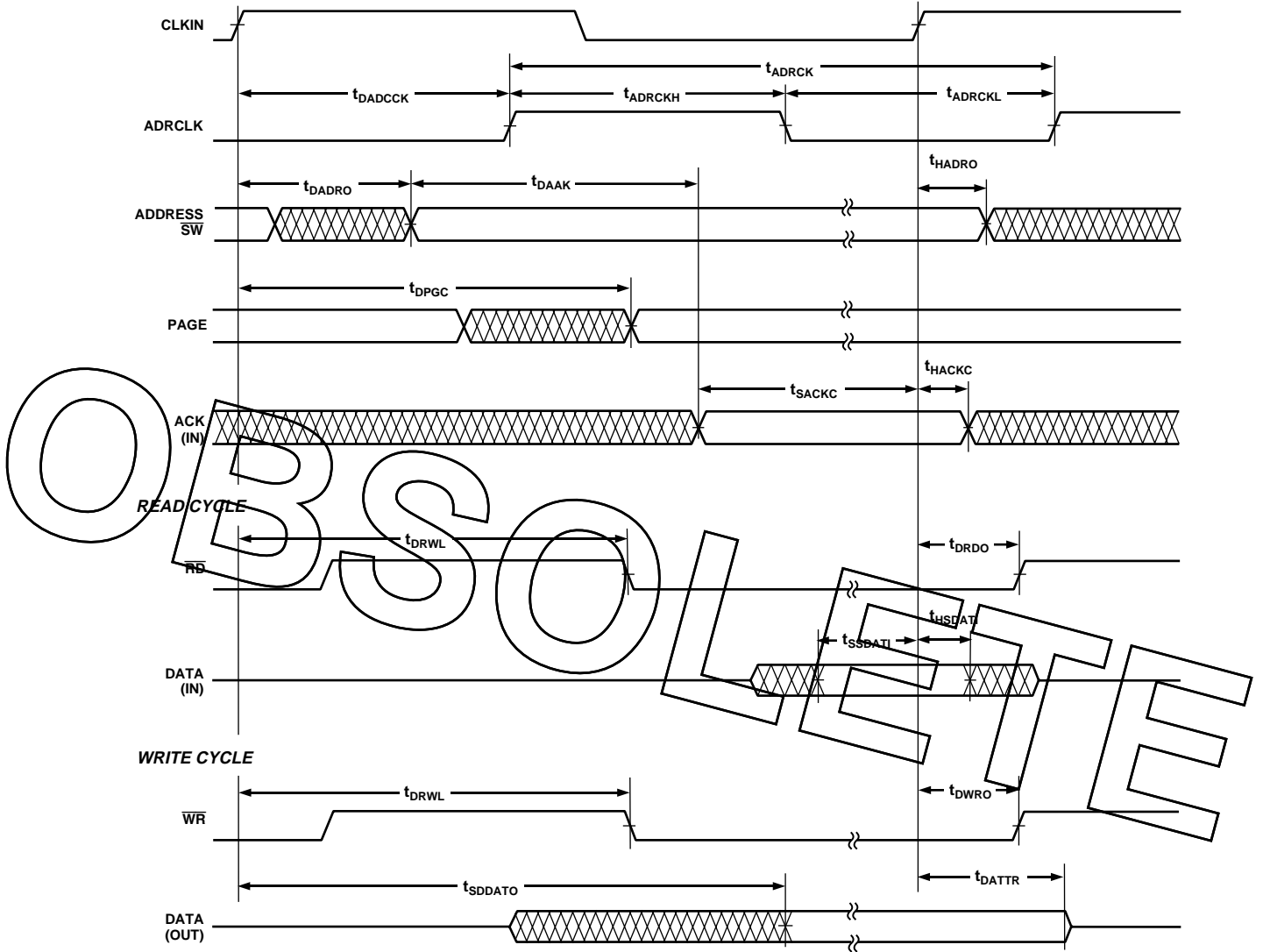

Figure 16. Synchronous Read/Write—Bus Master

# AD14160/AD14160L

## Synchronous Read/Write—Bus Slave

The bus master must meet these (bus slave) timing requirements.

Use these specifications for bus master accesses of a slave's IOP registers or internal memory (in multiprocessor memory space).

Parameter	40 MHz–5 V		40 MHz–3.3 V		Units
	Min	Max	Min	Max	
<i>Timing Requirements:</i>					
$t_{SADRI}$	Address, $\overline{SW}$ Setup Before CLKIN		15.5 + DT/2		ns
$t_{HADRI}$	Address, $\overline{SW}$ Hold Before CLKIN		5 + DT/2		ns
$t_{SRWLI}$	$\overline{RD}/\overline{WR}$ Low Setup Before CLKIN <sup>1</sup>		10 + 5DT/16		ns
$t_{HRWLI}$	$\overline{RD}/\overline{WR}$ Low Hold After CLKIN		-4 - 5DT/16    7.5 + 7DT/16		ns
$t_{RWHPI}$	$\overline{RD}/\overline{WR}$ Pulse High		3		ns
$t_{SDATWH}$	Data Setup Before $\overline{WR}$ High		6		ns
$t_{HDATWH}$	Data Hold After $\overline{WR}$ High		1.5		ns
<i>Switching Characteristics:</i>					
$t_{SDDATO}$	Data Delay After CLKIN		20 + 5DT/16		ns
$t_{DATTR}$	Data Disable After CLKIN <sup>2</sup>		0 - DT/8    8 - DT/8		ns
$t_{DACKAD}$	ACK Delay After Address, $\overline{SW}$ <sup>3</sup>		10		ns
$t_{ACKTR}$	ACK Disable After CLKIN <sup>3</sup>		-1 - DT/8    7 - DT/8		ns

### NOTES

<sup>1</sup> $t_{SRWLI}$  (min) = 10 + 5DT/16 when Multiprocessor Memory Space Wait State (MMSWS bit in WAIT register) is disabled; when MMSWS is enabled,  $t_{SRWLI}$  (min) = 4.5 + DT/8.

<sup>2</sup>See System Hold Time Calculation under Test Conditions for calculation of hold times given capacitive and dc loads.

<sup>3</sup> $t_{DACKAD}$  is true only if the address and  $\overline{SW}$  inputs have setup times (before CLKIN) greater than 10.5 + DT/8 and less than 19 + 3DT/4. If the address and  $\overline{SW}$  inputs have setup times greater than 19 + 3DT/4, then ACK is valid 15 + DT/4 (max) after CLKIN. A slave that sees an address with an M field match will respond with ACK regardless of the state of MMSWS or strobes. A slave will three-state ACK every cycle with  $t_{ACKTR}$ .

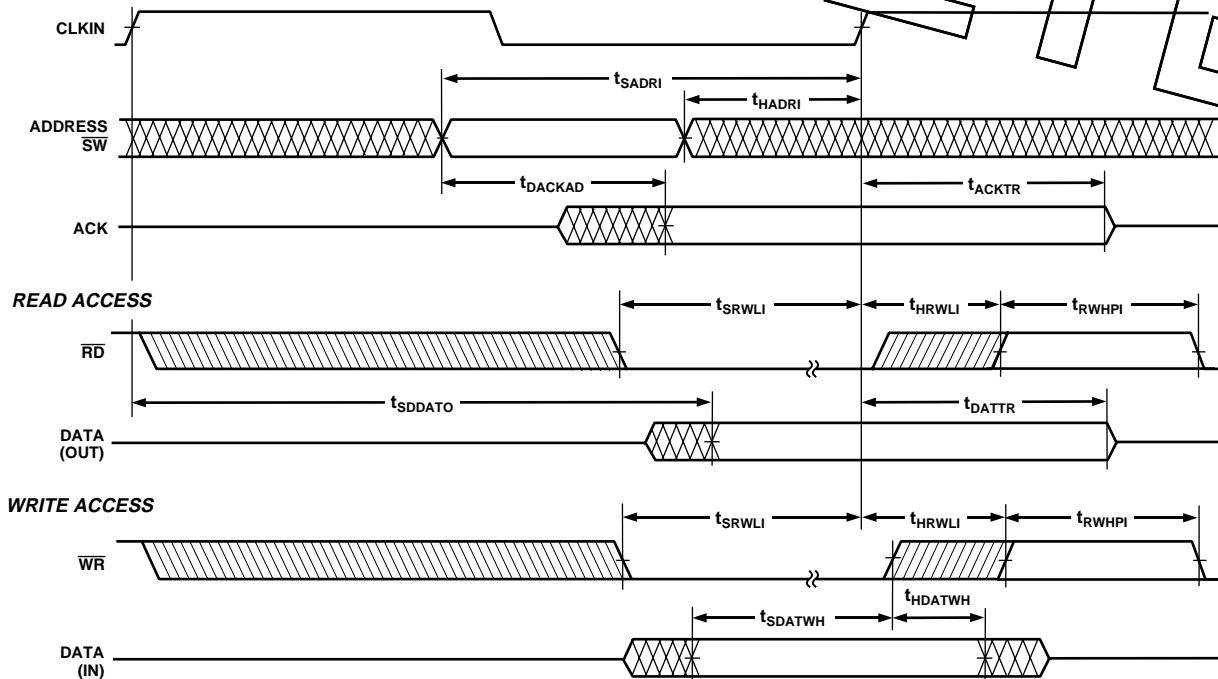

Figure 17. Synchronous Read/Write—Bus Slave

**Multiprocessor Bus Request and Host Bus Request**

Use these specifications for passing of bus mastership between multiprocessing ADSP-2106x's ( $\overline{BRx}$ ) or a host processor ( $\overline{HBR}$ ,  $\overline{HBG}$ ).

Parameter	40 MHz–5 V		40 MHz–3.3 V		Units
	Min	Max	Min	Max	
<i>Timing Requirements:</i>					
$t_{HBGRCSV}$	$\overline{HBG}$ Low to $\overline{RD}/\overline{WR}/\overline{CS}$ Valid <sup>1</sup>				ns
$t_{SHBRI}$	$20 + 3DT/4$	$19.5 + 5DT/4$	$20 + 3DT/4$	$19.5 + 5DT/4$	ns
$t_{HHBRI}$	$\overline{HBR}$ Setup Before $\overline{CLKIN}$ <sup>2</sup>		$20 + 3DT/4$	$14 + 3DT/4$	ns
$t_{HHBRI}$	$\overline{HBR}$ Hold Before $\overline{CLKIN}$ <sup>2</sup>		$13 + DT/2$	$14 + 3DT/4$	ns
$t_{SHBGI}$	$\overline{HBG}$ Setup Before $\overline{CLKIN}$		$13 + DT/2$	$6 + DT/2$	ns
$t_{HHBGI}$	$\overline{HBG}$ Hold Before $\overline{CLKIN}$ High		$13.5 + DT/2$	$6 + DT/2$	ns
$t_{SBRI}$	$\overline{BRx}$ , $\overline{CPA}$ Setup Before $\overline{CLKIN}$ <sup>3</sup>		$13.5 + DT/2$	$6 + DT/2$	ns
$t_{HBRI}$	$\overline{BRx}$ , $\overline{CPA}$ Hold Before $\overline{CLKIN}$ High		$21.5 + 3DT/4$	$6 + DT/2$	ns
$t_{SRPBAI}$	$\overline{RPBA}$ Setup Before $\overline{CLKIN}$		$21.5 + 3DT/4$	$12 + 3DT/4$	ns
$t_{HRPBAI}$	$\overline{RPBA}$ Hold Before $\overline{CLKIN}$		$12 + 3DT/4$	$12 + 3DT/4$	ns
<i>Switching Characteristics:</i>					
$t_{DHBGO}$	$\overline{HBG}$ Delay After $\overline{CLKIN}$		$7.5 - DT/8$	$7.5 - DT/8$	ns
$t_{HHBGO}$	$\overline{HBG}$ Hold After $\overline{CLKIN}$		$-2 - DT/8$	$-2 - DT/8$	ns
$t_{DBRO}$	$\overline{BRx}$ Delay After $\overline{CLKIN}$		$8 - DT/8$	$8 - DT/8$	ns
$t_{HBRO}$	$\overline{BRx}$ Hold After $\overline{CLKIN}$		$-2 - DT/8$	$-2 - DT/8$	ns
$t_{DCPAO}$	$\overline{CPA}$ Low Delay After $\overline{CLKIN}$		$8.5 - DT/8$	$8.5 - DT/8$	ns
$t_{TRCPA}$	$\overline{CPA}$ Disable After $\overline{CLKIN}$		$5 - DT/8$	$5 - DT/8$	ns
$t_{DRDYCS}$	$\overline{REDY}$ (O/D) or (A/D) Low from $\overline{CS}$ and $\overline{HBR}$ Low <sup>4</sup>		9.5	10.25	ns
$t_{TRDYHG}$	$\overline{REDY}$ (O/D) Disable or $\overline{REDY}$ (A/D) High from $\overline{HBG}$ <sup>4</sup>		$43.5 + 27DT/16$	$43.5 + 27DT/16$	ns
$t_{ARDYTR}$	$\overline{REDY}$ (A/D) Disable from $\overline{CS}$ or $\overline{HBR}$ High <sup>4</sup>		11	11	ns

NOTES

<sup>1</sup>For first asynchronous access after  $\overline{HBR}$  and  $\overline{CS}$  asserted,  $\overline{ADDR}_{31-0}$  must be a non-MMS value  $1/2 t_{CR}$  before  $\overline{RD}$  or  $\overline{WR}$  goes low or by  $t_{HBGRCSV}$  after  $\overline{HBG}$  goes low. This is easily accomplished by driving an upper address signal high when  $\overline{HBG}$  is asserted.

<sup>2</sup>Only required for recognition in the current cycle.

<sup>3</sup> $\overline{CPA}$  assertion must meet the setup to  $\overline{CLKIN}$ ; deassertion does not need to meet the setup to  $\overline{CLKIN}$ .

<sup>4</sup>(O/D) = open drain, (A/D) = active drive.

# AD14160/AD14160L

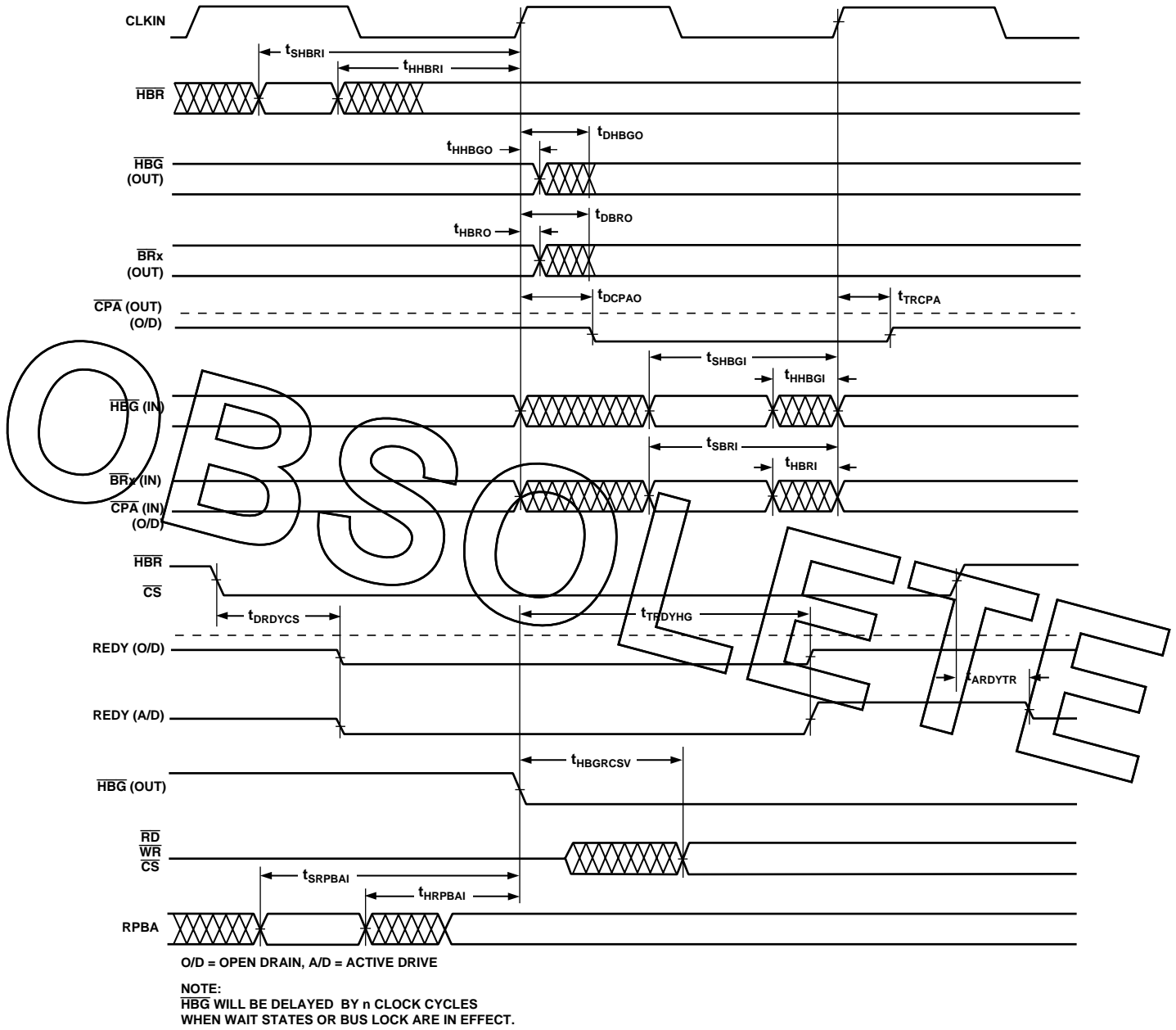

Figure 18. Multiprocessor Bus Request and Host Bus Request



### Asynchronous Read/Write—Host to AD14160/AD14160L

Use these specifications for asynchronous host processor accesses of an AD14160/AD14160L, after the host has asserted  $\overline{CS}$  and  $\overline{HBR}$  (low). After  $\overline{HBG}$  is returned by the AD14160/AD14160L,

the host can drive the  $\overline{RD}$  and  $\overline{WR}$  pins to access the AD14160/AD14160L's internal memory or IOP registers.  $\overline{HBR}$  and  $\overline{HBG}$  are assumed low for this timing.

Parameter	40 MHz–5 V		40 MHz–3.3 V		Units
	Min	Max	Min	Max	
<b>Lead Cycle</b>					
<i>Timing Requirements:</i>					
$t_{SADRDL}$	Address Setup/ $\overline{CS}$ Low Before $\overline{RD}$ Low <sup>1</sup>		1		ns
$t_{HADRDH}$	Address Hold/ $\overline{CS}$ Hold Low After $\overline{RD}$		1		ns
$t_{WRWH}$	$\overline{RD}/\overline{WR}$ High Width		6		ns
$t_{DRDHRDY}$	$\overline{RD}$ High Delay After REDI (O/D) Disable		0.5		ns
$t_{DRDHRDY}$	$\overline{RD}$ High Delay After REDI (A/D) Disable		0.5		ns
<i>Switching Characteristics:</i>					
$t_{SDATRDY}$	Data Valid Before REDI Disable from Low		1		ns
$t_{DRDYRDI}$	REDI (O/D) or (A/D) Low Delay After $\overline{RD}$ Low			11	ns
$t_{RDYPRD}$	REDI (O/D) or (A/D) Low Pulsewidth for Read		45 + DT		ns
$t_{HDARWH}$	Data Disable After $\overline{RD}$ High		2	9.5	ns
<b>Write Cycle</b>					
<i>Timing Requirements:</i>					
$t_{SCSWRL}$	$\overline{CS}$ Low Setup Before $\overline{WR}$ Low		0	0	ns
$t_{HCSWRH}$	$\overline{CS}$ Low Hold After $\overline{WR}$ High		0.5	0.5	ns
$t_{SADWRH}$	Address Setup Before $\overline{WR}$ High		6	6	ns
$t_{HADWRH}$	Address Hold After $\overline{WR}$ High		2.5	2.5	ns
$t_{WWRL}$	$\overline{WR}$ Low Width		7	7	ns
$t_{WRWH}$	$\overline{RD}/\overline{WR}$ High Width		6	6	ns
$t_{DWRHRDY}$	$\overline{WR}$ High Delay After REDI (O/D) or (A/D) Disable		0.5	0.5	ns
$t_{SDATWH}$	Data Setup Before $\overline{WR}$ High		6	6	ns
$t_{HDATWH}$	Data Hold After $\overline{WR}$ High		1.5	1.5	ns
<i>Switching Characteristics:</i>					
$t_{DRDYWRL}$	REDI (O/D) or (A/D) Low Delay After $\overline{WR}/\overline{CS}$ Low			11	ns
$t_{RDYPPWR}$	REDI (O/D) or (A/D) Low Pulsewidth for Write		15		ns
$t_{SRDYCK}$	REDI (O/D) or (A/D) Disable to CLKIN		0.5 + 7DT/16	8 + 7DT/16	ns

**NOTE**

<sup>1</sup>Not required if  $\overline{RD}$  and address are valid  $t_{HBGRCSV}$  after  $\overline{HBG}$  goes low. For first access after  $\overline{HBR}$  asserted,  $ADDR_{31-0}$  must be a non-MMS value  $1/2 t_{CLK}$  before  $\overline{RD}$  or  $\overline{WR}$  goes low or by  $t_{HBGRCSV}$  after  $\overline{HBG}$  goes low. This is easily accomplished by driving an upper address signal high when  $\overline{HBG}$  is asserted. For address bits to be driven during asynchronous host accesses, see Table 8.2 of the ADSP-2106x SHARC User's Manual.

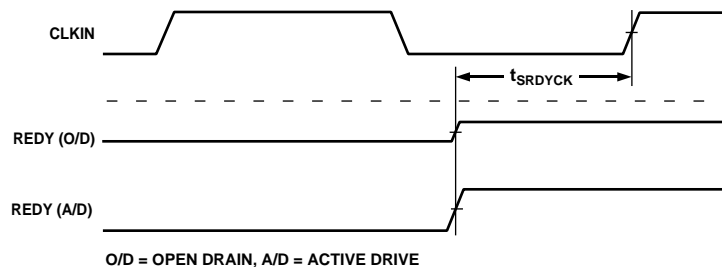

Figure 19a. Synchronous REDI Timing

# AD14160/AD14160L

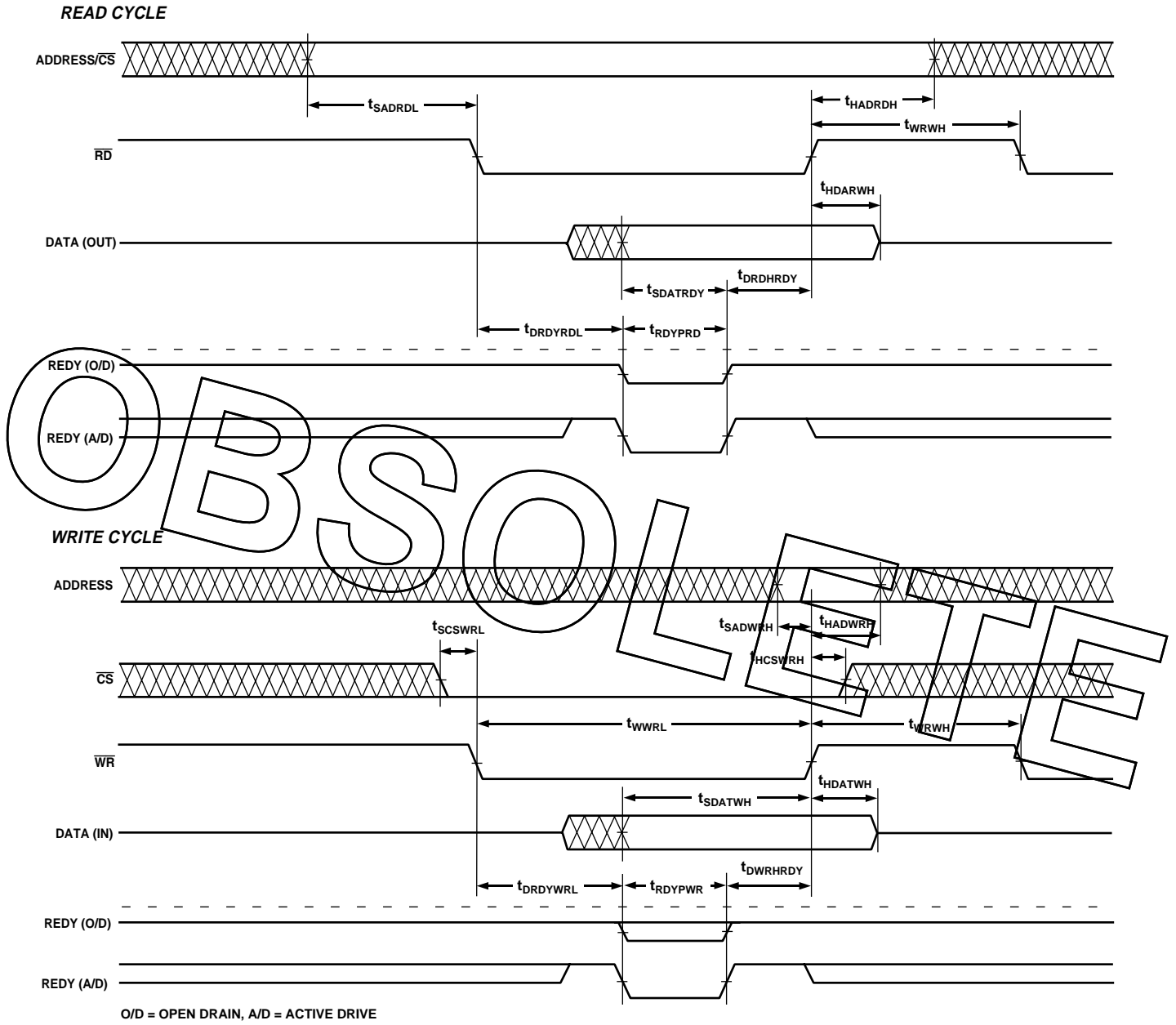

Figure 19b. Asynchronous Read/Write—Host to ADSP-2106x

**Three-State Timing—Bus Master, Bus Slave,  $\overline{\text{HBR}}$ ,  $\overline{\text{SBTS}}$**

These specifications show how the memory interface is disabled (stops driving) or enabled (resumes driving) relative to CLKIN and the  $\overline{\text{SBTS}}$  pin. This timing is applicable to bus master transition cycles (BTC) and host transition cycles (HTC) as well as the  $\overline{\text{SBTS}}$  pin.

Parameter	40 MHz–5 V		40 MHz–3.3 V		Units
	Min	Max	Min	Max	
<i>Timing Requirements:</i>					
$t_{\text{STCK}}$	$\overline{\text{SBTS}}$ Setup Before CLKIN		12 + DT/2	6 + DT/2	ns
$t_{\text{HTCK}}$	$\overline{\text{SBTS}}$ Hold Before CLKIN			6 + DT/2	ns
<i>Switching Characteristics:</i>					
$t_{\text{MIENA}}$	Address/Select Enable After CLKIN		-1.5 - DT/8	-1.25 - DT/8	ns
$t_{\text{MIENS}}$	Strobes Enable After CLKIN <sup>1</sup>		-1.5 - DT/8	-1.5 - DT/8	ns
$t_{\text{MIENHG}}$	$\overline{\text{HBG}}$ Enable After CLKIN		-1.5 - DT/8	-1.5 - DT/8	ns
$t_{\text{MITRA}}$	Address/Select Disable After CLKIN			1 - DT/4	ns
$t_{\text{MITRS}}$	Strobes Disable After CLKIN		2.5 - DT/4	2.5 - DT/4	ns
$t_{\text{MITRHG}}$	$\overline{\text{HBG}}$ Disable After CLKIN		2.5 - DT/4	2.5 - DT/4	ns
$t_{\text{DATEN}}$	Data Enable After CLKIN <sup>2</sup>		9 + 5DT/16	9 + 5DT/16	ns
$t_{\text{DATTR}}$	Data Disable After CLKIN <sup>2</sup>		0 - DT/8	8 - DT/8	ns
$t_{\text{ACKEN}}$	ACK Enable After CLKIN <sup>2</sup>		7.5 + DT/4	7.5 + DT/4	ns
$t_{\text{ACKTR}}$	ACK Disable After CLKIN <sup>2</sup>		-1 - DT/8	7 - DT/8	ns
$t_{\text{ADCN}}$	ADRCLK Enable After CLKIN		-2 - DT/8	2 - DT/8	ns
$t_{\text{ADCTR}}$	ADRCLK Disable After CLKIN			8.5 - DT/4	ns
$t_{\text{MTRHBG}}$	Memory Interface Disable Before $\overline{\text{HBG}}$ Low <sup>3</sup>		-0.5 + DT/8	-0.5 + DT/8	ns
$t_{\text{MENHBG}}$	Memory Interface Enable After $\overline{\text{HBG}}$ High <sup>3</sup>		18.5 + DT	18.5 + DT	ns

NOTES

<sup>1</sup>Strobes =  $\overline{\text{RD}}$ ,  $\overline{\text{WR}}$ ,  $\overline{\text{SW}}$ , PAGE,  $\overline{\text{DMAG}}$ .

<sup>2</sup>In addition to bus master transition cycles, these specs also apply to bus master and bus slave synchronous read/write.

<sup>3</sup>Memory Interface = Address,  $\overline{\text{RD}}$ ,  $\overline{\text{WR}}$ ,  $\overline{\text{MSx}}$ ,  $\overline{\text{SW}}$ ,  $\overline{\text{HBG}}$ , PAGE,  $\overline{\text{DMAGx}}$ , BMS (in EPROM boot mode).

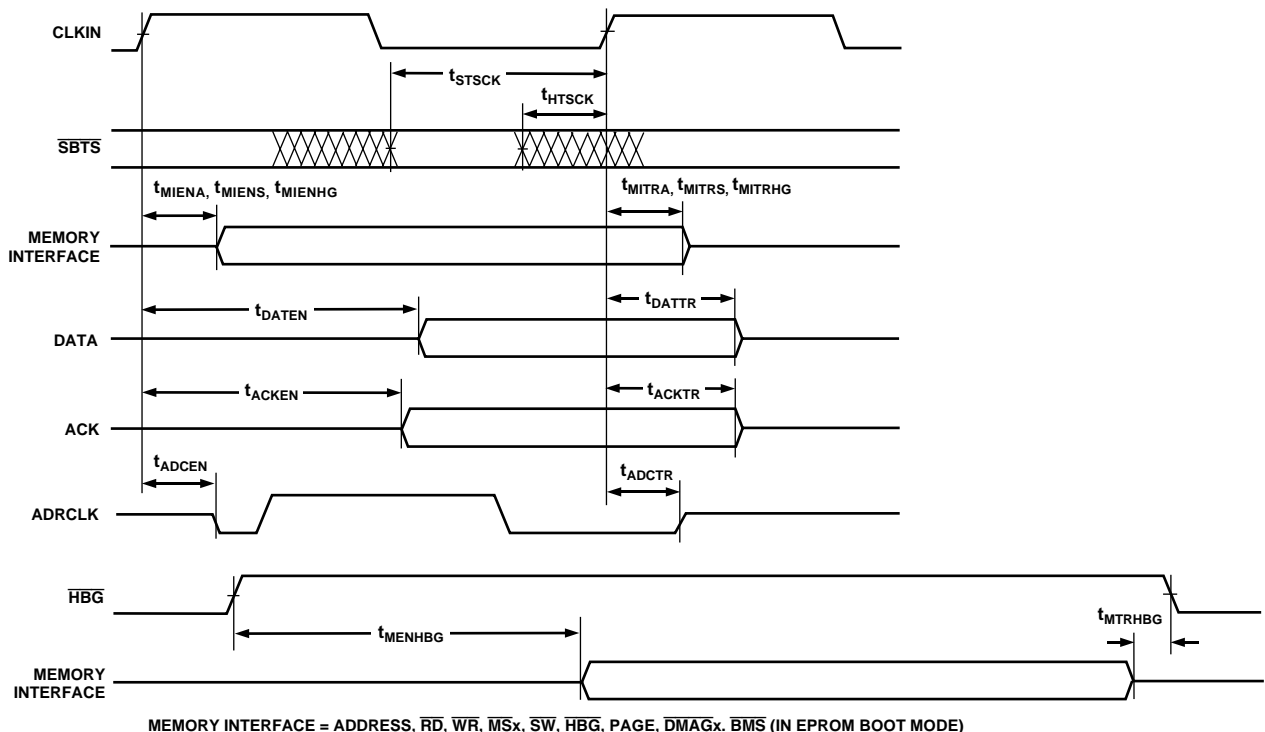

MEMORY INTERFACE = ADDRESS,  $\overline{\text{RD}}$ ,  $\overline{\text{WR}}$ ,  $\overline{\text{MSx}}$ ,  $\overline{\text{SW}}$ ,  $\overline{\text{HBG}}$ , PAGE,  $\overline{\text{DMAGx}}$ , BMS (IN EPROM BOOT MODE)

Figure 20. Three-State Timing

# AD14160/AD14160L

## DMA Handshake

These specifications describe the three DMA handshake modes. In all three modes  $\overline{\text{DMAR}}$  is used to initiate transfers. For handshake mode,  $\overline{\text{DMAG}}$  controls the latching or enabling of data externally. For external handshake mode, the data transfer is controlled by the  $\overline{\text{ADDR}}_{31-0}$ ,  $\overline{\text{RD}}$ ,  $\overline{\text{WR}}$ ,  $\overline{\text{SW}}$ ,  $\text{PAGE}$ ,  $\overline{\text{MS}}_{3-0}$ ,  $\text{ACK}$ , and  $\overline{\text{DMAG}}$  signals. For Paced Master mode, the data

transfer is controlled by  $\overline{\text{ADDR}}_{31-0}$ ,  $\overline{\text{RD}}$ ,  $\overline{\text{WR}}$ ,  $\overline{\text{MS}}_{3-0}$ , and  $\text{ACK}$  (not  $\overline{\text{DMAG}}$ ). For Paced Master mode, the “Memory Read–Bus Master”, “Memory Write–Bus Master”, and “Synchronous Read/Write–Bus Master” timing specifications for  $\overline{\text{ADDR}}_{31-0}$ ,  $\overline{\text{RD}}$ ,  $\overline{\text{WR}}$ ,  $\overline{\text{MS}}_{3-0}$ ,  $\overline{\text{SW}}$ ,  $\text{PAGE}$ ,  $\text{DATA}_{47-0}$ , and  $\text{ACK}$  also apply.

Parameter	40 MHz–5 V		40 MHz–3.3 V		Units	
	Min	Max	Min	Max		
<i>Timing Requirements:</i>						
$t_{\text{SDRLC}}$	$\overline{\text{DMARx}}$ Low Setup Before $\text{CLKIN}^1$	5.5		5.5	ns	
$t_{\text{SDRHC}}$	$\overline{\text{DMARx}}$ High Setup Before $\text{CLKIN}^1$	5.5		5.5	ns	
$t_{\text{WDR}}$	$\overline{\text{DMARx}}$ Width Low (Nonsynchronous)	6		6	ns	
$t_{\text{SDATDGL}}$	Data Setup After $\overline{\text{DMAGx}}$ Low <sup>2</sup>		$9 + 5\text{DT}/8$	$9 + 5\text{DT}/8$	ns	
$t_{\text{HDATDGH}}$	Data Hold After $\overline{\text{DMAGx}}$ High	2.5		2.5	ns	
$t_{\text{DATDRH}}$	Data Valid After $\overline{\text{DMAGx}}$ High <sup>2</sup>		$15 + 7\text{DT}/8$	$15 + 7\text{DT}/8$	ns	
$t_{\text{DMARLL}}$	$\overline{\text{DMAGx}}$ Low Edge to Low Edge	$23 + 7\text{DT}/8$		$23 + 7\text{DT}/8$	ns	
$t_{\text{DMARH}}$	$\overline{\text{DMAGx}}$ Width High	6		6	ns	
<i>Switching Characteristics:</i>						
$t_{\text{DDGL}}$	$\overline{\text{DMAGx}}$ Low Delay After $\text{CLKIN}$	$9 + \text{DT}/4$	$16 + \text{DT}/4$	$9 + \text{DT}/4$	$16 + \text{DT}/4$	ns
$t_{\text{WDGH}}$	$\overline{\text{DMAGx}}$ High Width	$6 + 3\text{DT}/8$		$6 + 3\text{DT}/8$		ns
$t_{\text{WDGL}}$	$\overline{\text{DMAGx}}$ Low Width	$12 + 5\text{DT}/8$		$12 + 5\text{DT}/8$		ns
$t_{\text{HDGC}}$	$\overline{\text{DMAGx}}$ High Delay After $\text{CLKIN}$	$-2 - \text{DT}/8$	$7 - \text{DT}/8$	$-2 - \text{DT}/8$	$7 - \text{DT}/8$	ns
$t_{\text{VDATDGH}}$	Data Valid Before $\overline{\text{DMAGx}}$ High <sup>3</sup>	$7 + 9\text{DT}/16$		$7 + 9\text{DT}/16$		ns
$t_{\text{DATRDGH}}$	Data Disable After $\overline{\text{DMAGx}}$ High <sup>4</sup>	-0.5	8	-0.5	8	ns
$t_{\text{DGWRF}}$	$\overline{\text{WR}}$ Low Before $\overline{\text{DMAGx}}$ Low	-0.5	2.5	-0.5	2.5	ns
$t_{\text{DGWRH}}$	$\overline{\text{DMAGx}}$ Low Before $\overline{\text{WR}}$ High	$9.5 + 5\text{DT}/8 + \text{W}$		$9.5 + 5\text{DT}/8 + \text{W}$		ns
$t_{\text{DGWRR}}$	$\overline{\text{WR}}$ High Before $\overline{\text{DMAGx}}$ High	$0.5 + \text{DT}/16$	$3.5 + \text{DT}/16$	$0.5 + \text{DT}/16$	$3.5 + \text{DT}/16$	ns
$t_{\text{DGRDF}}$	$\overline{\text{RD}}$ Low Before $\overline{\text{DMAGx}}$ Low	-0.5	2.5	-0.5	2.5	ns
$t_{\text{DRDGH}}$	$\overline{\text{RD}}$ Low Before $\overline{\text{DMAGx}}$ High	$10.5 + 9\text{DT}/16 + \text{W}$		$10.5 + 9\text{DT}/16 + \text{W}$		ns
$t_{\text{DGRDR}}$	$\overline{\text{RD}}$ High Before $\overline{\text{DMAGx}}$ High	-0.5	3.5	-0.5	3.5	ns
$t_{\text{DGWR}}$	$\overline{\text{DMAGx}}$ High to $\overline{\text{WR}}$ , $\overline{\text{RD}}$ , $\overline{\text{DMAGx}}$ Low	$5 + 3\text{DT}/8 + \text{HI}$		$5 + 3\text{DT}/8 + \text{HI}$		ns
$t_{\text{DADGH}}$	Address/Select Valid to $\overline{\text{DMAGx}}$ High	$16 + \text{DT}$		$16 + \text{DT}$		ns
$t_{\text{DDGHA}}$	Address/Select Hold After $\overline{\text{DMAGx}}$ High	-1.5		-1.5		ns

$\text{W} = (\text{number of wait states specified in WAIT register}) \times t_{\text{CK}}$ .

$\text{HI} = t_{\text{CK}}$  (if an address hold cycle or bus idle cycle occurs, as specified in WAIT register; otherwise  $\text{HI} = 0$ ).

### NOTES

<sup>1</sup>Only required for recognition in the current cycle.

<sup>2</sup> $t_{\text{SDATDGL}}$  is the data setup requirement if  $\overline{\text{DMARx}}$  is not being used to hold off completion of a write. Otherwise, if  $\overline{\text{DMARx}}$  low holds off completion of the write, the data can be driven  $t_{\text{DATDRH}}$  after  $\overline{\text{DMARx}}$  is brought high.

<sup>3</sup> $t_{\text{VDATDGH}}$  is valid if  $\overline{\text{DMARx}}$  is not being used to hold off completion of a read. If  $\overline{\text{DMARx}}$  is used to prolong the read, then  $t_{\text{VDATDGH}} = 7 + 9\text{DT}/16 + (n \times t_{\text{CK}})$  where  $n$  equals the number of extra cycles that the access is prolonged.

<sup>4</sup>See System Hold Time Calculation under Test Conditions for calculation of hold times given capacitive and dc loads.

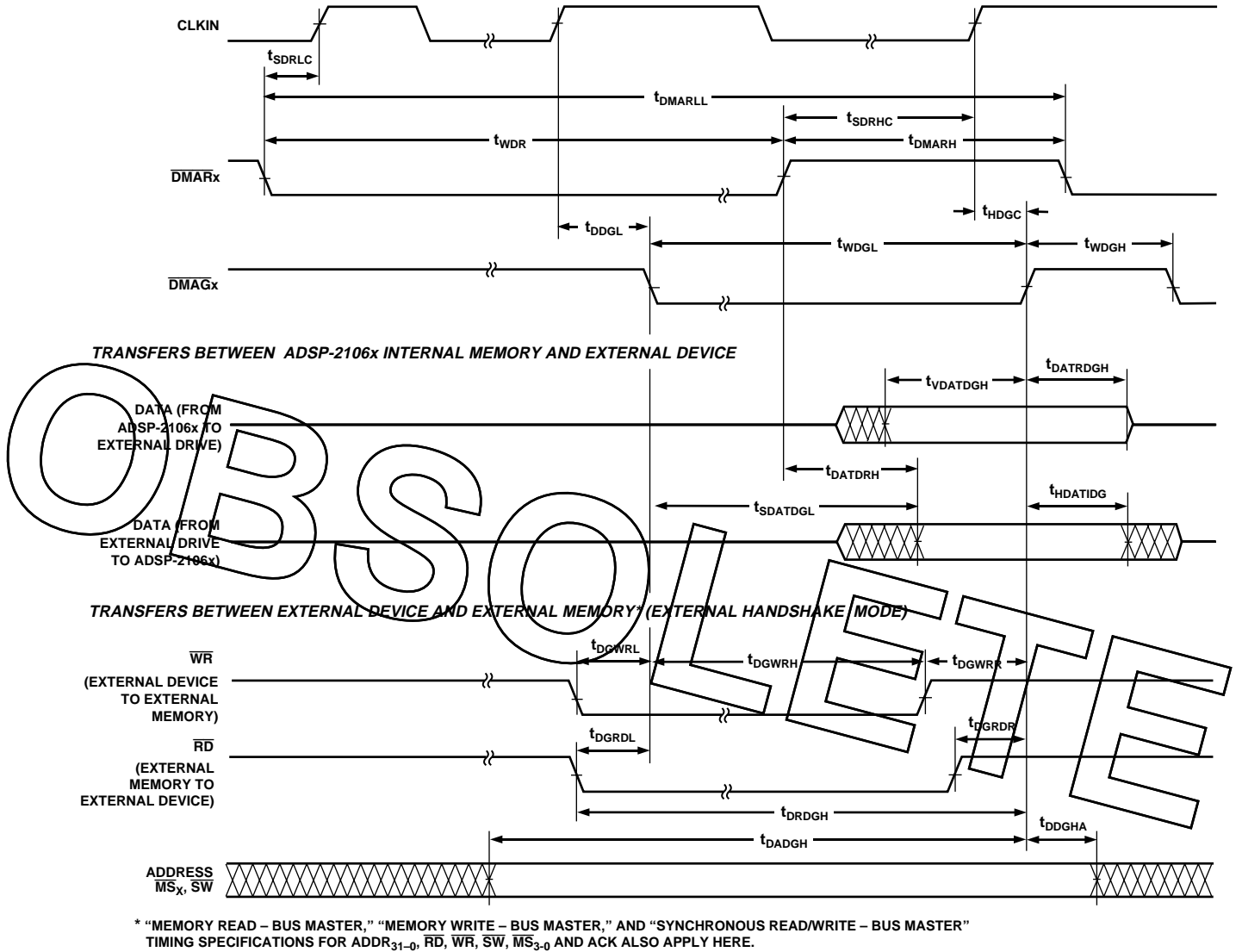

Figure 21. DMA Handshake Timing

# AD14160/AD14160L

## Link Ports: 1 × CLK Speed Operation

Parameter	40 MHz–5 V		40 MHz–3.3 V		Units
	Min	Max	Min	Max	
<b>Receive</b>					
<i>Timing Requirements:</i>					
t <sub>SLDCL</sub>	Data Setup Before LCLK Low		3		ns
t <sub>HLDC</sub>	Data Hold After LCLK Low		3		ns
t <sub>LCLKIW</sub>	LCLK Period (1 × Operation)		t <sub>CK</sub>		ns
t <sub>LCLKRWL</sub>	LCLK Width Low		6		ns
t <sub>LCLKRWH</sub>	LCLK Width High		5		ns
<i>Switching Characteristics:</i>					
t <sub>DLAHC</sub>	LACK High Delay After CLKIN High		18 + DT/2	29 + DT/2	ns
t <sub>DLALC</sub>	LACK Low Delay After LCLK High <sup>1</sup>		-3	13.5	ns
t <sub>ENDLK</sub>	LACK Enable from CLKIN		5 + DT/2		ns
t <sub>TDLK</sub>	LACK Disable from CLKIN			20.5 + DT/2	ns
<b>Transmit</b>					
<i>Timing Requirements:</i>					
t <sub>SLACH</sub>	LACK Setup Before LCLK High		18		ns
t <sub>HLACH</sub>	LACK Hold After LCLK High		-7		ns
<i>Switching Characteristics:</i>					
t <sub>DLCLK</sub>	LCLK Delay After CLKIN (1 × Operation)		16	17	ns
t <sub>DLDC</sub>	Data Delay After LCLK High		3.5	3	ns
t <sub>HLDC</sub>	Data Hold After LCLK High		-3		ns
t <sub>LCLKTWL</sub>	LCLK Width Low		(t <sub>CK</sub> /2) - 2	(t <sub>CK</sub> /2) + 1.25	ns
t <sub>LCLKTWH</sub>	LCLK Width High		(t <sub>CK</sub> /2) - 2	(t <sub>CK</sub> /2) + 1	ns
t <sub>DLACLK</sub>	LCLK Low Delay After LACK High		(t <sub>CK</sub> /2) + 8.5	(3 × t <sub>CK</sub> /2) + 17.5	ns
t <sub>ENDLK</sub>	LDAT, LCLK Enable After CLKIN		5 + DT/2		ns
t <sub>TDLK</sub>	LDAT, LCLK Disable After CLKIN			20.5 + DT/2	ns
<b>Link Port Service Request Interrupts: 1 × and 2 × Speed Operations</b>					
<i>Timing Requirements:</i>					
t <sub>SLCK</sub>	LACK/LCLK Setup Before CLKIN Low <sup>2</sup>		10		ns
t <sub>HLCK</sub>	LACK/LCLK Hold After CLKIN Low <sup>2</sup>		2		ns

### NOTES

<sup>1</sup>LACK will go low with t<sub>DLALC</sub> relative to rising edge of LCLK after first nibble is received. LACK will not go low if the receiver's link buffer is not about to fill.

<sup>2</sup>Only required for interrupt recognition in the current cycle.

## Link Ports: 2 × CLK Speed Operation

Parameter	40 MHz–5 V		40 MHz–3.3 V		Units
	Min	Max	Min	Max	
<b>Receive</b>					
<i>Timing Requirements:</i>					
t <sub>SLDCL</sub>	Data Setup Before LCLK Low		2.5	2.25	ns
t <sub>HLDC</sub>	Data Hold After LCLK Low		2.25	2.25	ns
t <sub>LCLKIW</sub>	LCLK Period (2 × Operation)		t <sub>CK</sub> /2	t <sub>CK</sub> /2	ns
t <sub>LCLKRWL</sub>	LCLK Width Low		4.5	5	ns
t <sub>LCLKRWH</sub>	LCLK Width High		4.25	4	ns
<i>Switching Characteristics:</i>					
t <sub>DLAHC</sub>	LACK High Delay After CLKIN High		18 + DT/2	29 + DT/2	ns
t <sub>DLALC</sub>	LACK Low Delay After LCLK High <sup>1</sup>		6	16.5	ns
<b>Transmit</b>					
<i>Timing Requirements:</i>					
t <sub>SLACH</sub>	LACK Setup Before LCLK High		19	19	ns
t <sub>HLACH</sub>	LACK Hold After LCLK High		-6.75	-6.5	ns
<i>Switching Characteristics:</i>					
t <sub>DLCLK</sub>	LCLK Delay After CLKIN		8.5	8.5	ns
t <sub>DLDCH</sub>	Data Delay After LCLK High		3	2.75	ns
t <sub>HLDC</sub>	Data Hold After LCLK High		-2	-2	ns
t <sub>LCLKTWL</sub>	LCLK Width Low		(t <sub>CK</sub> /4) - 1	(t <sub>CK</sub> /4) + 1	ns
t <sub>LCLKTWH</sub>	LCLK Width High		(t <sub>CK</sub> /4) - 1	(t <sub>CK</sub> /4) + 1	ns
t <sub>DLACLK</sub>	LCLK Low Delay After LACK High		(t <sub>CK</sub> /4) + 9	(3 × t <sub>CK</sub> /4) + 17	ns

**NOTE**

<sup>1</sup>LACK will go low with t<sub>DLALC</sub> relative to rising edge of LCLK after first nibble is received. LACK will not go low if the receiver's link buffer is not about to fill.

# AD14160/AD14160L

## TRANSMIT

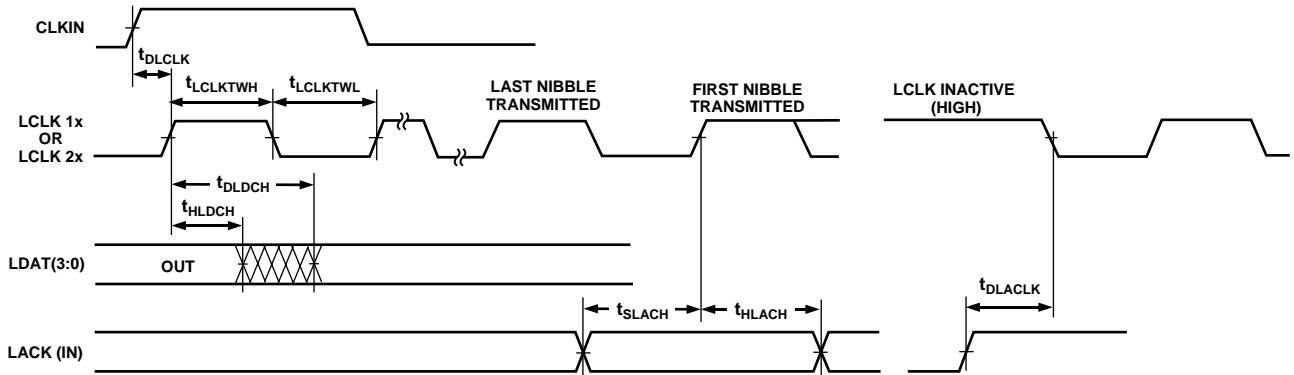

THE  $t_{SLACH}$  REQUIREMENT APPLIES TO THE RISING EDGE OF LCLK ONLY FOR THE FIRST NIBBLE TRANSMITTED.

## RECEIVE

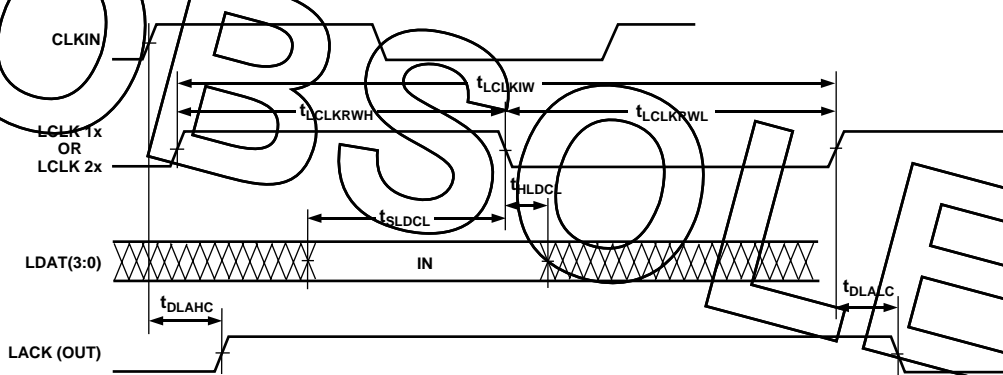

LACK GOES LOW ONLY AFTER THE SECOND NIBBLE IS RECEIVED.

## LINK PORT ENABLE/THREE-STATE DELAY FROM INSTRUCTION

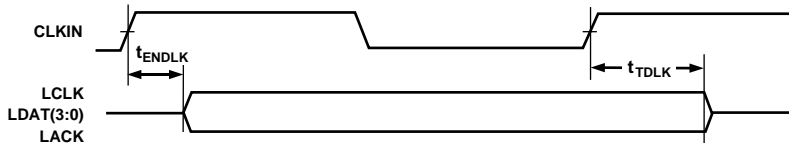

LINK PORT ENABLE OR THREE-STATE TAKES EFFECT 2 CYCLES AFTER A WRITE TO A LINK PORT CONTROL REGISTER.

## LINK PORT INTERRUPT SETUP TIME

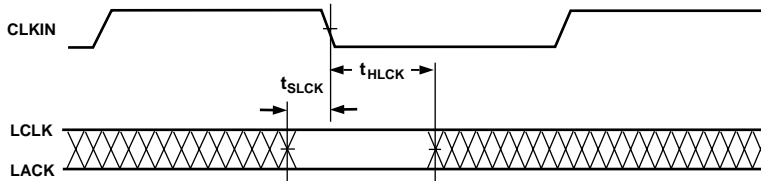

Figure 22. Link Ports



## Serial Ports

Parameter	40 MHz–5 V		40 MHz–3.3 V		Units		
	Min	Max	Min	Max			
<b>External Clock</b>							
<i>Timing Requirements:</i>							
t <sub>SFSE</sub>	TFS/RFS Setup Before TCLK/RCLK <sup>1</sup>		3.5		ns		
t <sub>HFSE</sub>	TFS/RFS Hold After TCLK/RCLK <sup>1,2</sup>		4		ns		
t <sub>SDRE</sub>	Receive Data Setup Before RCLK <sup>1</sup>		1.5		ns		
t <sub>HDRE</sub>	Receive Data Hold After RCLK <sup>1</sup>		4		ns		
t <sub>SCLKW</sub>	TCLK/RCLK Width		9.5		ns		
t <sub>SCLK</sub>	TCLK/RCLK Period		t <sub>CK</sub>		ns		
<b>Internal Clock</b>							
<i>Timing Requirements:</i>							
t <sub>SFSI</sub>	TFS Setup Before TCLK <sup>1</sup> ; RFS Setup Before RCLK <sup>1</sup>		8		ns		
t <sub>HFSI</sub>	TFS/RFS Hold After TCLK/RCLK <sup>1,2</sup>		1		ns		
t <sub>SDRI</sub>	Receive Data Setup Before RCLK <sup>1</sup>		3		ns		
t <sub>HDRI</sub>	Receive Data Hold After RCLK <sup>1</sup>		3		ns		
<b>External or Internal Clock</b>							
<i>Switching Characteristics:</i>							
t <sub>DFSE</sub>	RFS Delay After RCLK (Internally Generated RFS) <sup>3</sup>		13.5		ns		
t <sub>HFSE</sub>	RFS Hold After RCLK (Internally Generated RFS) <sup>3</sup>		3		ns		
<b>External Clock</b>							
<i>Switching Characteristics:</i>							
t <sub>DFSE</sub>	TFS Delay After TCLK (Internally Generated TFS) <sup>3</sup>		13.5		ns		
t <sub>HFSE</sub>	TFS Hold After TCLK (Internally Generated TFS) <sup>3</sup>		3		ns		
t <sub>DDTE</sub>	Transmit Data Delay After TCLK <sup>3</sup>		16.5		ns		
t <sub>HDTE</sub>	Transmit Data Hold After TCLK <sup>3</sup>		5		ns		
<b>Internal Clock</b>							
<i>Switching Characteristics:</i>							
t <sub>DFSI</sub>	TFS Delay After TCLK (Internally Generated TFS) <sup>3</sup>		4.5		ns		
t <sub>HFSI</sub>	TFS Hold After TCLK (Internally Generated TFS) <sup>3</sup>		-1.5		ns		
t <sub>DDTI</sub>	Transmit Data Delay After TCLK <sup>3</sup>		7.5		ns		
t <sub>HDTI</sub>	Transmit Data Hold After TCLK <sup>3</sup>		0		ns		
t <sub>SCLKIW</sub>	TCLK/RCLK Width		(SCLK/2) – 2	(SCLK/2) + 2	(SCLK/2) – 2.5	(SCLK/2) + 2.5	ns
<b>Enable and Three-State</b>							
<i>Switching Characteristics:</i>							
t <sub>DDTEN</sub>	Data Enable from External TCLK <sup>3</sup>		3.5		ns		
t <sub>DDTTE</sub>	Data Disable from External TCLK <sup>3</sup>			11		ns	
t <sub>DDTIN</sub>	Data Enable from Internal TCLK <sup>3</sup>		0		ns		
t <sub>DDTTI</sub>	Data Disable from Internal TCLK <sup>3</sup>			3		ns	
t <sub>DCLK</sub>	TCLK/RCLK Delay from CLKIN			22.5 + 3DT/8		ns	
t <sub>DPTR</sub>	SPORT Disable After CLKIN			17.5		ns	
<b>External Late Frame Sync</b>							
<i>Switching Characteristics:</i>							
t <sub>DDTLFSE</sub>	Data Delay from Late External TFS or External RFS with MCE = 1, MFD = 0 <sup>4</sup>			12.5		ns	
t <sub>DDTENFS</sub>	Data Enable from Late FS or MCE = 1, MFD = 0 <sup>4</sup>		3		3.5	ns	

To determine whether communication is possible between two devices at clock speed *n*, the following specifications must be confirmed: 1) frame sync delay and frame sync setup and hold, 2) data delay and data setup and hold, and 3) SCLK width.

### NOTES

<sup>1</sup>Referenced to sample edge.

<sup>2</sup>RFS hold after RCLK when MCE = 1, MFD = 0 is 0 ns minimum from drive edge. TFS hold after TCLK for late external TFS is 0 ns minimum from drive edge.

<sup>3</sup>Referenced to drive edge.

<sup>4</sup>MCE = 1, TFS enable and TFS valid follow t<sub>DDTLFSE</sub> and t<sub>DDTENFS</sub>.

EXTERNAL RFS with MCE = 1, MFD = 0

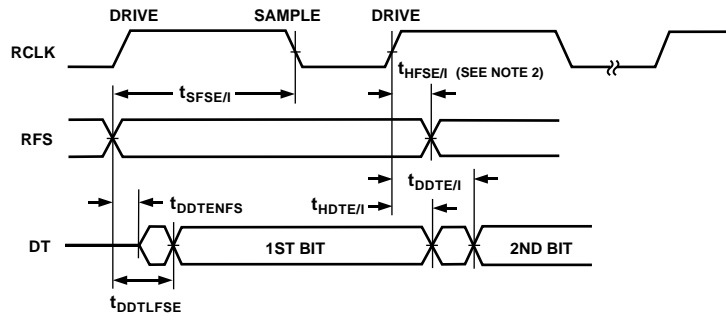

LATE EXTERNAL TFS

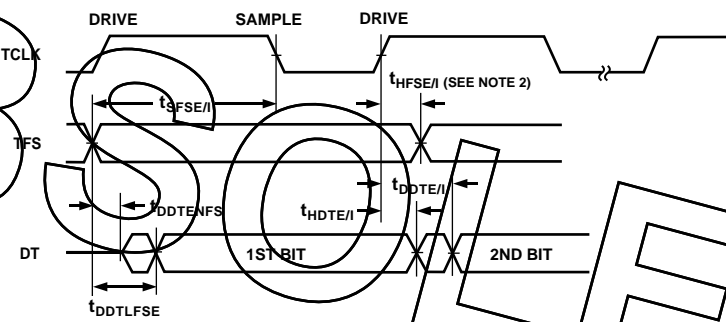
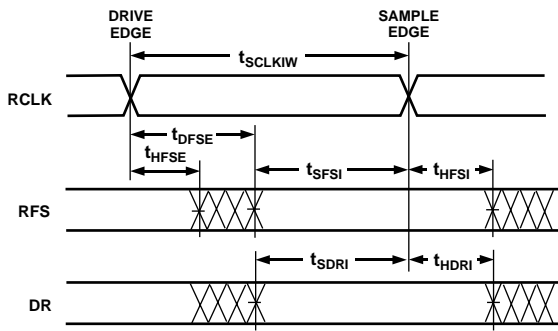

Figure 23. External Late Frame Sync

OBSOLETE

DATA RECEIVE- INTERNAL CLOCK



DATA RECEIVE- EXTERNAL CLOCK

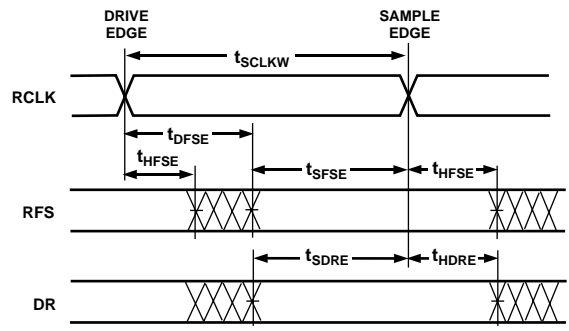

NOTE: EITHER THE RISING EDGE OR FALLING EDGE OF RCLK, TCLK CAN BE USED AS THE ACTIVE SAMPLING EDGE.

DATA TRANSMIT- INTERNAL CLOCK

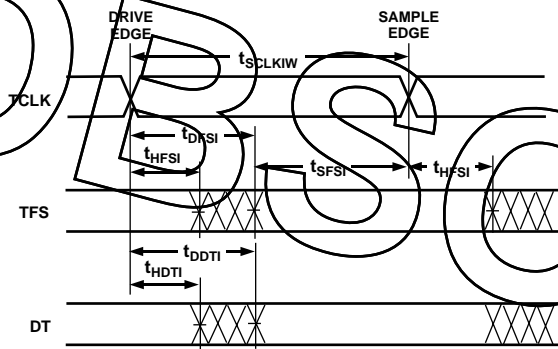

DATA TRANSMIT- EXTERNAL CLOCK

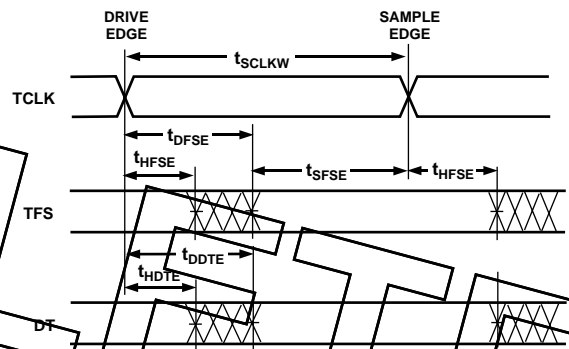

NOTE: EITHER THE RISING EDGE OR FALLING EDGE OF RCLK, TCLK CAN BE USED AS THE ACTIVE SAMPLING EDGE.

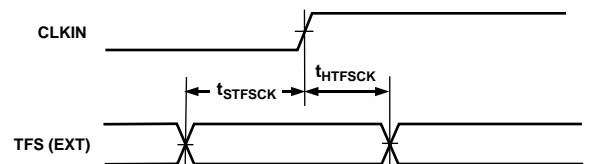
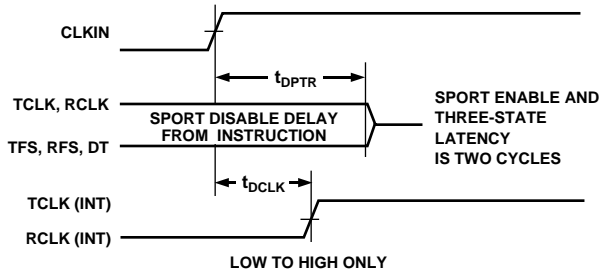
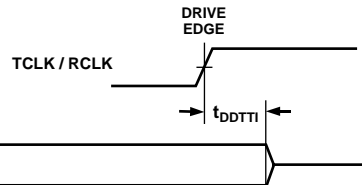
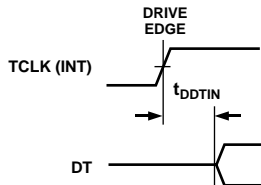
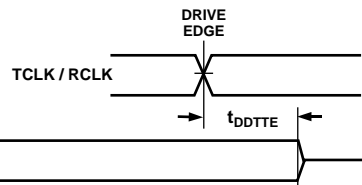
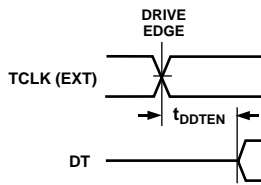

NOTE: APPLIES ONLY TO GATED SERIAL CLOCK MODE WITH EXTERNAL TFS, AS USED IN THE SERIAL PORT SYSTEM I/O FOR MESH MULTIPROCESSING.

Figure 24. Serial Ports

# AD14160/AD14160L

## JTAG Test Access Port and Emulation

Parameter	40 MHz–5 V		40 MHz–3.3 V		Units
	Min	Max	Min	Max	
<i>Timing Requirements:</i>					
$t_{TCK}$	TCK Period		$t_{CK}$		ns
$t_{STAP}$	TDI, TMS Setup Before TCK High		5.5		ns
$t_{HTAP}$	TDI, TMS Hold After TCK High		6.5		ns
$t_{SSYS}$	System Inputs Setup Before TCK Low <sup>1</sup>		8		ns
$t_{HSYS}$	System Inputs Hold After TCK Low <sup>1</sup>		18.5		ns
$t_{TRSTW}$	$\overline{TRST}$ Pulsewidth		$4t_{CK}$		ns
<i>Switching Characteristics:</i>					
$t_{DTDO}$	TDO Delay from TCK Low			13.5	ns
$t_{DSYS}$	System Outputs Delay After TCK Low <sup>2</sup>		20	20	ns

### NOTES

<sup>1</sup>System Inputs = DATA<sub>47-0</sub>, ADDR<sub>31-0</sub>,  $\overline{RD}$ ,  $\overline{WR}$ , ACK,  $\overline{SBTS}$ ,  $\overline{SW}$ ,  $\overline{HBR}$ ,  $\overline{HBG}$ ,  $\overline{CS}$ ,  $\overline{DMAR1}$ ,  $\overline{DMAR2}$ ,  $\overline{BR}_{6-1}$ , RPBA, ID<sub>y2-0</sub>,  $\overline{IRQ}_{2-0}$ , FLAG<sub>y3-0</sub>, DR<sub>y0</sub>, DyR1, TCLK<sub>y0</sub>, TCLK<sub>y1</sub>, RCLK<sub>y0</sub>, RCLK<sub>y1</sub>, TFS<sub>y0</sub>, TFS<sub>y1</sub>, RFS<sub>y0</sub>, RFS<sub>y1</sub>, LxDAT<sub>3-0</sub>, LxCLK, LxACK, EBOOT, LBOOT, BMS, CLKIN, RESET.

<sup>2</sup>System Outputs = DATA<sub>47-0</sub>, ADDR<sub>31-0</sub>, MS<sub>3-0</sub>,  $\overline{RD}$ ,  $\overline{WR}$ , ACK, PAGE, ADRCLK,  $\overline{SW}$ ,  $\overline{HBG}$ , REDY,  $\overline{DMAG1}$ ,  $\overline{DMAG2}$ ,  $\overline{BR}_{6-1}$ , CPA, FLAG<sub>2-0</sub>, TIMEXP, DT0, DT1, TCLK0, TCLK1, RCLK0, RCLK1, TFS0, TFS1, RFS0, RFS1, LxDAT<sub>3-0</sub>, LxCLK, LxACK, BMS.

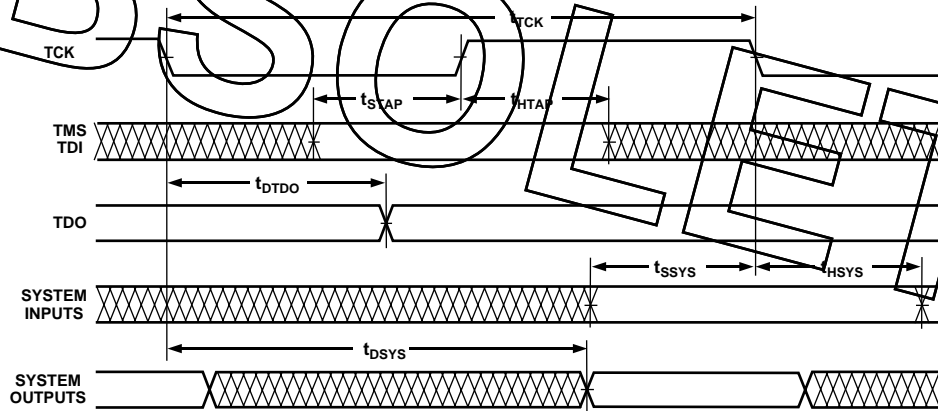

Figure 25. IEEE 11499.1 JTAG Test Access Port

## OUTPUT DRIVE CURRENTS

Figure 26 shows typical I-V characteristics for the output drivers of the ADSP-2106x. The curves represent the current drive capability of the output drivers as a function of output voltage.

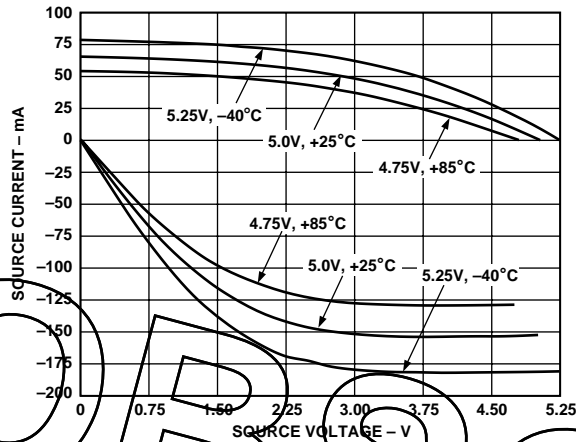

Figure 26. ADSP-2106x Typical Drive Currents ( $V_{DD} = 5 V$ )

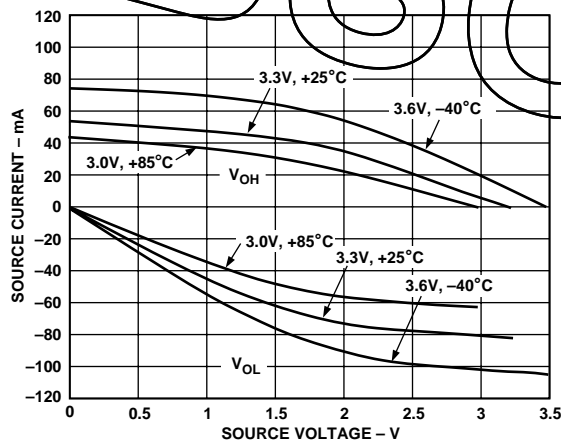

Figure 27. ADSP-2106x Typical Drive Currents ( $V_{DD} = 3.3 V$ )

## POWER DISSIPATION

Total power dissipation has two components, one due to internal circuitry and one due to the switching of external output drivers. Internal power dissipation is dependent on the instruction execution sequence and the data operands involved. Internal power dissipation is calculated in the following way:

$$P_{INT} = I_{DDIN} \times V_{DD}$$

The external component of total power dissipation is caused by the switching of output pins. Its magnitude depends on:

- the number of output pins that switch during each cycle ( $O$ )
- the maximum frequency at which they can switch ( $f$ )
- their load capacitance ( $C$ )
- their voltage swing ( $V_{DD}$ )

and is calculated by:

$$P_{EXT} = O \times C \times V_{DD}^2 \times f$$

The load capacitance should include the processor's package capacitance ( $C_{IN}$ ). The switching frequency includes driving the load high and then back low. Address and data pins can drive high and low at a maximum rate of  $1/(2t_{CK})$ . The write strobe can switch every cycle at a frequency of  $1/t_{CK}$ . Select pins switch at  $1/(2t_{CK})$ , but selects can switch on each cycle.

Example:

Estimate  $P_{EXT}$  with the following assumptions:

- A system with one bank of external data memory RAM (32-bit).
- Four 128K  $\times$  8 RAM chips are used, each with a load of 10 pF.
- External data memory writes occur every other cycle, a rate of  $1/(4t_{CK})$ , with 50% of the pins switching.
- The instruction cycle rate is 40 MHz ( $t_{CK} = 25$  ns) and  $V_{DD} = 3.3$  V.

The  $P_{EXT}$  equation is calculated for each class of pins that can drive:

Pin Type	# of Pins	% Switching	$\times C$	$\times$	$\times V_{DD}^2$	$= P_{EXT}$
Address	15	50	$\times 55$ pF	$\times 20$ MHz	$\times 10.9$ V	$= 0.089$ W
$\overline{MS0}$	1	0	$\times 55$ pF	$\times 20$ MHz	$\times 10.9$ V	$= 0.00$ W
$\overline{WR}$	1	-	$\times 55$ pF	$\times 40$ MHz	$\times 10.9$ V	$= 0.024$ W
Data	32	50	$\times 25$ pF	$\times 20$ MHz	$\times 10.9$ V	$= 0.087$ W
ADRCLK	1	-	$\times 15$ pF	$\times 40$ MHz	$\times 10.9$ V	$= 0.007$ W

$$P_{EXT} (3.3 V) = 0.207 \text{ W}$$

$$P_{EXT} (5 V) = 0.476 \text{ W}$$

A typical power consumption can now be calculated for these conditions by adding a typical internal power dissipation:

$$P_{TOTAL} = P_{EXT} + (I_{DDIN2} \times 5.0 V)$$

Note that the conditions causing a worst-case  $P_{EXT}$  are different from those causing a worst-case  $P_{INT}$ . Maximum  $P_{INT}$  cannot occur while 100% of the output pins are switching from all ones to all zeros. Also note that it is not common for an application to have 100% or even 50% of the outputs switching simultaneously.

# AD14160/AD14160L

## TEST CONDITIONS

### Output Disable Time

Output pins are considered to be disabled when they stop driving, go into a high impedance state, and start to decay from their output high or low voltage. The time for the voltage on the bus to decay by  $\Delta V$  is dependent on the capacitive load,  $C_L$ , and the load current,  $I_L$ . This decay time can be approximated by the following equation:

$$t_{DECAY} = \frac{C_L \Delta V}{I_L}$$

The output disable time,  $t_{DIS}$ , is the difference between  $t_{MEASURED}$  and  $t_{DECAY}$  as shown in Figure 28. The time  $t_{MEASURED}$  is the interval from when the reference signal switches to when the output voltage decays  $\Delta V$  from the measured output high or output low voltage.  $t_{DECAY}$  is calculated with test loads  $C_L$  and  $I_L$ , and with  $\Delta V$  equal to 0.5 V.

### Output Enable Time

Output pins are considered to be enabled when they have made a transition from a high impedance state to when they start driving. The output enable time,  $t_{ENA}$ , is the interval from when a reference signal reaches a high or low voltage level to when the output has reached a specified high or low trip point, as shown in the Output Enable/Disable diagram (Figure 28). If multiple pins (such as the data bus) are enabled, the measurement value is that of the first pin to start driving.

### Example System Hold Time Calculation

To determine the data output hold time in a particular system, first calculate  $t_{DECAY}$  using the equation given above. Choose  $\Delta V$  to be the difference between the ADSP-2106x's output voltage and the input threshold for the device requiring the hold time. A typical  $\Delta V$  will be 0.4 V.  $C_L$  is the total bus capacitance (per data line), and  $I_L$  is the total leakage or three-state current (per data line). The hold time will be  $t_{DECAY}$  plus the minimum disable time (i.e.,  $t_{HDWD}$  for the write cycle).

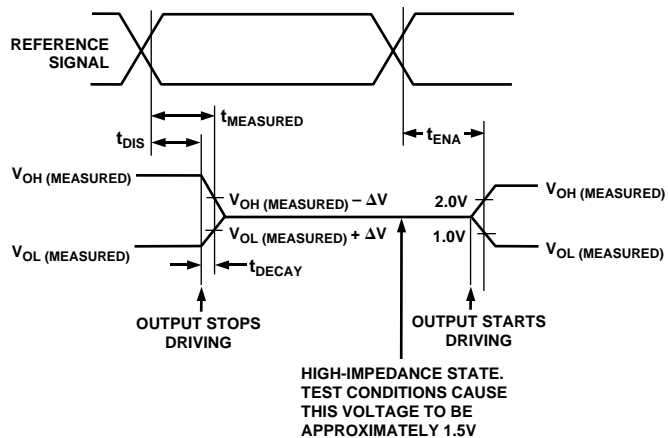

Figure 28. Output Enable/Disable

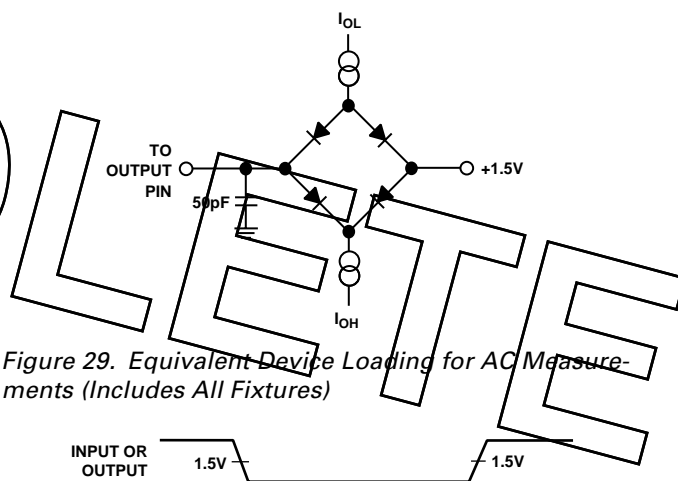

Figure 29. Equivalent Device Loading for AC Measurements (Includes All Fixtures)

Figure 30. Voltage Reference Levels for AC Measurements (Except Output Enable/Disable)

### Capacitive Loading

Output delays and holds are based on standard capacitive loads: 50 pF on all pins (see Figure 29). The delay and hold specifications given should be derated by a factor of 1.5 ns/50 pF for loads other than the nominal value of 50 pF. Figures 31, 32, 33 and 34 show how output rise time varies with capacitance. Figures 35 and 36 graphically show how output delays and holds vary with load capacitance. (Note that these graphs or derating does not apply to output disable delays; see the previous section Output Disable Time under Test Conditions.) The graphs of Figures 31 through 36 may not be linear outside the ranges shown.

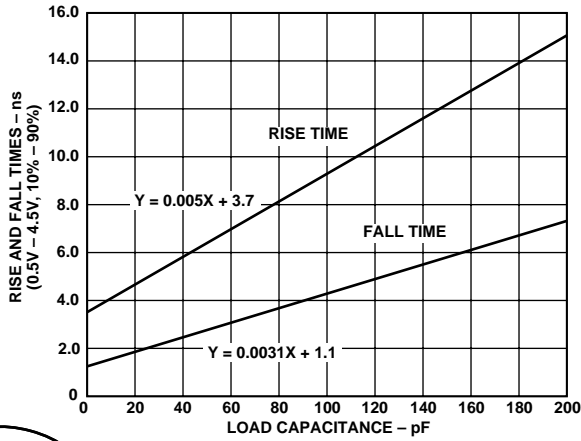

Figure 31. Typical Output Rise Time (10%–90%) vs. Load Capacitance ( $V_{DD} = 5\text{ V}$ )

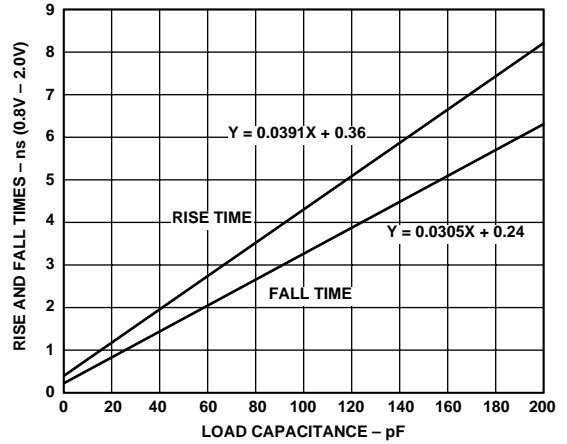

Figure 34. Typical Output Rise Time (0.8 V–2.0 V) vs. Load Capacitance ( $V_{DD} = 3.3\text{ V}$ )

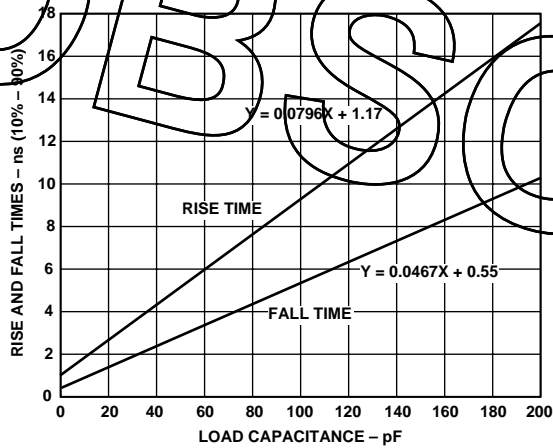

Figure 32. Typical Output Rise Time (10%–90%) vs. Load Capacitance ( $V_{DD} = 3.3\text{ V}$ )

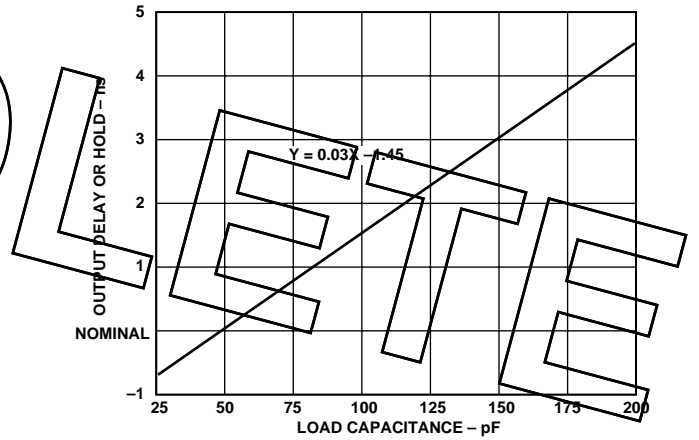

Figure 35. Typical Output Delay or Hold vs. Load Capacitance (at Maximum Case Temperature) ( $V_{DD} = 5\text{ V}$ )

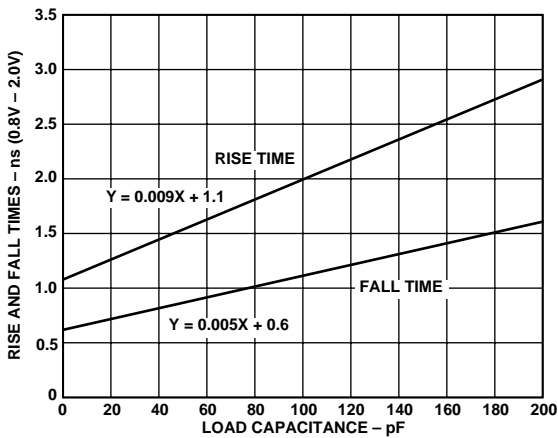

Figure 33. Typical Output Rise Time (0.8 V–2.0 V) vs. Load Capacitance ( $V_{DD} = 5\text{ V}$ )

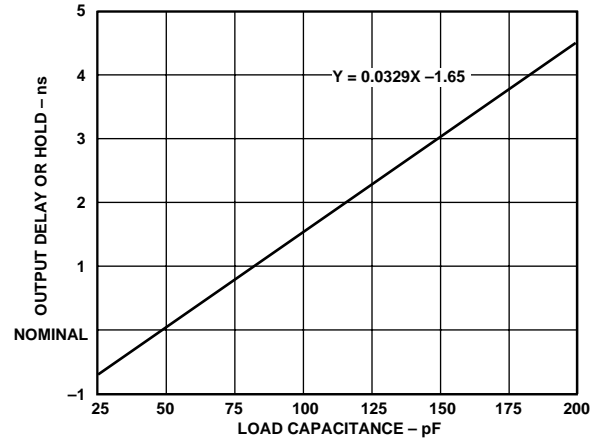

Figure 36. Typical Output Delay or Hold vs. Load Capacitance (at Maximum Case Temperature) ( $V_{DD} = 3.3\text{ V}$ )

# AD14160/AD14160L

## ASSEMBLY RECOMMENDATIONS

### Socket Information

Standard sockets are available from 3M and Plastronics. The 3M socket used is the BGA III style. The customer must specify how they want the socket populated with pins and a slight modification is required to compensate for the tolerance of the package thickness.

### PCB Board Layout

A classical dog bone style pad should be used. A solder pad diameter of 0.65 mm is recommended. The pad should be non-soldermask defined.

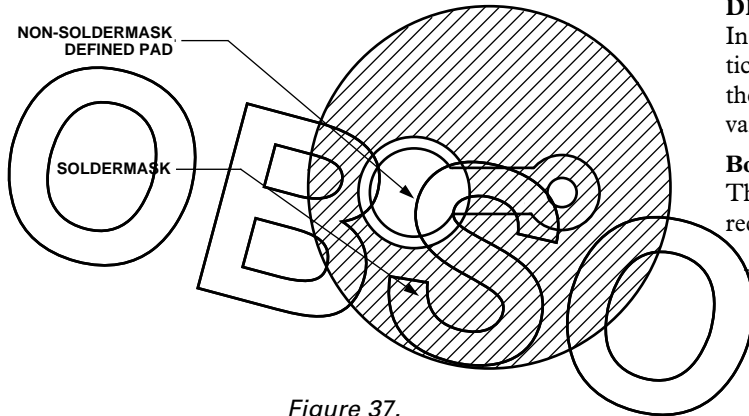

Figure 37.

### Solder Paste Printing

A solder paste print of 0.7 mm diameter with thickness of 0.15 to 0.2 mm is recommended. Normal solder paste alloy can be used, i.e., 60/40, 63/37, etc.

### Reflow Profile

The profile shown below is recommended.

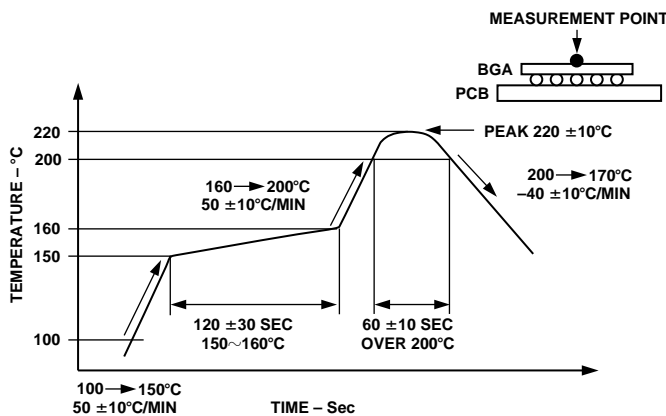

Figure 38.

### Signal Pad Assignment Topology

The AD14160/AD14160L signal pad assignments were carefully analyzed for improved board routing and maximum reliability. By restricting the required 432 I/O to the inner 25 mm circle, TCE mismatch concerns are minimized. (BGA ball patterns of 25 mm size are well characterized and documented.) The signal I/O is carefully placed and grouped to minimize pin escape difficulties in routing. Redundant power/ground contact pads are also provided (but not required) to improve the thermal performance and the ground bounce performance of the package (see Figure 42).

### DENSITY IMPROVEMENTS

In addition to careful considerations to performance characteristics such as ground bounce, signal quality, and noise isolation, the AD14160/AD14160L also provides significant density advantages.

### Board Area Reduction

The minimally packaged AD14160/AD14160L CBGA reduces required board area by approximately 75%.

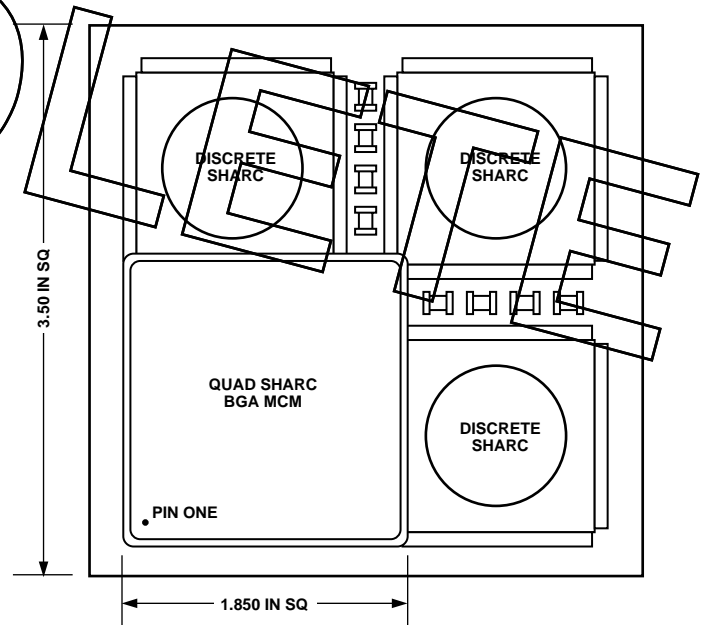

Figure 39.

### Embedded Wiring

Forty feet of optimized routing is embedded in four integrated signal routing layers (in addition to power and ground planes). This eliminated hundreds of feet of multiprocessing interconnect on the target PCB; thereby, also reducing board cost and required routing layers.



## GROUND BOUNCE ESTIMATE

Ground bounce diminishes noise margins in a system and must be held as low as possible. Ground bounce results from switching output pins from a high to a low state with the ensuing discharge current creating a voltage across the parasitic inductance of the MCM's ground pins (and to a lesser extent across the wirebond wires connecting the ground pads). A useful model for calculating the level of ground bounce is shown below (Johnson, Howard W. and Graham, Martin, "High-Speed Digital Design," Prentice Hall p67, 1993).

In the Quad-SHARC module, the worst case ground bounce condition occurs during an external memory operation in which 86 signals switch simultaneously from high to low. Because of the ground planes embedded within the substrate of the module, the effective ground pin inductance is found by dividing the CBGA's single ground pin inductance, estimated to be about 3 nH, by the 64 ground pins resulting in  $L_{GND} = 0.05$  nH. Typical output fall times for varying load conditions can be obtained from this data sheet.

The induced voltage generated by the switching currents is given by

$$V_{GND} = L_{GND} \frac{d}{dt} (I_{DISCHARGE})$$

Assuming the voltage waveform is an integrated Gaussian pulse, the peak amplitude is approximated by

$$|V_{GND}|_{max} = L_{GND} \frac{1.52\Delta V}{T_{10-90}^2} C.$$

Calculated ground bounce maximum values for the CBGA module are listed below.

Load per Output (pF)	Fall Time (ns)	Ground Bounce (V)
20	1.8	0.161
100	4.2	0.148
200	7.4	0.095

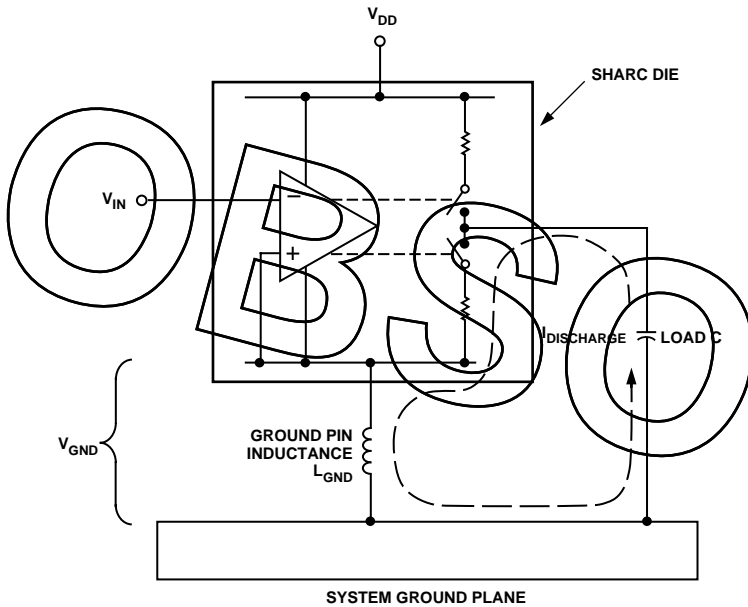

Figure 40.

# AD14160/AD14160L

## Thermal Characteristics

The AD14160/AD14160L is packaged in a 452-lead ceramic ball grid array (CBGA). The package is optimized for thermal conduction through the core (base of the package) down to the mounting surface. The AD14160/AD14160L is specified for a case temperature ( $T_{CASE}$ ). Design of the mounting surface and attachment material should be such that  $T_{CASE}$  is not exceeded.

$$\theta_{JC} = 0.36^{\circ}C/W$$

## Thermal Cross-Section

The data below, together with the detailed mechanical drawings at the end of the data sheet, allows for constructing simple thermal models for further analysis within targeted systems. The top layer of the package, where the die are mounted, is a metal  $V_{DD}$  layer. The approximate metal area coverage from the metal planes and routing layers is estimated below.

Metal Coverage Per Layer

Layer	Percent Metal (1 Mil Thick)
$V_{DD}$	87
SIG2	12
SIG3	12
GND	89
SIG4	14
SIG5	13
BASE	91

(Assume Uniformly Distributed)

Material	Thermal Conductivity $W/cm^{\circ}C$
Ceramic	0.18
Kovar	0.14
Tungsten	1.78
Thermoplastic	0.03
Silicon	1.45

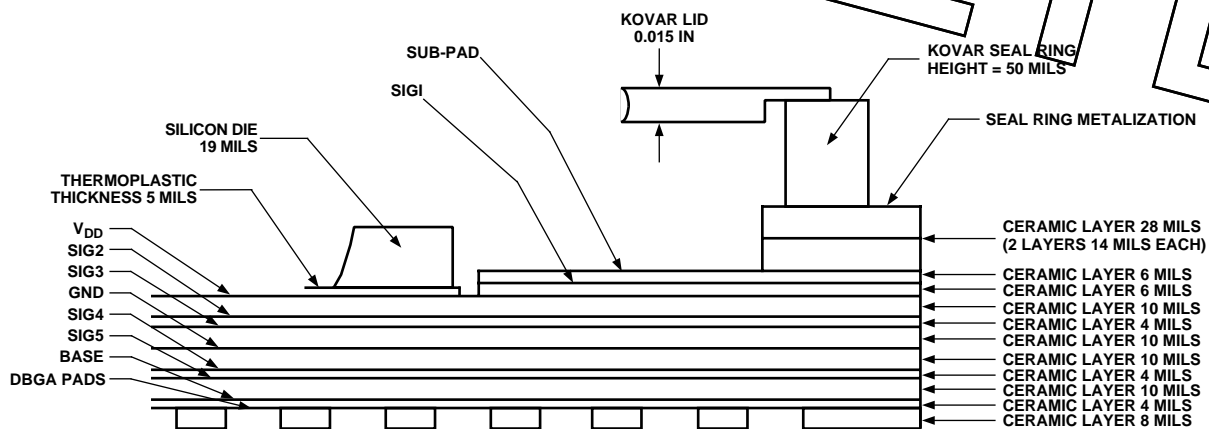

Figure 41.

# AD14160/AD14160L

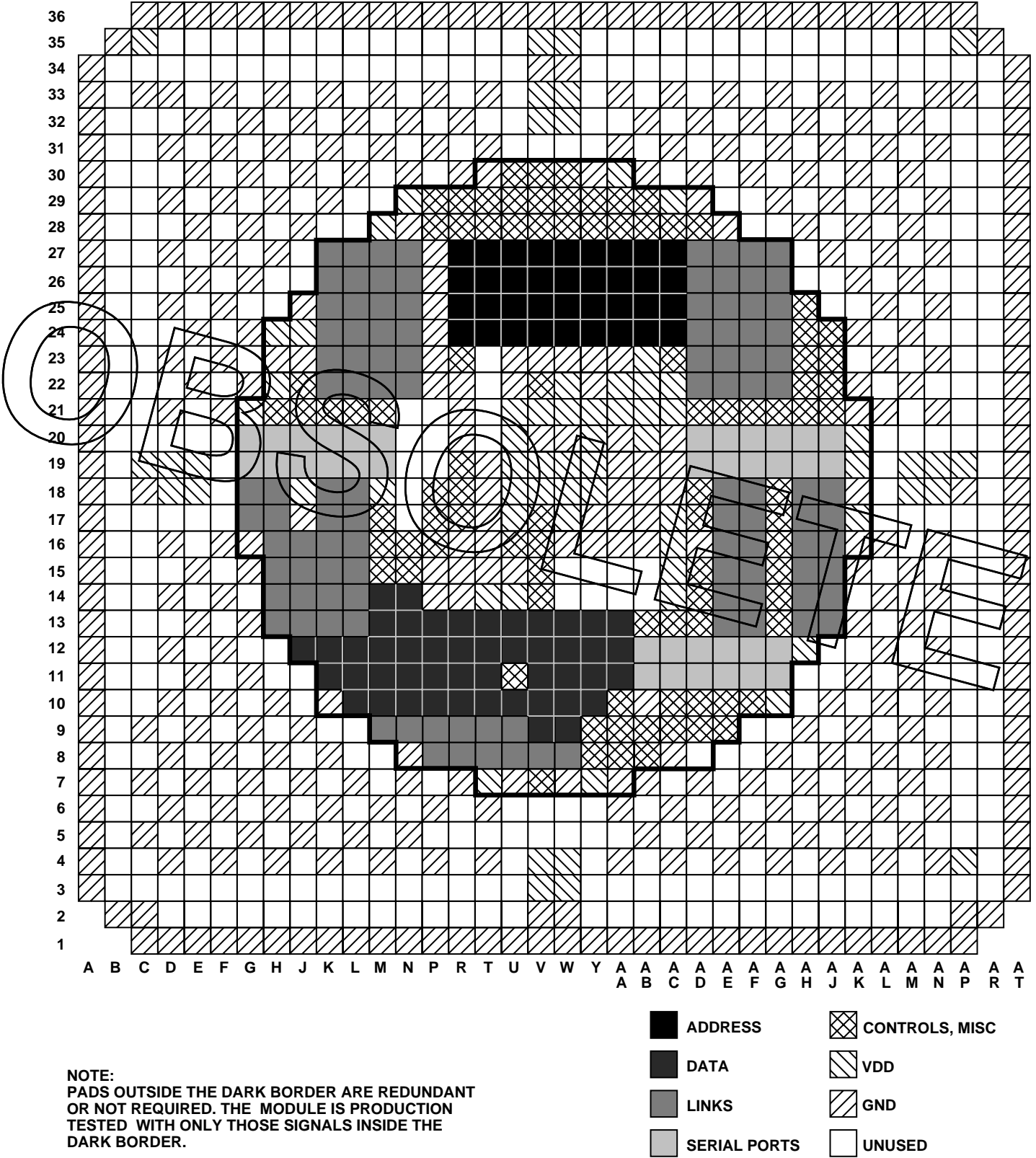

Figure 42. Board Footprint for AD14160/AD14160L Quad SHARC BGA

# AD14160/AD14160L

## MECHANICAL CHARACTERISTICS

### Lid Deflection Analysis

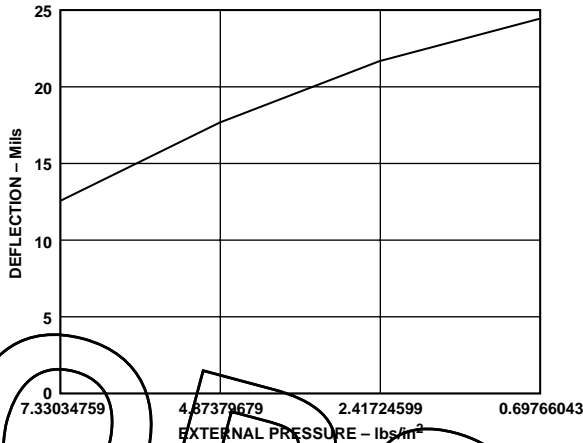

Figure 43. Deflection (mils) vs. External Pressure

### Mechanical Model

The data below, together with the detailed mechanical drawings at the end of the data sheet, allows for construction of simple mechanical models for further analysis within targeted systems.

### Mechanical Properties

Material	Modulus of Elasticity
Ceramic	$26 \times 10^3 \text{ kg/mm}^2$
Kovar	$14.1 \times 10^3 \text{ kg/mm}^2$
Tungsten	$35 \times 10^3 \text{ kg/mm}^2$
Thermoplastic	$279 \text{ kg/mm}^2$
Silicon	$11 \times 10^3 \text{ kg/mm}^2$

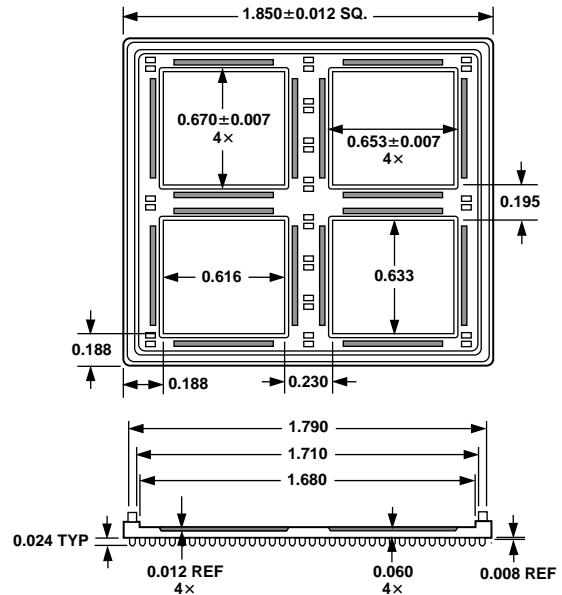

The following pages list two separate pin listings. The first is ordered by pin number and the second is an alphabetical list by pin name. Note that there are many not required or redundant pins beyond the standard package 452 leads. These pins are noted in parentheses. For example: (GND), (VDD), (unused), (TEST). These pins are extraneous and only the redundant (GND) and (VDD) should be connected if desired.

### 452-LEAD CBGA PIN CONFIGURATION

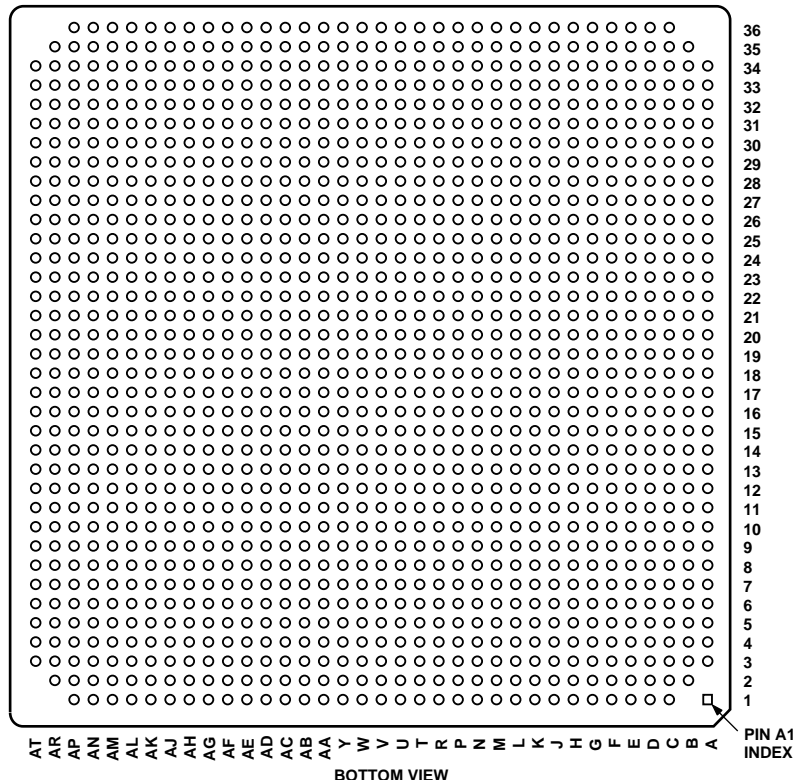

## PIN CONFIGURATIONS (Pin Order Listing)

Pin No	Pin Name	Pin No	Pin Name	Pin No.	Pin Name	Pin No	Pin Name	Pin No.	Pin Name	Pin No.	Pin Name
		C1	(GND)	E1	(GND)	G1	(GND)	J1	(GND)	L1	(GND)
		C2	(GND)	E2	(unused)	G2	(unused)	J2	(unused)	L2	(unused)
A3	(GND)	C3	(unused)	E3	(unused)	G3	(unused)	J3	(unused)	L3	(unused)
A4	(GND)	C4	(VDD)	E4	(unused)	G4	(unused)	J4	(unused)	L4	(unused)
A5	(GND)	C5	(unused)	E5	(GND)	G5	(GND)	J5	(GND)	L5	(GND)
A6	(GND)	C6	(unused)	E6	(unused)	G6	(unused)	J6	(unused)	L6	(unused)
A7	(GND)	C7	(unused)	E7	(GND)	G7	(GND)	J7	(GND)	L7	(GND)
A8	(GND)	C8	(unused)	E8	(unused)	G8	(unused)	J8	(unused)	L8	(unused)
A9	(GND)	C9	(unused)	E9	(GND)	G9	(GND)	J9	(GND)	L9	(TEST10)
A10	(GND)	C10	(unused)	E10	(unused)	G10	(unused)	J10	(unused)	L10	DATA30
A11	(GND)	C11	(unused)	E11	(GND)	G11	(GND)	J11	(TEST11)	L11	DATA22
A12	(GND)	C12	(unused)	E12	(unused)	G12	(unused)	J12	DATA10	L12	DATA12
A13	(GND)	C13	(unused)	E13	(GND)	G13	(GND)	J13	LB2ACK	L13	LB4ACK
A14	(GND)	C14	(unused)	E14	(unused)	G14	(unused)	J14	LB2CLK	L14	LB4CLK
A15	(GND)	C15	(unused)	E15	(GND)	G15	(GND)	J15	LB2DAT0	L15	LB4DAT0
A16	(GND)	C16	(unused)	E16	(unused)	G16	GND	J16	LB2DAT1	L16	LB4DAT1
A17	(GND)	C17	(unused)	E17	(unused)	G17	LB1DAT2	J17	GND	L17	LB4DAT2
A18	(GND)	C18	(GND)	E18	(VDD)	G18	LB1DAT3	J18	VDD	L18	LB4DAT3
A19	(GND)	C19	(VDD)	E19	(VDD)	G19	RFSA1	J19	DRA1	L19	TCLKA1
A20	(GND)	C20	(unused)	E20	(unused)	G20	RFSA0	J20	DRA0	L20	TCLKA0
A21	(GND)	C21	(unused)	E21	(unused)	G21	VDD	J21	ACK	L21	RESET
A22	(GND)	C22	(unused)	E22	(GND)	G22	(GND)	J22	PAGE	L22	LA2ACK
A23	(GND)	C23	(unused)	E23	(unused)	G23	(unused)	J23	GND	L23	LA2CLK
A24	(GND)	C24	(unused)	E24	(GND)	G24	(GND)	J24	VDD	L24	LA2DAT0
A25	(GND)	C25	(unused)	E25	(unused)	G25	(unused)	J25	GND	L25	LA2DAT1
A26	(GND)	C26	(unused)	E26	(GND)	G26	(GND)	J26	(TEST14)	L26	LA2DAT2
A27	(GND)	C27	(unused)	E27	(unused)	G27	(unused)	J27	(unused)	L27	LA2DAT3
A28	(GND)	C28	(unused)	E28	(GND)	G28	(GND)	J28	(GND)	L28	(TEST15)
A29	(GND)	C29	(unused)	E29	(unused)	G29	(unused)	J29	(unused)	L29	(unused)
A30	(GND)	C30	(unused)	E30	(GND)	G30	(GND)	J30	(GND)	L30	(GND)
A31	(GND)	C31	(unused)	E31	(unused)	G31	(unused)	J31	(unused)	L31	(unused)
A32	(GND)	C32	(unused)	E32	(GND)	G32	(GND)	J32	(GND)	L32	(GND)
A33	(GND)	C33	(GND)	E33	(unused)	G33	(unused)	J33	(unused)	L33	(unused)
A34	(GND)	C34	(unused)	E34	(unused)	G34	(unused)	J34	(unused)	L34	(unused)
		C35	(VDD)	E35	(unused)	G35	(unused)	J35	(unused)	L35	(unused)
		C36	(GND)	E36	(GND)	G36	(GND)	J36	(GND)	L36	(GND)
B2	(GND)	D1	(GND)	F1	(GND)	H1	(GND)	K1	(GND)	M1	(GND)
B3	(unused)	D2	(unused)	F2	(unused)	H2	(unused)	K2	(unused)	M2	(unused)
B4	(unused)	D3	(unused)	F3	(unused)	H3	(unused)	K3	(unused)	M3	(unused)
B5	(unused)	D4	(GND)	F4	(GND)	H4	(GND)	K4	(GND)	M4	(GND)
B6	(unused)	D5	(unused)	F5	(unused)	H5	(unused)	K5	(unused)	M5	(unused)
B7	(unused)	D6	(GND)	F6	(GND)	H6	(GND)	K6	(GND)	M6	(GND)
B8	(unused)	D7	(unused)	F7	(unused)	H7	(unused)	K7	(unused)	M7	(unused)
B9	(unused)	D8	(GND)	F8	(GND)	H8	(GND)	K8	(GND)	M8	(TEST10)
B10	(unused)	D9	(unused)	F9	(unused)	H9	(unused)	K9	(unused)	M9	RFSB0
B11	(unused)	D10	(GND)	F10	(GND)	H10	(GND)	K10	GND	M10	DATA31
B12	(unused)	D11	(unused)	F11	(unused)	H11	(unused)	K11	DATA21	M11	DATA23
B13	(unused)	D12	(GND)	F12	(GND)	H12	(TEST11)	K12	DATA11	M12	DATA13
B14	(unused)	D13	(unused)	F13	(unused)	H13	LB1ACK	K13	LB3ACK	M13	DATA2
B15	(unused)	D14	(GND)	F14	(GND)	H14	LB1CLK	K14	LB3CLK	M14	DATA0
B16	(unused)	D15	(unused)	F15	(unused)	H15	LB1DAT0	K15	LB3DAT0	M15	DMAG1
B17	(unused)	D16	(GND)	F16	(GND)	H16	LB1DAT1	K16	LB3DAT1	M16	DMARI
B18	(unused)	D17	(unused)	F17	(TEST12)	H17	LB2DAT2	K17	LB3DAT2	M17	DMAR2
B19	(unused)	D18	(VDD)	F18	(TEST12)	H18	LB2DAT3	K18	LB3DAT3	M18	VDD
B20	(unused)	D19	(VDD)	F19	(TEST13)	H19	RCLKA1	K19	TFSA1	M19	DTA1
B21	(unused)	D20	(unused)	F20	(TEST13)	H20	RCLKA0	K20	TFSA0	M20	DTA0
B22	(unused)	D21	(GND)	F21	(GND)	H21	REDY	K21	CSA	M21	CPAA
B23	(unused)	D22	(unused)	F22	(unused)	H22	VDD	K22	LA1ACK	M22	LA3ACK
B24	(unused)	D23	(GND)	F23	(GND)	H23	GND	K23	LA1CLK	M23	LA3CLK
B25	(unused)	D24	(unused)	F24	(unused)	H24	VDD	K24	LA1DAT0	M24	LA3DAT0
B26	(unused)	D25	(GND)	F25	(GND)	H25	(TEST14)	K25	LA1DAT1	M25	LA3DAT1
B27	(unused)	D26	(unused)	F26	(unused)	H26	(unused)	K26	LA1DAT2	M26	LA3DAT2
B28	(unused)	D27	(GND)	F27	(GND)	H27	(GND)	K27	LA1DAT3	M27	LA3DAT3
B29	(unused)	D28	(unused)	F28	(unused)	H28	(unused)	K28	(unused)	M28	VDD
B30	(unused)	D29	(GND)	F29	(GND)	H29	(GND)	K29	(GND)	M29	(TEST15)
B31	(unused)	D30	(unused)	F30	(unused)	H30	(unused)	K30	(unused)	M30	(unused)
B32	(unused)	D31	(GND)	F31	(GND)	H31	(GND)	K31	(GND)	M31	(GND)
B33	(unused)	D32	(unused)	F32	(unused)	H32	(unused)	K32	(unused)	M32	(unused)
B34	(unused)	D33	(GND)	F33	(GND)	H33	(GND)	K33	(GND)	M33	(GND)
B35	(GND)	D34	(unused)	F34	(unused)	H34	(unused)	K34	(unused)	M34	(unused)
		D35	(unused)	F35	(unused)	H35	(unused)	K35	(unused)	M35	(unused)
		D36	(GND)	F36	(GND)	H36	(GND)	K36	(GND)	M36	(GND)

# AD14160/AD14160L

## PIN CONFIGURATIONS (Pin Order Listing *Continued*)

Pin No	Pin Name	Pin No	Pin Name	Pin No.	Pin Name	Pin No	Pin Name	Pin No.	Pin Name	Pin No.	Pin Name
N1	(GND)	R1	(GND)	U1	(GND)	W1	(GND)	AA1	(GND)	AC1	(GND)
N2	(unused)	R2	(unused)	U2	(unused)	W2	(GND)	AA2	(unused)	AC2	(unused)
N3	(unused)	R3	(unused)	U3	(unused)	W3	(VDD)	AA3	(unused)	AC3	(unused)
N4	(unused)	R4	(unused)	U4	(unused)	W4	(VDD)	AA4	(GND)	AC4	(GND)
N5	(GND)	R5	(GND)	U5	(unused)	W5	(VDD)	AA5	(unused)	AC5	(unused)
N6	(unused)	R6	(unused)	U6	(TEST9)	W6	(TEST8)	AA6	(GND)	AC6	(GND)
N7	(GND)	R7	(GND)	U7	GND	W7	GND	AA7	GND	AC7	(unused)
N8	VDD	R8	RCLKB1	U8	TFSB1	W8	DTB1	AA8	HBR	AC8	GND
N9	RCLKB0	R9	TFSB0	U9	DTB0	W9	DATA46	AA9	BR2	AC9	BR4
N10	DATA32	R10	DATA34	U10	DATA36	W10	DATA38	AA10	CPAB	AC10	FLAGC0
N11	DATA24	R11	DATA26	U11	CLKIN	W11	DATA29	AA11	DATA44	AC11	RCLKC1
N12	DATA14	R12	DATA16	U12	DATA18	W12	DATA20	AA12	DATA42	AC12	RCLKC0
N13	DATA3	R13	DATA5	U13	DATA7	W13	DATA9	AA13	DATA40	AC13	ADRCLK
N14	DATA1	R14	GND	U14	VDD	W14	(unused)	AA14	(unused)	AC14	VDD
N15	DMAS2	R15	GND	U15	GND	W15	(unused)	AA15	(unused)	AC15	VDD
N16	SBYS	R16	GND	U16	TIMEXPB	W16	GND	AA16	GND	AC16	VDD
N17	(unused)	R17	IRQB0	U17	VDD	W17	VDD	AA17	GND	AC17	VDD
N18	(unused)	R18	IRQB1	U18	VDD	W18	VDD	AA18	GND	AC18	GND
N19	(unused)	R19	IRQB2	U19	VDD	W19	VDD	AA19	GND	AC19	GND
N20	(unused)	R20	GND	U20	VDD	W20	GND	AA20	GND	AC20	GND
N21	(unused)	R21	GND	U21	VDD	W21	VDD	AA21	VDD	AC21	VDD
N22	LA4ACK	R22	GND	U22	GND	W22	VDD	AA22	VDD	AC22	VDD
N23	LA4CLK	R23	RPBA	U23	GND	W23	GND	AA23	GND	AC23	TIMEXPC
N24	LA4DAT0	R24	MS0	U24	ADDR24	W24	ADDR16	AA24	ADDR8	AC24	ADDR0
N25	LA4DAT1	R25	MS1	U25	ADDR25	W25	ADDR17	AA25	ADDR9	AC25	ADDR1
N26	LA4DAT2	R26	MS2	U26	ADDR26	W26	ADDR18	AA26	ADDR10	AC26	ADDR2
N27	LA4DAT3	R27	MS3	U27	ADDR27	W27	ADDR19	AA27	ADDR11	AC27	ADDR3
N28	GND	R28	IDA0	U28	IRQA2	W28	FLAGA3	AA28	FLAGD1	AC28	FLAGD3
N29	VDD	R29	LBOOTA	U29	IRQA1	W29	FLAGA2	AA29	IRQD1	AC29	VDD
N30	(GND)	R30	(GND)	U30	TDOA	W30	TDI	AA30	VDD	AC30	(unused)
N31	(unused)	R31	(unused)	U31	(TEST16)	W31	(TEST1)	AA31	(GND)	AC31	(GND)
N32	(GND)	R32	(GND)	U32	(unused)	W32	(VDD)	AA32	(unused)	AC32	(unused)
N33	(unused)	R33	(unused)	U33	(unused)	W33	(VDD)	AA33	(GND)	AC33	(GND)
N34	(unused)	R34	(unused)	U34	(unused)	W34	(GND)	AA34	(unused)	AC34	(unused)
N35	(unused)	R35	(unused)	U35	(unused)	W35	(VDD)	AA35	(unused)	AC35	(unused)
N36	(GND)	R36	(GND)	U36	(GND)	W36	(GND)	AA36	(GND)	AC36	(GND)
P1	(GND)	T1	(GND)	V1	(GND)	Y1	(GND)	AB1	(GND)	AD1	(GND)
P2	(unused)	T2	(unused)	V2	(GND)	Y2	(unused)	AB2	(unused)	AD2	(unused)
P3	(unused)	T3	(unused)	V3	(VDD)	Y3	(unused)	AB3	(unused)	AD3	(unused)
P4	(GND)	T4	(GND)	V4	(VDD)	Y4	(unused)	AB4	(unused)	AD4	(unused)
P5	(unused)	T5	(unused)	V5	(VDD)	Y5	(unused)	AB5	(GND)	AD5	(GND)
P6	(GND)	T6	(GND)	V6	(TEST9)	Y6	(TEST8)	AB6	(unused)	AD6	(unused)
P7	(unused)	T7	VDD	V7	CSB	Y7	VDD	AB7	(GND)	AD7	(GND)
P8	RFSB1	T8	DRB1	V8	TCLKB1	Y8	SW	AB8	HGB	AD8	VDD
P9	DRB0	T9	TCLKB0	V9	DATA45	Y9	BR1	AB9	BR3	AD9	BR5
P10	DATA33	T10	DATA35	V10	DATA37	Y10	DATA47	AB10	GND	AD10	FLAGC1
P11	DATA25	T11	DATA27	V11	DATA28	Y11	DATA43	AB11	RFSC1	AD11	DRC1
P12	DATA15	T12	DATA17	V12	DATA19	Y12	DATA41	AB12	RFSC0	AD12	DRC0
P13	DATA4	T13	DATA6	V13	DATA8	Y13	DATA39	AB13	TDOB	AD13	CPAC
P14	GND	T14	VDD	V14	FLAGB0	Y14	(unused)	AB14	(unused)	AD14	CSC
P15	GND	T15	GND	V15	FLAGB1	Y15	(unused)	AB15	(unused)	AD15	EMU
P16	IDB0	T16	GND	V16	FLAGB2	Y16	GND	AB16	GND	AD16	GND
P17	IDB1	T17	GND	V17	FLAGB3	Y17	GND	AB17	GND	AD17	TMS
P18	IDB2	T18	GND	V18	VDD	Y18	VDD	AB18	GND	AD18	TRST
P19	(unused)	T19	GND	V19	VDD	Y19	VDD	AB19	GND	AD19	RFSD1
P20	(unused)	T20	(unused)	V20	GND	Y20	VDD	AB20	VDD	AD20	RFSD0
P21	(unused)	T21	(unused)	V21	VDD	Y21	VDD	AB21	VDD	AD21	BMSBCD
P22	GND	T22	(unused)	V22	BMSA	Y22	GND	AB22	VDD	AD22	LD1ACK
P23	GND	T23	(unused)	V23	GND	Y23	GND	AB23	VDD	AD23	LD1CLK
P24	GND	T24	ADDR28	V24	ADDR20	Y24	ADDR12	AB24	ADDR4	AD24	LD1DAT0
P25	GND	T25	ADDR29	V25	ADDR21	Y25	ADDR13	AB25	ADDR5	AD25	LD1DAT1
P26	GND	T26	ADDR30	V26	ADDR22	Y26	ADDR14	AB26	ADDR6	AD26	LD1DAT2
P27	GND	T27	ADDR31	V27	ADDR23	Y27	ADDR15	AB27	ADDR7	AD27	LD1DAT3
P28	IDA1	T28	IRQA0	V28	FLAGA0	Y28	FLAGD0	AB28	FLAGD2	AD28	TIMEXPD
P29	IDA2	T29	EBOOTA	V29	FLAGA1	Y29	IRQD0	AB29	IRQD2	AD29	GND
P30	(unused)	T30	GND	V30	TIMEXPA	Y30	GND	AB30	(GND)	AD30	(GND)
P31	(GND)	T31	(GND)	V31	(TEST16)	Y31	(TEST1)	AB31	(unused)	AD31	(unused)
P32	(unused)	T32	(unused)	V32	(VDD)	Y32	(unused)	AB32	(GND)	AD32	(GND)
P33	(GND)	T33	(GND)	V33	(VDD)	Y33	(unused)	AB33	(unused)	AD33	(unused)
P34	(unused)	T34	(unused)	V34	(GND)	Y34	(unused)	AB34	(unused)	AD34	(unused)
P35	(unused)	T35	(unused)	V35	(VDD)	Y35	(unused)	AB35	(unused)	AD35	(unused)
P36	(GND)	T36	(GND)	V36	(GND)	Y36	(GND)	AB36	(GND)	AD36	(GND)

## PIN CONFIGURATIONS (Pin Order Listing *Continued*)

Pin No	Pin Name	Pin No	Pin Name	Pin No.	Pin Name	Pin No	Pin Name	Pin No.	Pin Name	Pin No.	Pin Name
AE1	(GND)	AG1	(GND)	AJ1	(GND)	AL1	(GND)	AN1	(GND)	AR2	(GND)
AE2	(unused)	AG2	(unused)	AJ2	(unused)	AL2	(unused)	AN2	(unused)	AR3	(unused)
AE3	(unused)	AG3	(unused)	AJ3	(unused)	AL3	(unused)	AN3	(unused)	AR4	(unused)
AE4	(GND)	AG4	(GND)	AJ4	(GND)	AL4	(GND)	AN4	(GND)	AR5	(unused)
AE5	(unused)	AG5	(unused)	AJ5	(unused)	AL5	(unused)	AN5	(unused)	AR6	(unused)
AE6	(GND)	AG6	(GND)	AJ6	(GND)	AL6	(GND)	AN6	(GND)	AR7	(unused)
AE7	(unused)	AG7	(unused)	AJ7	(unused)	AL7	(unused)	AN7	(unused)	AR8	(unused)
AE8	(TEST7)	AG8	(GND)	AJ8	(GND)	AL8	(GND)	AN8	(GND)	AR9	(unused)
AE9	BR6	AG9	(unused)	AJ9	(unused)	AL9	(unused)	AN9	(unused)	AR10	(unused)
AE10	FLAGC2	AG10	GND	AJ10	(GND)	AL10	(GND)	AN10	(GND)	AR11	(unused)
AE11	TFSC1	AG11	DTC1	AJ11	(unused)	AL11	(unused)	AN11	(unused)	AR12	(unused)
AE12	TFSC0	AG12	DTC0	AJ12	(TEST6)	AL12	(GND)	AN12	(GND)	AR13	(unused)
AE13	LC1ACK	AG13	IRQC0	AJ13	LC4ACK	AL13	(unused)	AN13	(unused)	AR14	(unused)
AE14	LC1CLK	AG14	IRQC1	AJ14	LC4CLK	AL14	(GND)	AN14	(GND)	AR15	(unused)
AE15	LC1DAT0	AG15	IRQC2	AJ15	LC4DAT0	AL15	(unused)	AN15	(unused)	AR16	(unused)
AE16	LC1DAT1	AG16	IDC0	AJ16	LC4DAT1	AL16	(GND)	AN16	(GND)	AR17	(unused)
AE17	LC1DAT2	AG17	IDC1	AJ17	LC4DAT2	AL17	(TEST5)	AN17	(unused)	AR18	(unused)
AE18	LC1DAT3	AG18	IDC2	AJ18	LC4DAT3	AL18	(TEST5)	AN18	(VDD)	AR19	(unused)
AE19	RCLKD1	AG19	TFSD1	AJ19	DTD1	AL19	(TEST4)	AN19	(VDD)	AR20	(unused)
AE20	RCLKD0	AG20	TFSD0	AJ20	DTD0	AL20	(TEST4)	AN20	(unused)	AR21	(unused)
AE21	WR	AG21	CS0	AJ21	CPAD	AL21	(GND)	AN21	(GND)	AR22	(unused)
AE22	LD2ACK	AG22	LD4ACK	AJ22	TDO	AL22	(unused)	AN22	(unused)	AR23	(unused)
AE23	LD2CLK	AG23	LD4CLK	AJ23	ZBOOTBCD	AL23	(GND)	AN23	(GND)	AR24	(unused)
AE24	LD2DAT0	AG24	LD4DAT0	AJ24	TCK	AL24	(unused)	AN24	(unused)	AR25	(unused)
AE25	LD2DAT1	AG25	LD4DAT1	AJ25	(TEST3)	AL25	(GND)	AN25	(GND)	AR26	(unused)
AE26	LD2DAT2	AG26	LD4DAT2	AJ26	(unused)	AL26	(unused)	AN26	(unused)	AR27	(unused)
AE27	LD2DAT3	AG27	LD4DAT3	AJ27	(GND)	AL27	(GND)	AN27	(GND)	AR28	(unused)
AE28	VDD	AG28	(unused)	AJ28	(unused)	AL28	(unused)	AN28	(unused)	AR29	(unused)
AE29	(TEST2)	AG29	(GND)	AJ29	(GND)	AL29	(GND)	AN29	(GND)	AR30	(unused)
AE30	(unused)	AG30	(unused)	AJ30	(unused)	AL30	(unused)	AN30	(unused)	AR31	(unused)
AE31	(GND)	AG31	(GND)	AJ31	(GND)	AL31	(GND)	AN31	(GND)	AR32	(unused)
AE32	(unused)	AG32	(unused)	AJ32	(unused)	AL32	(unused)	AN32	(unused)	AR33	(unused)
AE33	(GND)	AG33	(GND)	AJ33	(GND)	AL33	(GND)	AN33	(GND)	AR34	(unused)
AE34	(unused)	AG34	(unused)	AJ34	(unused)	AL34	(unused)	AN34	(unused)	AR35	(GND)
AE35	(unused)	AG35	(unused)	AJ35	(unused)	AL35	(unused)	AN35	(unused)		
AE36	(GND)	AG36	(GND)	AJ36	(GND)	AL36	(GND)	AN36	(GND)		
AF1	(GND)	AH1	(GND)	AK1	(GND)	AM1	(GND)	AP1	(GND)	AT3	(GND)
AF2	(unused)	AH2	(unused)	AK2	(unused)	AM2	(unused)	AP2	(GND)	AT4	(GND)
AF3	(unused)	AH3	(unused)	AK3	(unused)	AM3	(unused)	AP3	(unused)	AT5	(GND)
AF4	(unused)	AH4	(unused)	AK4	(unused)	AM4	(unused)	AP4	(VDD)	AT6	(GND)
AF5	(GND)	AH5	(GND)	AK5	(GND)	AM5	(GND)	AP5	(unused)	AT7	(GND)
AF6	(unused)	AH6	(unused)	AK6	(unused)	AM6	(unused)	AP6	(unused)	AT8	(GND)
AF7	(GND)	AH7	(GND)	AK7	(GND)	AM7	(GND)	AP7	(unused)	AT9	(GND)
AF8	(unused)	AH8	(unused)	AK8	(unused)	AM8	(unused)	AP8	(unused)	AT10	(GND)
AF9	(TEST7)	AH9	(GND)	AK9	(GND)	AM9	(GND)	AP9	(unused)	AT11	(GND)
AF10	FLAGC3	AH10	(unused)	AK10	(unused)	AM10	(unused)	AP10	(unused)	AT12	(GND)
AF11	TCLKC1	AH11	(TEST6)	AK11	(GND)	AM11	(GND)	AP11	(unused)	AT13	(GND)
AF12	TCLKC0	AH12	VDD	AK12	(unused)	AM12	(unused)	AP12	(unused)	AT14	(GND)
AF13	LC2ACK	AH13	LC3ACK	AK13	(GND)	AM13	(GND)	AP13	(unused)	AT15	(GND)
AF14	LC2CLK	AH14	LC3CLK	AK14	(unused)	AM14	(unused)	AP14	(unused)	AT16	(GND)
AF15	LC2DAT0	AH15	LC3DAT0	AK15	(GND)	AM15	(GND)	AP15	(unused)	AT17	(GND)
AF16	LC2DAT1	AH16	LC3DAT1	AK16	GND	AM16	(unused)	AP16	(unused)	AT18	(GND)
AF17	LC2DAT2	AH17	LC3DAT2	AK17	VDD	AM17	(unused)	AP17	(unused)	AT19	(GND)
AF18	LC2DAT3	AH18	LC3DAT3	AK18	GND	AM18	(VDD)	AP18	(GND)	AT20	(GND)
AF19	DRD1	AH19	TCLKD1	AK19	VDD	AM19	(VDD)	AP19	(VDD)	AT21	(GND)
AF20	DRD0	AH20	TCLKD0	AK20	VDD	AM20	(unused)	AP20	(unused)	AT22	(GND)
AF21	$\overline{RD}$	AH21	IDD0	AK21	GND	AM21	(unused)	AP21	(unused)	AT23	(GND)
AF22	LD3ACK	AH22	IDD1	AK22	(GND)	AM22	(GND)	AP22	(unused)	AT24	(GND)
AF23	LD3CLK	AH23	IDD2	AK23	(unused)	AM23	(unused)	AP23	(unused)	AT25	(GND)
AF24	LD3DAT0	AH24	EBOOTBCD	AK24	(GND)	AM24	(GND)	AP24	(unused)	AT26	(GND)
AF25	LD3DAT1	AH25	TDOC	AK25	(unused)	AM25	(unused)	AP25	(unused)	AT27	(GND)
AF26	LD3DAT2	AH26	(TEST3)	AK26	(GND)	AM26	(GND)	AP26	(unused)	AT28	(GND)
AF27	LD3DAT3	AH27	(unused)	AK27	(unused)	AM27	(unused)	AP27	(unused)	AT29	(GND)
AF28	(TEST2)	AH28	(GND)	AK28	(GND)	AM28	(GND)	AP28	(unused)	AT30	(GND)
AF29	(unused)	AH29	(unused)	AK29	(unused)	AM29	(unused)	AP29	(unused)	AT31	(GND)
AF30	(GND)	AH30	(GND)	AK30	(GND)	AM30	(GND)	AP30	(unused)	AT32	(GND)
AF31	(unused)	AH31	(unused)	AK31	(unused)	AM31	(unused)	AP31	(unused)	AT33	(GND)
AF32	(GND)	AH32	(GND)	AK32	(GND)	AM32	(GND)	AP32	(unused)	AT34	(GND)
AF33	(unused)	AH33	(unused)	AK33	(unused)	AM33	(unused)	AP33	(GND)		
AF34	(unused)	AH34	(unused)	AK34	(unused)	AM34	(unused)	AP34	(unused)		
AF35	(unused)	AH35	(unused)	AK35	(unused)	AM35	(unused)	AP35	(VDD)		
AF36	(GND)	AH36	(GND)	AK36	(GND)	AM36	(GND)	AP36	(GND)		

# AD14160/AD14160L

## PIN CONFIGURATIONS (Alphabetical Listing)

Pin Name	Pin No.	Pin Name	Pin No.	Pin Name	Pin No.	Pin Name	Pin No.	Pin Name	Pin No.	Pin Name	Pin No.
ACK	J21	DATA21	K11	GND	N28	IRQA0	T28	LC2DAT2	AF17	TCLKD0	AH20
ADDR0	AC24	DATA22	L11	GND	P14	IRQA1	U29	LC2DAT3	AF18	TCLKD1	AH19
ADDR1	AC25	DATA23	M11	GND	P15	IRQA2	U28	LC3ACK	AH13	TDI	W30
ADDR2	AC26	DATA24	N11	GND	P22	IRQB0	R17	LC3CLK	AH14	TDO	AJ22
ADDR3	AC27	DATA25	P11	GND	P23	IRQB1	R18	LC3DAT0	AH15	TDOA	U30
ADDR4	AB24	DATA26	R11	GND	P24	IRQB2	R19	LC3DAT1	AH16	TDOB	AB13
ADDR5	AB25	DATA27	T11	GND	P25	IRQC0	AG13	LC3DAT2	AH17	TDOC	AH25
ADDR6	AB26	DATA28	V11	GND	P26	IRQC1	AG14	LC3DAT3	AH18	TFSA0	K20
ADDR7	AB27	DATA29	W11	GND	P27	IRQC2	AG15	LC4ACK	AJ13	TFSA1	K19
ADDR8	AA24	DATA30	L10	GND	R14	IRQD0	Y29	LC4CLK	AJ14	TFSB0	R9
ADDR9	AA25	DATA31	M10	GND	R15	IRQD1	AA29	LC4DAT0	AJ15	TFSB1	U8
ADDR10	AA26	DATA32	N10	GND	R16	IRQD2	AB29	LC4DAT1	AJ16	TFSC0	AE12
ADDR11	AA27	DATA33	P10	GND	R20	LA1ACK	K22	LC4DAT2	AJ17	TFSC1	AE11
ADDR12	Y24	DATA34	R10	GND	R21	LA1CLK	K23	LC4DAT3	AJ18	TFSD0	AG20
ADDR13	Y25	DATA35	T10	GND	R22	LA1DAT0	K24	LD1ACK	AD22	TFSD1	AG19
ADDR14	Y26	DATA36	U10	GND	T15	LA1DAT1	K25	LD1CLK	AD23	TIMEXPA	V30
ADDR15	Y27	DATA37	V10	GND	T16	LA1DAT2	K26	LD1DAT0	AD24	TIMEXPB	U16
ADDR16	W24	DATA38	W10	GND	T17	LA1DAT3	K27	LD1DAT1	AD25	TIMEXPC	AC23
ADDR17	W25	DATA39	X10	GND	T18	LA2ACK	L22	LD1DAT2	AD26	TIMEXPD	AD28
ADDR18	W26	DATA40	AA13	GND	T19	LA2CLK	L23	LD1DAT3	AD27	TMS	AD17
ADDR19	W27	DATA41	Y12	GND	T30	LA2DAT0	L24	LD2ACK	AE22	TRST	AD18
ADDR20	Y24	DATA42	AA12	GND	U7	LA2DAT1	L25	LD2CLK	AE23	VDD	G21
ADDR21	V25	DATA43	Y11	GND	U15	LA2DAT2	L26	LD2DAT0	AE24	VDD	H22
ADDR22	V26	DATA44	AA11	GND	U22	LA2DAT3	L27	LD2DAT1	AE25	VDD	H24
ADDR23	V27	DATA45	V9	GND	U23	LA3ACK	M22	LD2DAT2	AE26	VDD	J18
ADDR24	U24	DATA46	W9	GND	U20	LA3CLK	M23	LD2DAT3	AE27	VDD	J24
ADDR25	U25	DATA47	Y10	GND	V23	LA3DAT0	M24	LD3ACK	AF22	VDD	M18
ADDR26	U26	DMAG1	M15	GND	W7	LA3DAT1	M25	LD3CLK	AF23	VDD	M28
ADDR27	U27	DMAG2	N15	GND	W16	LA3DAT2	M26	LD3DAT0	AF24	VDD	N8
ADDR28	T24	DMAR1	M16	GND	W20	LA3DAT3	M27	LD3DAT1	AF25	VDD	N29
ADDR29	T25	DMAR2	M17	GND	W23	LA4ACK	N22	LD3DAT2	AF26	VDD	T7
ADDR30	T26	DRA0	J20	GND	Y16	LA4CLK	N23	LD3DAT3	AF27	VDD	T14
ADDR31	T27	DRA1	J19	GND	Y17	LA4DAT0	N24	LD4ACK	AG22	VDD	U14
ADRCLK	AC13	DRB0	P9	GND	Y22	LA4DAT1	N25	LD4CLK	AG23	VDD	U17
BMSA	V22	DRB1	T8	GND	Y23	LA4DAT2	N26	LD4DAT0	AG24	VDD	U18
BMSBCD	AD21	DRC0	AD12	GND	Y30	LA4DAT3	N27	LD4DAT1	AG25	VDD	U19
BR1	Y9	DRC1	AD11	GND	AA7	LB1ACK	H13	LD4DAT2	AG26	VDD	U20
BR2	AA9	DRD0	AF20	GND	AA16	LB1CLK	H14	LD4DAT3	AG27	VDD	U21
BR3	AB9	DRD1	AF19	GND	AA17	LB1DAT0	H15	MS0	R24	VDD	V18
BR4	AC9	DTA0	M20	GND	AA18	LB1DAT1	H16	MS1	R25	VDD	V19
BR5	AD9	DTA1	M19	GND	AA19	LB1DAT2	G17	MS2	R26	VDD	V21
BR6	AE9	DTB0	U9	GND	AA20	LB1DAT3	G18	MS3	R27	VDD	W17
CLKIN	U11	DTB1	W8	GND	AA23	LB2ACK	J13	PAGE	J22	VDD	W18
CPAA	M21	DTC0	AG12	GND	AB10	LB2CLK	J14	RCLKA0	H20	VDD	W19
CPAB	AA10	DTC1	AG11	GND	AB16	LB2DAT0	J15	RCLKA1	H19	VDD	W21
CPAC	AD13	DTD0	AJ20	GND	AB17	LB2DAT1	J16	RCLKB0	N9	VDD	W22
CPAD	AJ21	DTD1	AJ19	GND	AB18	LB2DAT2	H17	RCLKB1	R8	VDD	Y7
CSA	K21	EBOOTA	T29	GND	AB19	LB2DAT3	H18	RCLKC0	AC12	VDD	Y18
CSB	V7	EBOOTBCD	AH24	GND	AC8	LB3ACK	K13	RCLKC1	AC11	VDD	Y19
CSC	AD14	EMU	AD15	GND	AC18	LB3CLK	K14	RCLKD0	AE20	VDD	Y20
CSD	AG21	FLAGA0	V28	GND	AC19	LB3DAT0	K15	RCLKD1	AE19	VDD	Y21
DATA0	M14	FLAGA1	V29	GND	AC20	LB3DAT1	K16	RD	AF21	VDD	AA21
DATA1	N14	FLAGA2	W29	GND	AD16	LB3DAT2	K17	REDY	H21	VDD	AA22
DATA2	M13	FLAGA3	W28	GND	AD29	LB3DAT3	K18	RESET	L21	VDD	AA30
DATA3	N13	FLAGB0	V14	GND	AG10	LB4ACK	L13	RFSA0	G20	VDD	AB20
DATA4	P13	FLAGB1	V15	GND	AK16	LB4CLK	L14	RFSA1	G19	VDD	AB21
DATA5	R13	FLAGB2	V16	GND	AK18	LB4DAT0	L15	RFSB0	M9	VDD	AB22
DATA6	T13	FLAGB3	V17	GND	AK21	LB4DAT1	L16	RFSB1	P8	VDD	AB23
DATA7	U13	FLAGC0	AC10	GND	AB8	LB4DAT2	L17	RFSC0	AB12	VDD	AC14
DATA8	V13	FLAGC1	AD10	GND	AA8	LB4DAT3	L18	RFSC1	AB11	VDD	AC15
DATA9	W13	FLAGC2	AE10	IDA0	R28	LBOOTA	R29	RFSD0	AD20	VDD	AC16
DATA10	J12	FLAGC3	AF10	IDA1	P28	LBOOTBCD	AJ23	RFSD1	AD19	VDD	AC17
DATA11	K12	FLAGD0	Y28	IDA2	P29	LC1ACK	AE13	RPBA	R23	VDD	AC21
DATA12	L12	FLAGD1	AA28	IDB0	P16	LC1CLK	AE14	SBTS	N16	VDD	AC22
DATA13	M12	FLAGD2	AB28	IDB1	P17	LC1DAT0	AE15	SW	Y8	VDD	AC29
DATA14	N12	FLAGD3	AC28	IDB2	P18	LC1DAT1	AE16	TCK	AJ24	VDD	AD8
DATA15	P12	GND	G16	IDC0	AG16	LC1DAT2	AE17	TCLKA0	L20	VDD	AE28
DATA16	R12	GND	H23	IDC1	AG17	LC1DAT3	AE18	TCLKA1	L19	VDD	AH12
DATA17	T12	GND	J17	IDC2	AG18	LC2ACK	AF13	TCLKB0	T9	VDD	AK17
DATA18	U12	GND	J23	IDD0	AH21	LC2CLK	AF14	TCLKB1	V8	VDD	AK19
DATA19	V12	GND	J25	IDD1	AH22	LC2DAT0	AF15	TCLKC0	AF12	VDD	AK20
DATA20	W12	GND	K10	IDD2	AH23	LC2DAT1	AF16	TCLKC1	AF11	WR	AE21



## PIN CONFIGURATIONS (Alphabetical Listing *Continued*)

Pin Name	Pin No.	Pin Name	Pin No.	Pin Name	Pin No.	Pin Name	Pin No.	Pin Name	Pin No.	Pin Name	Pin No.
(GND)	A3	(GND)	F8	(GND)	P4	(GND)	AG36	(GND)	AN23	(TEST1)	W31
(GND)	A4	(GND)	F10	(GND)	P6	(GND)	AH1	(GND)	AN25	(TEST1)	Y31
(GND)	A5	(GND)	F12	(GND)	P31	(GND)	AH5	(GND)	AN27	(TEST2)	AE29
(GND)	A6	(GND)	F14	(GND)	P33	(GND)	AH7	(GND)	AN29	(TEST2)	AF28
(GND)	A7	(GND)	F16	(GND)	P36	(GND)	AH9	(GND)	AN31	(TEST3)	AH26
(GND)	A8	(GND)	F21	(GND)	R1	(GND)	AH28	(GND)	AN33	(TEST3)	AJ25
(GND)	A9	(GND)	F23	(GND)	R5	(GND)	AH30	(GND)	AN36	(TEST4)	AL19
(GND)	A10	(GND)	F25	(GND)	R7	(GND)	AH32	(GND)	AP1	(TEST4)	AL20
(GND)	A11	(GND)	F27	(GND)	R30	(GND)	AH36	(GND)	AP2	(TEST5)	AL17
(GND)	A12	(GND)	F29	(GND)	R32	(GND)	AJ1	(GND)	AP18	(TEST5)	AL18
(GND)	A13	(GND)	F31	(GND)	R36	(GND)	AJ4	(GND)	AP33	(TEST6)	AH11
(GND)	A14	(GND)	F33	(GND)	T1	(GND)	AJ6	(GND)	AP36	(TEST6)	AJ12
(GND)	A15	(GND)	F36	(GND)	T4	(GND)	AJ8	(GND)	AR2	(TEST7)	AE8
(GND)	A16	(GND)	G1	(GND)	T6	(GND)	AJ10	(GND)	AR35	(TEST7)	AF9
(GND)	A17	(GND)	G5	(GND)	T31	(GND)	AJ27	(GND)	AT3	(TEST8)	W6
(GND)	A18	(GND)	G7	(GND)	T33	(GND)	AJ29	(GND)	AT4	(TEST8)	Y6
(GND)	A19	(GND)	G9	(GND)	T36	(GND)	AJ31	(GND)	AT5	(TEST9)	U6
(GND)	A20	(GND)	G11	(GND)	U1	(GND)	AJ33	(GND)	AT6	(TEST9)	V6
(GND)	A21	(GND)	G13	(GND)	U36	(GND)	AJ36	(GND)	AT7	(TEST10)	L9
(GND)	A22	(GND)	G15	(GND)	V1	(GND)	AK1	(GND)	AT8	(TEST10)	M8
(GND)	A23	(GND)	G22	(GND)	V2	(GND)	AK5	(GND)	AT9	(TEST11)	H12
(GND)	A24	(GND)	G24	(GND)	V34	(GND)	AK7	(GND)	AT10	(TEST11)	J11
(GND)	A25	(GND)	G26	(GND)	V36	(GND)	AK9	(GND)	AT11	(TEST12)	F17
(GND)	A26	(GND)	G28	(GND)	W1	(GND)	AK11	(GND)	AT12	(TEST12)	F18
(GND)	A27	(GND)	G30	(GND)	W2	(GND)	AK13	(GND)	AT13	(TEST13)	F19
(GND)	A28	(GND)	G32	(GND)	W34	(GND)	AK15	(GND)	AT14	(TEST13)	F20
(GND)	A29	(GND)	G36	(GND)	W36	(GND)	AK22	(GND)	AT15	(TEST14)	H25
(GND)	A30	(GND)	H1	(GND)	Y1	(GND)	AK24	(GND)	AT16	(TEST14)	J26
(GND)	A31	(GND)	H4	(GND)	Y36	(GND)	AK26	(GND)	AT17	(TEST15)	L28
(GND)	A32	(GND)	H6	(GND)	AA1	(GND)	AK28	(GND)	AT18	(TEST15)	M29
(GND)	A33	(GND)	H8	(GND)	AA4	(GND)	AK30	(GND)	AT19	(TEST16)	U34
(GND)	A34	(GND)	H10	(GND)	AA6	(GND)	AK32	(GND)	AT20	(TEST16)	V31
(GND)	B2	(GND)	H27	(GND)	AA31	(GND)	AK36	(GND)	AT21	(unused)	B8
(GND)	B35	(GND)	H29	(GND)	AA33	(GND)	AL1	(GND)	AT22	(unused)	B4
(GND)	C1	(GND)	H31	(GND)	AA36	(GND)	AL4	(GND)	AT23	(unused)	B5
(GND)	C2	(GND)	H33	(GND)	AB1	(GND)	AL6	(GND)	AT24	(unused)	B6
(GND)	C18	(GND)	H36	(GND)	AB5	(GND)	AL8	(GND)	AT25	(unused)	B7
(GND)	C33	(GND)	J1	(GND)	AB7	(GND)	AL10	(GND)	AT26	(unused)	B8
(GND)	C36	(GND)	J5	(GND)	AB30	(GND)	AL12	(GND)	AT27	(unused)	B9
(GND)	D1	(GND)	J7	(GND)	AB32	(GND)	AL14	(GND)	AT28	(unused)	B10
(GND)	D4	(GND)	J9	(GND)	AB36	(GND)	AL16	(GND)	AT29	(unused)	B11
(GND)	D6	(GND)	J28	(GND)	AC1	(GND)	AL21	(GND)	AT30	(unused)	B12
(GND)	D8	(GND)	J30	(GND)	AC4	(GND)	AL23	(GND)	AT31	(unused)	B13
(GND)	D10	(GND)	J32	(GND)	AC6	(GND)	AL25	(GND)	AT32	(unused)	B14
(GND)	D12	(GND)	J36	(GND)	AC31	(GND)	AL27	(GND)	AT33	(unused)	B15
(GND)	D14	(GND)	K1	(GND)	AC33	(GND)	AL29	(GND)	AT34	(unused)	B16
(GND)	D16	(GND)	K4	(GND)	AC36	(GND)	AL31	(VDD)	C4	(unused)	B17
(GND)	D21	(GND)	K6	(GND)	AD1	(GND)	AL33	(VDD)	C19	(unused)	B18
(GND)	D23	(GND)	K8	(GND)	AD5	(GND)	AL36	(VDD)	C35	(unused)	B19
(GND)	D25	(GND)	K29	(GND)	AD7	(GND)	AM1	(VDD)	D18	(unused)	B20
(GND)	D27	(GND)	K31	(GND)	AD30	(GND)	AM5	(VDD)	D19	(unused)	B21
(GND)	D29	(GND)	K33	(GND)	AD32	(GND)	AM7	(VDD)	E18	(unused)	B22
(GND)	D31	(GND)	K36	(GND)	AD36	(GND)	AM9	(VDD)	E19	(unused)	B23
(GND)	D33	(GND)	L1	(GND)	AE1	(GND)	AM11	(VDD)	V3	(unused)	B24
(GND)	D36	(GND)	L5	(GND)	AE4	(GND)	AM13	(VDD)	V4	(unused)	B25
(GND)	E1	(GND)	L7	(GND)	AE6	(GND)	AM15	(VDD)	V5	(unused)	B26
(GND)	E5	(GND)	L30	(GND)	AE31	(GND)	AM22	(VDD)	V32	(unused)	B27
(GND)	E7	(GND)	L32	(GND)	AE33	(GND)	AM24	(VDD)	V33	(unused)	B28
(GND)	E9	(GND)	L36	(GND)	AE36	(GND)	AM26	(VDD)	V35	(unused)	B29
(GND)	E11	(GND)	M1	(GND)	AF1	(GND)	AM28	(VDD)	W3	(unused)	B30
(GND)	E13	(GND)	M4	(GND)	AF5	(GND)	AM30	(VDD)	W4	(unused)	B31
(GND)	E15	(GND)	M6	(GND)	AF7	(GND)	AM32	(VDD)	W5	(unused)	B32
(GND)	E22	(GND)	M31	(GND)	AF30	(GND)	AM36	(VDD)	W32	(unused)	B33
(GND)	E24	(GND)	M33	(GND)	AF32	(GND)	AN1	(VDD)	W33	(unused)	B34
(GND)	E26	(GND)	M36	(GND)	AF36	(GND)	AN4	(VDD)	W35	(unused)	C3
(GND)	E28	(GND)	N1	(GND)	AG1	(GND)	AN6	(VDD)	AM18	(unused)	C5
(GND)	E30	(GND)	N5	(GND)	AG4	(GND)	AN8	(VDD)	AM19	(unused)	C6
(GND)	E32	(GND)	N7	(GND)	AG6	(GND)	AN10	(VDD)	AN18	(unused)	C7
(GND)	E36	(GND)	N30	(GND)	AG8	(GND)	AN12	(VDD)	AN19	(unused)	C8
(GND)	F1	(GND)	N32	(GND)	AG29	(GND)	AN14	(VDD)	AP4	(unused)	C9
(GND)	F4	(GND)	N36	(GND)	AG31	(GND)	AN16	(VDD)	AP19	(unused)	C10
(GND)	F6	(GND)	P1	(GND)	AG33	(GND)	AN21	(VDD)	AP35	(unused)	C11

# AD14160/AD14160L

## PIN CONFIGURATIONS (Alphabetical Listing *Continued*)

Pin Name	Pin No.	Pin Name	Pin No.	Pin Name	Pin No.	Pin Name	Pin No.	Pin Name	Pin No.	Pin Name	Pin No.
(unused)	C12	(unused)	F34	(unused)	N4	(unused)	AB14	(unused)	AJ34	(unused)	AP3
(unused)	C13	(unused)	F35	(unused)	N6	(unused)	AB15	(unused)	AJ35	(unused)	AP5
(unused)	C14	(unused)	G2	(unused)	N17	(unused)	AB31	(unused)	AK2	(unused)	AP6
(unused)	C15	(unused)	G3	(unused)	N18	(unused)	AB33	(unused)	AK3	(unused)	AP7
(unused)	C16	(unused)	G4	(unused)	N19	(unused)	AB34	(unused)	AK4	(unused)	AP8
(unused)	C17	(unused)	G6	(unused)	N20	(unused)	AB35	(unused)	AK6	(unused)	AP9
(unused)	C20	(unused)	G8	(unused)	N21	(unused)	AC2	(unused)	AK8	(unused)	AP10
(unused)	C21	(unused)	G10	(unused)	N31	(unused)	AC3	(unused)	AK10	(unused)	AP11
(unused)	C22	(unused)	G12	(unused)	N33	(unused)	AC5	(unused)	AK12	(unused)	AP12
(unused)	C23	(unused)	G14	(unused)	N34	(unused)	AC7	(unused)	AK14	(unused)	AP13
(unused)	C24	(unused)	G23	(unused)	N35	(unused)	AC30	(unused)	AK23	(unused)	AP14
(unused)	C25	(unused)	G25	(unused)	P2	(unused)	AC32	(unused)	AK25	(unused)	AP15
(unused)	C26	(unused)	G27	(unused)	P3	(unused)	AC34	(unused)	AK27	(unused)	AP16
(unused)	C27	(unused)	G29	(unused)	P5	(unused)	AC35	(unused)	AK29	(unused)	AP17
(unused)	C28	(unused)	G31	(unused)	P7	(unused)	AD2	(unused)	AK31	(unused)	AP20
(unused)	C29	(unused)	G33	(unused)	P19	(unused)	AD3	(unused)	AK33	(unused)	AP21
(unused)	C30	(unused)	G34	(unused)	P20	(unused)	AD4	(unused)	AK34	(unused)	AP22
(unused)	C31	(unused)	G35	(unused)	P21	(unused)	AD6	(unused)	AK35	(unused)	AP23
(unused)	C32	(unused)	H2	(unused)	P30	(unused)	AD31	(unused)	AL2	(unused)	AP24
(unused)	C34	(unused)	H5	(unused)	P32	(unused)	AD33	(unused)	AL3	(unused)	AP25
(unused)	D2	(unused)	H5	(unused)	P34	(unused)	AD34	(unused)	AL5	(unused)	AP26
(unused)	D5	(unused)	H7	(unused)	P35	(unused)	AD35	(unused)	AL7	(unused)	AP27
(unused)	D5	(unused)	H9	(unused)	R2	(unused)	AE2	(unused)	AL9	(unused)	AP28
(unused)	D7	(unused)	H11	(unused)	R3	(unused)	AE3	(unused)	AL11	(unused)	AP29
(unused)	D9	(unused)	H26	(unused)	R4	(unused)	AE5	(unused)	AL13	(unused)	AP30
(unused)	D11	(unused)	K28	(unused)	R6	(unused)	AE7	(unused)	AL15	(unused)	AP31
(unused)	D13	(unused)	H30	(unused)	R31	(unused)	AE30	(unused)	AL22	(unused)	AP32
(unused)	D15	(unused)	H32	(unused)	R33	(unused)	AE32	(unused)	AL24	(unused)	AP34
(unused)	D17	(unused)	H34	(unused)	R34	(unused)	AE34	(unused)	AL26	(unused)	AR3
(unused)	D20	(unused)	H35	(unused)	R35	(unused)	AE35	(unused)	AL28	(unused)	AR4
(unused)	D22	(unused)	J2	(unused)	T2	(unused)	AF2	(unused)	AL30	(unused)	AR5
(unused)	D24	(unused)	J3	(unused)	T3	(unused)	AF3	(unused)	AL32	(unused)	AR6
(unused)	D26	(unused)	J4	(unused)	T5	(unused)	AF4	(unused)	AL34	(unused)	AR7
(unused)	D28	(unused)	J6	(unused)	T20	(unused)	AF6	(unused)	AL35	(unused)	AR8
(unused)	D30	(unused)	J8	(unused)	T21	(unused)	AF8	(unused)	AM2	(unused)	AR9
(unused)	D32	(unused)	J10	(unused)	T22	(unused)	AF29	(unused)	AM3	(unused)	AR10
(unused)	D34	(unused)	J27	(unused)	T23	(unused)	AF31	(unused)	AM4	(unused)	AR11
(unused)	D35	(unused)	J29	(unused)	T32	(unused)	AF33	(unused)	AM6	(unused)	AR12
(unused)	E2	(unused)	J31	(unused)	T34	(unused)	AF34	(unused)	AM8	(unused)	AR13
(unused)	E3	(unused)	J33	(unused)	T35	(unused)	AF35	(unused)	AM10	(unused)	AR14
(unused)	E4	(unused)	J34	(unused)	U2	(unused)	AG2	(unused)	AM12	(unused)	AR15
(unused)	E6	(unused)	J35	(unused)	U3	(unused)	AG3	(unused)	AM14	(unused)	AR16
(unused)	E8	(unused)	K2	(unused)	U4	(unused)	AG5	(unused)	AM16	(unused)	AR17
(unused)	E10	(unused)	K3	(unused)	U5	(unused)	AG7	(unused)	AM17	(unused)	AR18
(unused)	E12	(unused)	K5	(unused)	U32	(unused)	AG9	(unused)	AM20	(unused)	AR19
(unused)	E14	(unused)	K7	(unused)	U33	(unused)	AG28	(unused)	AM21	(unused)	AR20
(unused)	E16	(unused)	K9	(unused)	U34	(unused)	AG30	(unused)	AM23	(unused)	AR21
(unused)	E17	(unused)	K28	(unused)	U35	(unused)	AG32	(unused)	AM25	(unused)	AR22
(unused)	E20	(unused)	K30	(unused)	W14	(unused)	AG34	(unused)	AM27	(unused)	AR23
(unused)	E21	(unused)	K32	(unused)	W15	(unused)	AG35	(unused)	AM29	(unused)	AR24
(unused)	E23	(unused)	K34	(unused)	Y2	(unused)	AH2	(unused)	AM31	(unused)	AR25
(unused)	E25	(unused)	K35	(unused)	Y3	(unused)	AH3	(unused)	AM33	(unused)	AR26
(unused)	E27	(unused)	L2	(unused)	Y4	(unused)	AH4	(unused)	AM34	(unused)	AR27
(unused)	E29	(unused)	L3	(unused)	Y5	(unused)	AH6	(unused)	AM35	(unused)	AR28
(unused)	E31	(unused)	L4	(unused)	Y14	(unused)	AH8	(unused)	AN2	(unused)	AR29
(unused)	E33	(unused)	L6	(unused)	Y15	(unused)	AH10	(unused)	AN3	(unused)	AR30
(unused)	E34	(unused)	L8	(unused)	Y32	(unused)	AH27	(unused)	AN5	(unused)	AR31
(unused)	E35	(unused)	L29	(unused)	Y33	(unused)	AH29	(unused)	AN7	(unused)	AR32
(unused)	F2	(unused)	L31	(unused)	Y34	(unused)	AH31	(unused)	AN9	(unused)	AR33
(unused)	F3	(unused)	L33	(unused)	Y35	(unused)	AH33	(unused)	AN11	(unused)	AR34
(unused)	F5	(unused)	L34	(unused)	AA2	(unused)	AH34	(unused)	AN13	(unused)	
(unused)	F7	(unused)	L35	(unused)	AA3	(unused)	AH35	(unused)	AN15	(unused)	
(unused)	F9	(unused)	M2	(unused)	AA5	(unused)	AJ2	(unused)	AN17	(unused)	
(unused)	F11	(unused)	M3	(unused)	AA14	(unused)	AJ3	(unused)	AN20	(unused)	
(unused)	F13	(unused)	M5	(unused)	AA15	(unused)	AJ5	(unused)	AN22	(unused)	
(unused)	F15	(unused)	M7	(unused)	AA32	(unused)	AJ7	(unused)	AN24	(unused)	
(unused)	F22	(unused)	M30	(unused)	AA34	(unused)	AJ9	(unused)	AN26	(unused)	
(unused)	F24	(unused)	M32	(unused)	AA35	(unused)	AJ11	(unused)	AN28	(unused)	
(unused)	F26	(unused)	M34	(unused)	AB2	(unused)	AJ26	(unused)	AN30	(unused)	
(unused)	F28	(unused)	M35	(unused)	AB3	(unused)	AJ28	(unused)	AN32	(unused)	
(unused)	F30	(unused)	N2	(unused)	AB4	(unused)	AJ30	(unused)	AN34	(unused)	
(unused)	F32	(unused)	N3	(unused)	AB6	(unused)	AJ32	(unused)	AN35	(unused)	

## ORDERING GUIDE

Part Number	Case Temperature Range	Instruction Rate	Operating Voltage
AD14160BB-4*	-40°C to +100°C	40 MHz	5 V
AD14160/AD14160LBB-4*	-40°C to +100°C	40 MHz	3.3 V
AD14160KB-4	0°C to +85°C	40 MHz	5 V
AD14160/AD14160LKB-4	0°C to +85°C	40 MHz	3.3 V

### NOTES

1. Part numbers marked with an \* are shipping as x-grade (preproduction) material at the time of this printing.
2. These parts are packaged in a 452-lead Ceramic Ball Grid Array Package (CBGA).
3. Military and Industrial temperature SMD parts, in the same package are in development.

### PACKAGE DIMENSIONS

Dimensions shown in inches and (mm).

#### 452-Lead Ceramic Ball Grid Array (CBGA) (QS-452)

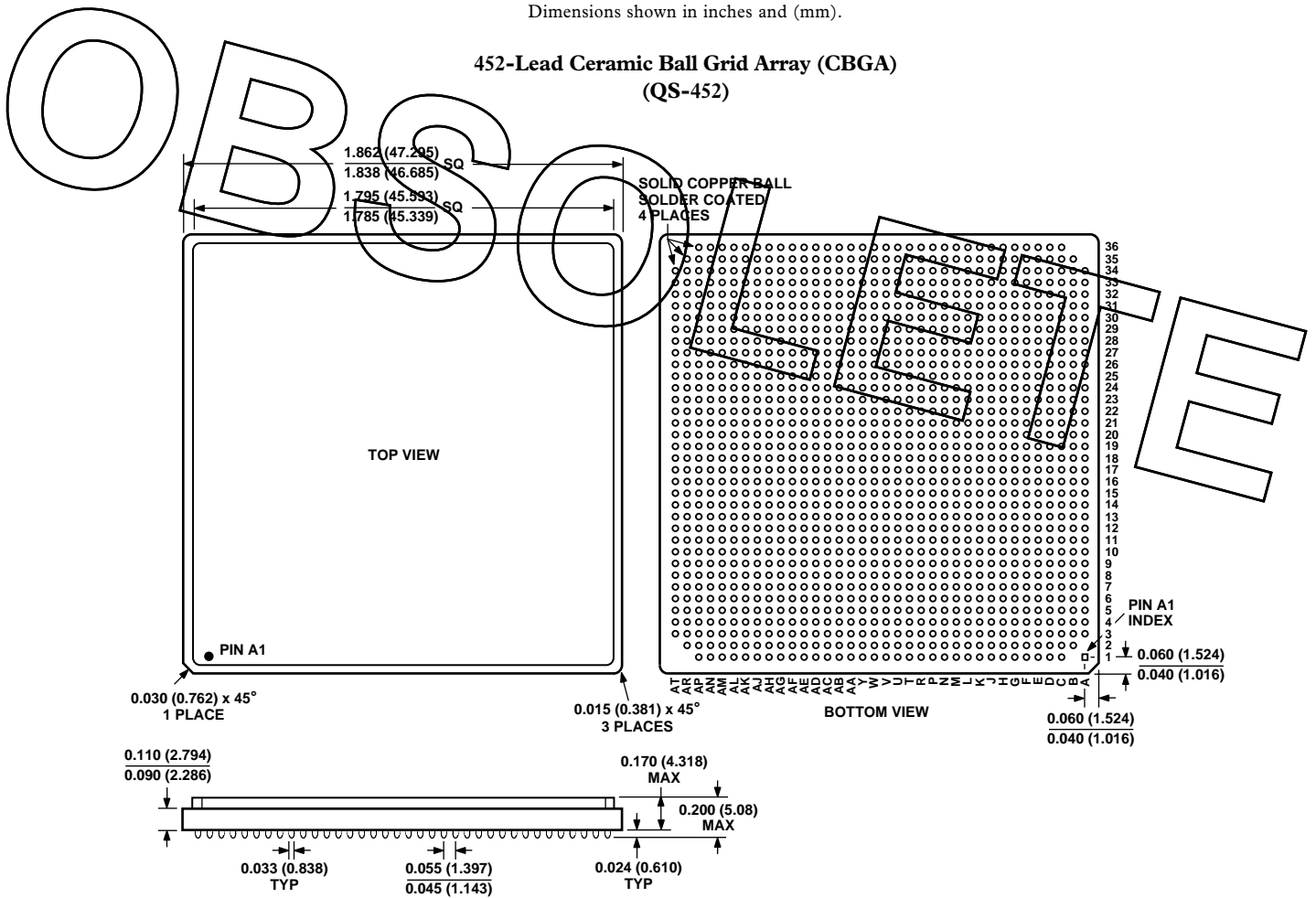

OBSOLETE