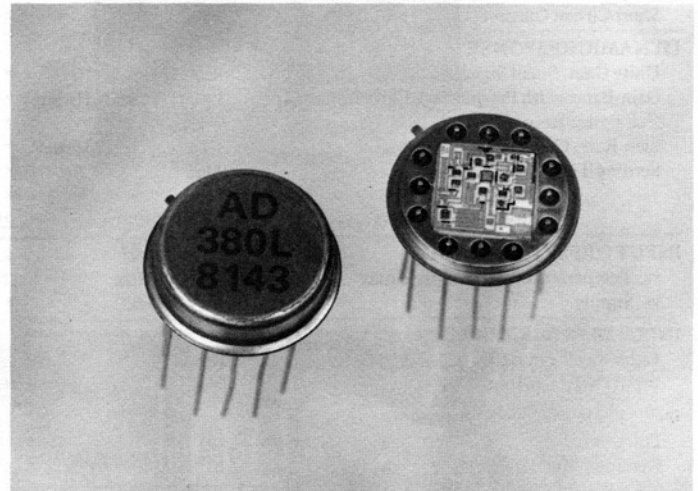

**FEATURES****High Output Current: 50mA @  $\pm 10V$** **Fast Settling to 0.1%: 130ns****High Slew Rate: 330V/ $\mu$ s****High Gain-Bandwidth Product: 300MHz****High Unity Gain Bandwidth: 40MHz****Low Offset Voltage (1mV for AD380K, L, S)****PRODUCT DESCRIPTION**

The AD380 is a hybrid operational amplifier that combines the low input bias current advantages of a FET input stage with the high slew rate and line driving capability of a fast, high power output amplifier.

The AD380 has a slew rate of 330V/ $\mu$ s and will output  $\pm 10V$  at  $\pm 50mA$ . A single external compensation capacitor allows the user to optimize the bandwidth, slew rate, or settling time for the given application.

A true differential input ensures equally superior performance in all system designs whether they are inverting, noninverting, or differential.

The AD380 is especially designed for use in applications, such as fast A/D, D/A and sampling circuits, that require fast and smooth settling and FET input parameters.

The AD380 is offered in three commercial versions, J, K and L specified from 0 to +70°C and one military version, the S, specified from -55°C to +125°C. All grades are packaged in hermetically sealed TO-8 style cans. The S grade is available screened to MIL-STD-883, Level B, Method 5008.

**PRODUCT HIGHLIGHTS**

1. The AD380's high output current (50mA @  $\pm 10V$ ) makes it suitable for driving terminated 200 $\Omega$  twisted pairs.
2. The fast settling output (250ns to 0.01%) makes the AD380 an ideal choice for video A/D and D/A converters and sample and hold applications.
3. The settling wave forms are not only fast but are also very smooth. The absence of large overshoot and oscillations makes the AD380 a very predictable and dependable system element.
4. The high gain-bandwidth product (300MHz) ensures low distortion in high frequency applications.
5. Quick, symmetrical overdrive recovery time (250ns) is assured by an internal antisaturation diode. This is useful in applications where large transient signals may occur.
6. The precision input (1mV offset, max), along with fast settling and high current output make the AD380 an excellent choice for:
  - ATE pin drivers
  - precision coax buffers
  - signal conditioning on pulse waveforms
  - high resolution graphics displays.

# SPECIFICATIONS (typical @ +25°C and $V_S = \pm 15V$ dc unless otherwise specified)

MODEL	AD380JH	AD380KH	AD380LH	AD380SH (AD380SH/883B) <sup>1</sup>
<b>OPEN LOOP GAIN</b>				
$V_{OUT} = \pm 10V$ , no load	40,000 min	*	*	*
$V_{OUT} = \pm 10V$ , $R_L \geq 200\Omega$	25,000 min	*	*	*
<b>OUTPUT CHARACTERISTICS</b>				
Voltage @ $R_L = 200\Omega$ , $T_A = \text{min to max}$	$\pm 12V$ ( $\pm 10V$ min)	*	*	*
Output Impedance (Open Loop)	100 $\Omega$	*	*	*
Short Circuit Current	100mA	*	*	*
<b>DYNAMIC RESPONSE</b>				
Unity Gain, Small Signal	40MHz	*	*	*
Gain-Bandwidth Product, $f = 100kHz$ , $C_C = 1pF$	300MHz (200MHz min)	*	*	*
Full Power Response	6MHz	*	*	*
Slew Rate, $C_C = 1pF$ , 20V Swing	330V/ $\mu s$ (200V/ $\mu s$ min)	*	*	*
Settling Time: 10V Step to 1%	90ns	*	*	*
10V Step to 0.1%	130ns	*	*	*
10V Step to 0.01%	250ns	250ns (400ns max)	**	**
<b>INPUT OFFSET VOLTAGE</b>				
vs. Temperature <sup>2</sup> , $T_A = \text{min to max}$	2.0mV max	1.0mV max	**	**
vs. Supply	50 $\mu V/^\circ C$ max	20 $\mu V/^\circ C$ max	10 $\mu V/^\circ C$ max	50 $\mu V/^\circ C$ max
	1mV/V max	*	*	*
<b>INPUT BIAS CURRENT</b>				
Either Input, Initial <sup>3</sup>	10pA (100pA max)	*	*	*
Input Offset Current	5pA	*	*	*
<b>INPUT IMPEDANCE</b>				
Differential	10 <sup>11</sup> $\Omega$   6pF	*	*	*
Common Mode	10 <sup>11</sup> $\Omega$   6pF	*	*	*
<b>INPUT VOLTAGE RANGE</b>				
Differential <sup>4</sup>	$\pm 20V$	*	*	*
Common Mode	$\pm 12V$ ( $\pm 10V$ min)	*	*	*
Common Mode Rejection, $V_{IN} = \pm 10V$	60dB min	*	*	*
<b>POWER SUPPLY</b>				
Rated Performance	$\pm 15V$	*	*	*
Operating	$\pm$ (6 to 20)V	*	*	*
Quiescent Current	12mA (15mA max)	*	*	*
<b>VOLTAGE NOISE</b>				
0.1Hz to 100Hz	3.3 $\mu V$ p-p (0.5 $\mu V$ rms)	*	*	*
100Hz to 10kHz	6.6 $\mu V$ p-p (1 $\mu V$ rms)	*	*	*
10kHz to 1MHz	40 $\mu V$ p-p (6 $\mu V$ rms)	*	*	*
<b>TEMPERATURE RANGE</b>				
Operating, Rated Performance	0 to +70°C	*	*	-55°C to +125°C
Storage	-65°C to +150°C	*	*	*
Thermal Resistance $\theta_{JA}$	100°C/W	*	*	*
$\theta_{JC}$	70°C/W	*	*	*

## NOTES

<sup>1</sup>The AD380SH is offered screened to MIL-STD-883, Level B, Method 5008.

<sup>2</sup>Input Offset Voltage Drift is specified with the offset voltage unnull. Nulling will induce an additional 3 $\mu V/^\circ C/mV$  of offset null.

<sup>3</sup>Bias Current specifications are guaranteed maximum at either input at  $T_{CASE} = +25^\circ C$ . For higher temperatures see Figure 16.

<sup>4</sup>Defined as the maximum safe voltage between inputs such that neither exceeds  $\pm 10V$  from ground.

\*Specifications same as AD380JH.

\*\*Specifications same as AD380KH.

Specifications subject to change without notice.

## OUTLINE DIMENSIONS

Dimensions shown in inches and (mm).

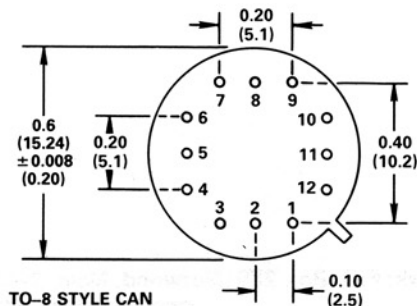

BOTTOM VIEW

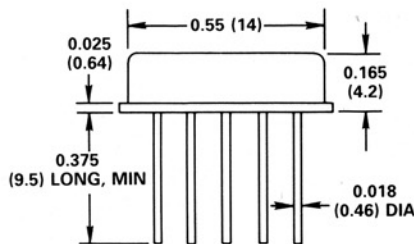

## PIN CONFIGURATION

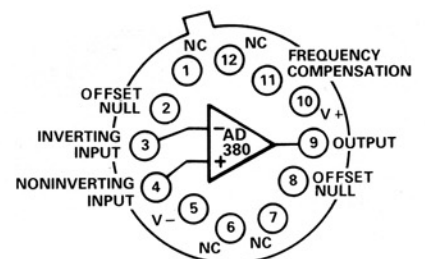

TOP VIEW

# Typical Characteristics

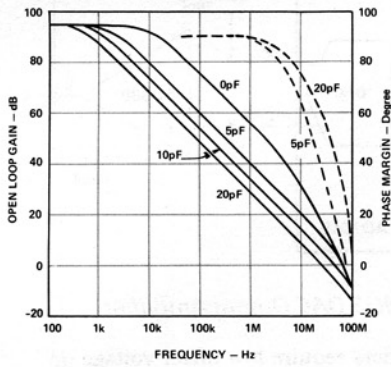

Figure 1. Open Loop Frequency Response

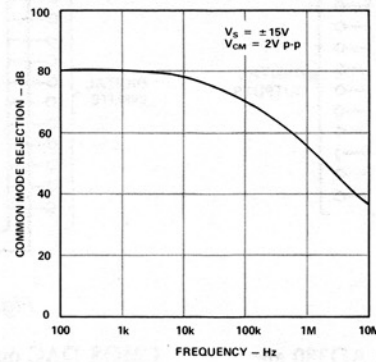

Figure 2. CMRR vs. Frequency

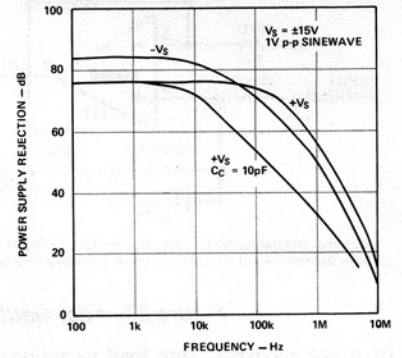

Figure 3. PSRR vs. Frequency

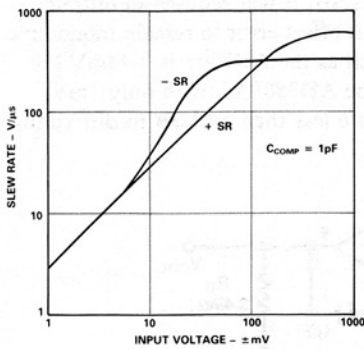

Figure 4. Slew Rate vs. Differential Input Voltage

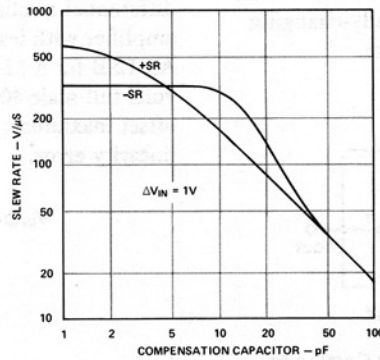

Figure 5. Slew Rate vs. Compensation Capacitor

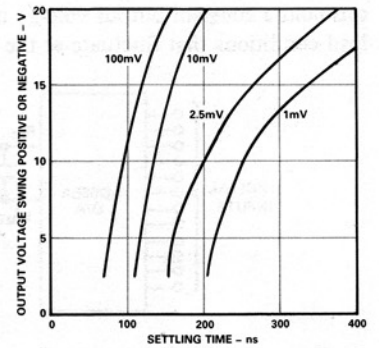

Figure 6. Output Settling Time vs. Output Voltage Swing and Error

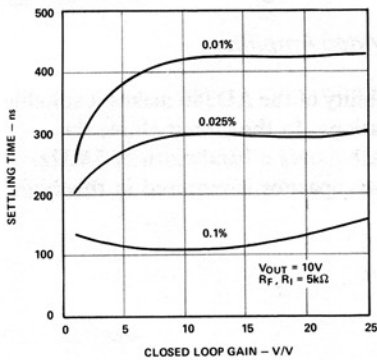

Figure 7. Settling Time vs. Closed Loop Gain

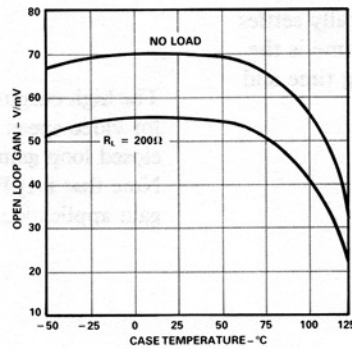

Figure 8. Gain vs. Temperature

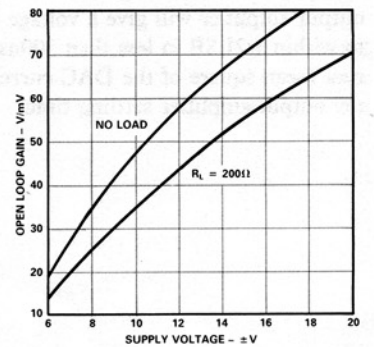

Figure 9. Gain vs. Supply Voltage

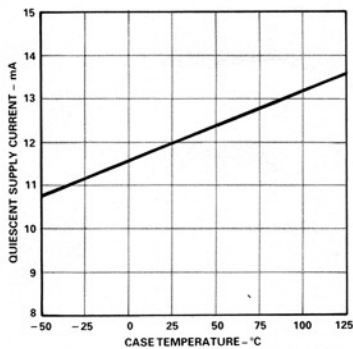

Figure 10. Supply Current vs. Temperature

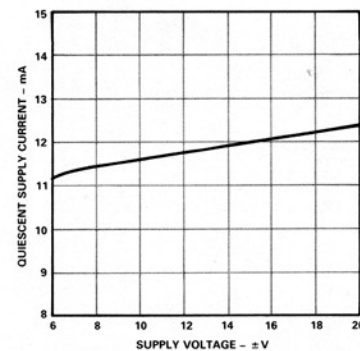

Figure 11. Supply Current vs. Supply Voltage

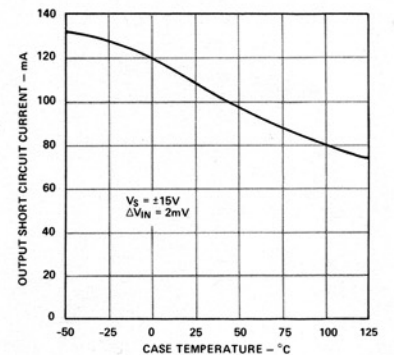

Figure 12.  $I_{SC}$  vs. Temperature

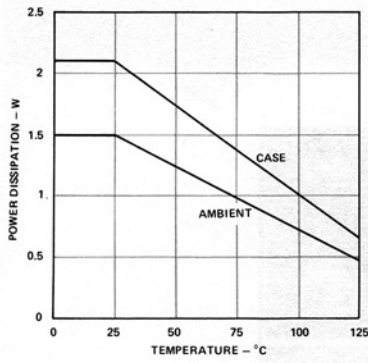

Figure 13. Power Dissipation vs. Temperature

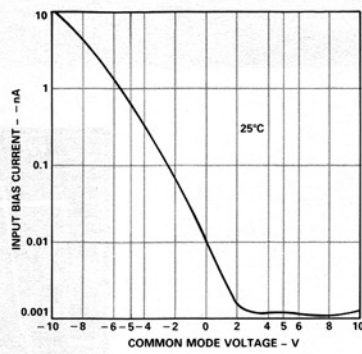

Figure 14. Input Bias Current vs. Common Mode Voltage

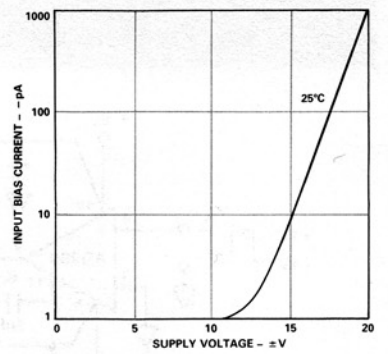

Figure 15. Input Bias Current vs. Supply Voltage

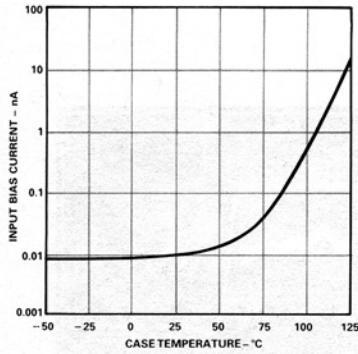

Figure 16. Input Bias Current vs. Temperature

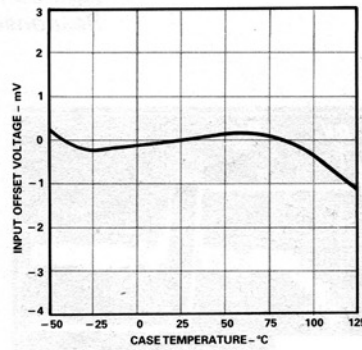

Figure 17. Offset Voltage vs. Temperature

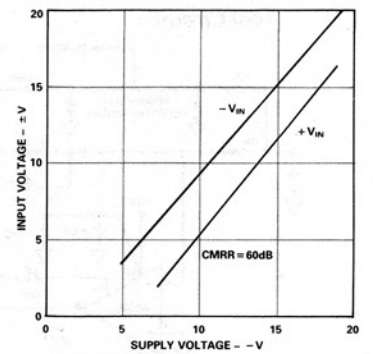

Figure 18. Input Voltage Range vs. Supply Voltage

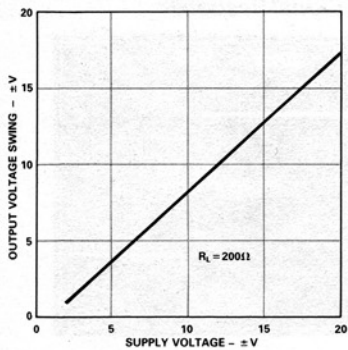

Figure 19. Output Voltage Swing vs. Supply Voltage

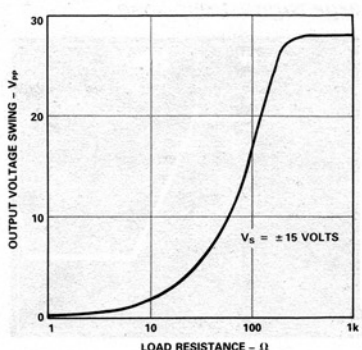

Figure 20. Output Voltage Swing vs. Load Resistance

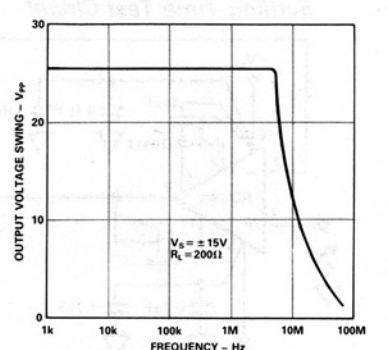

Figure 21. Large Signal Frequency Response

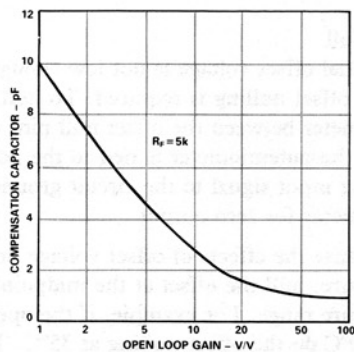

Figure 22. Recommended Compensation Capacitor vs. Closed Loop Gain

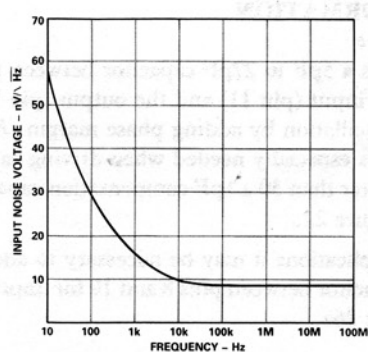

Figure 23. Input Noise Voltage Spectral Density



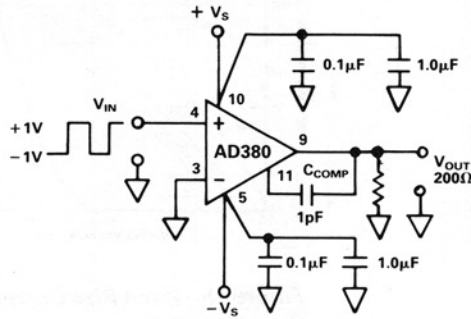

Figure 24a. Overdrive Recovery Test Circuit

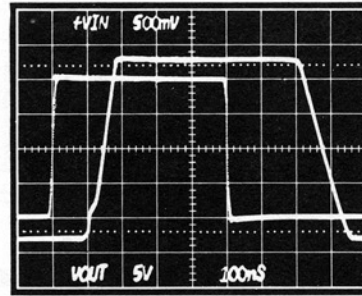

Figure 24b. Overdrive Recovery Response

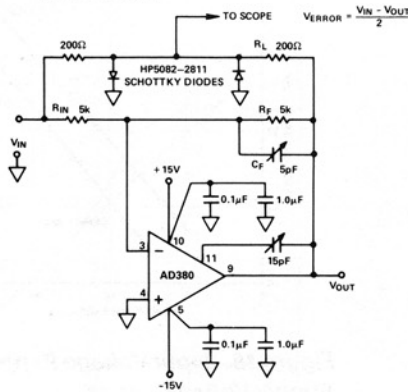

Figure 25a. Unity Gain Inverter Settling Time Test Circuit

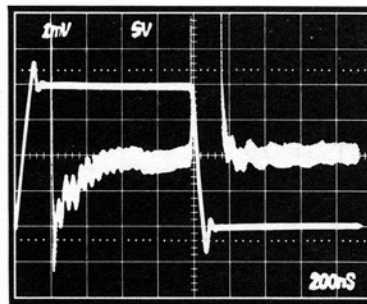

Figure 25b. Unity Gain Inverter Large Signal Response

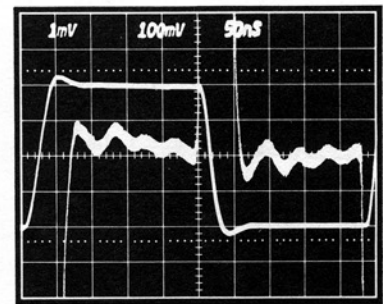

Figure 25c. Unity Gain Inverter Small Signal Response

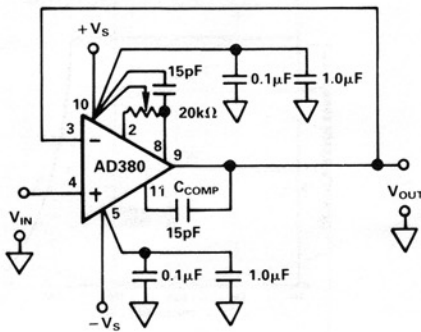

Figure 26a. Unity Gain Buffer Circuit

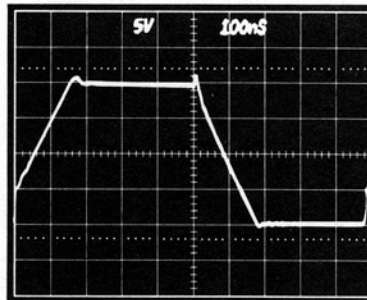

Figure 26b. Unity Gain Buffer Large Signal Response

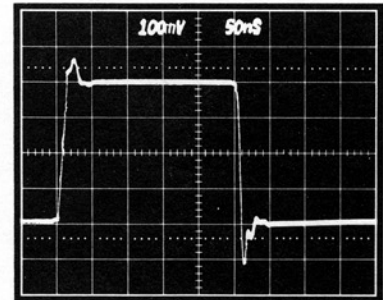

Figure 26c. Unity Gain Small Signal Response

## APPLICATIONS INFORMATION

### Compensation Capacitor

For low gain applications a 5pF to 27pF capacitor between the frequency compensation input (pin 11) and the output (pin 9) will reduce the risk of oscillation by adding phase margin. A compensation capacitor is especially needed when driving capacitive loads. For gains greater than 30 a 1pF compensation capacitor is recommended; see Figure 22.

For unity gain buffer applications it may be necessary to add a small (10pF to 20pF) capacitor between pins 8 and 10 for improved phase margin; see Figure 26a.

### Offset Null

If the initial offset voltage is not low enough for the user's application offset nulling is required. To null the offset tie a 20kΩ potentiometer between the offset null pins (pins 2 and 8). The wiper of the potentiometer is tied to the positive supply. With the analog input signal to the circuit grounded, adjust the potentiometer for zero output.

To minimize the effects of offset voltage drift as a function of temperature, null the offset at the midpoint of the operating temperature range. For example, if the operating environment is 0°C to 70°C do the offset nulling at 35°C. This will insure a maximum offset voltage drift of 35 times the  $V_{OS}$  drift specification at either temperature extreme.

## Typical Circuits

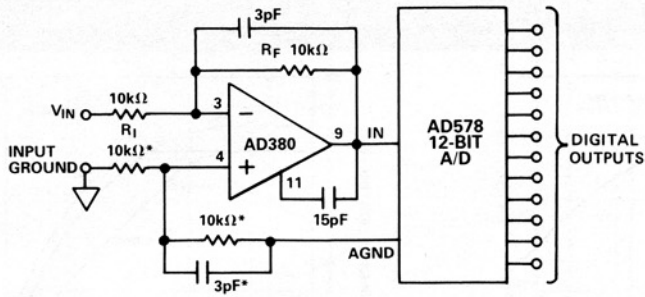

\*Optional Differential Input Components Used to Reject Noise Between Input Ground and the A/D Analog Ground.

Figure 27. Fast-Settling Buffer

Its quick recovery from load variations makes the AD380 an excellent buffer for fast successive approximation A/D converters; see Figure 27.

Many high speed A/D converters require a wideband buffer that can hold a constant output voltage under dynamically-changing load conditions that fluctuate at the bit decision rate.

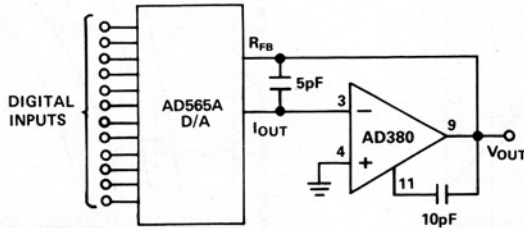

Figure 28. 12-Bit Voltage Output DAC Circuit Settles to 1/2LSB in 300ns

The AD565A 12-bit digital to analog converter with an AD380 output amplifier will give a voltage output that typically settles to within 1/2LSB in less than 300ns. Total settling time is the root mean square of the DAC current output settling time and the output amplifier settling time.

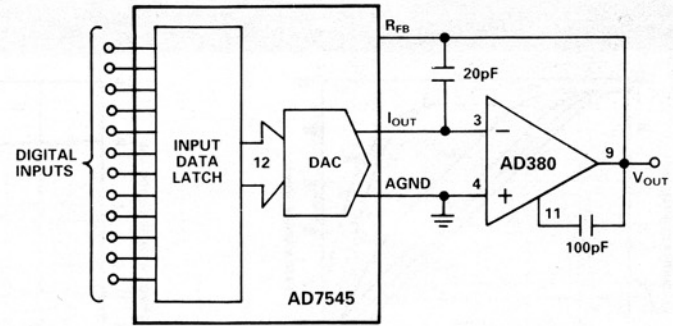

Figure 29. CMOS DAC Output Amplifier

CMOS DAC output amplifiers require low offset voltage op amps. The output impedance of CMOS DACs varies with input code. This can cause a code dependent error term at the output that approaches the op amps' offset voltage. If the DAC has a differential nonlinearity of 1/2LSB, it will require an output amplifier with less than 1/2LSB offset error to remain monotonic. An LSB for a 12-bit DAC such as the AD7545 is 2.44mV (10 volts full scale/4096). Thus, the AD380KH, with only 1mV offset maximum, will contribute less than 1/2LSB to differential linearity error.

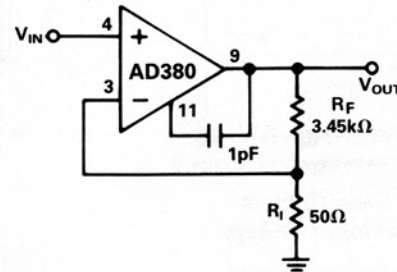

Figure 30. Video Amplifier

The high output current capability of the AD380 makes it suitable for video speed driver applications. In the circuit above the closed loop gain of 70 is available over a bandwidth of 5MHz. Note that a 1pF compensation capacitor is required in this high gain application.