

**FEATURES**

Suitable for 12-Bit Applications  
High Sample/Hold Current Ratio:  $10^7$   
Low Acquisition Time:  $6\mu\text{s}$  to 0.1%  
Low Charge Transfer:  $<2\text{pC}$   
High Input Impedance in Sample and Hold Modes  
Connect in Any Op Amp Configuration  
Differential Logic Inputs

**PRODUCT DESCRIPTION**

The AD582 is a low cost integrated circuit sample and hold amplifier consisting of a high performance operational amplifier, a low leakage analog switch and a JFET integrating amplifier — all fabricated on a single monolithic chip. An external holding capacitor, connected to the device, completes the sample and hold function.

With the analog switch closed, the AD582 functions like a standard op amp; any feedback network may be connected around the device to control gain and frequency response. With the switch open, the capacitor holds the output at its last level, regardless of input voltage.

Typical applications for the AD582 include sampled data systems, D/A deglitchers, analog de-multiplexers, auto null systems, strobed measurement systems and A/D speed enhancement.

The device is available in two versions: the "K" specified for operation over the 0 to  $+70^\circ\text{C}$  commercial temperature range and the "S" specified over the extended temperature range,  $-55^\circ\text{C}$  to  $+125^\circ\text{C}$ . All versions may be obtained in either the hermetic sealed, TO-100 can or the TO-116 DIP.

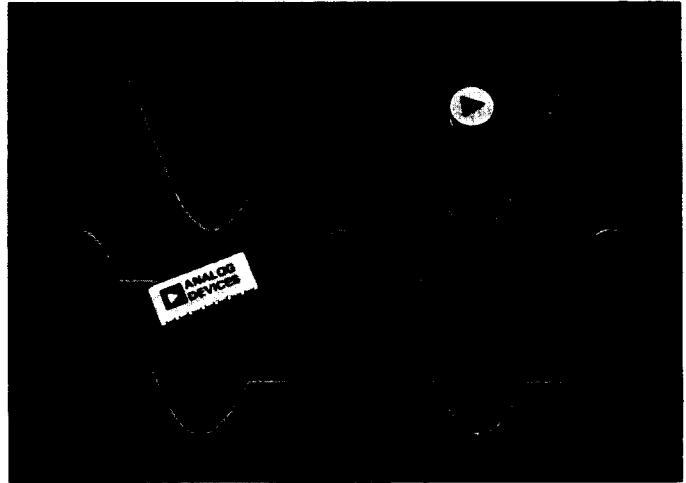
**PRODUCT HIGHLIGHTS**

1. The specially designed input stage presents a high impedance to the signal source in both sample and hold modes (up to  $\pm 12\text{V}$ ). Even with signal levels up to  $\pm V_S$ , no undesirable signal inversion, peaking or loss of hold voltage occurs.
2. The AD582 may be connected in any standard op amp configuration to control gain or frequency response and provide signal inversion, etc.
3. The AD582 offers a high, sample-to-hold current ratio:  $10^7$ . The ratio of the available charging current to the holding leakage current is often used as a figure of merit for a sample and hold circuit.
4. The AD582 has a typical charge transfer less than  $2\text{pC}$ . A low charge transfer produces less offset error and permits the use of smaller hold capacitors for faster signal acquisition.
5. The AD582 provides separate analog and digital grounds, thus improving the device's immunity to ground and switching transients.

Information furnished by Analog Devices is believed to be accurate and reliable. However, no responsibility is assumed by Analog Devices for its use; nor for any infringements of patents or other rights of third parties which may result from its use. No license is granted by implication or otherwise under any patent or patent rights of Analog Devices.

**One Technology Way; Norwood, MA 02062-9106 U.S.A.**  
**Tel: 617/329-4700** **Twx: 710/394-6577**  
**Telex: 174059** **Cables: ANALOG NORWOODMASS**

# SPECIFICATIONS (typical @ +25°C, V<sub>S</sub> = ±15V and C<sub>H</sub> = 1000pF, A = +1 unless otherwise specified)

| MODEL   | AD582K               | AD582S                |
|---|----------------------|-----------------------|
| <b>SAMPLE/HOLD CHARACTERISTICS</b>  |                      |                       |
| Acquisition Time, 10V Step to 0.1%,<br>C <sub>H</sub> = 100pF                       | 6μs                  | *                     |
| Acquisition Time, 10V Step to 0.01%,<br>C <sub>H</sub> = 1000pF                     | 25μs                 | *                     |
| Aperture Time, 20V p-p Input,<br>Hold 0V  | 200ns                | *                     |
| Aperture Jitter, 20V p-p Input,<br>Hold 0V  | 15ns                 | *                     |
| Settling Time, 20V p-p Input,<br>Hold 0V, to 0.01%                                  | 0.5μs                | *                     |
| Droop Current, Steady State, ±10V <sub>OUT</sub>                                    | 100pA max            | 150nA max             |
| Droop Current, T <sub>min</sub> to T <sub>max</sub>                                 | 1nA                  | *                     |
| Charge Transfer   | 5pC max (1.5pC typ)  | *                     |
| Sample to Hold Offset   | 0.5mV                | *                     |
| Feedthrough Capacitance<br>20V p-p, 10kHz Input                                     | 0.05pF               | *                     |
| <b>TRANSFER CHARACTERISTICS</b>   |                      |                       |
| Open Loop Gain<br>V <sub>OUT</sub> = 20V p-p, R <sub>L</sub> = 2k                   | 25k min (50k typ)    | *                     |
| Common Mode Rejection<br>V <sub>CM</sub> = 20V p-p                                  | 60dB min (70dB typ)  | *                     |
| Small Signal Gain Bandwidth<br>V <sub>OUT</sub> = 100mV p-p, C <sub>H</sub> = 100pF | 1.5MHz               | *                     |
| Full Power Bandwidth<br>V <sub>OUT</sub> = 20V p-p, C <sub>H</sub> = 100pF          | 70kHz                | *                     |
| Slew Rate<br>V <sub>OUT</sub> = 20V p-p, C <sub>H</sub> = 100pF                     | 3V/μs                | *                     |
| Output Resistance<br>Hold Mode, I <sub>OUT</sub> = ±5mA                             | 12Ω                  | *                     |
| Linearity<br>V <sub>OUT</sub> = 20V p-p, R <sub>L</sub> = 2k                        | ±0.01%               | *                     |
| Output Short Circuit Current  | ±25mA                | *                     |
| <b>ANALOG INPUT CHARACTERISTICS</b>   |                      |                       |
| Offset Voltage  | 6mV max (2mV typ)    | *                     |
| Offset Voltage, T <sub>min</sub> to T <sub>max</sub>                                | 4mV                  | 8mV max (5mV typ)     |
| Bias Current  | 3μA max (1.5μA typ)  | *                     |
| Offset Current  | 300nA max (75nA typ) | *                     |
| Offset Current, T <sub>min</sub> to T <sub>max</sub>                                | 100nA                | 400nA max (100nA typ) |
| Input Capacitance, f = 1MHz   | 2pF                  | *                     |
| Input Resistance, Sample or Hold<br>20V p-p Input, A = +1                           | 30MΩ                 | *                     |
| Absolute Max Diff Input Voltage   | 30V                  | *                     |
| Absolute Max Input Voltage, Either Input  | ±V <sub>S</sub>      | *                     |
| <b>DIGITAL INPUT CHARACTERISTICS</b>  |                      |                       |
| +Logic Input Voltage  |                      |                       |
| Hold Mode, T <sub>min</sub> to T <sub>max</sub> , -Logic @ 0V                       | +2V min              | *                     |
| Sample Mode, T <sub>min</sub> to T <sub>max</sub> , -Logic @ 0V                     | +0.8V max            | *                     |
| +Logic Input Current  |                      |                       |
| Hold Mode, +Logic @ +5V, -Logic @ 0V  | 1.5μA                | *                     |
| Sample Mode, +Logic @ 0V, -Logic @ 0V   | 1nA                  | *                     |
| -Logic Input Current  |                      |                       |
| Hold Mode, +Logic @ +5V, -Logic @ 0V  | 24μA                 | *                     |
| Sample Mode, +Logic @ 0V, -Logic @ 0V   | 4μA                  | *                     |
| Absolute Max Diff Input Voltage, +L to -L   | +15V/-6V             | *                     |
| Absolute Max Input Voltage, Either Input  | ±V <sub>S</sub>      | *                     |
| <b>POWER SUPPLY CHARACTERISTICS</b>   |                      |                       |
| Operating Voltage Range   | ±9V to ±18V          | ±9V to ±22V           |
| Supply Current, R <sub>L</sub> = ∞  | 4.5mA max (3mA typ)  | *                     |
| Power Supply Rejection,<br>ΔV <sub>S</sub> = 5V, Sample Mode (see next page)        | 60dB min (75dB typ)  | *                     |
| <b>TEMPERATURE RANGE</b>  |                      |                       |
| Specified Performance   | 0 to +70°C           | -55°C to +125°C       |
| Operating   | -25°C to +85°C       | -55°C to +125°C       |
| Storage   | -65°C to +150°C      | *                     |
| Lead Temperature (Soldering, 15 sec)  | +300°C               | *                     |

## NOTES

\*Specifications same as AD582K.  
Specifications subject to change without notice.

## OUTLINE DIMENSIONS

Dimensions shown in inches and (mm).

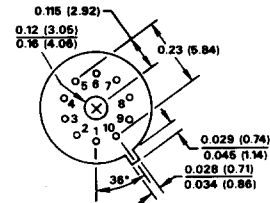
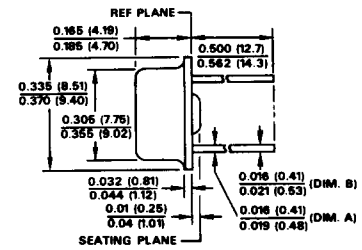

TO-100 "H"

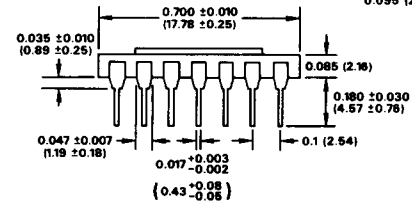
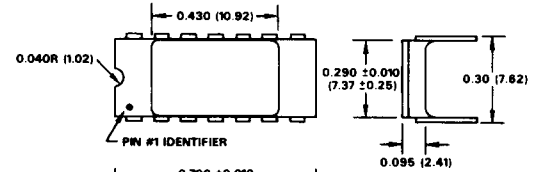

TO-116 "D"  
PIN CONFIGURATIONS  
TOP VIEW

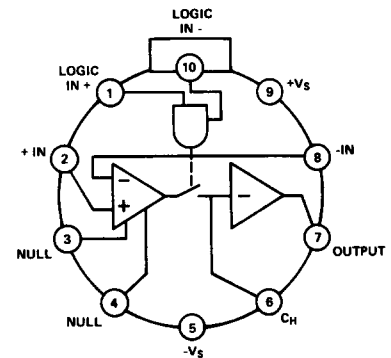

10 PIN TO-100

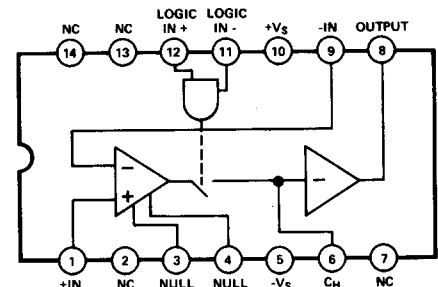

14 PIN DIP  
TO-116

## APPLYING THE AD582

Both the inverting and non-inverting inputs are brought out to allow op amp type versatility in connecting and using the AD582. Figure 1 shows the basic non-inverting unity gain connection requiring only an external hold capacitor and the usual power supply bypass capacitors. An offset null pot can be added for more critical applications.

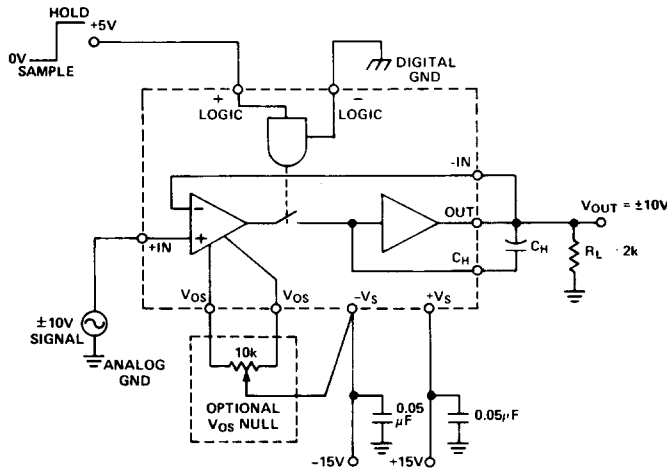

Figure 1. Sample and Hold with  $A = +1$

Figure 2 shows a non-inverting configuration where voltage gain,  $A_V$ , is set by a pair of external resistors. Frequency shaping or non-linear networks can also be used for special applications.

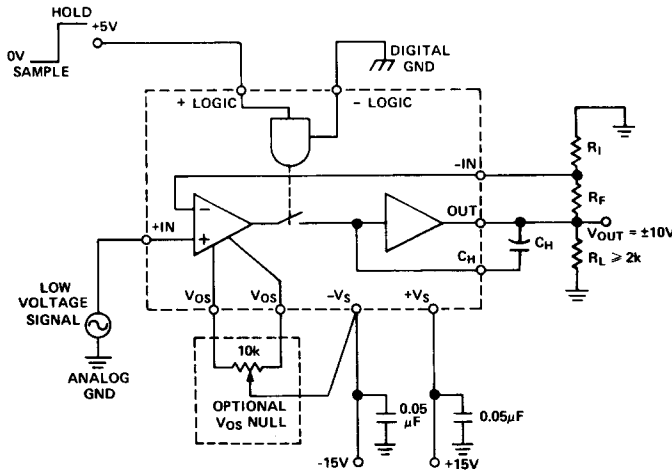

Figure 2. Sample and Hold with  $A = (1 + R_F/R_I)$

The hold capacitor,  $C_H$ , should be a high quality polystyrene (for temperatures below  $+85^\circ\text{C}$ ) or Teflon type with low dielectric absorption. For high speed, limited accuracy applications, capacitors as small as 100pF may be used. Larger values are required for accuracies of 12 bits and above in order to minimize feedthrough, sample to hold offset and droop errors (see Figure 6). Care should be taken in the circuit layout to minimize coupling between the hold capacitor and the digital or signal inputs.

In the hold mode, the output voltage will follow any change in the  $-V_S$  supply. Consequently, this supply should be well regulated and filtered.

Biasing the +Logic Input anywhere between  $-6\text{V}$  to  $+0.8\text{V}$  with respect to the -Logic will set the sample mode. The hold mode will result from any bias between  $+2.0\text{V}$  and  $(+V_S - 3\text{V})$ . The sample and hold modes will be controlled differentially with the absolute voltage at either logic input ranging from  $-V_S$  to within 3V of  $+V_S$  ( $V_S - 3\text{V}$ ). Figure 3 illustrates some examples of the flexibility of this feature.

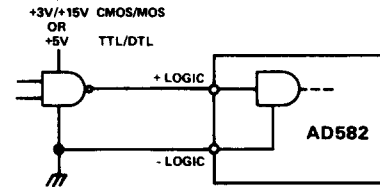

Figure 3A. Standard Logic Connection

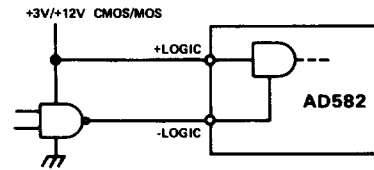

Figure 3B. Inverted Logic Sense Connection

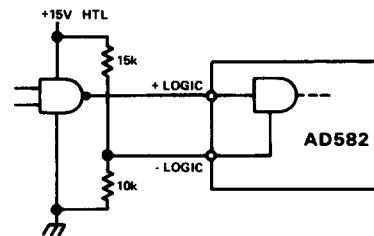

Figure 3C. High Threshold Logic Connection

## DEFINITION OF TERMS

Figure 4 illustrates various dynamic characteristics of the AD582.

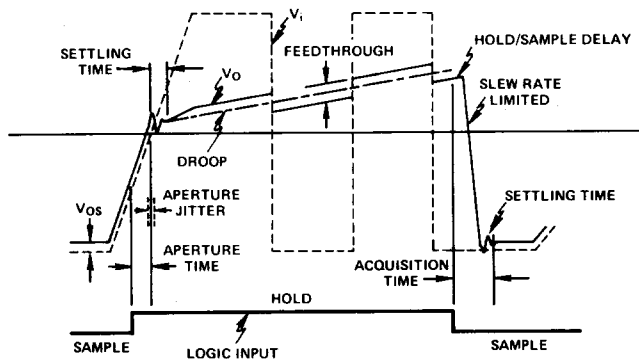

Figure 4. Pictorial Showing Various S/H Characteristics

**Aperture Time** is the time required after the "hold" command until the switch is fully open and produces a delay in the effective sample timing. Figure 5 is a plot giving the maximum frequency at which the AD582 can sample an input with a given accuracy (lower curve).

**Aperture Jitter** is the uncertainty in Aperture Time. If the Aperture Time is "tuned out" by advancing the sample-to-hold command 200ns with respect to the input signal, the Aperture Jitter now determines the maximum sampling frequency (upper curve of Figure 5).

**Acquisition Time** is the time required by the device to reach its final value within a given error band after the sample command has been given. This includes switch delay time, slewing time and settling time for a given output voltage change.

**Droop** is the change in the output voltage from the "held" value as a result of device leakage. In the AD582, droop can be in either the positive or negative direction. Droop rate may be calculated from droop current using the following formula:

$$\frac{\Delta V}{\Delta T} \text{ (Volts/sec)} = \frac{I \text{ (pA)}}{C_H \text{ (pF)}}$$

(See also Figure 6.)

**Feedthrough** is that component of the output which follows the input signal after the switch is open. As a percentage of the input, feedthrough is determined as the ratio of the feedthrough capacitance to the hold capacitance ( $C_F/C_H$ ).

**Charge Transfer** is the charge transferred to the holding capacitor from the interelectrode capacitance of the switch when the unit is switched to the hold mode. The charge transfer generates a sample-to-hold offset where:

$$\text{S/H Offset (V)} = \frac{\text{Charge (pC)}}{C_H \text{ (pF)}}$$

(See also Figure 6.)

**Sample-to-Hold Offset** is that component of D.C. offset independent of  $C_H$  (see Figure 6). This offset may be nulled using a null pot, however, the offset will then appear during the sampling mode.

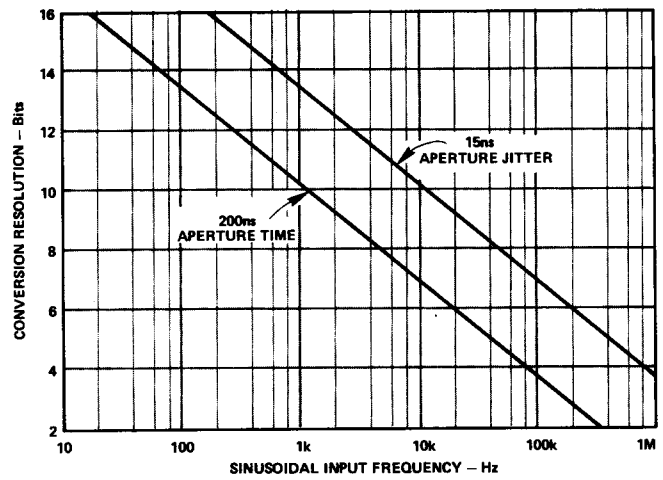

Figure 5. Maximum Frequency of Input Signal for 1/2 LSB Sampling Accuracy

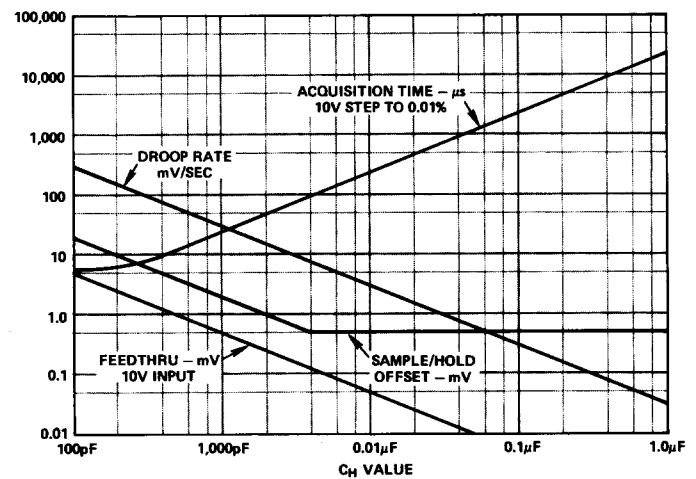

Figure 6. Sample-and-Hold Performance as a Function of Hold Capacitance

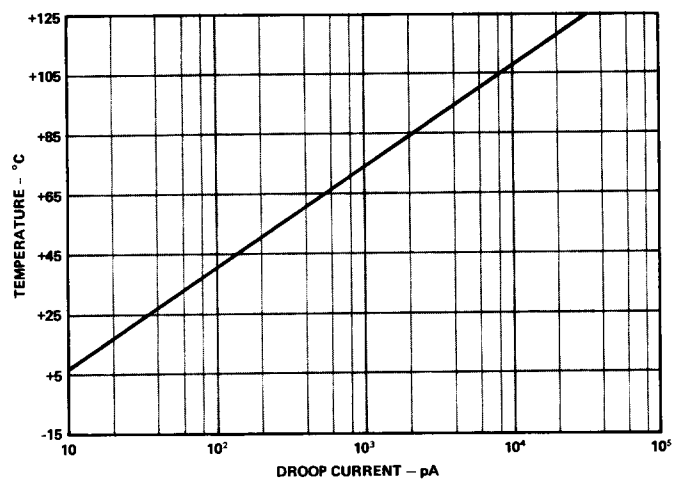

Figure 7. Droop Current vs. Temperature