

FEATURES
Ultralow power-down current: 150 nA/amplifier maximum
Low quiescent current: 2.4 mA/amplifier
High speed
175 MHz, -3 dB bandwidth
220 V/ μ s slew rate
85 ns settling time to 0.1%
Excellent video specifications
0.1 dB flatness: 14 MHz
Differential gain: 0.12%
Differential phase: 0.09°
Single-supply operation: 2.7 V to 6 V
Rail-to-rail output
Output swings to within 80 mV of either rail
Low voltage offset: 0.6 mV
APPLICATIONS
Portable multimedia players
Video cameras
Digital still cameras
Consumer video
Clock buffers
GENERAL DESCRIPTION

The ADA4850-1/ADA4850-2 are low price, high speed, voltage feedback rail-to-rail output op amps with ultralow power-down. Despite their low price, the ADA4850-1/ADA4850-2 provide excellent overall performance and versatility. The 175 MHz, -3 dB bandwidth and 220 V/ μ s slew rate make these amplifiers well-suited for many general-purpose, high speed applications.

The ADA4850-1/ADA4850-2 are designed to operate at supply voltages as low as 2.7 V and up to 6 V at 2.4 mA of supply current per amplifier. In power-down mode, the supply current is less than 150 nA, ideal for battery-powered applications.

The ADA4850-1/ADA4850-2 family provides users with a true single-supply capability, allowing input signals to extend 200 mV below the negative rail and to within 2.2 V of the positive rail. The output of the amplifier can swing within 80 mV of either supply rail.

With its combination of low price, excellent differential gain (0.12%), differential phase (0.09°), and 0.1 dB flatness out to 14 MHz, these amplifiers are ideal for video applications.

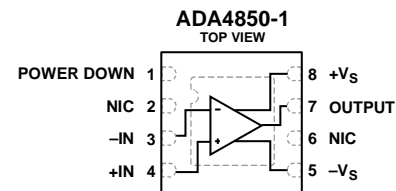
PIN CONFIGURATIONS

- NOTES**
1. EXPOSED PAD CAN BE CONNECTED TO GND, OR LEFT FLOATING.
 2. NIC = NO INTERNAL CONNECTION.

Figure 1. 8-Lead, 3 mm \times 3 mm LFCSP

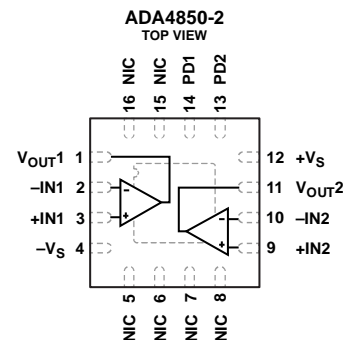

- NOTES**
1. EXPOSED PAD CAN BE CONNECTED TO GND, OR LEFT FLOATING.
 2. NIC = NO INTERNAL CONNECTION.

Figure 2. 16-Lead, 3 mm \times 3 mm LFCSP

The ADA4850-1/ADA4850-2 are designed to work in the extended temperature range of -40°C to +125°C.

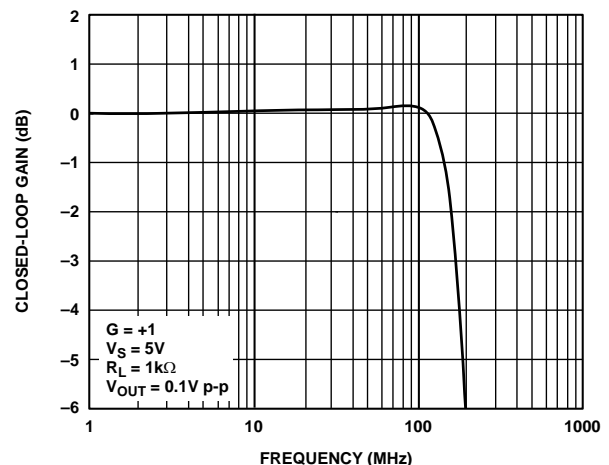

Figure 3. Small Signal Frequency Response

Rev. D
Document Feedback

Information furnished by Analog Devices is believed to be accurate and reliable. However, no responsibility is assumed by Analog Devices for its use, nor for any infringements of patents or other rights of third parties that may result from its use. Specifications subject to change without notice. No license is granted by implication or otherwise under any patent or patent rights of Analog Devices. Trademarks and registered trademarks are the property of their respective owners.

TABLE OF CONTENTS

Features 1
 Applications..... 1
 Pin Configurations 1
 General Description 1
 Revision History 2
 Specifications..... 3
 Specifications with +3 V Supply..... 3
 Specifications with +5 V Supply..... 4
 Absolute Maximum Ratings..... 5
 Thermal Resistance 5

ESD Caution.....5
 Typical Performance Characteristics6
 Circuit Description..... 12
 Headroom and Overdrive Recovery Considerations 12
 Operating the ADA4850-1/ADA4850-2 on Bipolar Supplies 13
 Power-Down Pins..... 13
 Outline Dimensions 14
 Ordering Guide 14

REVISION HISTORY

5/16—Rev. C to Rev. D

Change CP-8-2 to CP-8-13 and CP-16-3 to CP-16-21 ..Throughout
 Changes to Figure 1 and Figure 2..... 1
 Updated Outline Dimensions 14
 Changes to Ordering Guide 14

5/12—Rev. B to Rev. C

Added Exposed Pat Notation to Figure 1 and Figure 2..... 1
 Changes to Table 4 and Figure 4..... 5
 Added Exposed Pad Notation to Outline Dimensions 14
 Changes to Ordering Guide 14

12/07—Rev. A to Rev. B

Changes to Applications 1
 Updated Outline Dimensions 14
 Changes to Ordering Guide 14

4/05—Rev. 0 to Rev. A

Added ADA4850-1..... Universal
 Added 8-Lead LFCSP..... Universal
 Changes to Features1
 Changes to General Description1
 Changes to Figure 3.....1
 Changes to Table 1.....3
 Changes to Table 2.....4
 Changes to Power-Down Pins Section and Table 5..... 13
 Updated Outline Dimensions 14
 Changes to Ordering Guide 14

2/05—Revision 0: Initial Version

SPECIFICATIONS

SPECIFICATIONS WITH +3 V SUPPLY

$T_A = 25^\circ\text{C}$, $R_F = 0\ \Omega$ for $G = +1$, $R_F = 1\ \text{k}\Omega$ for $G > +1$, $R_L = 1\ \text{k}\Omega$, unless otherwise noted.

Table 1.

Parameter	Test Conditions/Comments	Min	Typ	Max	Unit
DYNAMIC PERFORMANCE					
-3 dB Bandwidth	$G = +1$, $V_O = 0.1\ \text{V p-p}$		160		MHz
	$G = +2$, $V_O = 0.5\ \text{V p-p}$, $R_L = 150\ \Omega$		45		MHz
Bandwidth for 0.1 dB Flatness	$G = +2$, $V_O = 0.5\ \text{V p-p}$, $R_L = 150\ \Omega$		14		MHz
Slew Rate	$G = +2$, $V_O = 1\ \text{V step}$		110		V/ μs
Settling Time to 0.1%	$G = +2$, $V_O = 1\ \text{V step}$, $R_L = 150\ \Omega$		80		ns
NOISE/DISTORTION PERFORMANCE					
Harmonic Distortion (dBc) HD2/HD3	$f_c = 1\ \text{MHz}$, $V_O = 2\ \text{V p-p}$, $G = +3$, $R_L = 150\ \Omega$		-72/-77		dBc
Input Voltage Noise	$f = 100\ \text{kHz}$		10		nV/ $\sqrt{\text{Hz}}$
Input Current Noise	$f = 100\ \text{kHz}$		2.5		pA/ $\sqrt{\text{Hz}}$
Differential Gain	$G = +3$, NTSC, $R_L = 150\ \Omega$, $V_O = 2\ \text{V p-p}$		0.2		%
Differential Phase	$G = +3$, NTSC, $R_L = 150\ \Omega$, $V_O = 2\ \text{V p-p}$		0.2		Degrees
DC PERFORMANCE					
Input Offset Voltage			0.6	4.1	mV
Input Offset Voltage Drift			4		$\mu\text{V}/^\circ\text{C}$
Input Bias Current			2.4	4.4	μA
Input Bias Current Drift			4		nA/ $^\circ\text{C}$
Input Bias Offset Current			30		nA
Open-Loop Gain	$V_O = 0.25\ \text{V to } 0.75\ \text{V}$	78	100		dB
INPUT CHARACTERISTICS					
Input Resistance	Differential/common-mode		0.5/5.0		M Ω
Input Capacitance			1.2		pF
Input Common-Mode Voltage Range			-0.2 to +0.8		V
Input Overdrive Recovery Time (Rise/Fall)	$V_{IN} = +3.5\ \text{V to } -0.5\ \text{V}$, $G = +1$		60/50		ns
Common-Mode Rejection Ratio	$V_{CM} = 0.5\ \text{V}$	-76	-108		dB
POWER-DOWN					
Power-Down Input Voltage	Power-down ADA4850-1/ADA4850-2 Enabled ADA4850-1/ADA4850-2		<0.7/<0.6 >0.8/>1.7		V
Turn-Off Time			0.7		μs
Turn-On Time			60		ns
Power-Down Bias Current/ Power Down Pin					
Enabled	Power-down = 3 V		37	55	μA
Power-Down	Power-down = 0 V		0.01	0.2	μA
OUTPUT CHARACTERISTICS					
Output Overdrive Recovery Time (Rise/Fall)	$V_{IN} = +0.7\ \text{V to } -0.1\ \text{V}$, $G = +5$		70/100		ns
Output Voltage Swing		0.06 to 2.83	0.03 to 2.92		V
Short-Circuit Current	Sinking/sourcing		105/74		mA
POWER SUPPLY					
Operating Range ¹		2.7		6	V
Quiescent Current/Amplifier			2.4	2.8	mA
Quiescent Current (Power-Down)/Amplifier			15	150	nA
Positive Power Supply Rejection	$+V_S = +3\ \text{V to } +4\ \text{V}$, $-V_S = 0\ \text{V}$	-83	-100		dB
Negative Power Supply Rejection	$+V_S = +3\ \text{V}$, $-V_S = 0\ \text{V to } -1\ \text{V}$	-83	-102		dB

¹ For operation on bipolar supplies, see the Operating the ADA4850-1/ADA4850-2 on Bipolar Supplies section.

SPECIFICATIONS WITH +5 V SUPPLY

$T_A = 25^\circ\text{C}$, $R_F = 0\ \Omega$ for $G = +1$, $R_F = 1\ \text{k}\Omega$ for $G > +1$, $R_L = 1\ \text{k}\Omega$, unless otherwise noted.

Table 2.

Parameter	Test Conditions/Comments	Min	Typ	Max	Unit
DYNAMIC PERFORMANCE					
-3 dB Bandwidth	$G = +1, V_O = 0.1\ \text{V p-p}$		175		MHz
	$G = +1, V_O = 0.5\ \text{V p-p}$		110		MHz
Bandwidth for 0.1 dB Flatness	$G = +2, V_O = 1.4\ \text{V p-p}, R_L = 150\ \Omega$		9		MHz
Slew Rate	$G = +2, V_O = 4\ \text{V step}$		220		V/ μs
	$G = +2, V_O = 2\ \text{V step}$		160		V/ μs
Settling Time to 0.1%	$G = +2, V_O = 1\ \text{V step}, R_L = 150\ \Omega$		85		ns
NOISE/DISTORTION PERFORMANCE					
Harmonic Distortion (dBc) HD2/HD3	$f_c = 1\ \text{MHz}, V_O = 2\ \text{V p-p}, G = +2, R_L = 150\ \Omega$		-81/-86		dBc
Input Voltage Noise	$f = 100\ \text{kHz}$		10		nV/ $\sqrt{\text{Hz}}$
Input Current Noise	$f = 100\ \text{kHz}$		2.5		pA/ $\sqrt{\text{Hz}}$
Differential Gain	$G = +3, \text{NTSC}, R_L = 150\ \Omega$		0.12		%
Differential Phase	$G = +3, \text{NTSC}, R_L = 150\ \Omega$		0.09		Degrees
Crosstalk (RTI)-ADA4850-2	$f = 4.5\ \text{MHz}, R_L = 150\ \Omega, V_O = 2\ \text{V p-p}$		60		dB
DC PERFORMANCE					
Input Offset Voltage			0.6	4.2	mV
Input Offset Voltage Drift			4		$\mu\text{V}/^\circ\text{C}$
Input Bias Current			2.3	4.2	μA
Input Bias Current Drift			4		nA/ $^\circ\text{C}$
Input Bias Offset Current			30		nA
Open-Loop Gain	$V_O = 2.25\ \text{V to } 2.75\ \text{V}$	83	105		dB
INPUT CHARACTERISTICS					
Input Resistance	Differential/common-mode		0.5/5.0		M Ω
Input Capacitance			1.2		pF
Input Common-Mode Voltage Range			-0.2 to +2.8		V
Input Overdrive Recovery Time (Rise/Fall)	$V_{IN} = +5.5\ \text{V to } -0.5\ \text{V}, G = +1$		50/40		ns
Common-Mode Rejection Ratio	$V_{CM} = 2.0\ \text{V}$	-85	-110		dB
POWER-DOWN					
Power-Down Input Voltage	Power-down ADA4850-1/ADA4850-2 Enabled ADA4850-1/ADA4850-2		<0.7/<0.6 >0.8/>1.7		V
Turn-Off Time			0.7		μs
Turn-On Time			50		ns
Power-Down Bias Current/Power Down Pin Enabled	Power-down = 5V		0.05	0.13	mA
Power-Down	Power-down = 0V		0.02	0.2	μA
OUTPUT CHARACTERISTICS					
Output Overdrive Recovery Time (Rise/Fall)	$V_{IN} = +1.1\ \text{V to } -0.1\ \text{V}, G = +5$		60/70		ns
Output Voltage Swing		0.14 to 4.83	0.07 to 4.92		V
Short-Circuit Current	Sinking/sourcing		118/94		mA
POWER SUPPLY					
Operating Range ¹		2.7		6	V
Quiescent Current/Amplifier			2.5	2.9	mA
Quiescent Current (Power-Down)/Amplifier			15	150	nA
Positive Power Supply Rejection	$+V_S = +5\ \text{V to } +6\ \text{V}, -V_S = 0\ \text{V}$	-84	-100		dB
Negative Power Supply Rejection	$+V_S = +5\ \text{V}, -V_S = -0\ \text{V to } -1\ \text{V}$	-84	-102		dB

¹ For operation on bipolar supplies, see the Operating the ADA4850-1/ADA4850-2 on Bipolar Supplies section.

ABSOLUTE MAXIMUM RATINGS

Table 3.

Parameter	Rating
Supply Voltage	12.6 V
Power Dissipation	See Figure 4
Power Down Pin Voltage	(-V _S + 6) V
Common-Mode Input Voltage Range	(-V _S - 0.5) V to (+V _S + 0.5) V
Differential Input Voltage Range	+V _S to -V _S
Storage Temperature Range	-65°C to +125°C
Operating Temperature Range	-40°C to +125°C
Lead Temperature Range (Soldering 10 sec)	300°C
Junction Temperature	150°C

Stresses at or above those listed under Absolute Maximum Ratings may cause permanent damage to the product. This is a stress rating only; functional operation of the product at these or any other conditions above those indicated in the operational section of this specification is not implied. Operation beyond the maximum operating conditions for extended periods may affect product reliability.

THERMAL RESISTANCE

θ_{JA} is specified for the worst-case conditions, that is, θ_{JA} is specified for the device soldered in the circuit board for surface-mount packages.

Table 4.

Package Type	θ _{JA}	Unit
16-Lead LFCSP	72.8	°C/W
8-Lead LFCSP	80	°C/W

Maximum Power Dissipation

The maximum safe power dissipation for the ADA4850-1/ADA4850-2 is limited by the associated rise in junction temperature (T_J) on the die. At approximately 150°C, which is the glass transition temperature, the plastic changes its properties. Even temporarily exceeding this temperature limit may change the stresses that the package exerts on the die, permanently shifting the parametric performance of the ADA4850-1/ADA4850-2. Exceeding a junction temperature of 150°C for an extended period of time can result in changes in silicon devices, potentially causing degradation or loss of functionality.

The power dissipated in the package (P_D) is the sum of the quiescent power dissipation and the power dissipated in the die due to the ADA4850-1/ADA4850-2 drive at the output. The quiescent power is the voltage between the supply pins (V_S) times the quiescent current (I_S).

$$P_D = \text{Quiescent Power} + (\text{Total Drive Power} - \text{Load Power})$$

$$P_D = (V_S \times I_S) + \left(\frac{V_S}{2} \times \frac{V_{OUT}}{R_L} \right) - \frac{V_{OUT}^2}{R_L}$$

Consider rms output voltages. If R_L is referenced to -V_S, as in single-supply operation, the total drive power is V_S × I_{OUT}. If the rms signal levels are indeterminate, consider the worst case, when V_{OUT} = V_S/4 for R_L to midsupply.

$$P_D = (V_S \times I_S) + \frac{(V_S/4)^2}{R_L}$$

In single-supply operation with R_L referenced to -V_S, the worst case is V_{OUT} = V_S/2.

Airflow increases heat dissipation, effectively reducing θ_{JA}. In addition, more metal directly in contact with the package leads and exposed paddle from metal traces through holes, ground, and power planes reduce θ_{JA}.

Figure 4 shows the maximum safe power dissipation in the package vs. the ambient temperature for the LFCSP (91°C/W) package on a JEDEC standard 4-layer board. θ_{JA} values are approximations.

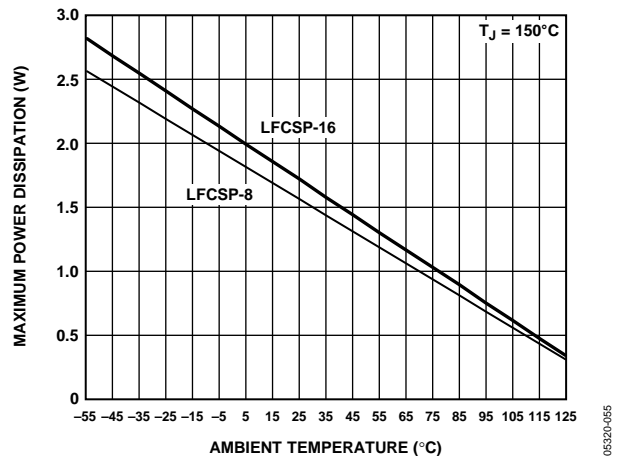

Figure 4. Maximum Power Dissipation vs. Temperature for a 4-Layer Board

ESD CAUTION



ESD (electrostatic discharge) sensitive device. Charged devices and circuit boards can discharge without detection. Although this product features patented or proprietary protection circuitry, damage may occur on devices subjected to high energy ESD. Therefore, proper ESD precautions should be taken to avoid performance degradation or loss of functionality.

TYPICAL PERFORMANCE CHARACTERISTICS

T_A = 25°C, R_F = 0 Ω for G = +1, R_F = 1 kΩ for G > +1, R_L = 1 kΩ, unless otherwise noted.

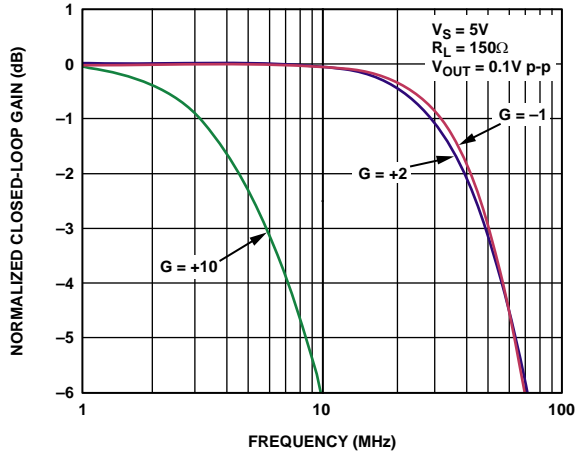

Figure 5. Small Signal Frequency Response for Various Gains

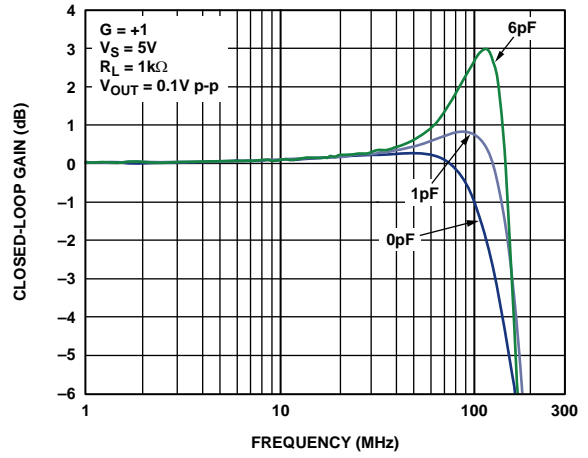

Figure 8. Small Signal Frequency Response for Various Capacitor Loads

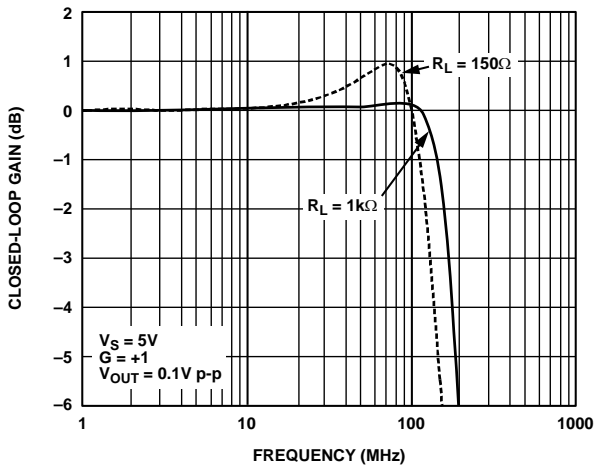

Figure 6. Small Signal Frequency Response for Various Loads

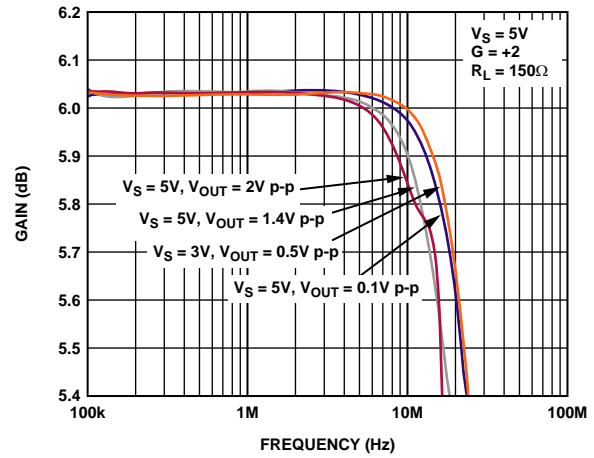

Figure 9. 0.1 dB Flatness Response

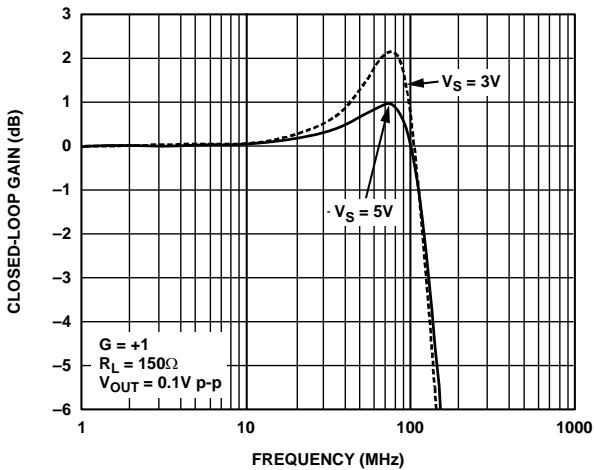

Figure 7. Small Signal Frequency Response for Various Supplies

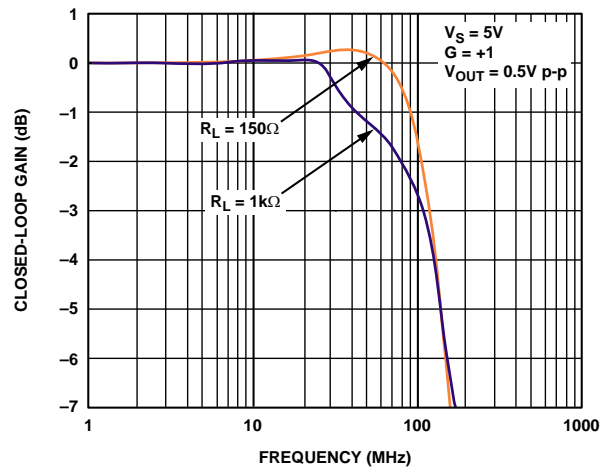

Figure 10. Large Frequency Response for Various Loads

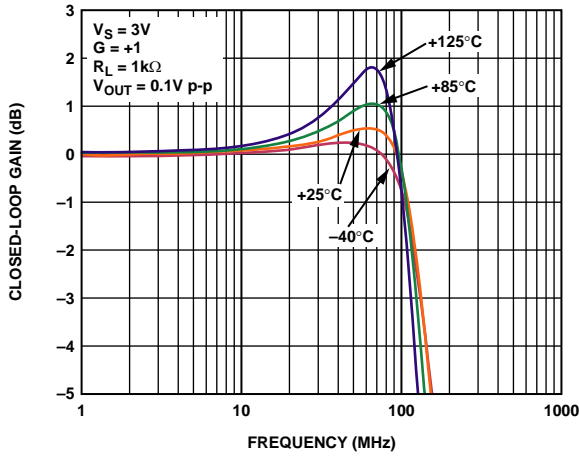

Figure 11. Small Signal Frequency Response for Various Temperatures

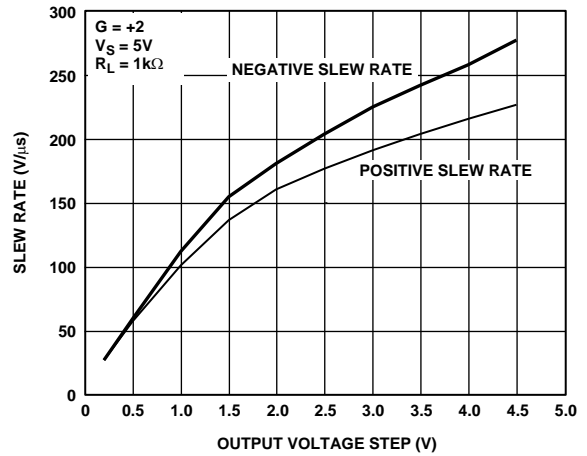

Figure 14. Slew Rate vs. Output Voltage

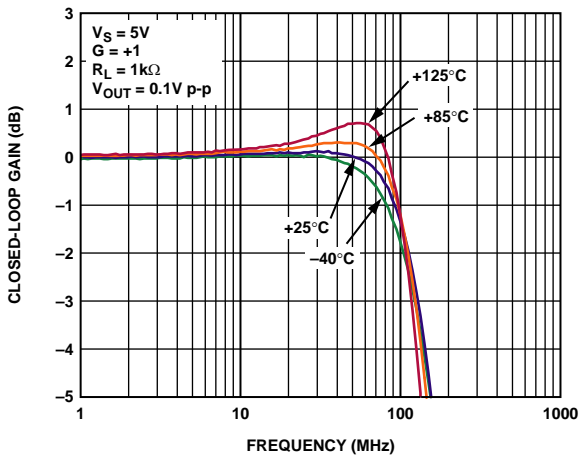

Figure 12. Small Signal Frequency Response for Various Temperatures

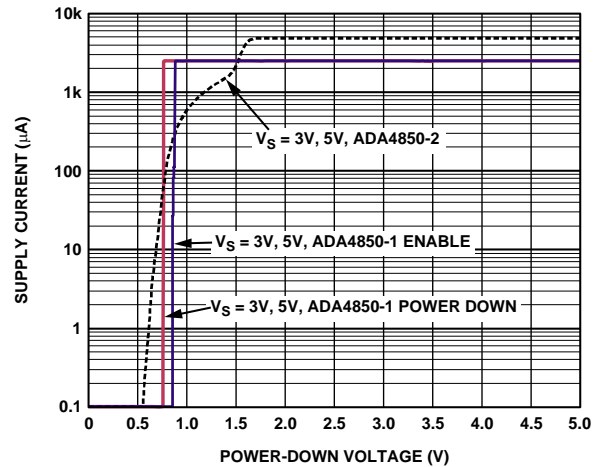

Figure 15. Supply Current vs. Power-Down Voltage

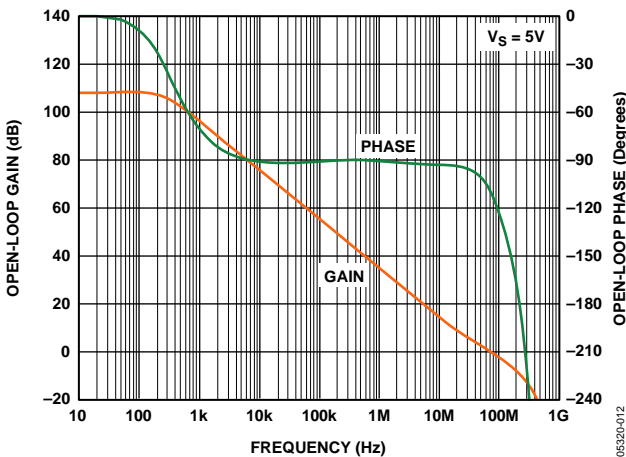

Figure 13. Open-Loop Gain and Phase vs. Frequency

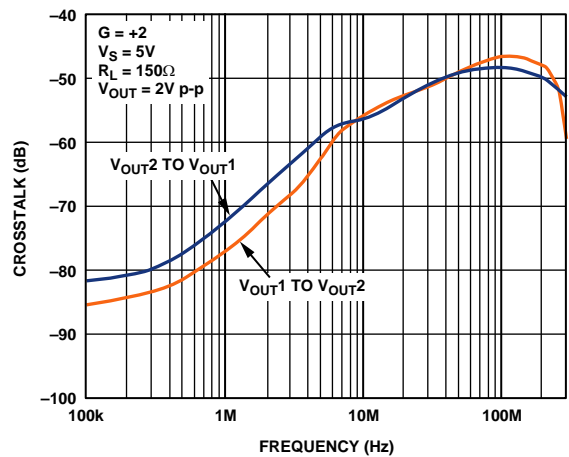

Figure 16. Crosstalk vs. Frequency

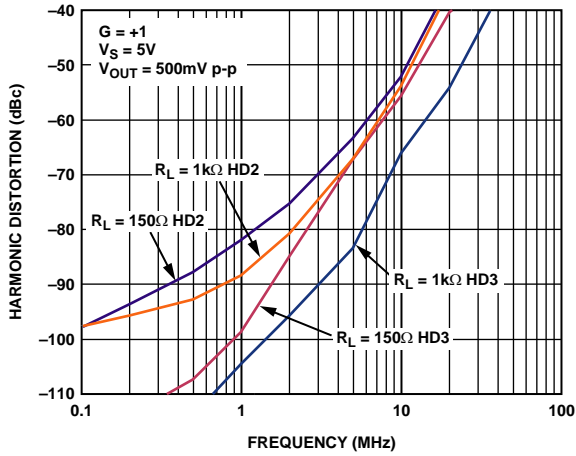

Figure 17. Harmonic Distortion vs. Frequency for Various Loads

05320-102

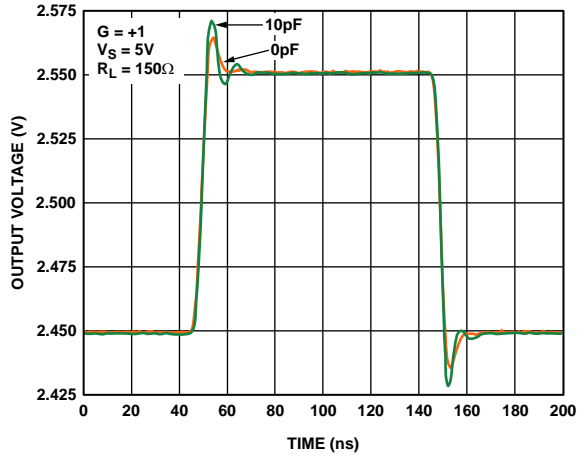

Figure 20. Small Signal Transient Response for Capacitive Load

05320-020

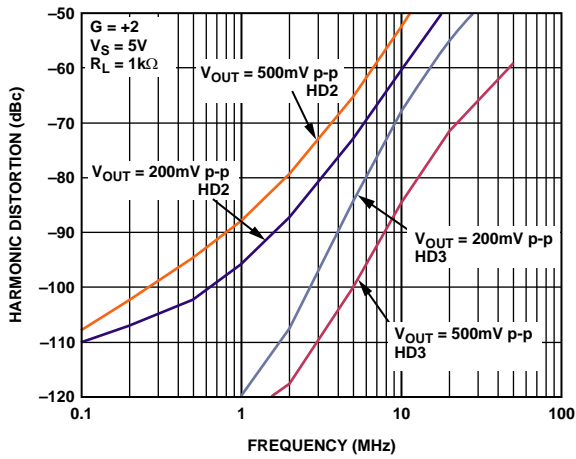

Figure 18. Harmonic Distortion vs. Frequency for Various V_{OUT}

05320-103

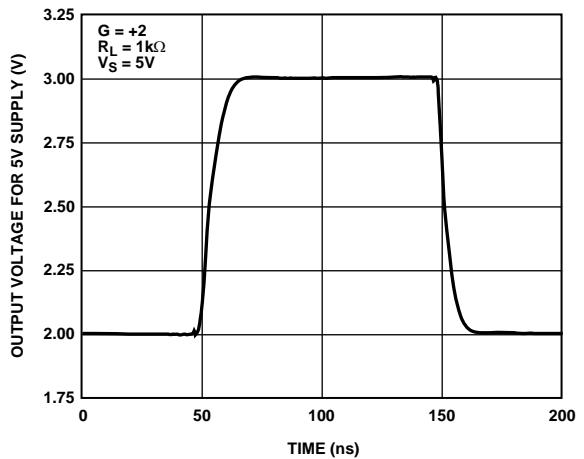

Figure 21. Large Signal Transient Response

05320-050

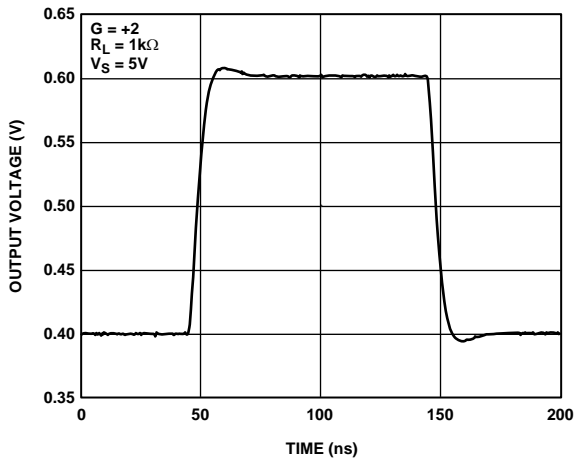

Figure 19. Small Signal Transient Response for Various Supplies

05320-019

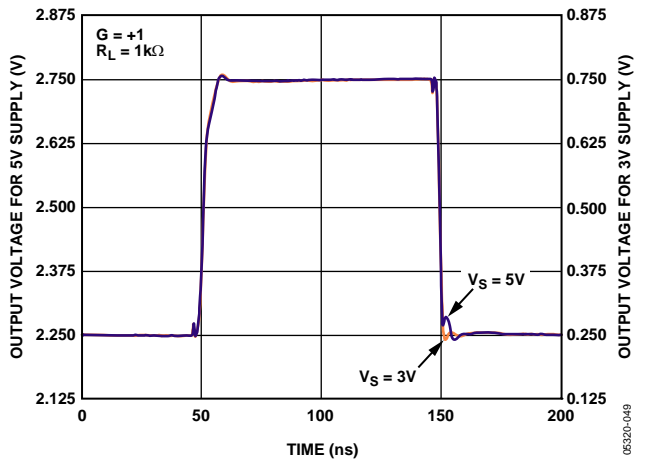

Figure 22. Large Signal Transient Response for Various Supplies

05320-049

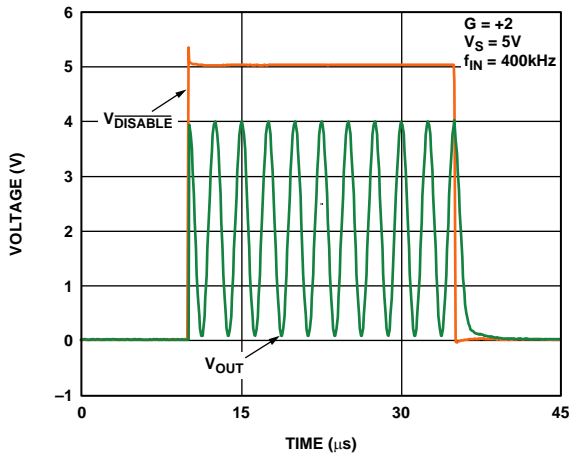

Figure 23. Enable/Disable Time

05320-025

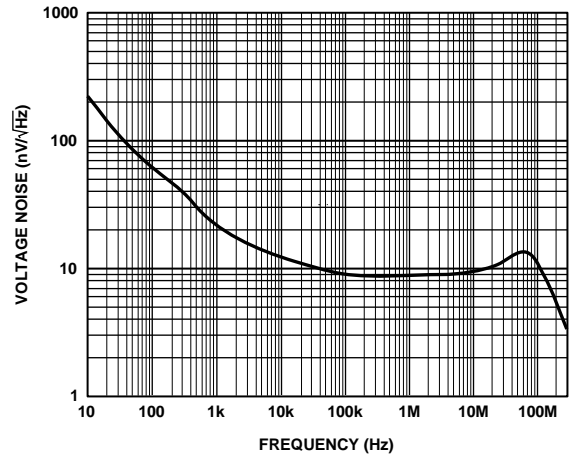

Figure 26. Voltage Noise vs. Frequency

05320-059

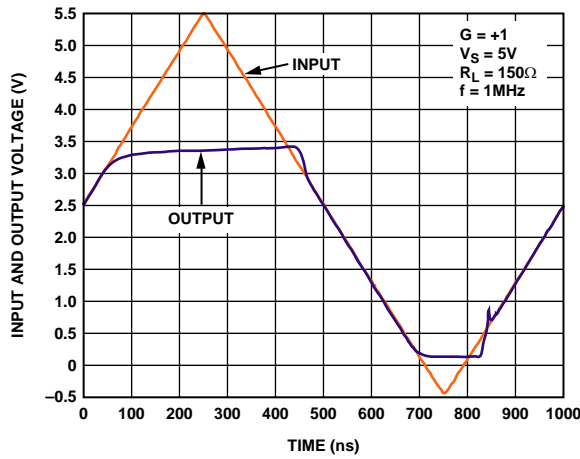

Figure 24. Input Overdrive Recovery

05320-058

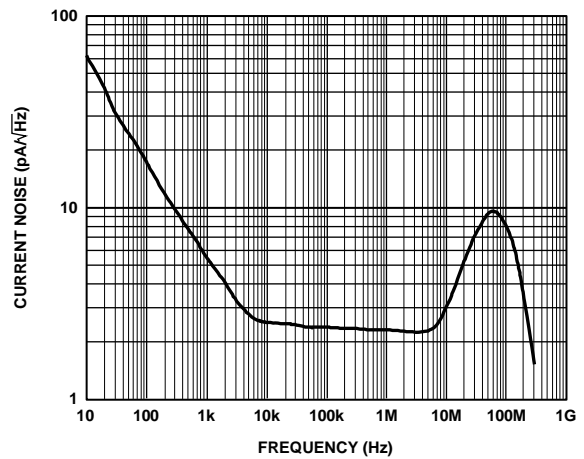

Figure 27. Current Noise vs. Frequency

05320-065

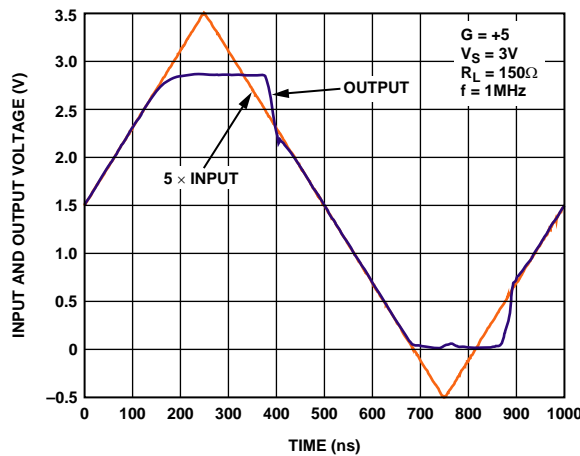

Figure 25. Output Overdrive Recovery

05320-060

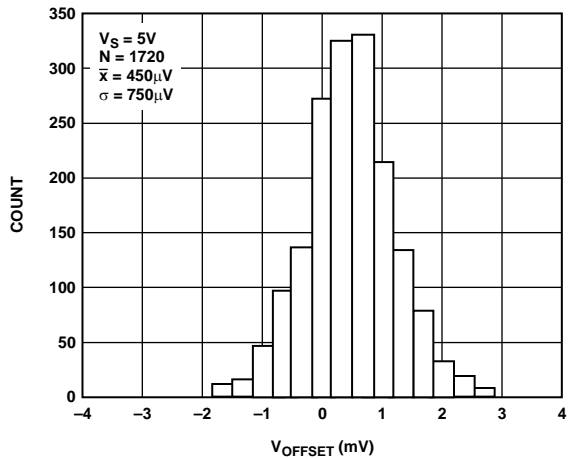

Figure 28. Input Offset Voltage Distribution

05320-065

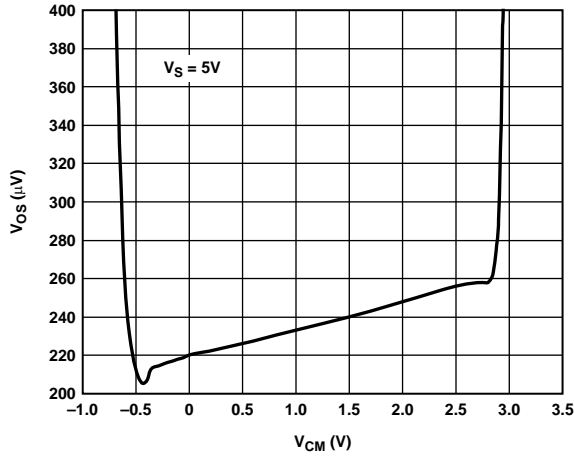

Figure 29. Input Offset Voltage vs. Common-Mode Voltage

05320-063

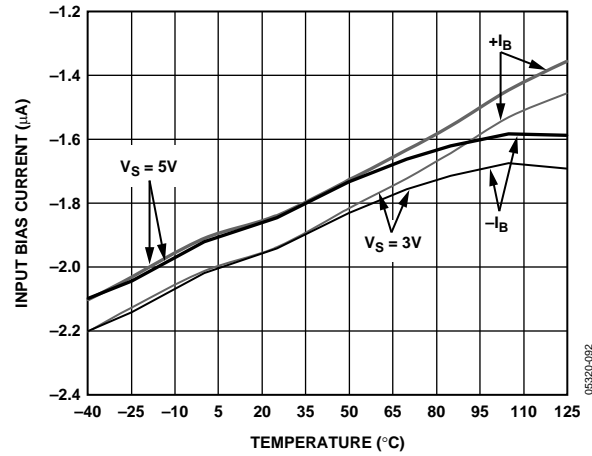

Figure 32. Input Bias Current vs. Temperature for Various Supplies

05320-092

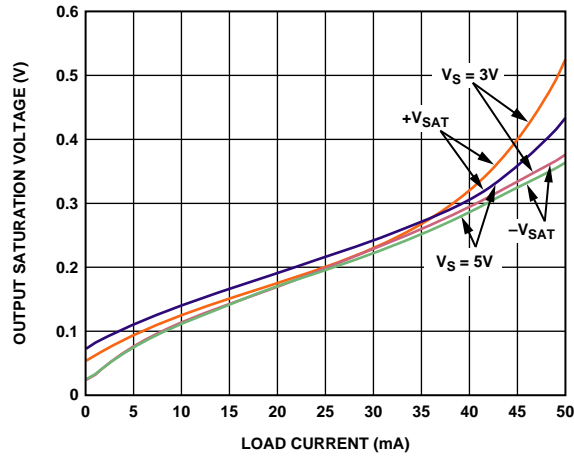

Figure 30. Output Saturation Voltage vs. Load Current (Voltage Differential from Rails)

05320-064

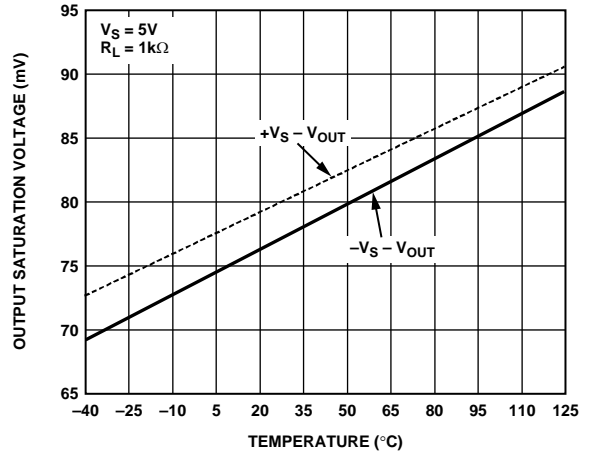

Figure 33. Output Saturation Voltage vs. Temperature (Voltage Differential from Rails)

05320-062

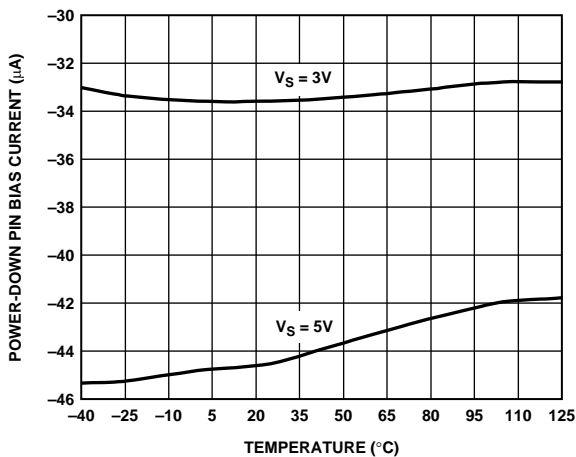

Figure 31. Power-Down Bias Current vs. Temperature for Various Supplies

05320-091

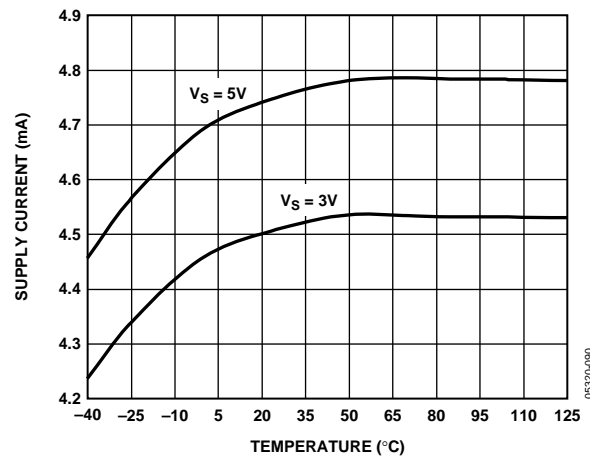

Figure 34. Current vs. Temperature for Various Supplies

05320-090

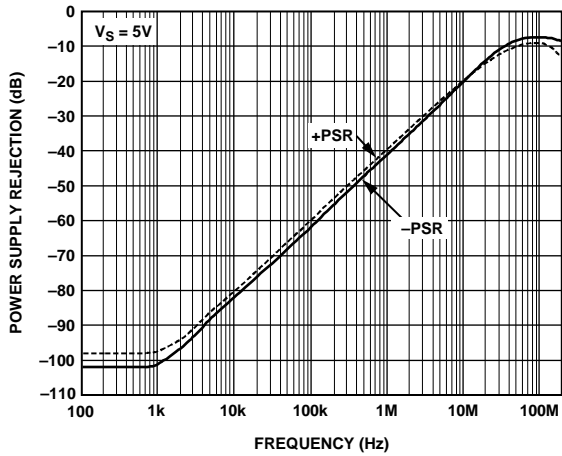

Figure 35. Power Supply Rejection (PSR) vs. Frequency

05320-094

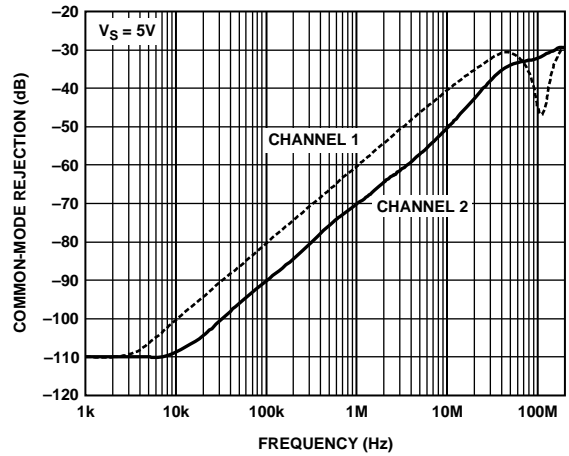

Figure 37. Common-Mode Rejection (CMR) vs. Frequency

05320-034

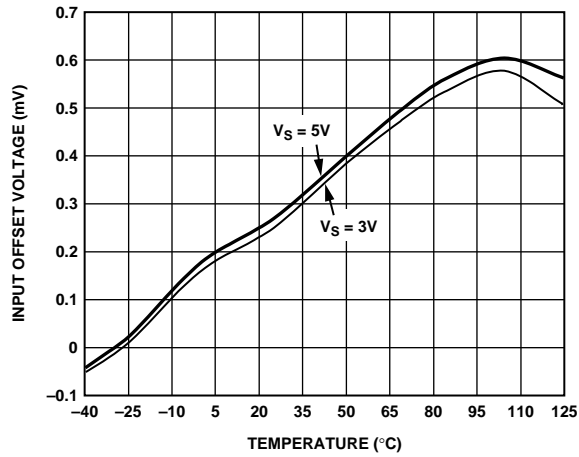

Figure 36. Input Offset Voltage vs. Temperature for Various Supplies

05320-093

CIRCUIT DESCRIPTION

The ADA4850-1/ADA4850-2 feature a high slew rate input stage that is a true single-supply topology, capable of sensing signals at or below the negative supply rail. The rail-to-rail output stage can swing to within 80 mV of either supply rail when driving light loads and within 0.17 V when driving 150 Ω. High speed performance is maintained at supply voltages as low as 2.7 V.

HEADROOM AND OVERDRIVE RECOVERY CONSIDERATIONS

Input

The ADA4850-1/ADA4850-2 are designed for use in low voltage systems. To obtain optimum performance, it is useful to understand the behavior of the amplifier as input and output signals approach the headroom limits of the amplifier. The input common-mode voltage range extends 200 mV below the negative supply voltage or ground for single-supply operation to within 2.2 V of the positive supply voltage. Therefore, in a gain of +3, the ADA4850-1/ADA4850-2 can provide full rail-to-rail output swing for supply voltage as low as 3.3 V, assuming the input signal swing is from $-V_S$ (or ground) to 1.1 V.

Exceeding the headroom limit is not a concern for any inverting gain on any supply voltage, as long as the reference voltage at the positive input of the amplifier lies within the input common-mode range of the amplifier.

The input stage sets the headroom limit for signals when the amplifier is used in a gain of +1 for signals approaching the positive rail. For high speed signals, however, there are other considerations. Figure 38 shows -3 dB bandwidth vs. dc input voltage for a unity-gain follower. As the common-mode voltage approaches the positive supply, the bandwidth begins to drop when within 2 V of $+V_S$. This can manifest itself in increased distortion or settling time.

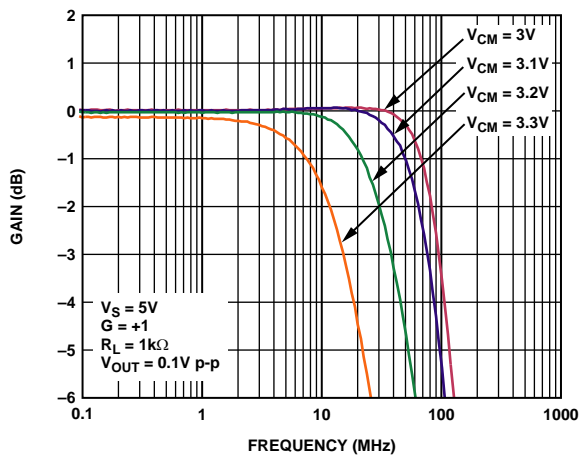

Figure 38. Unity-Gain Follower Bandwidth vs. Frequency for Various Input Common-Mode

Higher frequency signals require more headroom than the lower frequencies to maintain distortion performance. Figure 39 illustrates how the rising edge settling time for the amplifier configured as a unity-gain follower stretches out as the top of a 1 V step input approaches and exceeds the specified input common-mode voltage limit.

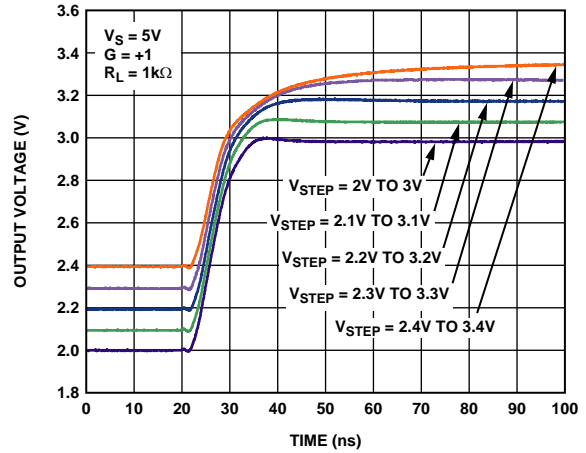

Figure 39. Pulse Response, Input Headroom Limits

The recovery time from input voltages 2.2 V or closer to the positive supply is approximately 50 ns, which is limited by the settling artifacts caused by transistors in the input stage coming out of saturation.

The ADA4850-1/ADA4850-2 do not exhibit phase reversal, even for input voltages beyond the voltage supply rails. Going more than 0.6 V beyond the power supplies turns on protection diodes at the input stage, which greatly increase the current draw of the devices.

Output

For signals approaching the negative supply and inverting gain, and high positive gain configurations, the headroom limit is the output stage. The ADA4850-1/ADA4850-2 amplifiers use a common-emitter output stage. This output stage maximizes the available output range, limited by the saturation voltage of the output transistors. The saturation voltage increases with drive current, due to the output transistor collector resistance.

As the saturation point of the output stage is approached, the output signal shows increasing amounts of compression and clipping. As in the input headroom case, higher frequency signals require a bit more headroom than the lower frequency signals.

Output overload recovery is typically within 40 ns after the input of the amplifier is brought to a nonoverloading value.

Figure 40 shows the output recovery transients for the amplifier recovering from a saturated output from the top and bottom supplies to a point at midsupply.

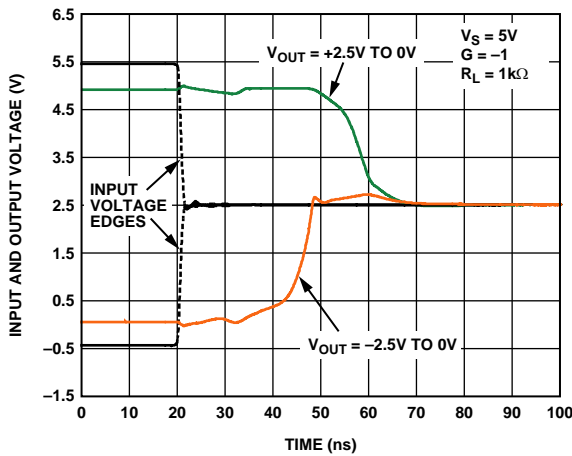

Figure 40. Overload Recovery

05320-042

OPERATING THE ADA4850-1/ADA4850-2 ON BIPOLAR SUPPLIES

The ADA4850-1/ADA4850-2 can operate on bipolar supplies up to ± 5 V. The only restriction is that the voltage between $-V_S$ and the POWER DOWN pin must not exceed 6 V. Voltage differences greater than 6 V can cause permanent damage to the amplifier. For example, when operating on ± 5 V supplies, the POWER DOWN pin must not exceed +1 V.

POWER-DOWN PINS

The ADA4850-1/ADA4850-2 feature an ultralow power-down mode that lowers the supply current to less than 150 nA. When a power-down pin is brought to within 0.6 V of the negative supply, the amplifier is powered down. Table 5 outlines the power-down pins functionality. To ensure proper operation, do not leave the power-down pins (PD1, PD2) floating.

Table 5. Power-Down Pins Functionality

Supply Voltage	3 V and 5 V	
	ADA4850-1	ADA4850-2
Power Down	0 V to 0.7 V	0 V to 0.6 V
Enabled	0.8 to $+V_S$	1.7 V to $+V_S$

OUTLINE DIMENSIONS

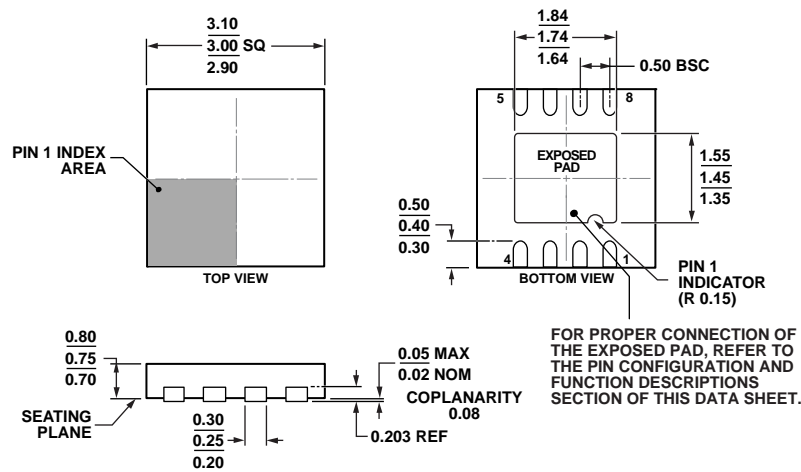

COMPLIANT TO JEDEC STANDARDS MO-229-WEED

Figure 41. 8-Lead Lead Frame Chip Scale Package [LFCSP]
3 mm × 3 mm Body and 0.75 mm Package Height
(CP-8-13)
Dimensions shown in millimeters

12-07-2010-A

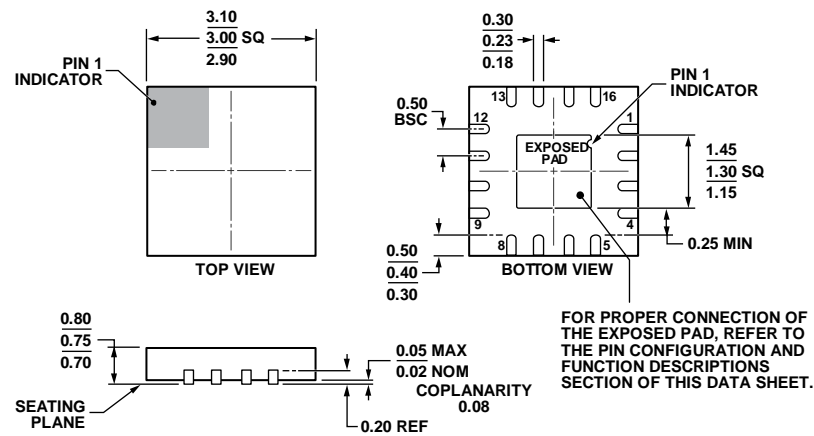

COMPLIANT TO JEDEC STANDARDS MO-220-WEED.

Figure 42. 16-Lead Lead Frame Chip Scale Package [LFCSP]
3 mm × 3 mm Body and 0.75 mm Package Height
(CP-16-21)
Dimensions shown in millimeters

111808-A

ORDERING GUIDE

Model ¹	Temperature Range	Package Description	Package Option	Branding
ADA4850-1YCPZ-RL7	-40°C to +125°C	8-Lead Lead Frame Chip Scale Package [LFCSP]	CP-8-13	HWB
ADA4850-2YCPZ-RL	-40°C to +125°C	16-Lead Lead Frame Chip Scale Package [LFCSP]	CP-16-21	HTB
ADA4850-2YCPZ-RL7	-40°C to +125°C	16-Lead Lead Frame Chip Scale Package [LFCSP]	CP-16-21	HTB
ADA4850-2YCP-EBZ		Evaluation Board for 16-Lead LFCP		

¹ Z = RoHS Compliant Part.