

FEATURES

- Monolithic CMOS
- Three-state outputs
- 12-Bit accuracy
- No missing codes
- Low cost
- Microprocessor-compatible

GENERAL DESCRIPTION

The ADC-ET series devices are low cost integrating A/D converters optimized for high accuracy, linearity and noise immunity. They operate at low power consumption, with sufficient speed to handle most industrial and instrumentation requirements. Discretely controlled three state outputs allow bus organized output connections making these units ideal for microprocessor interfacing.

Fabricated with monolithic CMOS techniques, each device is housed in a single 24 pin dual in-line package. The converter consists of an integrating operational amplifier, comparator, current switch, internal clock, two counters, latching output buffers and control logic circuitry. Operation of the circuit requires only a few external passive components and connection to external reference and power supplies. Conversion is accomplished by an incremental charge balancing technique which assures high linearity and noise immunity, along with inherent monotonicity resulting in no missing codes. At the completion of a conversion, the binary coded result appears in parallel form on discretely controlled latched outputs which are CMOS, low power TTL, or low power Schottky TTL compatible. The controllable outputs may be switched to a high impedance or off state by holding the ENABLE high.

Conversion times are 1.8, 6, and 24 milliseconds for the 8-, 10- and 12-bit units respectively. Other typical specifications include linearity to 1/4 LSB and a gain tempco of 25 ppm/°C. The analog input voltage range is programmable by means of an external resistor which sets the current into the integrator at 10 μ A full scale. Standard operating mode is unipolar but bipolar operation can be implemented by using an external operational amplifier to provide an offset current from the reference. Power requirement is ± 5 V dc at 2 mA which, for intermittent duty applications, may be reduced to only 200 μ A during standby periods without affecting data in the output latches.

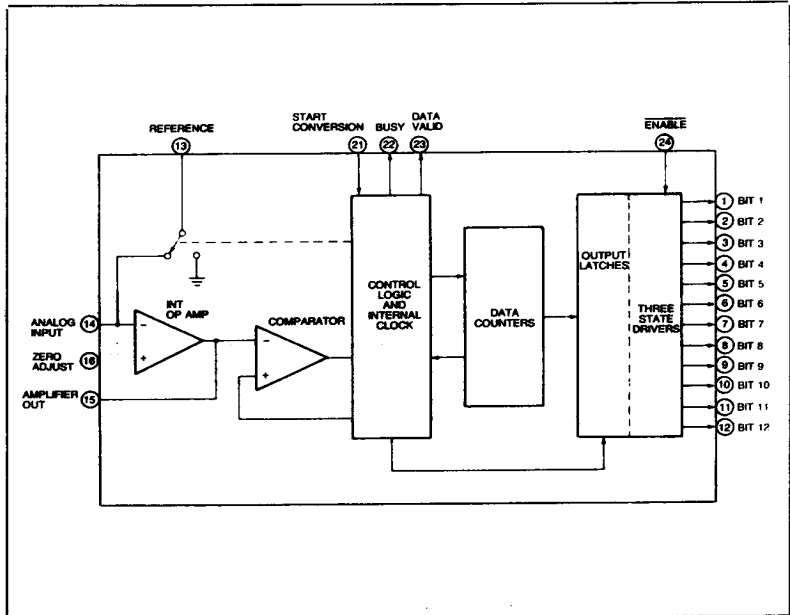

MECHANICAL DIMENSIONS INCHES (MM)

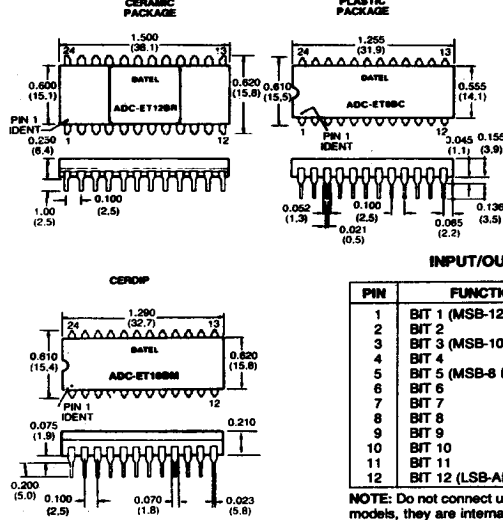

INPUT/OUTPUT CONNECTIONS

PIN	FUNCTION	PIN	FUNCTION
1	BIT 1 (MSB-12 BITS)	13	REFERENCE
2	BIT 2	14	ANALOG INPUT
3	BIT 3 (MSB-10 BITS)	14	AMPLIFIER OUT
4	BIT 4	16	ZERO ADJUST
5	BIT 5 (MSB-8 BITS)	17	BIAS
6	BIT 6	18	-5V POWER
7	BIT 7	19	+5V POWER
8	BIT 8	20	GROUND
9	BIT 9	20	START CONVERT
10	BIT 10	21	BUSY OUTPUT
11	BIT 11	23	DATA VALID
12	BIT 12 (LSB-ALL)	24	ENABLE

NOTE: Do not connect unused data output pins on 8- and 10-bit models, they are internally connected to the converter.

ABSOLUTE MAXIMUM RATINGS

I_{IN}	± 10 mA
I_{REF}	± 10 mA
Digital Input Voltage	-0.3V to $V_{DD} + 0.3V$
$V_{DD}-V_{SS}$	18V
Package Dissipation	500 mW

PHYSICAL/ENVIRONMENTAL

Operating Temperature Range	
C Suffix	-0°C to +70°C
R Suffix	-25°C to +85°C
M Suffix	-55°C to +125°C
Package	
C Suffix	24 Pin Plastic DIP
R & M Suffix	24 Pin Ceramic DIP

FOOTNOTES:

1. Nonlinearity for model ADC-ET12BC only is typically $\pm 1/4$ LSB, $\pm 1/2$ LSB maximum.
2. For M suffix units only gain tempco is typically 40 ppm/°C, 80 ppm/°C maximum and zero drift tempco is ± 80 $\mu V/^\circ C$.
3. $V_{DD} \pm 1V$, $V_{SS} \pm 1V$.
4. M suffix logic outputs can sink and source 500 μA .

FUNCTIONAL SPECIFICATIONS

Typical at 25°C, 5V Supplies, $R_{BIAS} = 100K$, unless otherwise noted.

ANALOG INPUTS

Type Analog Input	Single-Ended
Input Current Range	0 to +10 μA
Reference Current	-20 μA

DIGITAL INPUTS

Logical "1" V_{IN}	3.5V minimum
Logical "0" V_{IN}	1.5V maximum
Start Convert Pulse Width	500 nanoseconds minimum
ENABLE Propagation Delay	500 nanoseconds

OUTPUTS

Output Off State Current	0.1 μA typical, ± 10 μA maximum
Logic "1" Output Voltage	+4.5V minimum at -10 μA
	+2.4V minimum at -360 μA^4
Logic "0" Output Voltage	+0.4V maximum at 360 μA^4
Data Valid Output	High for Data Valid, Low When Loading
Busy Output	High During Conversion

PERFORMANCE

Resolution	8, 10, 12 Bits
Coding, Unipolar	Straight Binary
Bipolar	Offset Binary
Conversion Times	
8 Bits	1.8 milliseconds maximum
10 Bits	6 milliseconds maximum
12 Bits	24 milliseconds maximum
Nonlinearity	$\pm 1/4$ LSB typical, $\pm 1/2$ LSB maximum ¹
Differential Nonlinearity	$\pm 1/4$ LSB typical, $\pm 1/2$ LSB maximum
Diff. Nonlinearity Tempco	± 2.5 ppm/°C
No Missing Codes	Over Operating Temp. Range
Initial Gain Error, (Adj. to Zero)	$\pm 5\%$ maximum
Gain Temperature Coefficient	± 25 ppm/°C typical, ± 75 ppm/°C maximum ²
Initial Zero Error (Adj. to Zero)	± 50 mV maximum
Zero Drift Tempco	± 50 $\mu V/^\circ C$ maximum ²
Power Supply Sensitivity	$\pm 0.05\%/%$ maximum ³

POWER REQUIREMENTS

Voltage, Rated Performance	$\pm 5V$ dc
Voltage Range, Operating	$\pm 3.5V$ dc to $\pm 7V$ dc
Supply Quiescent Current	
C Suffix	± 5.0 mA maximum
R Suffix	± 2.5 mA maximum
M Suffix	± 3.5 mA maximum

TECHNICAL NOTES

1. The ADC-ET series are CMOS devices and must be properly handled to prevent damage due to static discharge. Proper anti-static precautions should be taken, including storage and transport in anti-static containers or conductive foam, and grounding of work stations, handling equipment and personnel. Do not connect in circuits under "power on" conditions. The input voltage should be applied after power is on. Do not open the circuitry for the zero adjust, reference or start convert pins while the power is on. It should be noted that the top and bottom of the ceramic package are connected to the positive supply.
2. Nominal values of input, reference and offset resistors are given in the resistor table. Due to the possible $\pm 5\%$ tolerance of the external reference and the $+5\%$, -3% tolerance of the converter scale factor, the actual resistor value can vary by almost $\pm 10\%$. R_G and R_T in the diagrams are for trimming gain and bipolar offset during calibration. It is recommended that R_G be 1% of R_{IN} (nominal) and that R_T be 1% of R_{OFF} (nominal). They should both be 100 ppm/°C cermet trimming pots. The recommended procedure for selecting R_{IN} and R_{OFF} is set to R_G and R_T to the center of their ranges and choose a 1% metal film resistor which gives the closest fit at the full scale point 1111...111 for R_{IN} and one that gives the closest fit to the zero scale point 0000...000 for R_T .
3. The temperature stability of the ADC-ET converters depends directly on the converter itself, R_{IN} , R_{REF} , R_{OFF} and V_{REF} . Since the converter is typically ± 25 ppm/°C it is recommended that a 10 ppm/°C reference be used along with 10 ppm/°C metal film resistors for R_{IN} , R_{REF} and R_{OFF} for best performance over temperature.
4. Passive components used with the converter may have tolerances as indicated here: C_C is a $\pm 20\%$ ceramic capacitor; C_{INT} is a $\pm 10\%$ glass or ceramic capacitor; R_{C1} , R_{BIAS} and the two zero adjust resistors are $\pm 10\%$ carbon composition type.
5. It is recommended that two 0.1 μF bypass capacitors be used at the power supply pins as shown in the connection diagram. C_{INT} should be connected as close as possible to pins 14 and 15 and as far as possible from any noisy lines.
6. Logic signals should not be routed under these devices or near the input, reference or zero adjust pins.
7. All digital outputs will drive two low power TTL loads or one low power Schottky TTL load. The outputs should not be overloaded as this will affect the performance of the converter.

TECHNICAL NOTES (Cont'd)

8. It should be noted that there is a propagation delay of approximately 500 nanoseconds between the time ENABLE changes state and the time that the outputs change state.
9. Two's complement coding can be implemented by inverting the MSB signal.
10. I_{IN} and I_{REF} pins 14 and 13 respectively, connect to the summing junction of an operational amplifier which requires a current input. Voltage sources cannot be attached directly to them, but must be buffered by external resistors. Refer to Test Circuit Diagrams. Analog input can be any positive voltage when applied through the proper scaling resistor.
11. Conversion accuracy is directly dependent on V_{REF} . In order to avoid degrading accuracy, V_{REF} voltage regulation must be $\pm 0.04\%$ for 8-bit models, $\pm 0.01\%$ for 10-bit models and $\pm 0.0025\%$ for 12-bit models.

TIMING DIAGRAMS

CLOCKED OPERATION

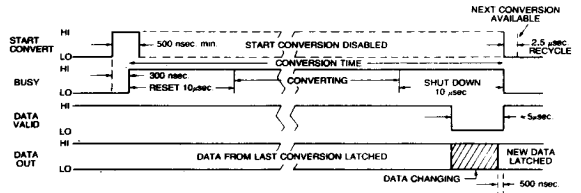

FREE RUNNING OPERATION

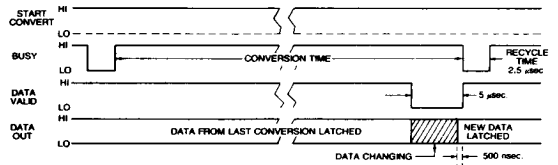

START CONVERT (PIN 21) IS TIED TO +5V dc (PIN 19)

DESCRIPTION OF OPERATION

When the START CONVERT input is strobed with a positive pulse of at least 500 nanoseconds duration, the busy line latches high and a start up cycle of approximately 10 microseconds begins, during which the integrating capacitor is discharged and both counters are reset. Conversion begins at the end of an internal reset pulse.

During conversion, the sum of a continuous current, I_{IN} and pulses of an inversely signed reference current I_{REF} , is integrated. I_{IN} is proportional to the analog input voltage and I_{REF} is proportional to the reference voltage. A pulse of I_{REF} is applied as required to maintain the summing input of the integrating operational amplifier near zero. The total number of pulses of I_{REF} required to maintain the summing input near zero is counted and the binary coded result is latched into the outputs at the end of conversion.

The end of conversion is signaled by a pulse generated by the clock counter or by the data counter when an overflow condition occurs; this pulse disables further inputs into both counters and begins a 10 microseconds shutdown cycle. During the shutdown cycle, Data Valid goes low for 5 microseconds, while the result of the latest conversion is being transferred to the outputs. Until transfer is complete, the data at the outputs is not valid. At the end of the shutdown cycle, Data Valid goes high indicating that the outputs are latched with the result of the last conversion, and the Busy Output goes low indicating the completion of the conversion cycle and the availability of the converter for the next conversion.

When the converter is employed in a free-running mode, the START CONVERT input is held high (simply connect pin 21 to pin 19), the Busy Output will go low for approximately 2.5 microseconds to mark the completion and initiation of consecutive conversion cycles. It should be noted that once conversion is initiated, the cycle cannot be interrupted; the START CONVERT pin is disabled when the Busy Output is high, and thus its logic state has no effect until completion of the conversion cycle. After the completion of a conversion, the output data remains valid for as long as power is applied to the circuit, or until Data Valid goes low at the end of a conversion.

CODING TABLES

STRAIGHT BINARY

SCALE	8 BIT		10 BIT		12 BIT	
	0 TO +10V	CODE	0 TO +10V	CODE	0 TO +10V	CODE
FS-1 LSB	+9.96V	1111 1111	+9.990V	11 1111 1111	+9.9976V	1111 1111 1111
1/2 FS	+5.00	1000 0000	+5.000	10 0000 0000	+5.0000	1000 0000 0000
1LSB	+0.04	0000 0001	+0.010	00 0000 0001	+0.0024	0000 0000 0001
0	0.00	0000 0000	0.000	00 0000 0000	0.0000	0000 0000 0000

OFFSET BINARY

SCALE	8 BIT		10 BIT		12 BIT	
	$\pm 5V$	CODE	$\pm 5V$	CODE	$\pm 5V$	CODE
+FS-1 LSB	+4.96V	1111 1111	+4.990V	11 1111 1111	+4.9976V	1111 1111 1111
0	0.00	1000 0000	0.000	10 0000 0000	0.0000	1000 0000 0000
-FS + 1 LSB	-4.96	0000 0001	-4.990	00 0000 0001	-4.9976	0000 0000 0001
-FS	-5.00	0000 0000	-5.000	00 0000 0000	-5.0000	0000 0000 0000

RESISTOR TABLES

UNIPOLAR RANGE	BIPOLAR RANGE	R_{IN} (NOMINAL)
0 TO +2V	$\pm 1V$	200K
0 TO +5V	$\pm 2.5V$	500K
0 TO +10V	$\pm 5V$	1 MEG
0 TO +20V	$\pm 10V$	2 MEG

V_{REF}	R_{REF} (NOMINAL)	R_{OFF} (NOMINAL)
-1.22V	61K	244K
-2.5V	125K	500K
-6.4V	320K	1.28 MEG.

CONNECTIONS AND CALIBRATION

CONNECTION FOR UNIPOLAR OPERATION

R_{IN} , R_{REF} ARE 1% METAL FILM RESISTORS.
 R_{BIAS} , R_1 ARE 10% CARBON COMP RESISTORS.
 C_2 & 20% CERAMIC CAPACITOR.
 ZERO ADJUSTMENT RESISTORS ARE 10% CARBON COMP.
 ALL TRIMMING POTS ARE 100 ppm/°C CERMET TYPE.
 SUPPLY BYPASS CAPACITORS ARE CERAMIC OR TANTALUM.
 C_{INT} IS 10% GLASS OR CERAMIC CAPACITOR.

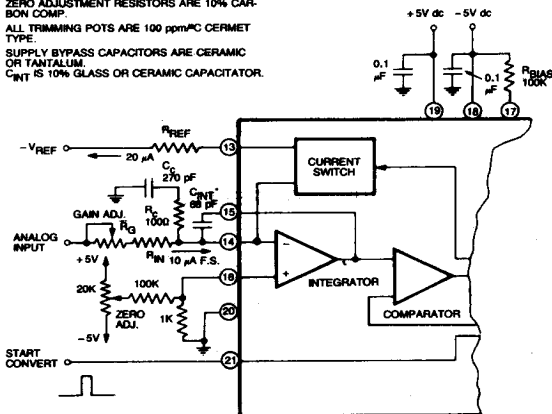

*33 pF FOR ADC-ET86C

CONNECTION FOR BIPOLAR OPERATION

R_{IN} , R_{REF} ARE 1% METAL FILM RESISTORS.
 R_{BIAS} , R_1 ARE 10% CARBON COMP RESISTORS.
 C_2 & 20% CERAMIC CAPACITOR.
 ZERO ADJUSTMENT RESISTORS ARE 10% CARBON COMP.
 ALL TRIMMING POTS ARE 100 ppm/°C CERMET TYPE.
 SUPPLY BYPASS CAPACITORS ARE CERAMIC OR TANTALUM.
 C_{INT} IS 10% GLASS OR CERAMIC CAPACITOR.

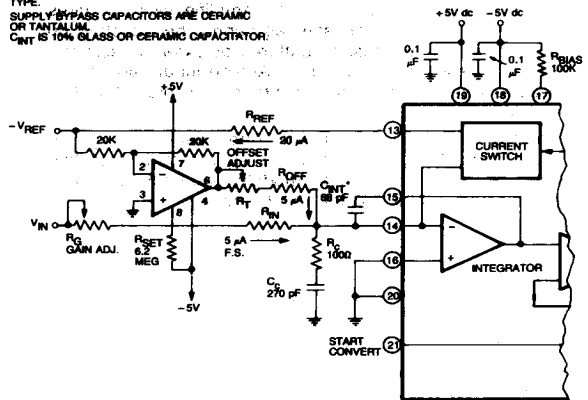

*33 pF FOR ADC-ET86C

REDUCTION OF STAND-BY POWER

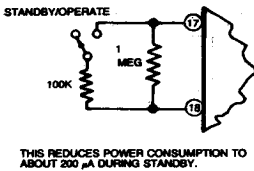

REFERENCE CIRCUITS

1.22V BAND GAP REFERENCE USES EXISTING -5V SUPPLY

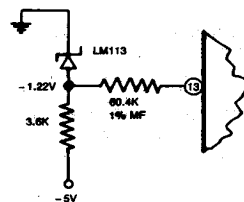

6.4V ZENER REFERENCE REQUIRES -15V SUPPLY

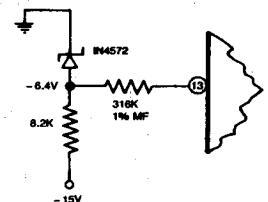

CALIBRATION PROCEDURE

1. Connect the converter as shown in the connection diagrams for either unipolar or bipolar operation. Determine the input voltage range and select the required input resistors. Apply a logic high to the start convert input (pin 21) to give free-running operation.
2. **Zero and Offset Adjustments.** Apply a precision voltage reference source from the analog input resistor to ground. Adjust the reference source to zero + 1/2 LSB for unipolar operation or - FS + 1/2 LSB for bipolar operation. Adjust the zero or offset potentiometer so that the output code flickers between 000 . . . 000 and 000 . . . 001.
3. **Gain Adjustment.** Set the output of the reference source to + FS - 1/2 LSB and adjust the gain trimming potentiometer so that the output code just flickers between 111 . . . 110 and 111 . . . 111.

LOW COST MICROPROCESSOR A/D, D/A INTERFACE

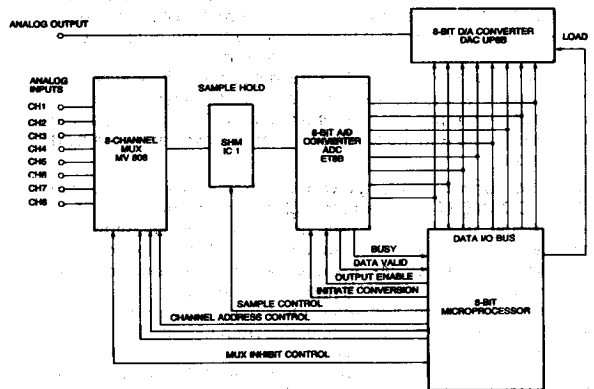

TYPICAL PERFORMANCE CURVES

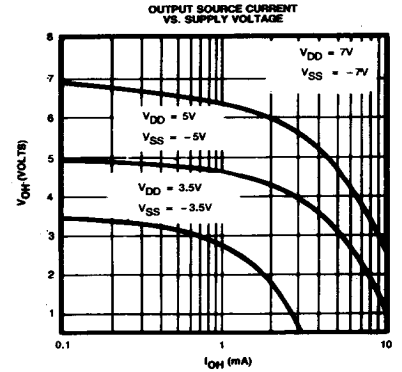
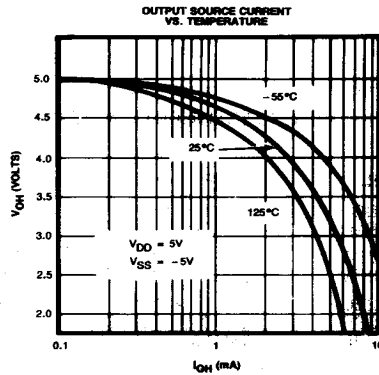
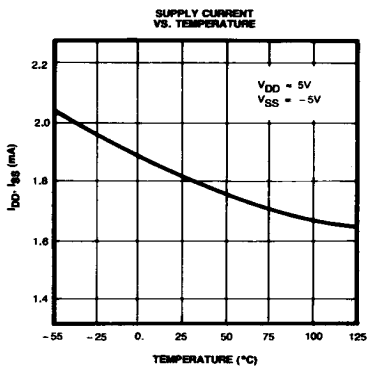
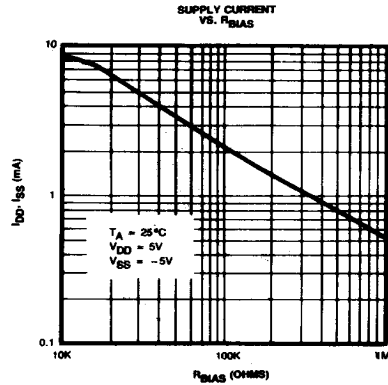
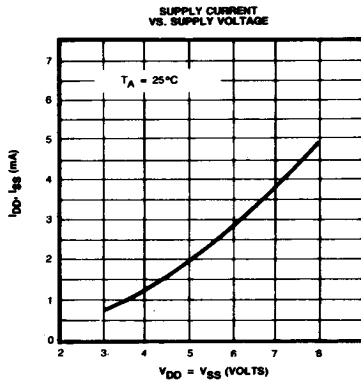
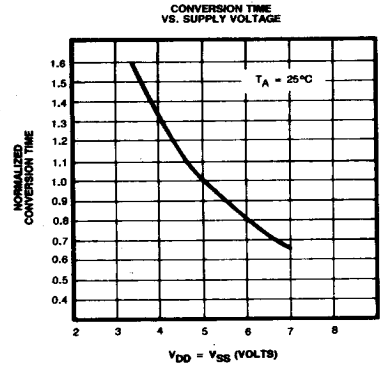
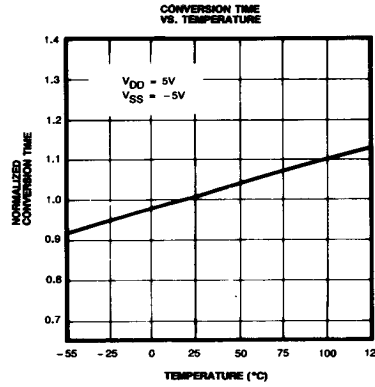
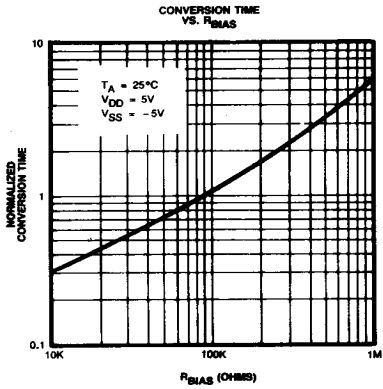

TYPICAL PERFORMANCE CURVES

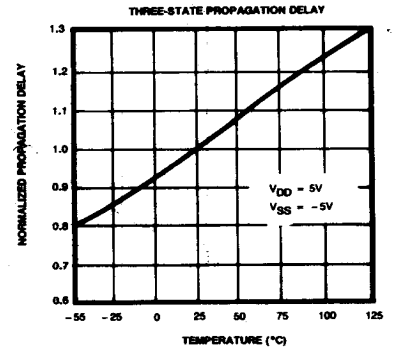
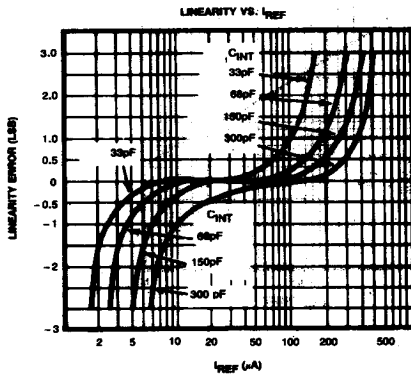
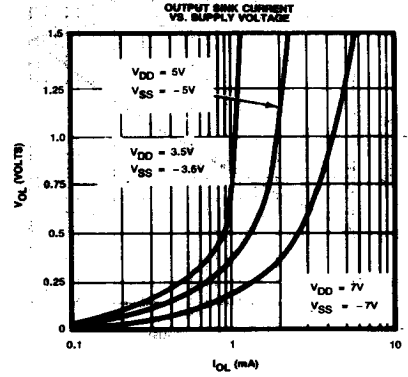
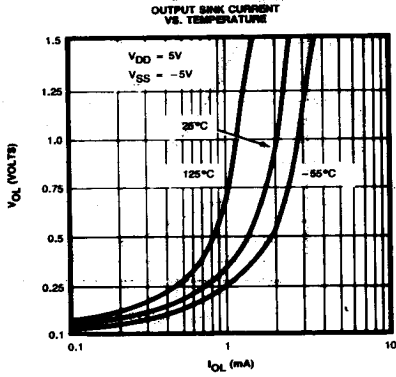

ORDERING INFORMATION

MODEL	OPERATING TEMP. RANGE	PACKAGE
ADC-ET8BC	0°C to +70°C	Plastic
ADC-ET8BM	-55°C to +125°C	Cer dip.
ADC-ET10BC	0°C to +70°C	Plastic
ADC-ET10BM	-55°C to +125°C	Cer dip.
ADC-ET12BC	0°C to +70°C	Plastic
ADC-ET12BF	-25°C to +85°C	Ceramic
ADC-ET12BM	-55°C to +125°C	Ceramic