

### FEATURES

- Alternative to the ADM1021
- On-Chip and Remote Temperature Sensing
- No Calibration Necessary
- 1°C Accuracy for On-Chip Sensor
- 3°C Accuracy for Remote Sensor
- Programmable Overtemperature/Undertemperature Limits
- Programmable Conversion Rate
- 2-Wire SMBus Serial Interface
- Supports System Management Bus (SMBus) Alert
- 200 mA Max Operating Current
- 1 mA Standby Current
- 3 V to 5.5 V Supply
- Small 16-Lead QSOP Package

### APPLICATIONS

- Desktop Computers
- Notebook Computers
- Smart Batteries
- Industrial Controllers
- Telecom Equipment
- Instrumentation

### PRODUCT DESCRIPTION

The ADM1021A is a two-channel digital thermometer and undertemperature/overtemperature alarm, intended for use in personal computers and other systems requiring thermal monitoring and management. The device can measure the temperature of a microprocessor using a diode-connected PNP transistor, which may be provided on-chip in the case of the Pentium® III or similar processors, or can be a low-cost discrete NPN/PNP device such as the 2N3904/2N3906. A novel measurement technique cancels out the absolute value of the transistor's base emitter voltage, so that no calibration is required. The second measurement channel measures the output of an on-chip temperature sensor, to monitor the temperature of the device and its environment.

The ADM1021A communicates over a two-wire serial interface compatible with SMBus standards. Undertemperature and overtemperature limits can be programmed into the devices over the serial bus, and an **ALERT** output signals when the on-chip or remote temperature is out of range. This output can be used as an interrupt, or as an SMBus alert.

### FUNCTIONAL BLOCK DIAGRAM

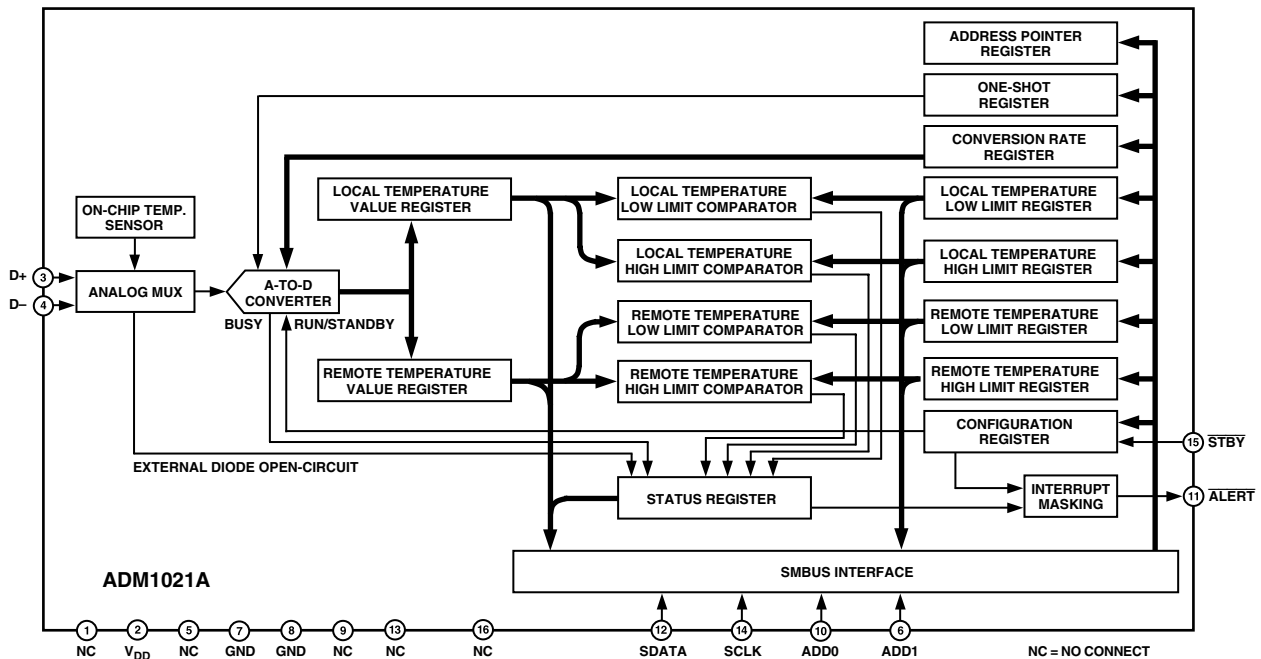

\*Patents Pending

REV. D

Information furnished by Analog Devices is believed to be accurate and reliable. However, no responsibility is assumed by Analog Devices for its use, nor for any infringements of patents or other rights of third parties that may result from its use. No license is granted by implication or otherwise under any patent or patent rights of Analog Devices. Trademarks and registered trademarks are the property of their respective owners.

# ADM1021A—SPECIFICATIONS ( $T_A = T_{MIN}$ to $T_{MAX}$ <sup>1</sup>, $V_{DD} = 3.0\text{ V}$ to $3.6\text{ V}$ , unless otherwise noted.)

Parameter	Min	Typ	Max	Unit	Test Conditions/Comments
<b>POWER SUPPLY AND ADC</b>					
Temperature Resolution	1			°C	Guaranteed No Missed Codes
Temperature Error, Local Sensor		±1		°C	
	-3		+3	°C	
Temperature Error, Remote Sensor	-3		+3	°C	$T_A = 60^\circ\text{C}$ to $100^\circ\text{C}$
	-5		+5	°C	
Supply Voltage Range	3		3.6	V	Note 2
Undervoltage Lockout Threshold	2.5	2.7	2.95	V	$V_{DD}$ Input, Disables ADC, Rising Edge
Undervoltage Lockout Hysteresis		25		mV	
Power-On Reset Threshold	0.9	1.7	2.2	V	$V_{DD}$ , Falling Edge <sup>3</sup>
POR Threshold Hysteresis		50		mV	
Standby Supply Current		1	5	µA	$V_{DD} = 3.3\text{ V}$ , No SMBus Activity
		4		µA	SCLK at 10 kHz
Average Operating Supply Current		130	200	µA	0.25 Conversions/Sec Rate
Autoconvert Mode, Averaged Over 4 Seconds		225	330	µA	2 Conversions/Sec Rate
Conversion Time	65	115	170	ms	From Stop Bit to Conversion Complete (Both Channels)
					D+ Forced to D- + 0.65 V
Remote Sensor Source Current	120	205	300	µA	High Level <sup>3</sup>
	7	12	16	µA	Low Level <sup>3</sup>
D-Source Voltage		0.7		V	
Address Pin Bias Current (ADD0, ADD1)		50		µA	Momentary at Power-On Reset
<b>SMBUS INTERFACE</b>					
Logic Input High Voltage, $V_{IH}$ STBY, SCLK, SDATA	2.2			V	$V_{DD} = 3\text{ V}$ to $5.5\text{ V}$
Logic Input Low Voltage, $V_{IL}$ STBY, SCLK, SDATA			0.8	V	$V_{DD} = 3\text{ V}$ to $5.5\text{ V}$
SMBus Output Low Sink Current	6			mA	SDATA Forced to 0.6 V
ALERT Output Low Sink Current	1			mA	ALERT Forced to 0.4 V
Logic Input Current, $I_{IH}$ , $I_{IL}$	-1		+1	µA	
SMBus Input Capacitance, SCLK, SDATA		5		pF	
SMBus Clock Frequency			100	kHz	
SMBus Clock Low Time, $t_{LOW}$	4.7			µs	$t_{LOW}$ between 10% Points
SMBus Clock High Time, $t_{HIGH}$	4			µs	$t_{HIGH}$ between 90% Points
SMBus Start Condition Setup Time, $t_{SU:STA}$	4.7			µs	
SMBus Repeat Start Condition Setup Time, $t_{SU:STA}$	250			ns	Between 90% and 90% Points
SMBus Start Condition Hold Time, $t_{HD:STA}$	4			µs	Time from 10% of SDATA to 90% of SCLK
SMBus Stop Condition Setup Time, $t_{SU:STO}$	4			µs	Time from 90% of SCLK to 10% of SDATA
SMBus Data Valid to SCLK Rising Edge Time, $t_{SU:DAT}$	250			ns	Time from 10% or 90% of SDATA to 10% of SCLK
SMBus Data Hold Time, $t_{HD:DAT}$	0			µs	
SMBus Bus Free Time, $t_{BUF}$	4.7			µs	Between Start/Stop Conditions
SCLK Falling Edge to SDATA Valid Time, $t_{VD, DAT}$			1	µs	Master Clocking in Data

## NOTES

<sup>1</sup> $T_{MAX} = 100^\circ\text{C}$ ;  $T_{MIN} = 0^\circ\text{C}$ .

<sup>2</sup>Operation at  $V_{DD} = 5\text{ V}$  guaranteed by design, not production tested.

<sup>3</sup>Guaranteed by design, not production tested.

Specifications subject to change without notice.

### ABSOLUTE MAXIMUM RATINGS\*

Positive Supply Voltage ( $V_{DD}$ ) to GND	-0.3 V to +6 V
D+, ADD0, ADD1	-0.3 V to $V_{DD} + 0.3$ V
D- to GND	-0.3 V to +0.6 V
SCLK, SDATA, $\overline{\text{ALERT}}$ , $\overline{\text{STBY}}$	-0.3 V to +6 V
Input Current	$\pm 50$ mA
Input Current, D-	$\pm 1$ mA
ESD Rating, All Pins (Human Body Model)	2000 V
Continuous Power Dissipation	
Up to 70°C	650 mW
Derating above 70°C	6.7 mW/°C
Operating Temperature Range	-55°C to +125°C
Maximum Junction Temperature ( $T_J$ max)	150°C
Storage Temperature Range	-65°C to +150°C
Lead Temperature, (Soldering 10 sec)	300°C
IR Reflow Peak Temperature	220°C

\*Stresses above those listed under Absolute Maximum Ratings may cause permanent damage to the device. This is a stress rating only; functional operation of the device at these or any other conditions above those indicated in the operational section of this specification is not implied. Exposure to absolute maximum rating conditions for extended periods may affect device reliability.

### THERMAL CHARACTERISTICS

16-Lead QSOP Package:  $\theta_{JA} = 150^\circ\text{C}/\text{W}$ .

### PIN FUNCTION DESCRIPTIONS

Pin No.	Mnemonic	Description
1, 5, 9, 13, 16	NC	No Connect
2	$V_{DD}$	Positive Supply, 3 V to 5.5 V
3	D+	Positive Connection to Remote Temperature Sensor
4	D-	Negative Connection to Remote Temperature Sensor
6	ADD1	Three-State Logic Input, Higher Bit of Device Address
7, 8	GND	Supply 0 V Connection
10	ADD0	Three-State Logic Input, Lower Bit of Device Address
11	$\overline{\text{ALERT}}$	Open-Drain Logic Output Used as Interrupt or SMBus Alert
12	SDATA	Logic Input/Output, SMBus Serial Data. Open-Drain Output.
14	SCLK	Logic Input, SMBus Serial Clock
15	$\overline{\text{STBY}}$	Logic Input Selecting Normal Operation (High) or Standby Mode (Low)

### ORDERING GUIDE

Model	Temperature Range	Package Description	Package Option
ADM1021AARQ	0°C to 100°C	16-Lead QSOP	RQ-16
ADM1021AARQ-REEL	0°C to 100°C	16-Lead QSOP	RQ-16
ADM1021AARQ-REEL7	0°C to 100°C	16-Lead QSOP	RQ-16
ADM1021AARQZ*	0°C to 100°C	16-Lead QSOP	RQ-16
ADM1021AARQZ-REEL*	0°C to 100°C	16-Lead QSOP	RQ-16
ADM1021AARQZ-REEL7*	0°C to 100°C	16-Lead QSOP	RQ-16
EVAL-ADM1021AEB		Evaluation Board	

\* Z = Pb-Lead free

### PIN CONFIGURATION

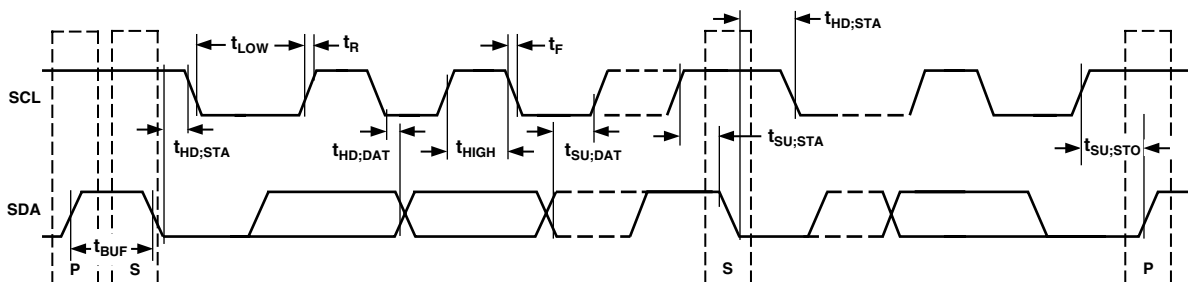
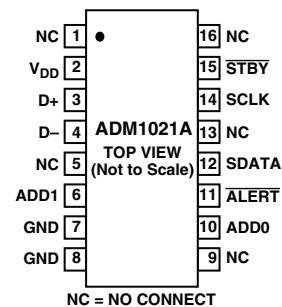

Figure 1. Diagram for Serial Bus Timing

### CAUTION

ESD (electrostatic discharge) sensitive device. Electrostatic charges as high as 4000 V readily accumulate on the human body and test equipment and can discharge without detection. Although the ADM1021A features proprietary ESD protection circuitry, permanent damage may occur on devices subjected to high energy electrostatic discharges. Therefore, proper ESD precautions are recommended to avoid performance degradation or loss of functionality.



# ADM1021A—Typical Performance Characteristics

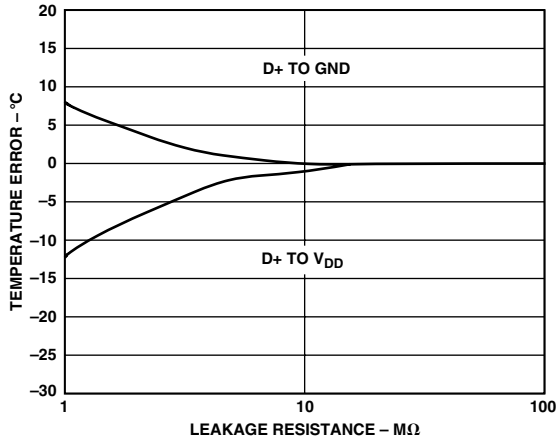

TPC 1. Temperature Error vs. PC Board Track Resistance

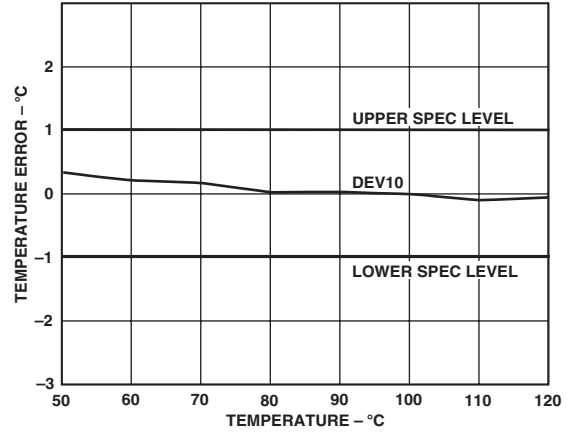

TPC 4. Temperature Error of ADM1021A vs. Pentium III Temperature

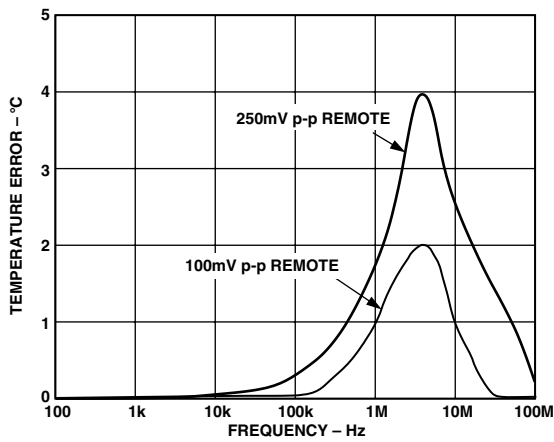

TPC 2. Temperature Error vs. Power Supply Noise Frequency

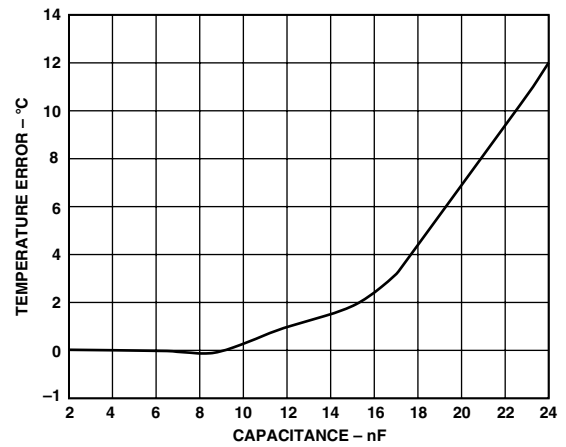

TPC 5. Temperature Error vs. Capacitance Between D+ and D-

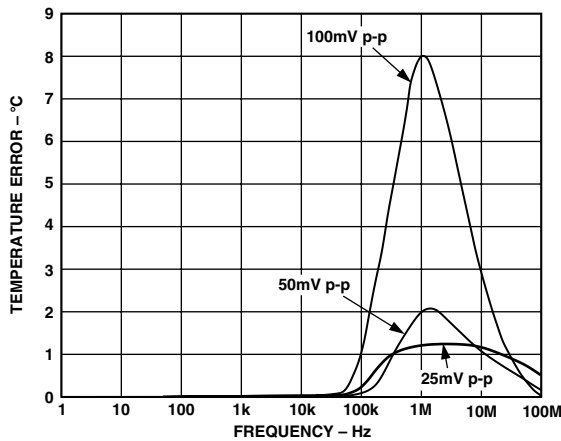

TPC 3. Temperature Error vs. Common-Mode Noise Frequency

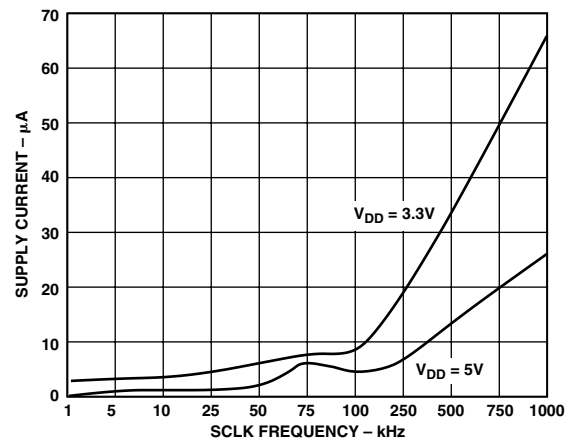

TPC 6. Standby Supply Current vs. Clock Frequency

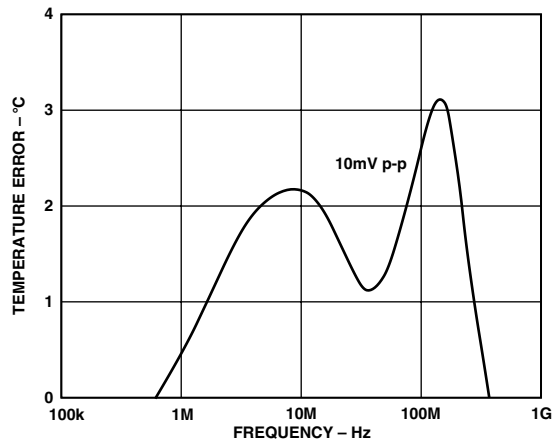

TPC 7. Temperature Error vs. Differential-Mode Noise Frequency

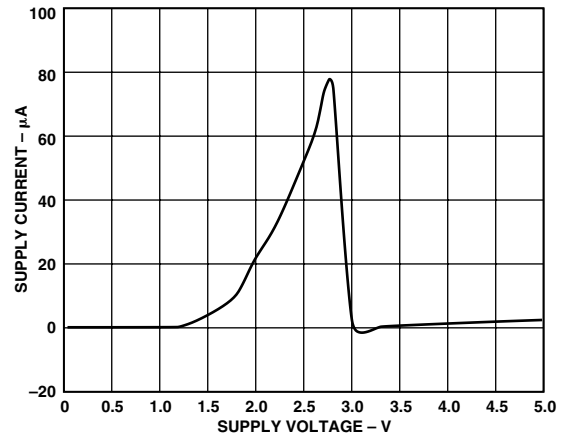

TPC 9. Standby Supply Current vs. Supply Voltage

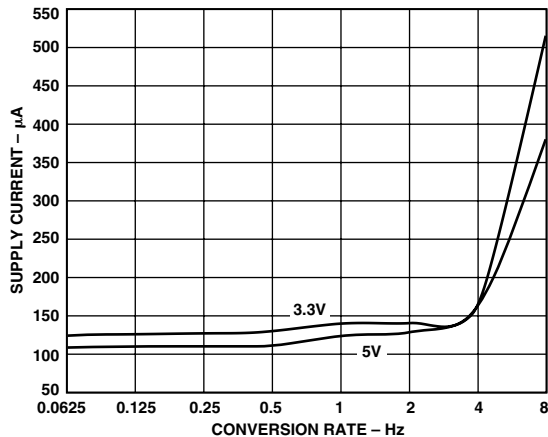

TPC 8. Operating Supply Current vs. Conversion Rate

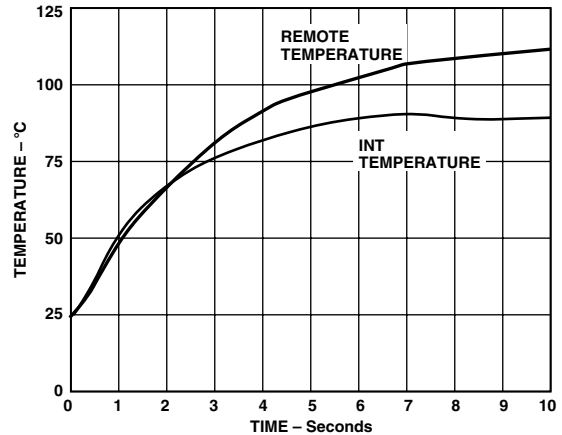

TPC 10. Response to Thermal Shock

## FUNCTIONAL DESCRIPTION

The ADM1021A contains a two-channel A-to-D converter with special input-signal conditioning to enable operation with remote and on-chip diode temperature sensors. When the ADM1021A is operating normally, the A-to-D converter operates in a free-running mode. The analog input multiplexer alternately selects either the on-chip temperature sensor to measure its local temperature, or the remote temperature sensor. These signals are digitized by the ADC and the results stored in the Local and Remote Temperature Value Registers as 8-bit, twos complement words.

The measurement results are compared with local and remote, high and low temperature limits, stored in four on-chip registers. Out-of-limit comparisons generate flags that are stored in the status register, and one or more out-of-limit results will cause the  $\overline{\text{ALERT}}$  output to pull low.

The limit registers can be programmed, and the device controlled and configured, via the serial System Management Bus. The contents of any register can also be read back via the SMBus.

Control and configuration functions consist of:

- Switching the device between normal operation and standby mode.
- Masking or enabling the  $\overline{\text{ALERT}}$  output.
- Selecting the conversion rate.

On initial power-up, the remote and local temperature values default to  $-128^{\circ}\text{C}$ . Since the device normally powers up converting, a measurement of local and remote temperature is made and these values are then stored before a comparison with the stored limits is made. However, if the part is powered up in standby mode ( $\text{STBY}$  pin pulled low), no new values are written to the register before a comparison is made. As a result, both  $\text{RLOW}$  and  $\text{LLOW}$  are tripped in the Status Register, thus generating an  $\overline{\text{ALERT}}$  output. This may be cleared in one of two ways:

1. Change both the local and remote lower limits to  $-128^{\circ}\text{C}$  and read the status register (which in turn clears the  $\overline{\text{ALERT}}$  output).
2. Take the part out of standby and read the status register (which in turn clears the  $\overline{\text{ALERT}}$  output). This will work only if the measured values are within the limit values.

## MEASUREMENT METHOD

A simple method of measuring temperature is to exploit the negative temperature coefficient of a diode, or the base-emitter voltage of a transistor, operated at constant current. Unfortunately, this technique requires calibration to null out the effect of the absolute value of  $V_{\text{BE}}$ , which varies from device to device.

# ADM1021A

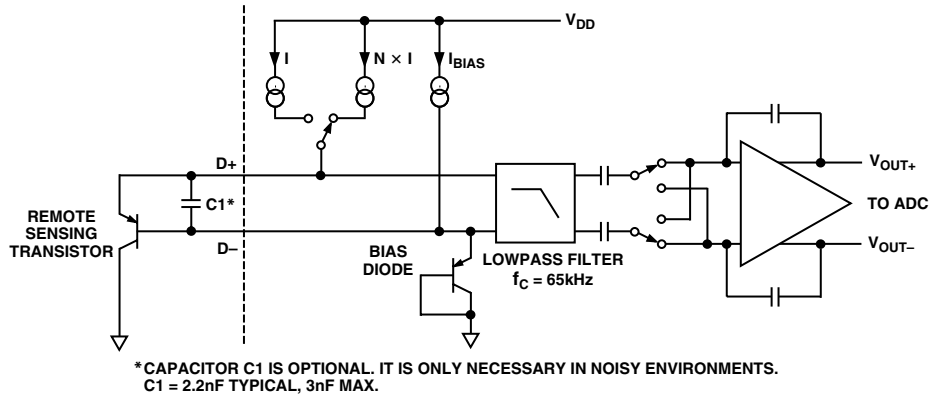

Figure 2. Input Signal Conditioning

The technique used in the ADM1021A is to measure the change in  $V_{BE}$  when the device is operated at two different currents.

This is given by:

$$\Delta V_{BE} = KT/q \times \ln(N)$$

where:

$K$  is Boltzmann's constant,

$q$  is charge on the electron ( $1.6 \times 10^{-19}$  coulombs),

$T$  is absolute temperature in kelvins,

$N$  is ratio of the two currents.

Figure 2 shows the input signal conditioning used to measure the output of an external temperature sensor. This figure shows the external sensor as a substrate transistor, provided for temperature monitoring on some microprocessors, but it could equally well be a discrete transistor. If a discrete transistor is used, the collector will not be grounded and should be linked to the base. To prevent ground noise interfering with the measurement, the more negative terminal of the sensor is not referenced to ground, but is biased above ground by an internal diode at the D- input. If the sensor is operating in a noisy environment, C1 may optionally be added as a noise filter. Its value is typically 2200 pF, but should be no more than 3000 pF. See the section on layout considerations for more information on C1.

To measure  $\Delta V_{BE}$ , the sensor is switched between operating currents of  $I$  and  $N \times I$ . The resulting waveform is passed through a 65 kHz low-pass filter to remove noise, then to a chopper-stabilized amplifier that performs the functions of amplification and rectification of the waveform to produce a dc voltage proportional to  $\Delta V_{BE}$ . This voltage is measured by the ADC to give a temperature output in 8-bit twos complement format. To reduce the effects of noise further, digital filtering is performed by averaging the results of 16 measurement cycles.

Signal conditioning and measurement of the internal temperature sensor is performed in a similar manner.

## DIFFERENCES BETWEEN THE ADM1021 AND THE ADM1021A

Although the ADM1021A is pin-for-pin compatible with the ADM1021, there are some differences between the two devices. Below is a summary of these differences and reasons for the changes.

1. The ADM1021A forces a larger current through the remote temperature sensing diode, typically 205  $\mu\text{A}$  versus 90  $\mu\text{A}$

for the ADM1021. The main reason for this is to improve the noise immunity of the part.

2. As a result of the greater Remote Sensor Source Current the operating current of the ADM1021A is higher than that of the ADM1021, typically 205 mA versus 160 mA.
3. The temperature measurement range of the ADM1021A is 0°C to 127°C, compared with -128°C to +127°C for the ADM1021. As a result, the ADM1021 should be used if negative temperature measurement is required.
4. The power-on reset values of the remote and local temperature values are -128°C in the ADM1021A as compared with 0°C in the ADM1021. As the part is powered up converting (except when the part is in standby mode, i.e., Pin 15 is pulled low) the part will measure the actual values of remote and local temperature and write these to the registers.
5. The four MSBs of the Revision Register may be used to identify the part. The ADM1021 Revision Register reads 0xh and the ADM1021A reads 3xh.
6. The power-on default value of the Address Pointer Register is undefined in the ADM1021A and is equal to 00h in the ADM1021. As a result, a value must be written to the Address Pointer Register before a read is done in the ADM1021A. The ADM1021 is capable of reading back local temperature without writing to the Address Pointer Register as it defaulted to the local temperature measurement register at power-up.
7. Setting the mask bit (Bit 7 Config Reg) on the ADM1021A will mask current and future ALERTs. On the ADM1021 the mask bit will only mask future ALERTs. Any current ALERT will have to be cleared using an ARA.

## TEMPERATURE DATA FORMAT

One LSB of the ADC corresponds to 1°C, so the ADC can theoretically measure from -128°C to +127°C, although the device does not measure temperatures below 0°C so the *actual range is 0°C to 127°C*. The temperature data format is shown in Table I.

The results of the local and remote temperature measurements are stored in the local and remote temperature value registers, and are compared with limits programmed into the local and remote high and low limit registers.

**Table I. Temperature Data Format**

Temperature	Digital Output
0°C	0 000 0000
1°C	0 000 0001
10°C	0 000 1010
25°C	0 001 1001
50°C	0 011 0010
75°C	0 100 1011
100°C	0 110 0100
125°C	0 111 1101
127°C	0 111 1111

## REGISTERS

The ADM1021A contains nine registers that are used to store the results of remote and local temperature measurements, high and low temperature limits, and to configure and control the device. A description of these registers follows, and further details are given in Tables II to IV. It should be noted that the ADM1021A's registers are dual port, and have different addresses for read and write operations. Attempting to write to a read address, or to read from a write address, will produce an invalid result. Register addresses above 0Fh are reserved for future use or used for factory test purposes and should not be written to.

### Address Pointer Register

The Address Pointer Register itself does not have, nor does it require, an address, as it is the register to which the first data byte of every write operation is written automatically. This data byte is an address pointer that sets up one of the other registers for the second byte of the write operation, or for a subsequent read operation.

## Value Registers

The ADM1021A has two registers to store the results of local and remote temperature measurements. These registers are written to by the ADC and can only be read over the SMBus.

### Status Register

Bit 7 of the Status Register indicates when it is high that the ADC is busy converting. Bits 5 to 3 are flags that indicate the results of the limit comparisons.

If the local and/or remote temperature measurement is above the corresponding high temperature limit or below the corresponding low temperature limit, then one or more of these flags will be set. Bit 2 is a flag that is set if the remote temperature sensor is open-circuit. These five flags are NOR'd together, so that if any of them is high, the  $\overline{\text{ALERT}}$  interrupt latch will be set and the  $\overline{\text{ALERT}}$  output will go low. Reading the Status Register will clear the five flag bits, provided the error conditions that caused the flags to be set have gone away. While a limit comparator is tripped due to a value register containing an out-of-limit measurement, or the sensor is open-circuit, the corresponding flag bit cannot be reset. A flag bit can only be reset if the corresponding value register contains an in-limit measurement, or the sensor is good.

**Table II. Status Register Bit Assignments**

Bit	Name	Function
7	BUSY	1 When ADC Converting
6	LHIGH*	1 When Local High Temp Limit Tripped
5	LLOW*	1 When Local Low Temp Limit Tripped
4	RHIGH*	1 When Remote High Temp Limit Tripped
3	RLOW*	1 When Remote Low Temp Limit Tripped
2	OPEN*	1 When Remote Sensor Open-Circuit
1-0		Reserved

\*These flags stay high until the status register is read or they are reset by POR.

**Table III. List of ADM1021A Registers**

READ Address (Hex)	WRITE Address (Hex)	Name	Power-On Default
Not Applicable	Not Applicable	Address Pointer	Undefined
00	Not Applicable	Local Temp. Value	1000 0000 (80h) (-128°C)
01	Not Applicable	Remote Temp. Value	1000 0000 (80h) (-128°C)
02	Not Applicable	Status	Undefined
03	09	Configuration	0000 0000 (00h)
04	0A	Conversion Rate	0000 0010 (02h)
05	0B	Local Temp. High Limit	0111 1111 (7Fh) (+127°C)
06	0C	Local Temp. Low Limit	1100 1001 (C9h) (-55°C)
07	0D	Remote Temp. High Limit	0111 1111 (7Fh) (+127°C)
08	0E	Remote Temp. Low Limit	1100 1001 (C9h) (-55°C)
Not Applicable	0F <sup>1</sup>	One-Shot	
10	Not Applicable	Reserved	Undefined <sup>2</sup>
11	11	Reserved	Undefined <sup>2</sup>
12	12	Reserved	Undefined <sup>2</sup>
13	13	Reserved	Undefined <sup>2</sup>
14	14	Reserved	Undefined <sup>2</sup>
15	16	Reserved	Undefined <sup>2</sup>
17	18	Reserved	Undefined <sup>2</sup>
19	Not Applicable	Reserved	Undefined <sup>2</sup>
20	21	Reserved	Undefined <sup>2</sup>
FE	Not Applicable	Manufacturer Device ID	0100 0001 (41h)
FF	Not Applicable	Die Revision Code	0011 xxxx (3xh)

## NOTES

<sup>1</sup>Writing to address 0F causes the ADM1021A to perform a single measurement. It is not a data register as such and it does not matter what data is written to it.

<sup>2</sup>These registers are reserved for future versions of the device.

# ADM1021A

The  $\overline{\text{ALERT}}$  interrupt latch is not reset by reading the Status Register, but will be reset when the  $\overline{\text{ALERT}}$  output has been serviced by the master reading the device address, provided the error condition has gone away and the Status Register flag bits have been reset.

## Configuration Register

Two bits of the configuration register are used. If Bit 6 is 0, which is the power-on default, the device is in operating mode with the ADC converting. If Bit 6 is set to 1, the device is in standby mode and the ADC does not convert. Standby mode can also be selected by taking the  $\text{STBY}$  pin low. In standby mode the values stored in the Remote and Local Temperature Registers remain at the value they were when the part was placed in standby.

Bit 7 of the configuration register is used to mask the  $\overline{\text{ALERT}}$  output. If Bit 7 is 0, which is the power-on default, the  $\overline{\text{ALERT}}$  output is enabled. If Bit 7 is set to 1, the  $\overline{\text{ALERT}}$  output is disabled.

**Table IV. Configuration Register Bit Assignments**

Bit	Name	Function	Power-On Default
7	MASK1	0 = $\overline{\text{ALERT}}$ Enabled 1 = $\overline{\text{ALERT}}$ Masked	0
6	RUN/STOP	0 = Run 1 = Standby	0
5–0		Reserved	0

## Conversion Rate Register

The lowest three bits of this register are used to program the conversion rate by dividing the ADC clock by 1, 2, 4, 8, 16, 32, 64, or 128, to give conversion times from 125 ms (Code 07h) to 16 seconds (Code 00h). This register can be written to and read back over the SMBus. The higher five bits of this register are unused and must be set to zero. Use of slower conversion times greatly reduces the device power consumption, as shown in Table V.

**Table V. Conversion Rate Register Codes**

Data	Conversion/sec	Average Supply Current $\mu\text{A Typ at } V_{\text{CC}} = 3.3 \text{ V}$
00h	0.0625	150
01h	0.125	150
02h	0.25	150
03h	0.5	150
04h	1	150
05h	2	150
06h	4	160
07h	8	180
08h to FFh	Reserved	

## Limit Registers

The ADM1021A has four limit registers to store local and remote, high and low temperature limits. These registers can be written to and read back over the SMBus. The high limit registers perform a > comparison while the low limit registers perform a < comparison. For example, if the high limit register is programmed as a limit of 80°C, measuring 81°C will result in an alarm condition. Even though the temperature measurement range is from 0° to 127°C, it is possible to program the limit register with negative values. This is for backwards-compatibility with the ADM1021.

## One-Shot Register

The one-shot register is used to initiate a single conversion and comparison cycle when the ADM1021A is in standby mode, after which the device returns to standby. This is not a data register as such and it is the write operation that causes the one-shot conversion. The data written to this address is irrelevant and is not stored.

## SERIAL BUS INTERFACE

Control of the ADM1021A is carried out via the serial bus. The ADM1021A is connected to this bus as a slave device, under the control of a master device. Note that the SMBus and SCL pins are three-stated when the ADM1021A is powered down and will not pull down the SMBus.

## ADDRESS PINS

In general, every SMBus device has a 7-bit device address (except for some devices that have extended, 10-bit addresses). When the master device sends a device address over the bus, the slave device with that address will respond. The ADM1021A has two address pins, ADD0 and ADD1, to allow selection of the device address, so that several ADM1021As can be used on the same bus, and/or to avoid conflict with other devices. Although only two address pins are provided, these are three-state, and can be grounded, left unconnected, or tied to  $V_{\text{DD}}$ , so that a total of nine different addresses are possible, as shown in Table VI.

It should be noted that the state of the address pins is only sampled at power-up, so changing them after power-up will have no effect.

**Table VI. Device Addresses**

ADD0	ADD1	Device Address
0	0	0011 000
0	NC	0011 001
0	1	0011 010
NC	0	0101 001
NC	NC	0101 010
NC	1	0101 011
1	0	1001 100
1	NC	1001 101
1	1	1001 110

ADD0, ADD1 sampled at power-up only.

The serial bus protocol operates as follows:

1. The master initiates data transfer by establishing a START condition, defined as a high-to-low transition on the serial data line SDATA, while the serial clock line SCLK remains high. This indicates that an address/data stream will follow. All slave peripherals connected to the serial bus respond to the START condition and shift in the next eight bits, consisting of a 7-bit address (MSB first) plus an  $\text{R}/\overline{\text{W}}$  bit, which determines the direction of the data transfer, i.e., whether data will be written to or read from the slave device.

The peripheral whose address corresponds to the transmitted address responds by pulling the data line low during the low period before the ninth clock pulse, known as the Acknowledge Bit. All other devices on the bus now remain idle while the selected device waits for data to be read from or written to it. If the  $\text{R}/\overline{\text{W}}$  bit is a 0, the master will write to the slave device. If the  $\text{R}/\overline{\text{W}}$  bit is a 1, the master will read from the slave device.



2. Data is sent over the serial bus in sequences of nine clock pulses, eight bits of data followed by an Acknowledge Bit from the slave device. Transitions on the data line must occur during the low period of the clock signal and remain stable during the high period, as a low-to-high transition when the clock is high may be interpreted as a stop signal. The number of data bytes that can be transmitted over the serial bus in a single read or write operation is limited only by what the master and slave devices can handle.
3. When all data bytes have been read or written, stop conditions are established. In write mode, the master will pull the data line high during the 10th clock pulse to assert a stop condition. In read mode, the master device will override the acknowledge bit by pulling the data line high during the low period before the ninth clock pulse. This is known as No Acknowledge. The master will then take the data line low during the low period before the 10th clock pulse, then high during the 10th clock pulse to assert a stop condition.

Any number of bytes of data may be transferred over the serial bus in one operation, but it is not possible to mix read and write in one operation, because the type of operation is determined at the beginning and cannot subsequently be changed without starting a new operation.

In the case of the ADM1021A, write operations contain either one or two bytes, while read operations contain one byte.

To write data to one of the device data registers or read data from it, the Address Pointer Register must be set so that the correct data register is addressed, data can then be written into that register or read from it. The first byte of a write operation always contains a valid address that is stored in the Address Pointer Register. If data is to be written to the device, the write operation contains a second data byte that is written to the register selected by the address pointer register.

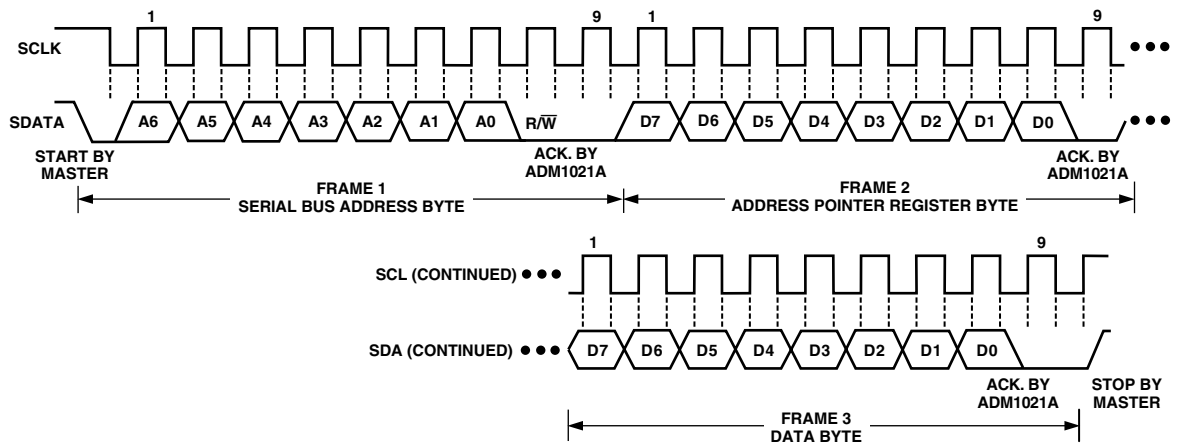

Figure 3. Writing a Register Address to the Address Pointer Register, then Writing Data to the Selected Register

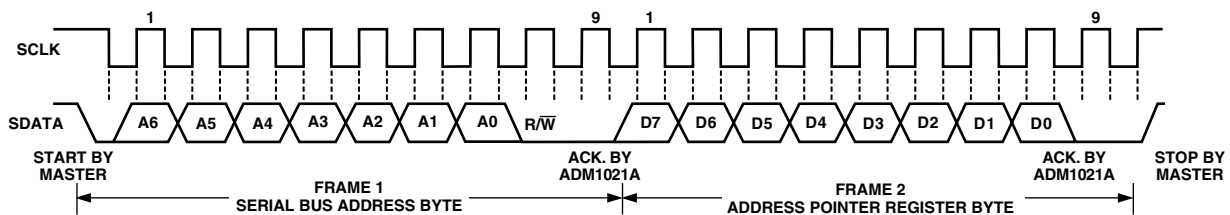

Figure 4. Writing to the Address Pointer Register Only

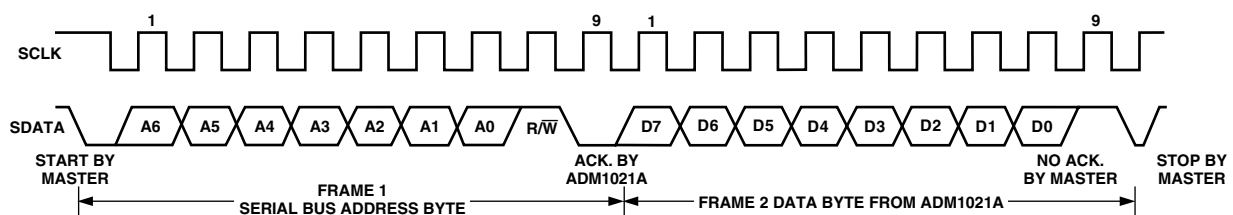

Figure 5. Reading Data from a Previously Selected Register

# ADM1021A

This is illustrated in Figure 3. The device address is sent over the bus followed by  $R/\overline{W}$  set to 0. This is followed by two data bytes. The first data byte is the address of the internal data register to be written to, which is stored in the Address Pointer Register. The second data byte is the data to be written to the internal data register.

When reading data from a register there are two possibilities:

1. If the ADM1021A's Address Pointer Register value is unknown or not the desired value, it is first necessary to set it to the correct value before data can be read from the desired data register. This is done by performing a write to the ADM1021A as before, but only the data byte containing the register read address is sent, as data is not to be written to the register. This is shown in Figure 4.

A read operation is then performed consisting of the serial bus address,  $R/\overline{W}$  bit set to 1, followed by the data byte read from the data register. This is shown in Figure 5.

2. If the Address Pointer Register is known to be already at the desired address, data can be read from the corresponding data register without first writing to the Address Pointer Register, so Figure 4 can be omitted.

## NOTES

1. Although it is possible to read a data byte from a data register without first writing to the Address Pointer Register, if the Address Pointer Register is already at the correct value, it is not possible to write data to a register without writing to the Address Pointer Register, because the first data byte of a write is always written to the Address Pointer Register.
2. Remember that the ADM1021A registers have different addresses for read and write operations. The write address of a register must be written to the Address Pointer if data is to be written to that register, but it is not possible to read data from that address. The read address of a register must be written to the Address Pointer before data can be read from that register.

## ALERT OUTPUT

The  $\overline{ALERT}$  output goes low whenever an out-of-limit measurement is detected, or if the remote temperature sensor is open-circuit. It is an open-drain and requires a 10 k $\Omega$  pull-up to  $V_{DD}$ . Several  $\overline{ALERT}$  outputs can be wire-ANDed together, so that the common line will go low if one or more of the  $\overline{ALERT}$  outputs goes low.

The  $\overline{ALERT}$  output can be used as an interrupt signal to a processor, or it may be used as an  $\overline{SMBALERT}$ . Slave devices on the SMBus can normally not signal to the master that they want to talk, but the  $\overline{SMBALERT}$  function allows them to do so.

One or more  $\overline{ALERT}$  outputs are connected to a common  $\overline{SMBALERT}$  line connected to the master. When the  $\overline{SMBALERT}$  line is pulled low by one of the devices, the following procedure occurs as illustrated in Figure 6.

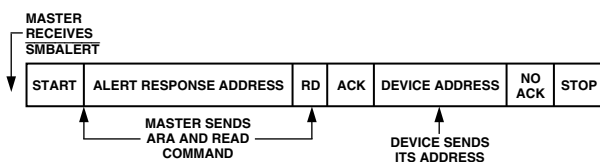

Figure 6. Use of  $\overline{SMBALERT}$

1.  $\overline{SMBALERT}$  is pulled low.
2. Master initiates a read operation and sends the Alert Response Address (ARA = 0001 100). This is a general call address that must not be used as a specific device address.
3. The device whose  $\overline{ALERT}$  output is low responds to the Alert Response Address and the master reads its device address. The address of the device is now known and it can be interrogated in the usual way.
4. If more than one device's  $\overline{ALERT}$  output is low, the one with the lowest device address will have priority, in accordance with normal SMBus arbitration.
5. Once the ADM1021A has responded to the Alert Response Address, it will reset its  $\overline{ALERT}$  output, provided that the error condition that caused the  $\overline{ALERT}$  no longer exists. If the  $\overline{SMBALERT}$  line remains low, the master will send the ARA again, and so on until all devices whose  $\overline{ALERT}$  outputs were low have responded.

## LOW POWER STANDBY MODES

The ADM1021A can be put into a low power standby mode using hardware or software, that is, by taking the  $\overline{STBY}$  input low, or by setting Bit 6 of the Configuration Register. When  $\overline{STBY}$  is high, or Bit 6 is low, the ADM1021A operates normally. When  $\overline{STBY}$  is pulled low or Bit 6 is high, the ADC is inhibited, so any conversion in progress is terminated without writing the result to the corresponding value register.

The SMBus is still enabled. Power consumption in the standby mode is reduced to less than 10  $\mu$ A if there is no SMBus activity, or 100  $\mu$ A if there are clock and data signals on the bus.

These two modes are similar but not identical. When  $\overline{STBY}$  is low, conversions are completely inhibited. When Bit 6 is set but  $\overline{STBY}$  is high, a one-shot conversion of both channels can be initiated by writing XXh to the One-Shot Register (address 0Fh).

## SENSOR FAULT DETECTION

The ADM1021A has a fault detector at the D+ input that detects if the external sensor diode is open-circuit. This is a simple voltage comparator that trips if the voltage at D+ exceeds  $V_{CC} - 1$  V (typical). The output of this comparator is checked when a conversion is initiated, and sets Bit 2 of the Status Register if a fault is detected.

If the remote sensor voltage falls below the normal measuring range, for example due to the diode being short-circuited, the ADC will output  $-128^{\circ}\text{C}$  (1000 0000). Since the normal operating temperature range of the device only extends down to  $0^{\circ}\text{C}$ , this output code will never be seen in normal operation, so it can be interpreted as a fault condition.

In this respect, the ADM1021A differs from and improves upon competitive devices that output zero if the external sensor goes short-circuit. These devices can misinterpret a genuine  $0^{\circ}\text{C}$  measurement as a fault condition.

If the external diode channel is not being used and is shorted out, the resulting  $\overline{ALERT}$  may be cleared by writing 80h ( $-128^{\circ}\text{C}$ ) to the low limit register.

## APPLICATIONS INFORMATION

### FACTORS AFFECTING ACCURACY

#### Remote Sensing Diode

The ADM1021A is designed to work with substrate transistors built into processors, or with discrete transistors. Substrate transistors will generally be PNP types with the collector connected to the substrate. Discrete types can be either PNP or NPN, connected as a diode (base shorted to collector). If an NPN transistor is used, the collector and base are connected to D+ and the emitter to D-. If a PNP transistor is used, the collector and base are connected to D- and the emitter to D+.

The user has no choice in the case of substrate transistors, but if a discrete transistor is used, the best accuracy will be obtained by choosing devices according to the following criteria:

1. Base-emitter voltage greater than 0.25 V at 6  $\mu$ A, at the highest operating temperature.
2. Base-emitter voltage less than 0.95 V at 100  $\mu$ A, at the lowest operating temperature.
3. Base resistance less than 100  $\Omega$ .
4. Small variation in  $h_{FE}$  (say 50 to 150), which indicates tight control of  $V_{BE}$  characteristics.

Transistors such as 2N3904, 2N3906, or equivalents in SOT-23 package are suitable devices to use.

#### Thermal Inertia and Self-Heating

Accuracy depends on the temperature of the remote-sensing diode and/or the internal temperature sensor being at the same temperature as that being measured, and a number of factors can affect this. Ideally, the sensor should be in good thermal contact with the part of the system being measured, for example the processor. If it is not, the thermal inertia caused by the mass of the sensor will cause a lag in the response of the sensor to a temperature change. In the case of the remote sensor this should not be a problem, as it will be either a substrate transistor in the processor or a small package device such as SOT-23 placed in close proximity to it.

The on-chip sensor, however, will often be remote from the processor and will only be monitoring the general ambient temperature around the package. The thermal time constant of the QSOP-16 package is about 10 seconds.

In practice, the package will have electrical, and hence thermal, connection to the printed circuit board, so the temperature rise due to self-heating will be negligible.

## LAYOUT CONSIDERATIONS

Digital boards can be electrically noisy environments, and because the ADM1021A is measuring very small voltages from the remote sensor, care must be taken to minimize noise induced at the sensor inputs. The following precautions should be taken:

1. Place the ADM1021A as close as possible to the remote sensing diode. Provided that the worst noise sources such as clock generators, data/address buses, and CRTs are avoided, this distance can be four to eight inches.
2. Route the D+ and D- tracks close together, in parallel, with grounded guard tracks on each side. Provide a ground plane under the tracks if possible.
3. Use wide tracks to minimize inductance and reduce noise pickup. 10 mil track minimum width and spacing is recommended.
4. Try to minimize the number of copper/solder joints, which can cause thermocouple effects. Where copper/solder joints are used, make sure that they are in both the D+ and D- paths and at the same temperature.

Thermocouple effects should not be a major problem as 1°C corresponds to about 240  $\mu$ V, and thermocouple voltages are about 3  $\mu$ V/°C of temperature difference. Unless there are two thermocouples with a big temperature differential between them, thermocouple voltages should be much less than 240  $\mu$ V.

5. Place a 0.1  $\mu$ F bypass capacitor close to the  $V_{DD}$  pin, and 2200 pF input filter capacitors across D+, D- close to the ADM1021A.



Figure 7. Arrangement of Signal Tracks

6. If the distance to the remote sensor is more than eight inches, the use of twisted pair cable is recommended. This will work up to about 6 to 12 feet.

# ADM1021A

7. For really long distances (up to 100 feet), use shielded twisted pair such as Belden #8451 microphone cable. Connect the twisted pair to D+ and D- and the shield to GND close to the ADM1021A. Leave the remote end of the shield unconnected to avoid ground loops.

Because the measurement technique uses switched current sources, excessive cable and/or filter capacitance can affect the measurement. When using long cables, the filter capacitor may be reduced or removed.

Cable resistance can also introduce errors. 1 Ω series resistance introduces about 1°C error.

## APPLICATION CIRCUITS

Figure 8 shows a typical application circuit for the ADM1021A, using a discrete sensor transistor connected via a shielded, twisted pair cable. The pull-ups on SCLK, SDATA, and ALERT are required only if they are not already provided elsewhere in the system.

The SCLK and SDATA pins of the ADM1021A can be interfaced directly to the SMBus of an I/O chip. Figure 9 shows how the ADM1021A might be integrated into a system using this type of I/O controller.

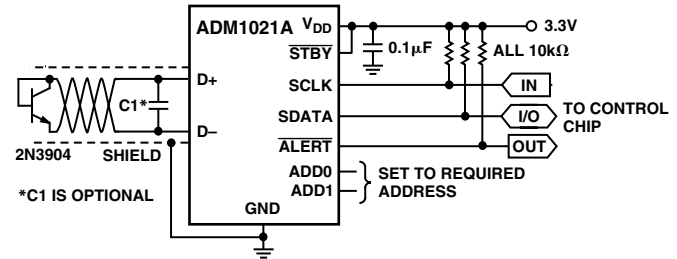

Figure 8. Typical Application Circuit

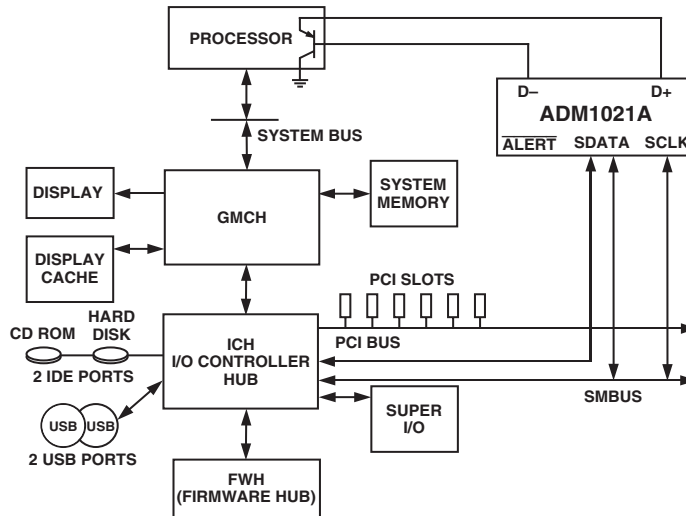
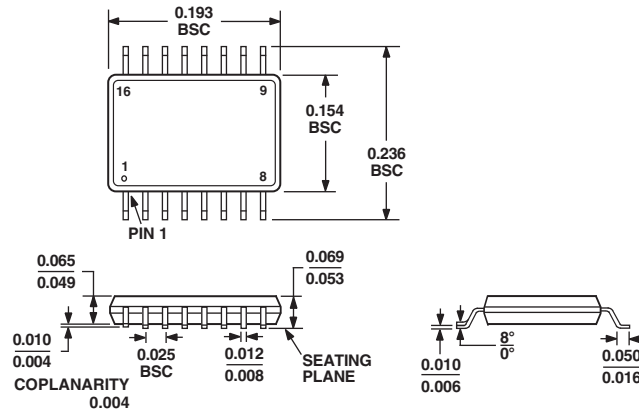

Figure 9. Typical System Using ADM1021A

OUTLINE DIMENSIONS

16-Lead Shrink Small Outline Package [QSOP]  
(RQ-16)

Dimensions shown in inches



# ADM1021A

## Revision History

Location	Page
<b>3/04—Data Sheet changed from REV. C to REV. D.</b>	
Changes to FEATURES .....	1
Updated Ordering Guide .....	3
Change to Figure 9 .....	12
<b>4/03—Data Sheet changed from REV. B to REV. C.</b>	
Added ESD Caution .....	3
Updated OUTLINE DIMENSIONS .....	12
<b>3/02—Data Sheet changed from REV. A to REV. B.</b>	
Figures and TPCs renumbered .....	UNIVERSAL
Text Change to Figure 9 .....	5
Change to SERIAL BUS INTERFACE section .....	8



