

ADM1810–ADM1813/ADM1815–ADM1818

FEATURES

Reliable Low Cost Voltage Monitor with Reset Output Suitable for Monitoring 2.5 V, 3 V, 3.3 V, and 5 V Power Supply Voltages

Reset Threshold Levels: 4.62 V, 4.35 V, 3.06 V, 2.88 V, 2.55 V, 2.31 V, and 2.18 V (Typ)

Active High and Low Push-Pull Output Choices (ADM1810, ADM1812, ADM1815, and ADM1817)

Open-Drain Output Choices (ADM1811, ADM1813, ADM1816, and ADM1818)

Can Be Used with a Manual Push-Button to Generate a Reset (ADM1813, ADM1818)

Initialize Microprocessor Systems with Added Safety Available in a 3-Lead SOT-23 Package

APPLICATIONS

Microprocessor Systems

Computers

Controllers

Intelligent Instruments

Automotive Systems

GENERAL DESCRIPTION

The ADM181x range of voltage monitoring circuits can be used in any application where an electronic system needs to be reset when a voltage increases above or below a predetermined value.

Because of the reset delay time incorporated into the ADM181x series, these devices can provide a safe startup for electronic systems. Before a system initializes, the power supply must stabilize. Using the ADM181x series ensures that there are typically 150 ms for the power supply to stabilize before the system is reset and safe system initialization begins.

The ADM181x series of microprocessor reset circuits are available in low cost, space-saving SOT-23 packages.

FUNCTIONAL BLOCK DIAGRAMS

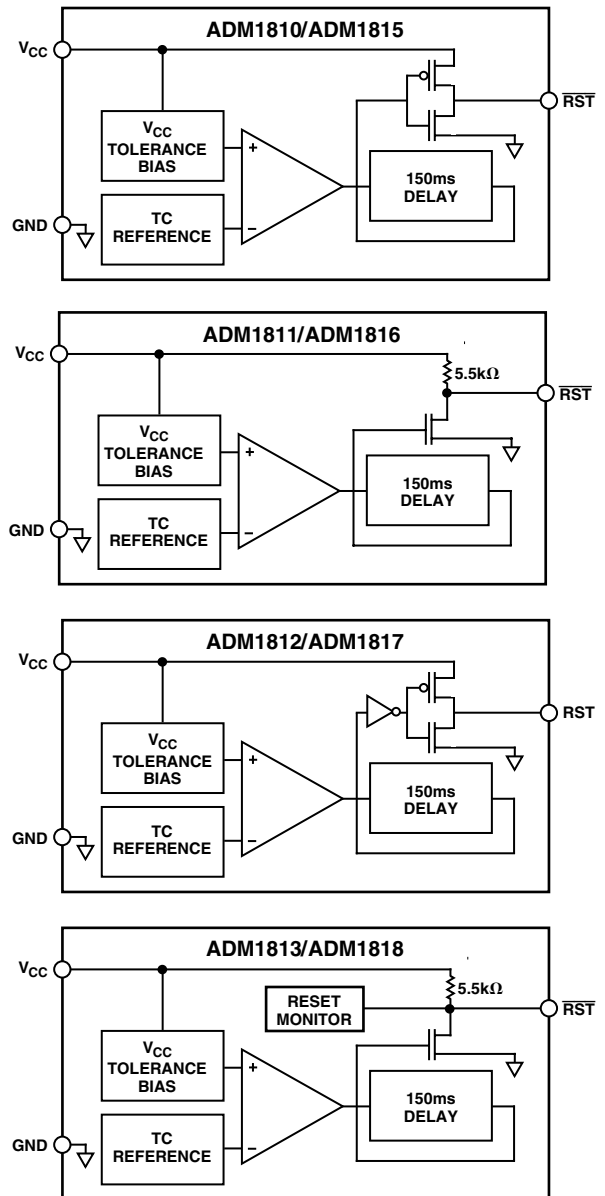

REV. B

Information furnished by Analog Devices is believed to be accurate and reliable. However, no responsibility is assumed by Analog Devices for its use, nor for any infringements of patents or other rights of third parties that may result from its use. No license is granted by implication or otherwise under any patent or patent rights of Analog Devices. Trademarks and registered trademarks are the property of their respective companies.

ADM1810–ADM1813/ADM1815–ADM1818–SPECIFICATIONS

(V_{CC} = Full Operating Range, T_A = -40°C to $+105^{\circ}\text{C}$, unless otherwise noted.)

Parameter	Min	Typ	Max	Unit	Conditions/Note
SUPPLY					
Voltage	1		5.5	V	$T_A = 0^{\circ}\text{C}$ to 105°C
	1.2		5.5	V	$T_A = -40^{\circ}\text{C}$ to $+105^{\circ}\text{C}$
Current		9	16	μA	$V_{CC} = 5.5\text{ V}$, $V_{CC} > V_{TH}$, No Load
		4	10	μA	$V_{CC} = 3.6\text{ V}$, $V_{CC} > V_{TH}$, No Load
OUTPUT CURRENT					
$\overline{\text{RST}}$ Output Source Current		350		μA	$V_{CC} \geq V_{TH}$ (Max), Reset Not Asserted (ADM1810/ADM1815)
RST Output Source Current		350		μA	$V_{CC} \leq V_{TH}$ (Min), Reset Asserted (ADM1812/ADM1817)
$\overline{\text{RST}}$ Output Sink Current	8			mA	$V_{CC} \geq 2.7\text{ V}$, Reset Asserted, $V_{OUT} = 0.4\text{ V}$, (ADM1810/ADM1811/ADM1813/ADM1815/ADM1816/ADM1818)
RST Output Sink Current	8			mA	$V_{CC} \geq 2.7\text{ V}$, Reset Not Asserted, $V_{OUT} = 0.4\text{ V}$ (ADM1812/ADM1817)
OUTPUT VOLTAGE					
	$V_{CC} - 0.5$	$V_{CC} - 0.1$		V	(ADM1810/ADM1812/ADM1815/ADM1817) @ $0\ \mu\text{A}$ to $500\ \mu\text{A}$
V_{CC} TRIP POINT					
ADM1810-5, ADM1811-5, ADM1812-5, ADM1813-5	4.50	4.62	4.75	V	
ADM1810-10, ADM1811-10, ADM1812-10, ADM1813-10	4.25	4.35	4.49	V	
ADM1815-5, ADM1816-5, ADM1817-5	2.98	3.06	3.15	V	
ADM1815-10, ADM1816-10	2.80	2.88	2.97	V	
ADM1817-10, ADM1818-10					
ADM1815-20, ADM1816-20	2.47	2.55	2.64	V	
ADM1817-20, ADM1818-20					
ADM1815-R23, ADM1816-R23	2.25	2.31	2.37	V	
ADM1817-R23					
ADM1815-R22, ADM1816-R22	2.12	2.18	2.25	V	
ADM1817-R22					
INTERNAL PULL-UP RESISTOR					
ADM1811/ADM1816	3.5	5.5	7.5	$\text{k}\Omega$	
ADM1813/ADM1818	3.1	5.5	7.5	$\text{k}\Omega$	
OUTPUT CAPACTANCE					
			10	pF	
RESET ACTIVE TIME					
	100	150	250	ms	
V_{CC} DETECT TO RESET					
Falling		5	10	μs	(ADM1810/ADM1811/ADM1812/ADM1813)
		7	15	μs	(ADM1815/ADM1816/ADM1817/ADM1818)
Rising	100	150	250	ms	$t_R = 5\ \mu\text{s}$
PUSH-BUTTON DETECT TO $\overline{\text{RST}}$					
	1			μs	(ADM1813/ADM1818)
PUSH-BUTTON RESET					
	100	150	250	ms	(ADM1813/ADM1818)

Specifications subject to change without notice.

ADM1810–ADM1813/ADM1815–ADM1818

ABSOLUTE MAXIMUM RATINGS*

(T_A = 25°C, unless otherwise noted.)

V _{CC}	-0.3 V to +6.0 V
Input Current	20 mA
Operating Temperature Range	-40°C to +105°C
θ _{JA} Thermal Impedance, SOT-23	270°C/W
Lead Temperature (Soldering, 10 sec)	300°C
Vapor Phase (60 sec)	215°C
Infrared (15 sec)	220°C
Storage Temperature Range	-65°C to +150°C

*Stresses above those listed under Absolute Maximum Ratings may cause permanent damage to the device. This is a stress rating only; functional operation of the device at these or any other conditions above those listed in the operational sections of this specification is not implied. Exposure to absolute maximum ratings for extended periods of time may affect device reliability.

PIN CONFIGURATION

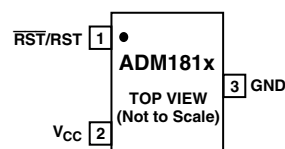

PIN FUNCTION DESCRIPTIONS

Pin	Mnemonic	Function
1	$\overline{\text{RST}}/\text{RST}$	Reset Output. $\overline{\text{RST}}/\text{RST}$ remains active while V _{CC} is below the reset threshold and remains active for 150 ms (typ) after V _{CC} rises above the reset threshold.
2	V _{CC}	Supply voltage being monitored.
3	GND	0 V. Ground reference for all signals.

ORDERING GUIDE

Model*	Trip Point	Package Option	Brand Info.	Model*	Trip Point	Package Option	Brand Info.
ADM1810-5ART-REEL	4.62 V	RT-3 (SOT-23)	MZV	ADM1815-R22ART-RL7	2.18 V	RT-3 (SOT-23)	M5B
ADM1810-5ART-RL7	4.62 V	RT-3 (SOT-23)	MZV	ADM1816-5ART-REEL	3.06 V	RT-3 (SOT-23)	M6K
ADM1810-10ART-REEL	4.35 V	RT-3 (SOT-23)	MZT	ADM1816-5ART-RL7	3.06 V	RT-3 (SOT-23)	M6K
ADM1810-10ART-RL7	4.35 V	RT-3 (SOT-23)	MZT	ADM1816-10ART-REEL	2.88 V	RT-3 (SOT-23)	M6E
ADM1811-5ART-REEL	4.62 V	RT-3 (SOT-23)	M1V	ADM1816-10ART-RL7	2.88 V	RT-3 (SOT-23)	M6E
ADM1811-5ART-RL7	4.62 V	RT-3 (SOT-23)	M1V	ADM1816-20ART-REEL	2.55 V	RT-3 (SOT-23)	M6A
ADM1811-10ART-REEL	4.35 V	RT-3 (SOT-23)	M1T	ADM1816-20ART-RL7	2.55 V	RT-3 (SOT-23)	M6A
ADM1811-10ART-RL7	4.35 V	RT-3 (SOT-23)	M1T	ADM1816-R23ART-REEL	2.31 V	RT-3 (SOT-23)	M6C
ADM1812-5ART-REEL	4.62 V	RT-3 (SOT-23)	MTV	ADM1816-R23ART-RL7	2.31 V	RT-3 (SOT-23)	M6C
ADM1812-5ART-RL7	4.62 V	RT-3 (SOT-23)	MTV	ADM1816-R22ART-REEL	2.18 V	RT-3 (SOT-23)	M6B
ADM1812-10ART-REEL	4.35 V	RT-3 (SOT-23)	MTT	ADM1816-R22ART-RL7	2.18 V	RT-3 (SOT-23)	M6B
ADM1812-10ART-RL7	4.35 V	RT-3 (SOT-23)	MTT	ADM1817-5ART-REEL	3.06 V	RT-3 (SOT-23)	M7K
ADM1813-5ART-REEL	4.62 V	RT-3 (SOT-23)	M3V	ADM1817-5ART-RL7	3.06 V	RT-3 (SOT-23)	M7K
ADM1813-5ART-RL7	4.62 V	RT-3 (SOT-23)	M3V	ADM1817-10ART-REEL	2.88 V	RT-3 (SOT-23)	M7E
ADM1813-10ART-REEL	4.35 V	RT-3 (SOT-23)	M3T	ADM1817-10ART-RL7	2.88 V	RT-3 (SOT-23)	M7E
ADM1813-10ART-RL7	4.35 V	RT-3 (SOT-23)	M3T	ADM1817-20ART-REEL	2.55 V	RT-3 (SOT-23)	M7A
ADM1815-5ART-REEL	3.06 V	RT-3 (SOT-23)	M5K	ADM1817-20ART-RL7	2.55 V	RT-3 (SOT-23)	M7A
ADM1815-5ART-RL7	3.06 V	RT-3 (SOT-23)	M5K	ADM1817-R23ART-REEL	2.31 V	RT-3 (SOT-23)	M7C
ADM1815-10ART-REEL	2.88 V	RT-3 (SOT-23)	M5E	ADM1817-R23ART-RL7	2.31 V	RT-3 (SOT-23)	M7C
ADM1815-10ART-RL7	2.88 V	RT-3 (SOT-23)	M5E	ADM1817-R22ART-REEL	2.18 V	RT-3 (SOT-23)	M7B
ADM1815-20ART-REEL	2.55 V	RT-3 (SOT-23)	M5A	ADM1817-R22ART-RL7	2.18 V	RT-3 (SOT-23)	M7B
ADM1815-20ART-RL7	2.55 V	RT-3 (SOT-23)	M5A	ADM1818-10ART-REEL	2.88 V	RT-3 (SOT-23)	M8E
ADM1815-R23ART-REEL	2.31 V	RT-3 (SOT-23)	M5C	ADM1818-10ART-RL7	2.88 V	RT-3 (SOT-23)	M8E
ADM1815-R23ART-RL7	2.31 V	RT-3 (SOT-23)	M5C	ADM1818-20ART-REEL	2.55 V	RT-3 (SOT-23)	M8A
ADM1815-R22ART-REEL	2.18 V	RT-3 (SOT-23)	M5B	ADM1818-20ART-RL7	2.55 V	RT-3 (SOT-23)	M8A

*Only available in reels.

CAUTION

ESD (electrostatic discharge) sensitive device. Electrostatic charges as high as 4000 V readily accumulate on the human body and test equipment and can discharge without detection. Although the ADM1810–ADM1813/ADM1815–ADM1818 features proprietary ESD protection circuitry, permanent damage may occur on devices subjected to high energy electrostatic discharges. Therefore, proper ESD precautions are recommended to avoid performance degradation or loss of functionality.



ADM1810–ADM1813/ADM1815–ADM1818–Typical Performance Characteristics

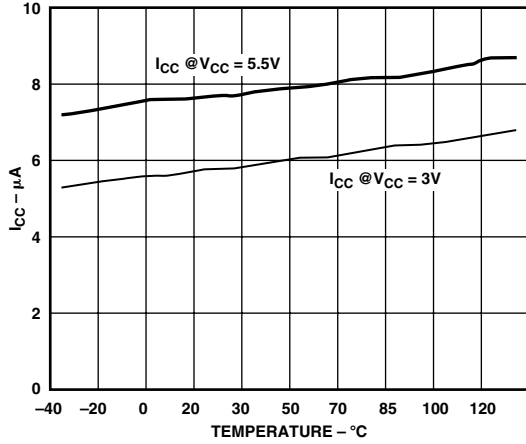

TPC 1. Supply Current vs. Temperature

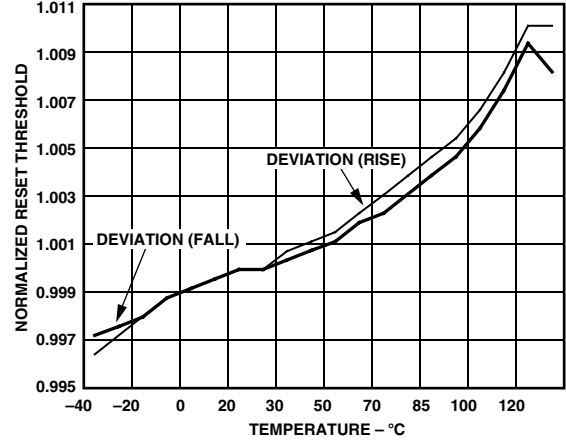

TPC 4. Normalized Reset Threshold vs. Temperature

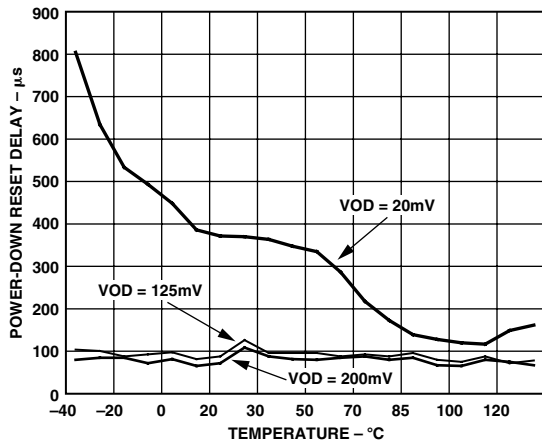

TPC 2. Power-Down Reset Delay vs. Temperature

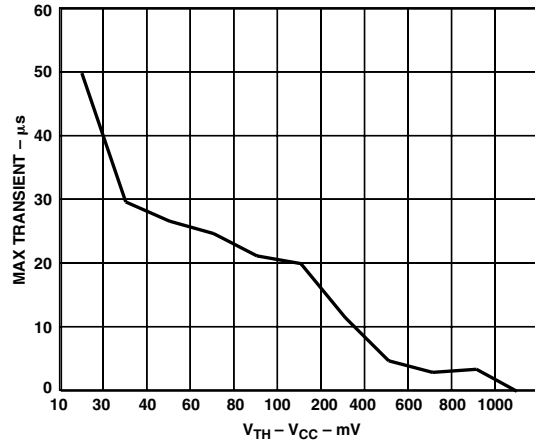

TPC 5. Maximum Transient Duration without Causing a Reset Pulse vs. Reset Comparator Overdrive

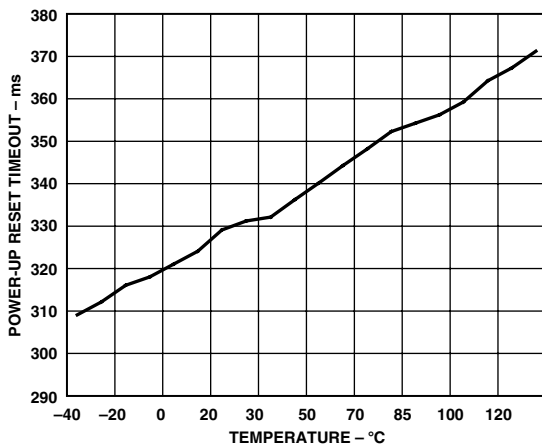

TPC 3. Power-Up Reset Timeout vs. Temperature

ADM1810–ADM1813/ADM1815–ADM1818

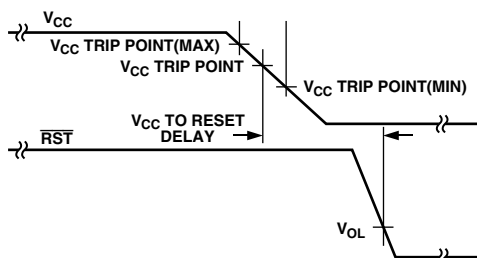

Figure 1. Power-Down Timing Diagram

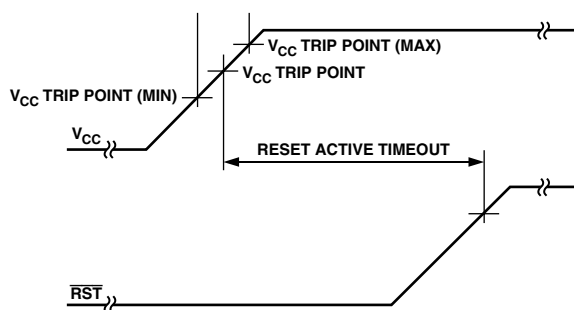

Figure 2. Power-Up Timing Diagram

ADM1813 AND ADM1818

The ADM1813 and ADM1818 are low cost voltage monitoring devices featuring an open-drain output and optional push-button reset function.

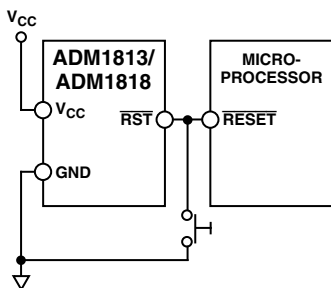

Figure 3. ADM1813/ADM1818 Typical Application

An optional push-button reset switch can be connected between $\overline{\text{RST}}$ and ground. Pressing this switch will pull the reset output low. If the push-button reset button pulls the $\overline{\text{RST}}$ output low for a period greater than $1\ \mu\text{s}$, then, when the reset button releases the $\overline{\text{RST}}$ line to float high, the $\overline{\text{RST}}$ line will stay low for a further 150 ms typical.

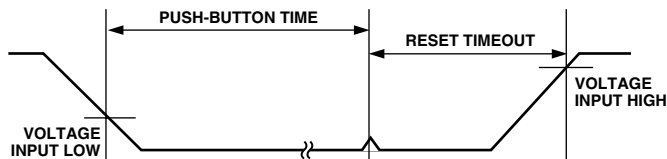

Figure 4. Push-Button Reset Timing Diagram

The ADM1818 range has 2.88 V and 2.55 V (typ) trip point options that allow the user to monitor 3.3 V and 3 V supplies. For 5 V monitoring requirements, the ADM1813 range has 4.62 V and 4.35 V (typ) trip point options.

ADM1810, ADM1812, ADM1815, AND ADM1817

The ADM1812 is a 5 V supply monitor with an active high push-pull output and trip point options of 4.62 V and 4.35 V (typ). The ADM1810 is similar to the ADM1812, except that the ADM1810 has an active low push-pull output stage.

The ADM1817 is suitable for monitoring 3.3 V, 3 V, and 2.5 V supplies, with an active high push-pull output and trip-point options of 3.06 V, 2.88 V, 2.55 V, 2.31 V, and 2.18 V (typ). The ADM1815 is similar to the ADM1817, except that the ADM1815 has an active low push-pull output stage.

The ADM1810/ADM1812/ADM1815/ADM1817 can be connected directly to most microprocessor reset inputs without the need for external components.

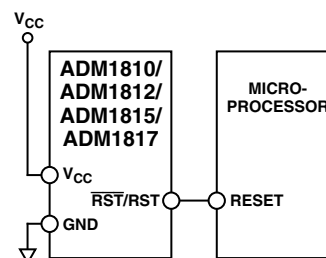

Figure 5. ADM1810/ADM1812/ADM1815/ADM1817 Typical Application

ADM1811 AND ADM1816

The ADM1811 is a 5 V supply monitor with an active low open-drain output and trip point options of 4.62 V and 4.35 V (typ). The ADM1816 also has an active low open-drain output but is suitable for monitoring lower voltage supplies of 3.3 V, 3 V, and 2.5 V.

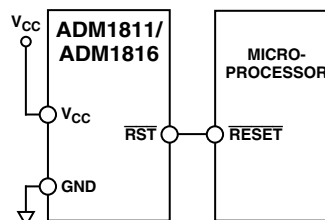

Figure 6. ADM1811/ADM1816 Typical Application

ADM1810–ADM1813/ADM1815–ADM1818

OUTLINE DIMENSIONS

3-Lead Small Outline Transistor Package [SOT-23] (RT-3)

Dimensions shown in millimeters

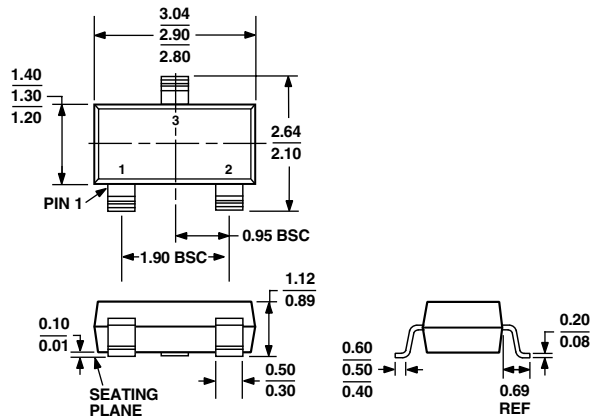

COMPLIANT TO JEDEC STANDARDS TO-236AB

Revision History

Location	Page
2/03 Data Sheet changed from REV. A to REV. B.	
Edits to FEATURES	1
Deleted Table I	1
Edits to SPECIFICATIONS	2
Edits to ABSOLUTE MAXIMUM RATINGS	3
Edits to ORDERING GUIDE	3
Added Typical Performance Characteristics	4
Edits to ADM1813 AND ADM1818 section	5
Edits to ADM1810, ADM1812, ADM1815, AND ADM1817 section	5
Edits to ADM1811 AND ADM1816 section	5
Updated OUTLINE DIMENSIONS	6
3/02 Data Sheet changed from REV. O to REV. A.	
Addition of Table I	1
Edits to ORDERING GUIDE	3
Addition of new text to ADM1813 and ADM1818 section	4

