



# Precision Low Drift 2.048 V/2.5 V/4.096 V/ 5.0 V SOT-23 Reference with Shutdown

## ADR390/ADR391/ADR392/ADR395

### FEATURES

Initial Accuracy:  $\pm 6$  mV Max  
Low  $TCV_O$ : 25 ppm/ $^{\circ}$ C Max  
Load Regulation: 60 ppm/mA  
Line Regulation: 25 ppm/V  
Low Supply Headroom: 0.3 V  
Wide Operating Range: ( $V_{OUT} + 0.3$  V) to 15 V  
Low Power: 120  $\mu$ A Max  
Shutdown to Less Than 3  $\mu$ A Max  
Output Current: 5 mA  
Wide Temperature Range:  
–40 $^{\circ}$ C to +85 $^{\circ}$ C for ADR390, ADR391  
–40 $^{\circ}$ C to +125 $^{\circ}$ C for ADR392, ADR395  
Tiny 5-Lead SOT-23 Package

### APPLICATIONS

Battery-Powered Instrumentation  
Portable Medical Instruments  
Data Acquisition Systems  
Industrial Process Control Systems  
Fault Protection Critical Systems  
Automotive

### GENERAL DESCRIPTION

The ADR390, ADR391, ADR392, and ADR395 are precision 2.048 V, 2.5 V, 4.096 V, and 5 V band gap voltage references featuring high accuracy and stability and low power consumption in a tiny footprint. Patented temperature drift curvature correction techniques minimize nonlinearity of the voltage change with temperature. The wide operating range and low power consumption with additional shutdown capability make them ideal for battery-powered applications. The  $V_{OUT}$  Sense Pin enables greater accuracy by supporting full Kelvin operation in PCBs employing thin or long traces.

The ADR390, ADR391, ADR392, and ADR395 are micropower, low dropout voltage (LDV) devices that provide a stable output voltage from supplies as low as 300 mV above the output voltage. ADR390 and ADR391 are specified over the industrial range (–40 $^{\circ}$ C to +85 $^{\circ}$ C), while ADR392 and ADR395 are specified over the extended industrial range (–40 $^{\circ}$ C to +125 $^{\circ}$ C). Each is available in the tiny 5-lead SOT-23 package.

The combination of  $V_{OUT}$  sense and shutdown functions also enables a number of unique applications combining precision reference/regulation with fault decision and overcurrent protection. Details are provided in the Applications section.

### PIN CONFIGURATION

5-Lead SOT-23  
(RT Suffix)

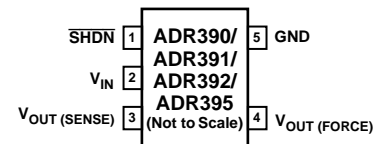

Table I. ADR39x Products

Part Number	Nominal Output Voltage (V)
ADR390	2.048
ADR391	2.500
ADR392	4.096
ADR395	5.000

### REV. C

Information furnished by Analog Devices is believed to be accurate and reliable. However, no responsibility is assumed by Analog Devices for its use, nor for any infringements of patents or other rights of third parties that may result from its use. No license is granted by implication or otherwise under any patent or patent rights of Analog Devices.

# ADR390/ADR391/ADR392/ADR395

## ADR390 SPECIFICATIONS

### ELECTRICAL CHARACTERISTICS (@ $V_S = 5.0\text{ V to }15\text{ V}$ , $T_A = 25^\circ\text{C}$ , unless otherwise noted.)

Parameter	Symbol	Conditions	Min	Typ	Max	Unit
Initial Accuracy	$V_O$		2.042	2.048	2.054	V
Initial Accuracy Error	$V_{OERR}$		0.29		0.29	%
Temperature Coefficient	$TCV_O$	$-40^\circ\text{C} < T_A < +85^\circ\text{C}$		5	25	ppm/ $^\circ\text{C}$
Minimum Supply Voltage Headroom	$V_{IN} - V_O$		300			mV
Line Regulation	$\Delta V_O / \Delta V_{IN}$	$V_{IN} = 2.5\text{ V to }15\text{ V}$ $-40^\circ\text{C} < T_A < +85^\circ\text{C}$		10	25	ppm/V
Load Regulation	$\Delta V_O / \Delta I_{LOAD}$	$V_{IN} = 3\text{ V}$ , $I_{LOAD} = 0\text{ mA to }5\text{ mA}$ $-40^\circ\text{C} < T_A < +85^\circ\text{C}$			60	ppm/mA
Quiescent Current	$I_{SY}$	No Load $-40^\circ\text{C} < T_A < +85^\circ\text{C}$		100	120	$\mu\text{A}$
Voltage Noise	$e_N$	0.1 Hz to 10 Hz		5		$\mu\text{V p-p}$
Turn-On Settling Time	$t_R$			20		$\mu\text{s}$
Long-Term Stability*	$\Delta V_O$			50		ppm/1000 hrs
Output Voltage Hysteresis	$V_{O\_HYS}$			40		ppm
Ripple Rejection Ratio	RRR	$f_{IN} = 60\text{ Hz}$		85		dB
Short Circuit to GND	$I_{SC}$	$V_{IN} = 5.0\text{ V}$ $V_{IN} = 15.0\text{ V}$		25		mA
Shutdown Supply Current	$I_{SHDN}$				3	$\mu\text{A}$
Shutdown Logic Input Current	$I_{LOGIC}$				500	nA
Shutdown Logic Low	$V_{INL}$				0.8	V
Shutdown Logic High	$V_{INH}$		2.4			V

\*The long-term stability specification is noncumulative. The drift in subsequent 1000 hour periods is significantly lower than in the first 1000 hour period. Specifications subject to change without notice.

## ADR391 SPECIFICATIONS

### ELECTRICAL CHARACTERISTICS (@ $V_S = 5.0\text{ V to }15\text{ V}$ , $T_A = 25^\circ\text{C}$ , unless otherwise noted.)

Parameter	Symbol	Conditions	Min	Typ	Max	Unit
Initial Accuracy	$V_O$		2.494	2.5	2.506	V
Initial Accuracy Error	$V_{OERR}$		0.24		0.24	%
Temperature Coefficient	$TCV_O$	$-40^\circ\text{C} < T_A < +85^\circ\text{C}$		5	25	ppm/ $^\circ\text{C}$
Minimum Supply Voltage Headroom	$V_{IN} - V_O$		300			mV
Line Regulation	$\Delta V_O / \Delta V_{IN}$	$V_{IN} = 2.8\text{ V to }15\text{ V}$ $-40^\circ\text{C} < T_A < +85^\circ\text{C}$		10	25	ppm/V
Load Regulation	$\Delta V_O / \Delta I_{LOAD}$	$V_{SY} = 3.5\text{ V}$ , $I_{LOAD} = 0\text{ mA to }5\text{ mA}$ $-40^\circ\text{C} < T_A < +85^\circ\text{C}$			60	ppm/mA
Quiescent Current	$I_{SY}$	No Load $-40^\circ\text{C} < T_A < +85^\circ\text{C}$		100	120	$\mu\text{A}$
Voltage Noise	$e_N$	0.1 Hz to 10 Hz		5		$\mu\text{V p-p}$
Turn-On Settling Time	$t_R$			20		$\mu\text{s}$
Long-Term Stability*	$\Delta V_O$			50		ppm/1000 hrs
Output Voltage Hysteresis	$V_{O\_HYS}$			75		ppm
Ripple Rejection Ratio	RRR	$f_{IN} = 60\text{ Hz}$		85		dB
Short Circuit to GND	$I_{SC}$	$V_{IN} = 5.0\text{ V}$ $V_{IN} = 15.0\text{ V}$		25		mA
Shutdown Supply Current					3	$\mu\text{A}$
Shutdown Logic Input Current	$I_{LOGIC}$				500	nA
Shutdown Logic Low	$V_{INL}$				0.8	V
Shutdown Logic High	$V_{INH}$		2.4			V

\*The long-term stability specification is noncumulative. The drift in subsequent 1000 hour periods is significantly lower than in the first 1000 hour period. Specifications subject to change without notice.

## ADR392 SPECIFICATIONS

ELECTRICAL CHARACTERISTICS (@  $V_S = 5.0\text{ V}$  to  $15\text{ V}$ ,  $T_A = 25^\circ\text{C}$ , unless otherwise noted.)

Parameter	Symbol	Conditions	Min	Typ	Max	Unit
Initial Accuracy	$V_O$		4.090	4.096	4.912	V
Initial Accuracy Error	$V_{OERR}$		0.15		0.15	%
Temperature Coefficient	$TCV_O$	$-40^\circ\text{C} < T_A < +125^\circ\text{C}$		5	25	ppm/ $^\circ\text{C}$
Minimum Supply Voltage Headroom	$V_S - V_O$		300			mV
Line Regulation	$\Delta V_O / \Delta V_{IN}$	$V_{IN} = 4.4\text{ V to }15\text{ V}$ $-40^\circ\text{C} < T_A < +125^\circ\text{C}$		10	25	ppm/V
Load Regulation	$\Delta V_O / \Delta I_{LOAD}$	$V_{SY} = 5\text{ V}$ , $I_{LOAD} = 0\text{ mA to }5\text{ mA}$ $-40^\circ\text{C} < T_A < +125^\circ\text{C}$			140	ppm/mA
Quiescent Current	$I_{SY}$	No Load $-40^\circ\text{C} < T_A < +125^\circ\text{C}$		100	120	$\mu\text{A}$
Voltage Noise	$e_N$	0.1 Hz to 10 Hz		5	140	$\mu\text{V p-p}$
Turn-On Settling Time	$t_R$			20		$\mu\text{s}$
Long-Term Stability*	$\Delta V_O$			50		ppm/1000 hrs
Output Voltage Hysteresis	$V_{O\_HYS}$			75		ppm
Ripple Rejection	RRR	$f_{IN} = 60\text{ Hz}$		85		dB
Short Circuit to GND	$I_{SC}$	$V_{IN} = 5.0\text{ V}$ $V_{IN} = 15.0\text{ V}$		25		mA
Shutdown Supply Current					3	$\mu\text{A}$
Shutdown Logic Input Current	$I_{LOGIC}$				500	nA
Shutdown Logic Low	$V_{INL}$				0.8	V
Shutdown Logic High	$V_{INH}$		2.4			V

\*The long-term stability specification is noncumulative. The drift in subsequent 1000 hour periods is significantly lower than in the first 1000 hour period. Specifications subject to change without notice.

## ADR395 SPECIFICATIONS

ELECTRICAL CHARACTERISTICS (@  $V_S = 6.0\text{ V}$  to  $15\text{ V}$ ,  $T_A = 25^\circ\text{C}$ , unless otherwise noted.)

Parameter	Symbol	Conditions	Min	Typ	Max	Unit
Initial Accuracy	$V_O$		4.994	5.000	5.006	V
Initial Accuracy Error	$V_{OERR}$		0.12		0.12	%
Temperature Coefficient	$TCV_O$	$-40^\circ\text{C} < T_A < +125^\circ\text{C}$		5	25	ppm/ $^\circ\text{C}$
Minimum Supply Voltage Headroom	$V_S - V_O$		300			mV
Line Regulation	$\Delta V_O / \Delta V_{IN}$	$V_{IN} = 5.3\text{ V to }15\text{ V}$ $-40^\circ\text{C} < T_A < +125^\circ\text{C}$		10	30	ppm/V
Load Regulation	$\Delta V_O / \Delta I_{LOAD}$	$V_{SY} = 6\text{ V}$ , $I_{LOAD} = 0\text{ mA to }5\text{ mA}$ $-40^\circ\text{C} < T_A < +125^\circ\text{C}$			140	ppm/mA
Quiescent Current	$I_{SY}$	No Load $-40^\circ\text{C} < T_A < +125^\circ\text{C}$		100	120	$\mu\text{A}$
Voltage Noise	$e_N$	0.1 Hz to 10 Hz		5	140	$\mu\text{V p-p}$
Turn-On Settling Time	$t_R$			20		$\mu\text{s}$
Long-Term Stability*	$\Delta V_O$			50		ppm/1000 hrs
Output Voltage Hysteresis	$V_{O\_HYS}$			75		ppm
Ripple Rejection	RRR	$f_{IN} = 60\text{ Hz}$		85		dB
Short Circuit to GND	$I_{SC}$	$V_{IN} = 5.0\text{ V}$ $V_{IN} = 15.0\text{ V}$		25		mA
Shutdown Supply Current					3	$\mu\text{A}$
Shutdown Logic Input Current	$I_{LOGIC}$				500	nA
Shutdown Logic Low	$V_{INL}$				0.8	V
Shutdown Logic High	$V_{INH}$		2.4			V

\*The long-term stability specification is noncumulative. The drift in subsequent 1000 hour periods is significantly lower than in the first 1000 hour period. Specifications subject to change without notice.

# ADR390/ADR391/ADR392/ADR395

## ABSOLUTE MAXIMUM RATINGS<sup>1, 2</sup>

Supply Voltage	18 V
Output Short-Circuit Duration to GND	Observe Derating Curves
Storage Temperature Range RT Package	-65°C to +150°C
Operating Temperature Range ADR390/ADR391	-40°C to +85°C
ADR392/ADR395	-40°C to +125°C
Junction Temperature Range RT Package	-65°C to +150°C
Lead Temperature Range (Soldering, 60 Sec)	300°C

Package Type	$\theta_{JA}$	$\theta_{JC}$	Unit
5-Lead SOT-23 (RT)	230		°C/W

### NOTES

<sup>1</sup> Absolute Maximum Ratings apply at 25°C, unless otherwise noted.

<sup>2</sup> Stresses above those listed under Absolute Maximum Ratings may cause permanent damage to the device. This is a stress rating only; functional operation of the device at these or any other conditions above those listed in the operational sections of this specification is not implied. Exposure to absolute maximum rating conditions for extended periods may affect device reliability.

## ORDERING GUIDE

Model	Temperature Range	Package Description	Package Option	Top Mark	Output Voltage	Number of Parts Per Reel
ADR390ART-RL7	-40°C to +85°C	5-Lead SOT-23	RT-5	R0A	2.048	3,000
ADR390ART-RL	-40°C to +85°C	5-Lead SOT-23	RT-5	R0A	2.048	10,000
ADR391ART-RL7	-40°C to +85°C	5-Lead SOT-23	RT-5	R1A	2.500	3,000
ADR391ART-RL	-40°C to +85°C	5-Lead SOT-23	RT-5	R1A	2.500	10,000
ADR392ART-RL7	-40°C to +125°C	5-Lead SOT-23	RT-5	RCA	4.096	3,000
ADR392ART-RL	-40°C to +125°C	5-Lead SOT-23	RT-5	RCA	4.096	10,000
ADR395ART-RL7	-40°C to +125°C	5-Lead SOT-23	RT-5	RDA	5.000	3,000

## CAUTION

ESD (electrostatic discharge) sensitive device. Electrostatic charges as high as 4000 V readily accumulate on the human body and test equipment and can discharge without detection. Although the ADR390/ADR391/ADR392/ADR395 features proprietary ESD protection circuitry, permanent damage may occur on devices subjected to high energy electrostatic discharges. Therefore, proper ESD precautions are recommended to avoid performance degradation or loss of functionality.



## PARAMETER DEFINITION

### Temperature Coefficient (TCV<sub>O</sub>)

The change of output voltage over the operating temperature change and normalized by the output voltage at 25°C, expressed in ppm/°C. The equation follows:

$$TCV_O [ppm/°C] = \frac{V_O(T_2) - V_O(T_1)}{V_O(25°C) \times (T_2 - T_1)} \times 10^6$$

where:

$$V_O(25°C) = V_O \text{ at } 25°C$$

$$V_O(T_1) = V_O \text{ at temperature 1}$$

$$V_O(T_2) = V_O \text{ at temperature 2}$$

### Line Regulation ( $\Delta V_O/\Delta V_{IN}$ )

The change in output voltage due to a specified change in input voltage. It includes the effects of self-heating. Line regulation is expressed in either percent per volt, parts per million per volt, or microvolts per volt change in input voltage.

### Load Regulation ( $\Delta V_O/\Delta I_{LOAD}$ )

The change in output voltage due to a specified change in load current. It includes the effects of self-heating. Load regulation is expressed in either microvolts per milliampere, parts per million per milliampere, or  $\Omega$  of dc output resistance.

### Input Capacitor

Input capacitors are not required on the ADR39x. There is no limit for the value of the capacitor used on the input, but a 1  $\mu$ F to 10  $\mu$ F capacitor on the input will improve transient response in applications where the supply suddenly changes. An additional 0.1  $\mu$ F in parallel will also help in reducing noise from the supply.

### Output Capacitor

The ADR39x does not need output capacitors for stability under any load condition. An output capacitor, typically 0.1  $\mu$ F, will filter out any low level noise voltage and will not affect the operation of the part. On the other hand, the load transient

response can be improved with an additional 1  $\mu$ F to 10  $\mu$ F output capacitor in parallel. A capacitor here will act as a source of stored energy for a sudden increase in load current. The only parameter that will degrade, by adding an output capacitor, is turn-on time and it depends on the size of the capacitor chosen.

### Long-Term Stability

Typical shift in output voltage over 1000 hours at a controlled temperature. Figure 1 shows a sample of parts measured at different intervals in a controlled environment of 50°C for 1000 hours.

$$\Delta V_O = V_O(t_0) - V_O(t_1)$$

$$\Delta V_O [ppm] = \frac{V_O(t_0) - V_O(t_1)}{V_O(t_0)} \times 10^6$$

where:

$$V_O(t_0) = V_O \text{ at time 0}$$

$$V_O(t_1) = V_O \text{ after 1000 hours operation at a controlled temperature}$$

### Thermal Hysteresis ( $V_{O\_HYS}$ )

The change of output voltage after the device is cycled through temperature from +25°C to -40°C to +85°C and back to +25°C. This is a typical value from a sample of parts put through such a cycle.

$$V_{O\_HYS} = V_O(25°C) - V_{O\_TC}$$

$$V_{O\_HYS} [ppm] = \frac{V_O(25°C) - V_{O\_TC}}{V_O(25°C)} \times 10^6$$

where:

$$V_O(25°C) = V_O \text{ at } 25°C$$

$$V_{O\_TC} = V_O \text{ at } 25°C \text{ after temperature cycle at } +25°C \text{ to } -40°C \text{ to } +85°C \text{ and back to } +25°C$$

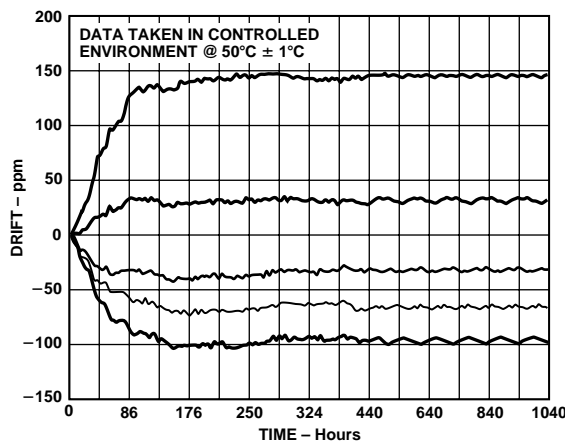
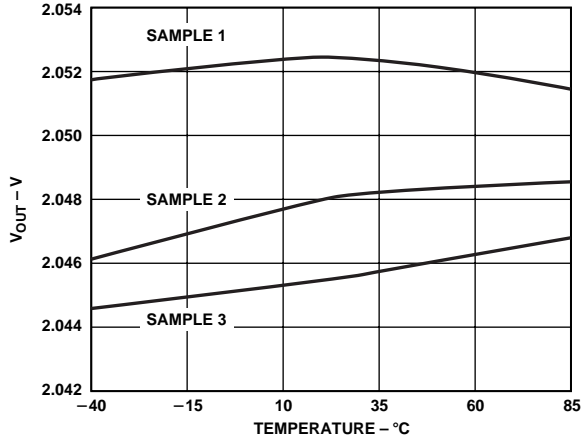
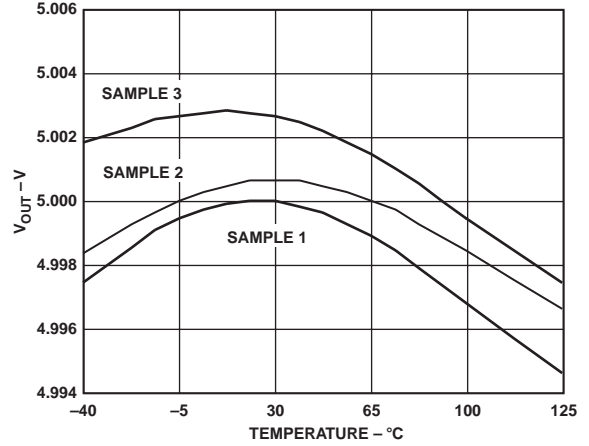

Figure 1. ADR391 Typical Long-Term Drift over 1000 Hours

# ADR390/ADR391/ADR392/ADR395 – Typical Performance Characteristics



TPC 1. ADR390 Output Voltage vs. Temperature



TPC 4. ADR395 Output Voltage vs. Temperature

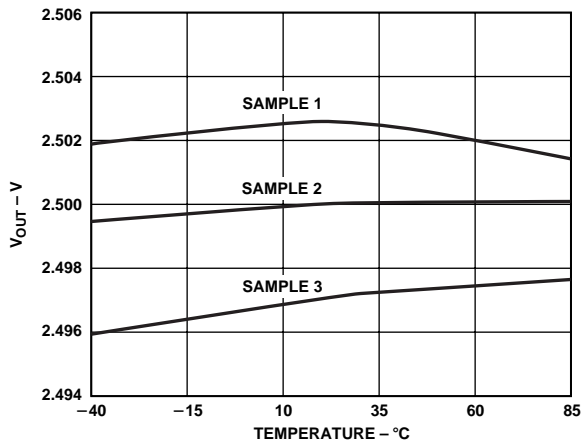

TPC 2. ADR391 Output Voltage vs. Temperature

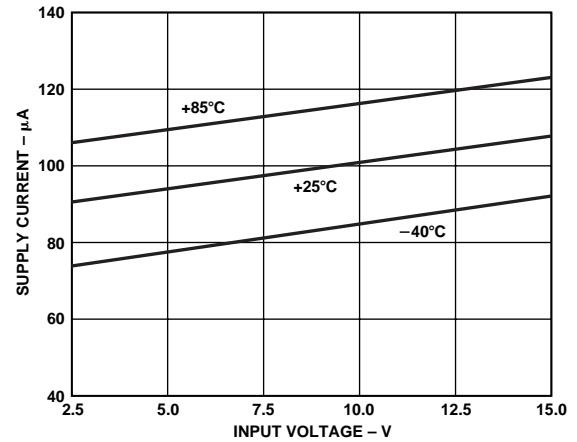

TPC 5. ADR390 Supply Current vs. Input Voltage

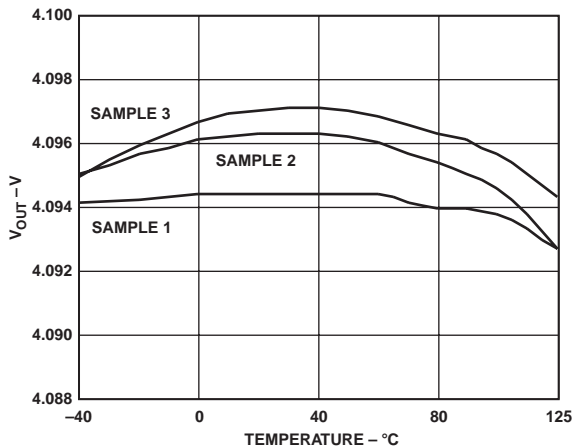

TPC 3. ADR392 Output Voltage vs. Temperature

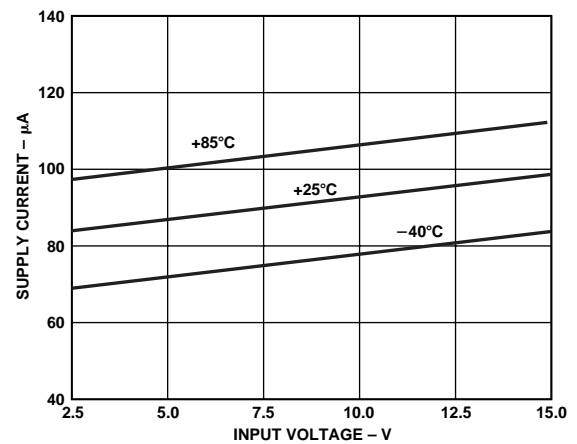

TPC 6. ADR391 Supply Current vs. Input Voltage

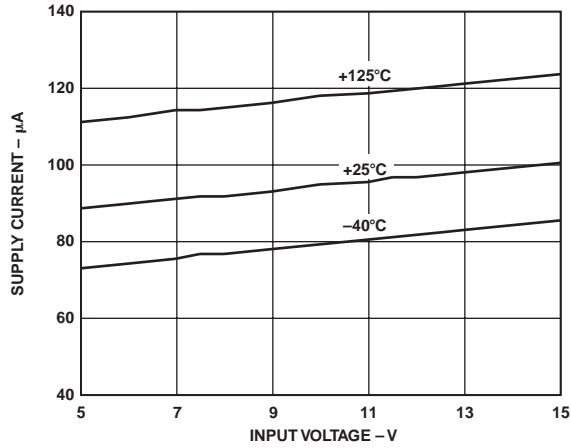

TPC 7. ADR392 Supply Current vs. Input Voltage

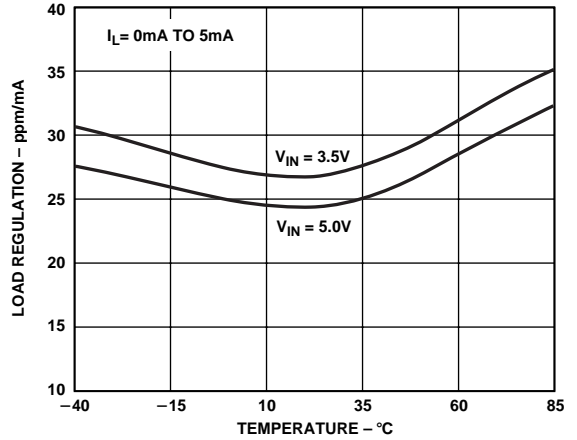

TPC 10. ADR391 Load Regulation vs. Temperature

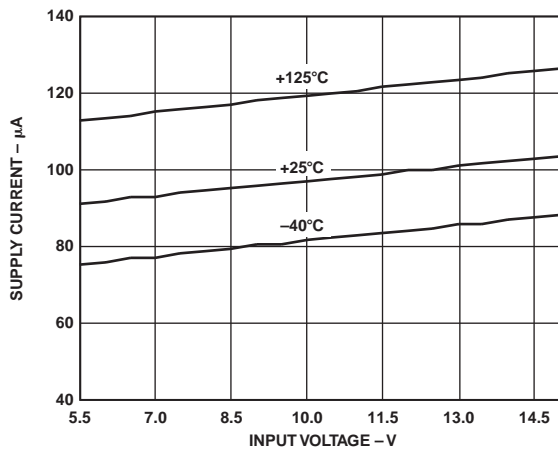

TPC 8. ADR395 Supply Current vs. Input Voltage

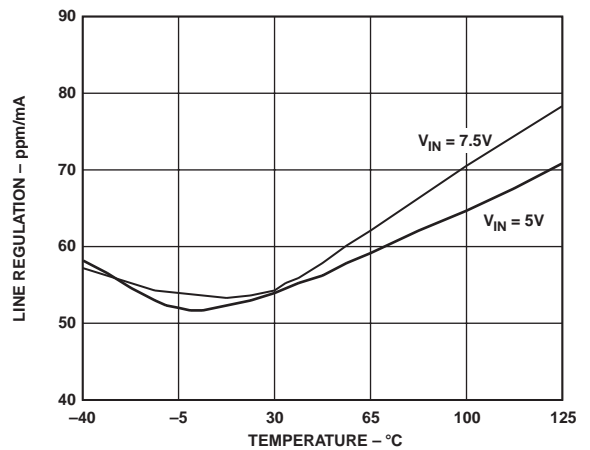

TPC 11. ADR392 Load Regulation vs. Temperature

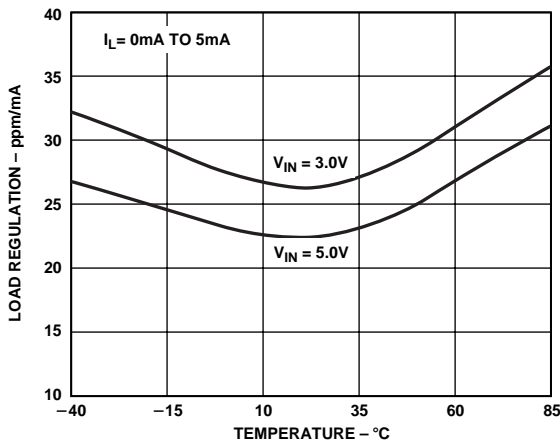

TPC 9. ADR390 Load Regulation vs. Temperature

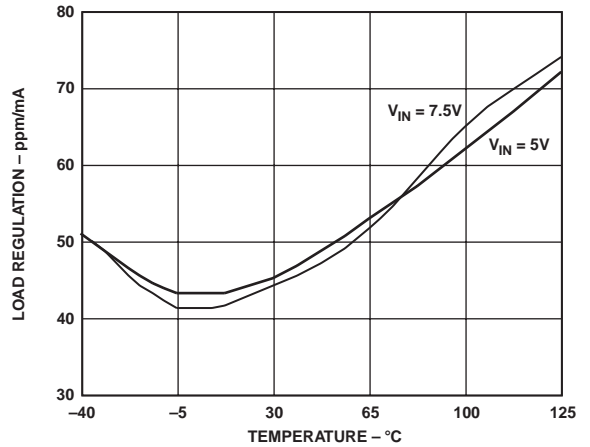

TPC 12. ADR395 Load Regulation vs. Temperature

# ADR390/ADR391/ADR392/ADR395

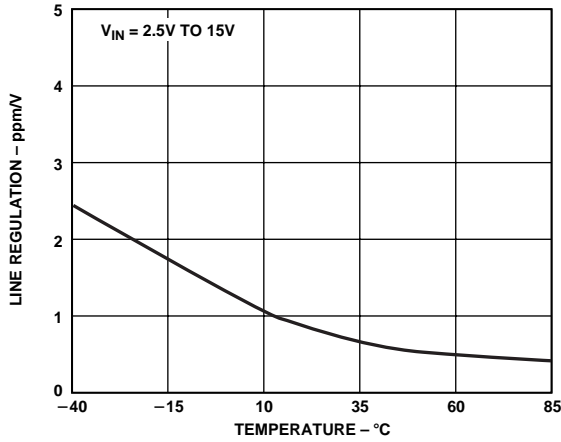

TPC 13. ADR390 Line Regulation vs. Temperature

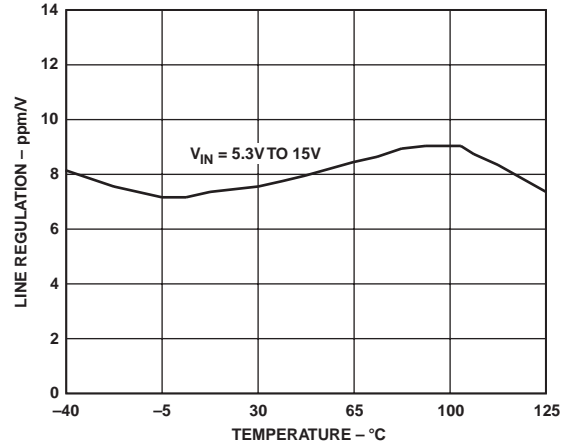

TPC 16. ADR395 Line Regulation vs. Temperature

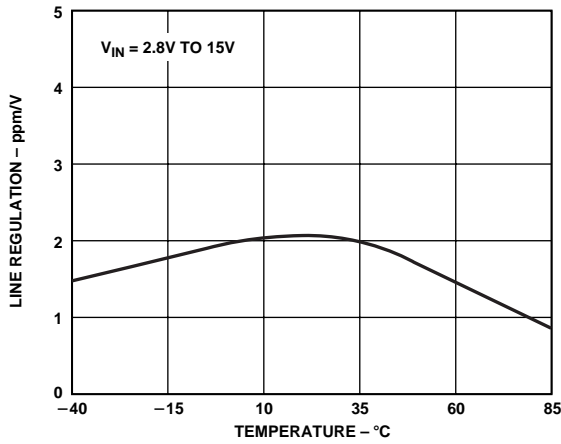

TPC 14. ADR391 Line Regulation vs. Temperature

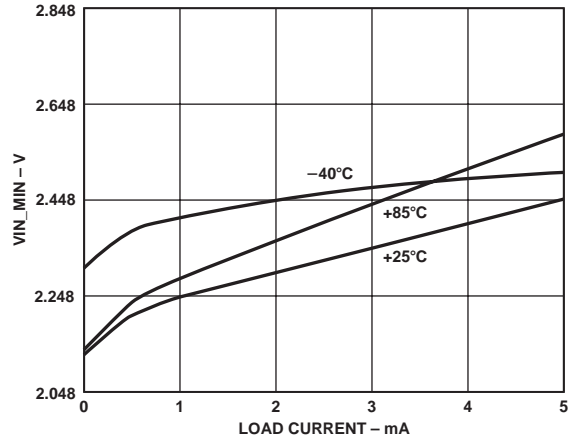

TPC 17. ADR390 Minimum Input Voltage vs. Load Current

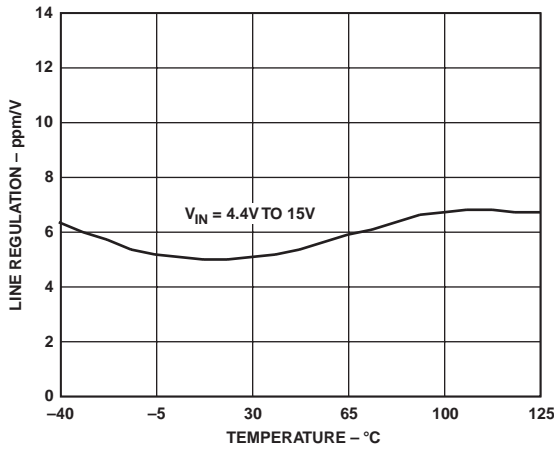

TPC 15. ADR392 Line Regulation vs. Temperature

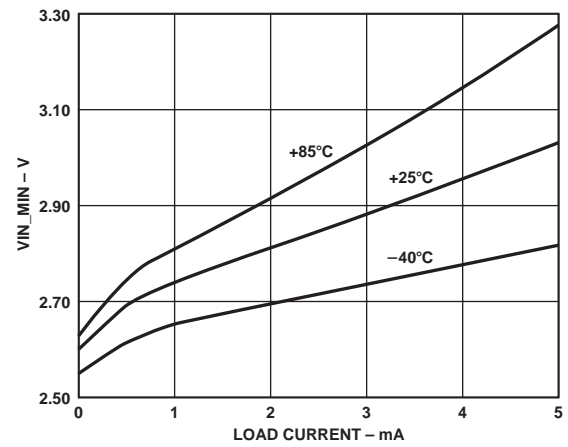

TPC 18. ADR391 Minimum Input Voltage vs. Load Current



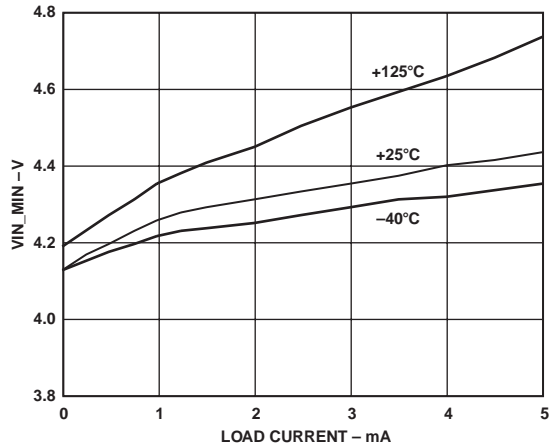

TPC 19. ADR392 Minimum Input Voltage vs. Load Current

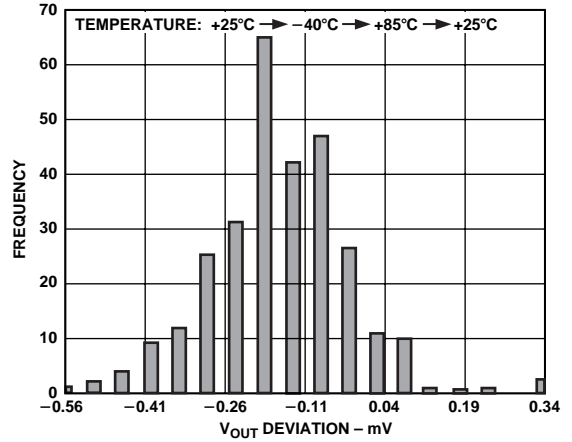

TPC 22. ADR391  $V_{OUT}$  Hysteresis Distribution

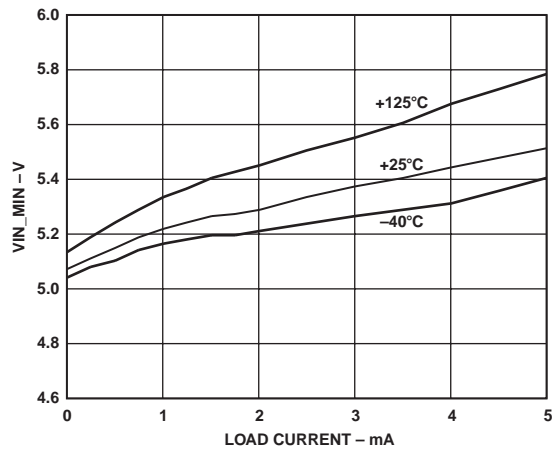

TPC 20. ADR395 Minimum Input Voltage vs. Load Current

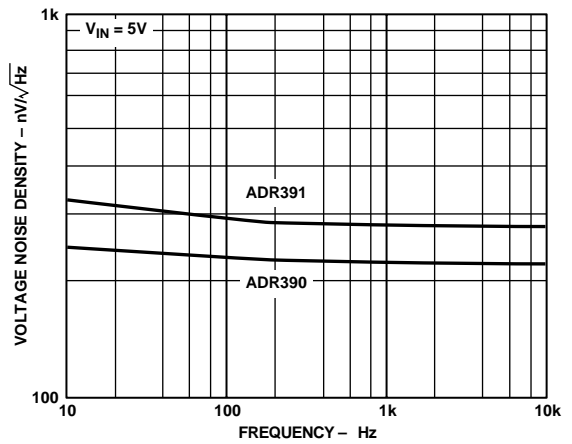

TPC 23. Voltage Noise Density vs. Frequency

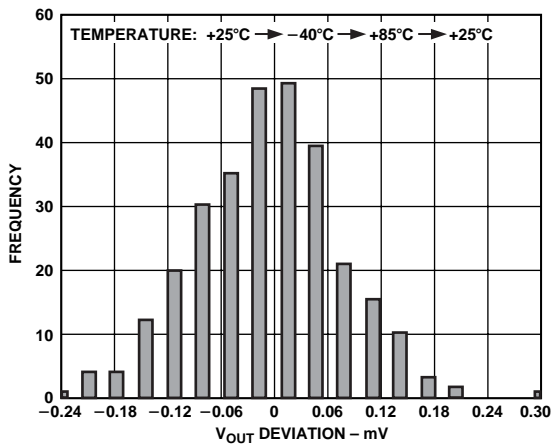

TPC 21. ADR390  $V_{OUT}$  Hysteresis Distribution

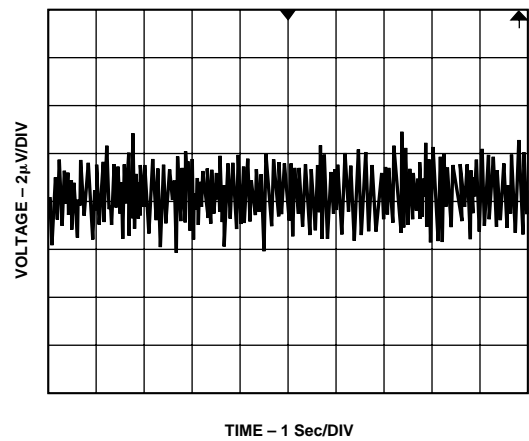

TPC 24. ADR391 Typical Voltage Noise 0.1 Hz to 10 Hz

# ADR390/ADR391/ADR392/ADR395

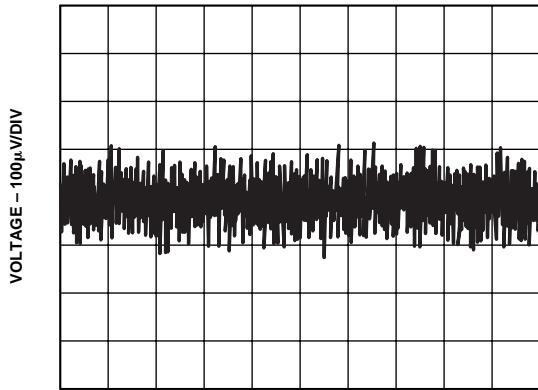

TPC 25. ADR391 Voltage Noise 10 Hz to 10 kHz

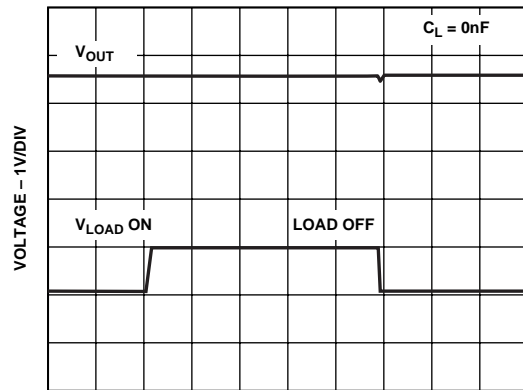

TPC 28. ADR391 Load Transient Response

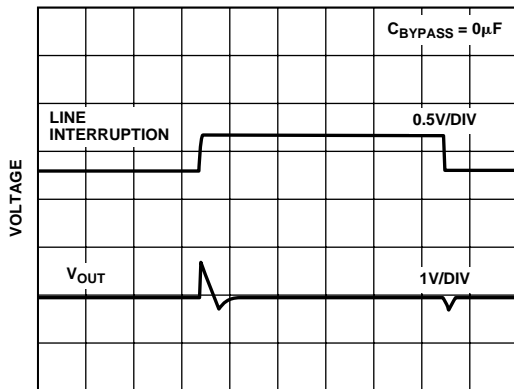

TPC 26. ADR391 Line Transient Response

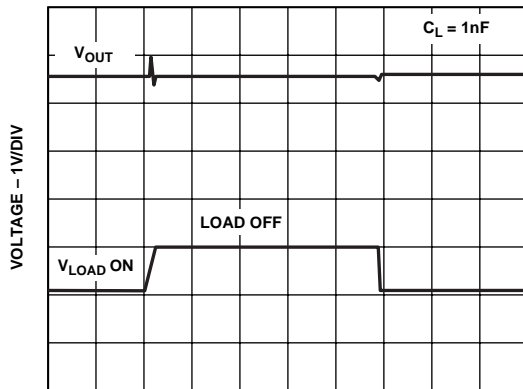

TPC 29. ADR391 Load Transient Response

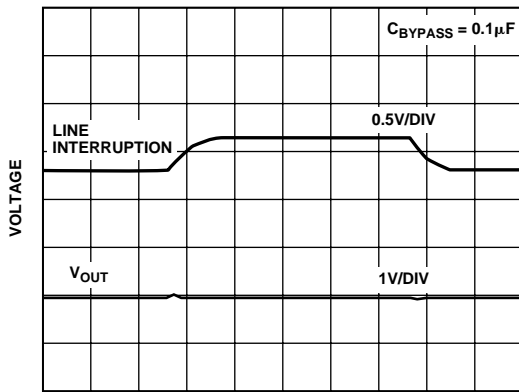

TPC 27. ADR391 Line Transient Response

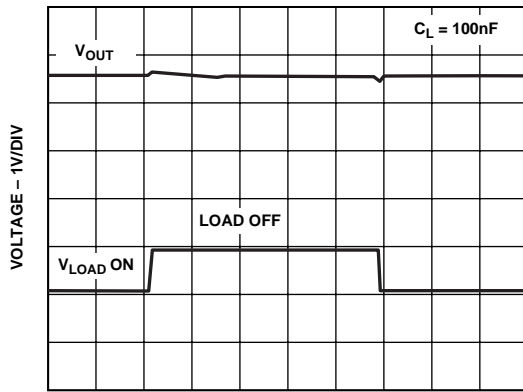

TPC 30. ADR391 Load Transient Response

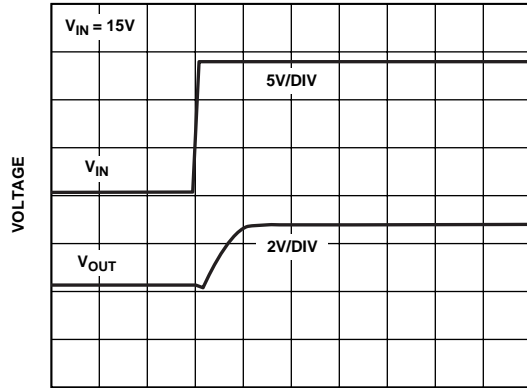

TIME – 20 $\mu$ s/DIV

TPC 31. ADR391 Turn-On Response Time at 15 V

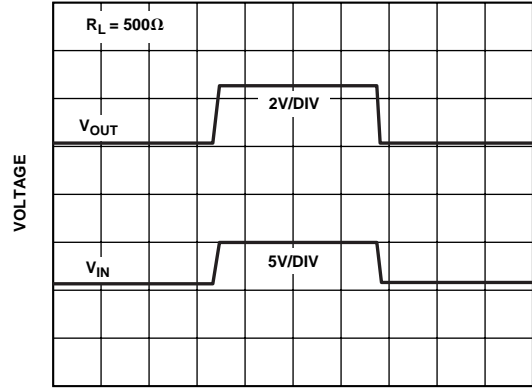

TIME – 200 $\mu$ s/DIV

TPC 34. ADR391 Turn-On/Turn-Off Response at 5 V

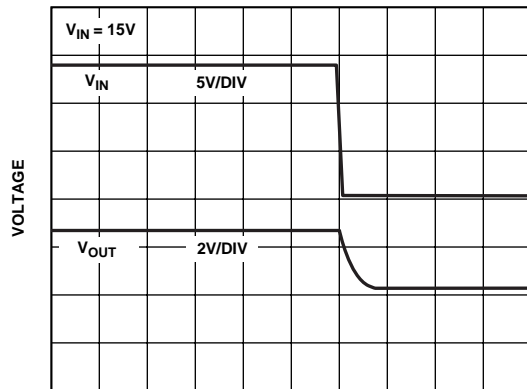

TIME – 40 $\mu$ s/DIV

TPC 32. ADR391 Turn-Off Response at 15 V

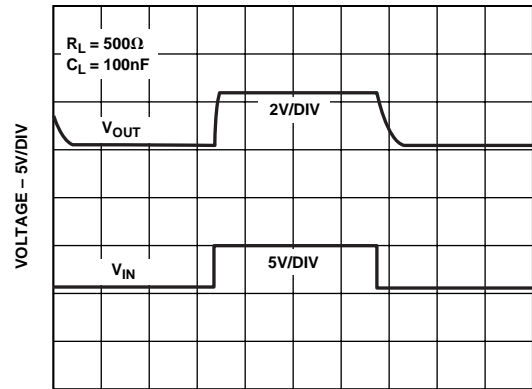

TIME – 200 $\mu$ s/DIV

TPC 35. ADR391 Turn-On/Turn-Off Response at 5 V

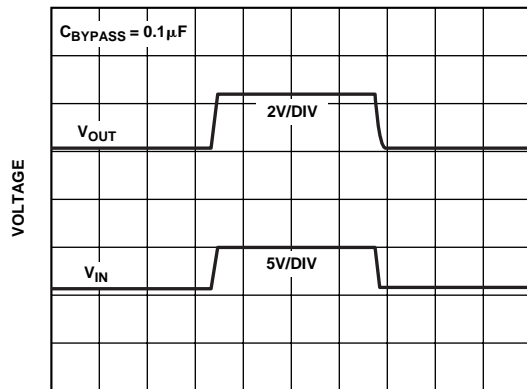

TIME – 200 $\mu$ s/DIV

TPC 33. ADR391 Turn-On/Turn-Off Response at 5 V

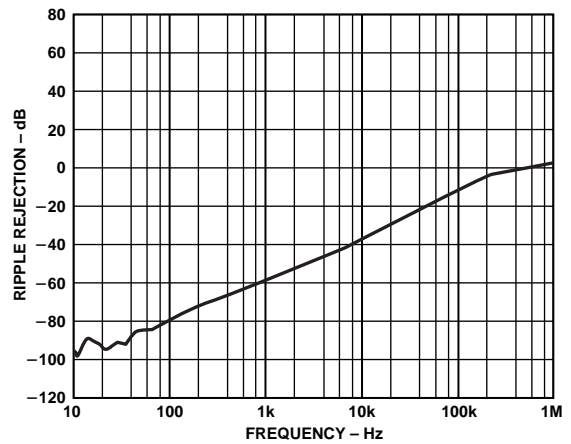

TPC 36. Ripple Rejection vs. Frequency

# ADR390/ADR391/ADR392/ADR395

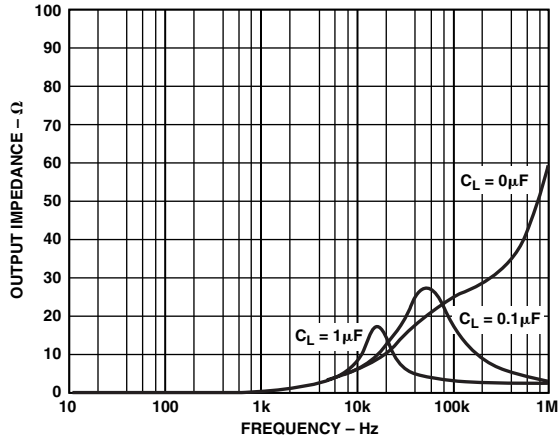

TPC 37. Output Impedance vs. Frequency

## THEORY OF OPERATION

Band gap references are the high performance solution for low supply voltage and low power voltage reference applications, and the ADR390/ADR391/ADR392/ADR395 is no exception. The uniqueness of this product lies in its architecture. By observing Figure 2, the ideal zero TC band gap voltage is referenced to the output, not to ground. Therefore, if noise exists on the ground line, it will be greatly attenuated on  $V_{OUT}$ . The band gap cell consists of the pnp pair Q51 and Q52, running at unequal current densities. The difference in  $V_{BE}$  results in a voltage with a

positive TC, which is amplified by the ratio of  $2 \times \frac{R58}{R54}$ . This

PTAT voltage, combined with  $V_{BE}$ s of Q51 and Q52, produces the stable band gap voltage.

Reduction in the band gap curvature is performed by the ratio of the resistors R44 and R59, one of which is linearly temperature dependent. Precision laser trimming and other patented circuit techniques are used to further enhance the drift performance.

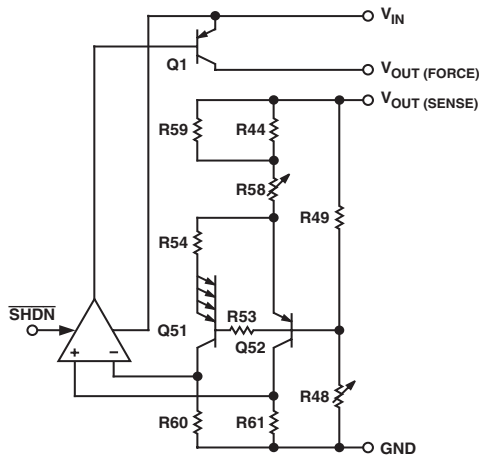

Figure 2. Simplified Schematic

## Device Power Dissipation Considerations

The ADR390/ADR391/ADR392/ADR395 is capable of delivering load currents to 5 mA with an input voltage that ranges from 2.8 V (ADR391 only) to 15 V. When this device is used in applications with large input voltages, care should be taken to avoid exceeding the specified maximum power dissipation or junction temperature that could result in premature device failure. The following formula should be used to calculate a device's maximum junction temperature or dissipation:

$$P_D = \frac{T_J - T_A}{\theta_{JA}}$$

In this equation,  $T_J$  and  $T_A$  are, respectively, the junction and ambient temperatures,  $P_D$  is the device power dissipation, and  $\theta_{JA}$  is the device package thermal resistance.

## Shutdown Mode Operation

The ADR390/ADR391/ADR392/ADR395 includes a shutdown feature that is TTL/CMOS level compatible. A logic LOW or a zero volt condition on the  $\overline{\text{SHDN}}$  Pin is required to turn the device off. During shutdown, the output of the reference becomes a high impedance state where its potential would then be determined by external circuitry. If the shutdown feature is not used, the  $\overline{\text{SHDN}}$  Pin should be connected to  $V_{IN}$  (Pin 2).

## APPLICATIONS

### BASIC VOLTAGE REFERENCE CONNECTION

The circuit in Figure 3 illustrates the basic configuration for the ADR39x family. Decoupling capacitors are not required for circuit stability. The ADR39x family is capable of driving capacitive loads from 0  $\mu\text{F}$  to 10  $\mu\text{F}$ . However, a 0.1  $\mu\text{F}$  ceramic output capacitor is recommended to absorb and deliver the charge as is required by a dynamic load.

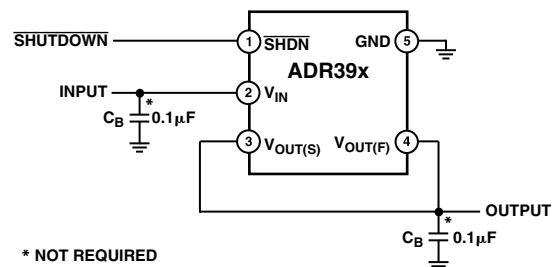

Figure 3. Basic Configuration for the ADR39x Family

### Stacking Reference ICs for Arbitrary Outputs

Some applications may require two reference voltage sources, which are a combined sum of standard outputs. Figure 4 circuit shows how this "stacked output" reference can be implemented:

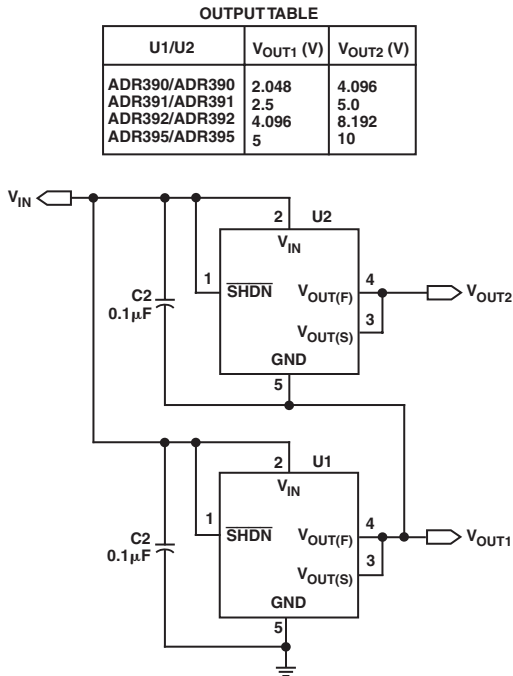

Figure 4. Stacking Voltage References with the ADR390/ADR391/ADR392/ADR395

Two reference ICs are used, fed from an unregulated input,  $V_{IN}$ . The outputs of the individual ICs are simply connected in series, which provides two output voltages  $V_{OUT1}$  and  $V_{OUT2}$ .  $V_{OUT1}$  is the terminal voltage of U1, while  $V_{OUT2}$  is the sum of this voltage and the terminal voltage of U2. U1 and U2 are simply chosen for the two voltages that supply the required outputs (see Output Table). For example, if both U1 and U2 are ADR391s,  $V_{OUT1}$  is 2.5 V and  $V_{OUT2}$  is 5.0 V.

While this concept is simple, a precaution is in order. Since the lower reference circuit must sink a small bias current from U2, plus the base current from the series PNP output transistor in U2, either the external load of U1 or R1 must provide a path for this current. If the U1 minimum load is not well defined, the resistor R1 should be used, set to a value that will conservatively pass 600  $\mu$ A of current with the applicable  $V_{OUT1}$  across it. Note that the two U1 and U2 reference circuits are locally treated as macrocells, each having its own bypasses at input and output for best stability. Both U1 and U2 in this circuit can source dc currents up to their full rating. The minimum input voltage,  $V_{IN}$ , is determined by the sum of the outputs,  $V_{OUT2}$ , plus the drop-out voltage of U2.

### A Negative Precision Reference without Precision Resistors

A negative reference can be easily generated by adding an op amp, A1, and configured as shown in Figure 5.  $V_{OUTF}$  and  $V_{OUTS}$  are at virtual ground and therefore the negative reference can be taken directly from the output of the op amp. The op amp must be dual supply, low offset, and rail-to-rail if the negative supply voltage is close to the reference output.

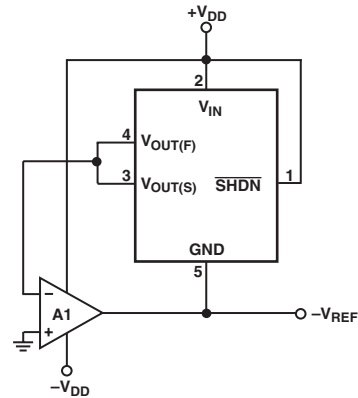

Figure 5. Negative Reference

### General-Purpose Current Source

Many times in low power applications, the need arises for a precision current source that can operate on low supply voltages. As shown in Figure 6, the ADR390/ADR391/ADR392/ADR395 can be configured as a precision current source. The circuit configuration illustrated is a floating current source with a grounded load. The reference's output voltage is bootstrapped across  $R_{SET}$ , which sets the output current into the load. With this configuration, circuit precision is maintained for load currents in the range from the reference's supply current, typically 90  $\mu$ A to approximately 5 mA.

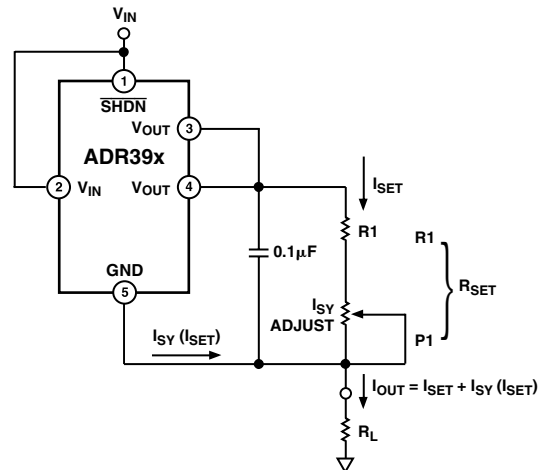

Figure 6. A General-Purpose Current Source

### High Power Performance with Current Limit

In some cases, the user may want higher output current delivered to a load and still achieve better than 0.5% accuracy out of the ADR39x. The accuracy for a reference is normally specified on the data sheet with no load. However, the output voltage changes with load current.

The circuit in Figure 7 provides high current without compromising the accuracy of the ADR39x. The series pass transistor Q1 provides up to 1 A load current. The ADR39x delivers only the base drive to Q1 through the force pin. The sense pin of the ADR39x is a regulated output and is connected to the load.

The transistor Q2 protects Q1 during short circuit limit faults by robbing its base drive. The maximum current is  $I_{LMAX} \approx 0.6 V/R_S$ .

# ADR390/ADR391/ADR392/ADR395

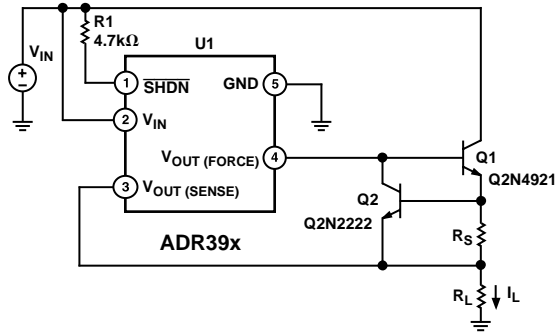

Figure 7. ADR39x for High Power Performance with Current Limit

A similar circuit function can also be achieved with the Darlington transistor configuration (see Figure 8).

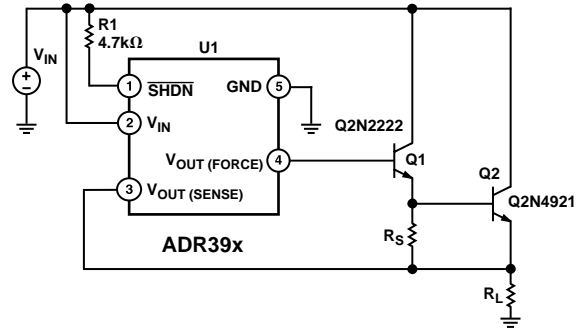
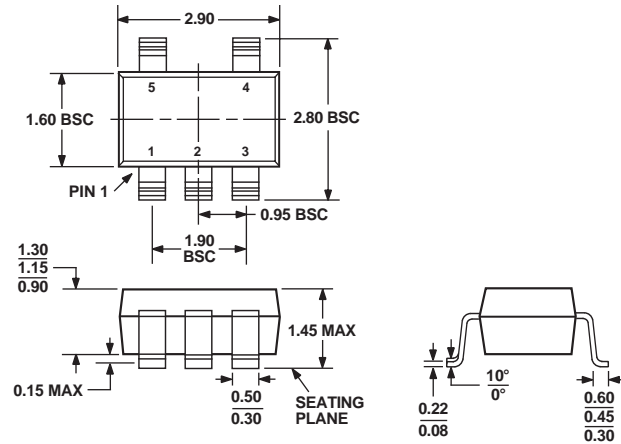

Figure 8. ADR39x High Output Current with Darlington Drive Configuration

OUTLINE DIMENSIONS

5-Lead Plastic Surface-Mount Package [SOT-23]  
(RT-5)

Dimensions shown in millimeters



COMPLIANT TO JEDEC STANDARDS MO-178AA

# ADR390/ADR391/ADR392/ADR395

## Revision History

<b>Location</b>	<b>Page</b>
<b>10/02—Data Sheet changed from REV. B to REV. C.</b>	
Add parts ADR392 and ADR395 .....	Universal
Changes to FEATURES .....	1
Changes to GENERAL DESCRIPTION .....	1
Additions to Table I .....	1
Changes to SPECIFICATIONS .....	2
Changes to ORDERING GUIDE .....	4
Changes to ABSOLUTE MAXIMUM RATINGS .....	4
New TPCs 3, 4, 7, 8, 11, 12, 15, 16, 19, and 20 .....	6
New Figures 4 and 5 .....	13
Deleted A Negative Precision Reference without Precision Resistors section .....	13
Edits to General-Purpose Current Source section .....	13
Updated OUTLINE DIMENSIONS .....	15
<b>5/02—Data Sheet changed from REV. A to REV. B.</b>	
Change to Figure 6 .....	13
Edits to layout .....	Universal

C00419-0-10/02(C)

PRINTED IN U.S.A.