

Description

The AH5775 is a single-chip solution for driving single-coil brushless direct current (BLDC) fans and motors. The integrated full-bridge driver output stage uses soft switching to minimize audible switching noise and electromagnetic interference (EMI) providing a low-noise solution.

To simplify system circuit and minimize external components, the device integrates a stable high-sensitivity Hall effect sensor, voltage and temperature compensated internal references, amplifiers and the output H-bridge power switches with low $R_{DS(ON)}$.

To help protect the motor coil, the AH5775 provides Rotor Lock Protection which shuts down the output drive if rotor lock is detected. The device automatically re-starts when the rotor lock is removed. In case of overvoltage, the device shuts down the output drive and enters standby mode to help prevent overvoltage stress on the coil. Over-temperature shutdown provides thermal protection for the device.

The AH5775 is available in TO94 package.

Features

- Supports single-phase full wave BLDC fan/motor drive
- Built-in Hall effect sensor and input amplifier
- Operating voltage: 2.5V to 18V
- Soft switching for low noise DC fan motor applications
- Rotor Lock Protection (Lock detection, output shutdown and automatic restart)
- Overvoltage shutdown
- Thermal protection
- No external timing capacitor - Reduces the numbers of external components required
- Industry Standard TO94 Package
- **Totally Lead-Free & Fully RoHS Compliant (Notes 1 & 2)**
- **Halogen and Antimony Free. "Green" Device (Note 3)**

Notes:

1. No purposely added lead. Fully EU Directive 2002/95/EC (RoHS) & 2011/65/EU (RoHS 2) compliant.
2. See http://www.diodes.com/quality/lead_free.html for more information about Diodes Incorporated's definitions of Halogen- and Antimony-free, "Green" and Lead-free.
3. Halogen- and Antimony-free "Green" products are defined as those which contain <900ppm bromine, <900ppm chlorine (<1500ppm total Br + Cl) and <1000ppm antimony compounds.

Pin Assignments

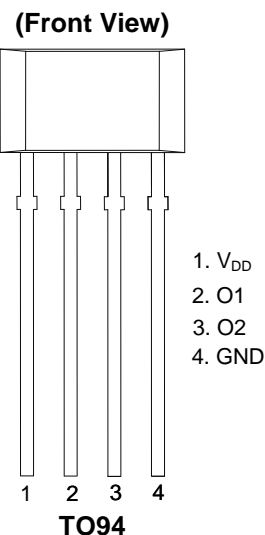

Applications

- 5V / 12V / 15V Min. BLDC Cooling Fans
- Netbook/ Notebook and Desktop BLDC fans
- Instruments Cooling Fans
- Medium Voltage/ Low Power BLDC Motors

Typical Applications Circuit (Notes 4)

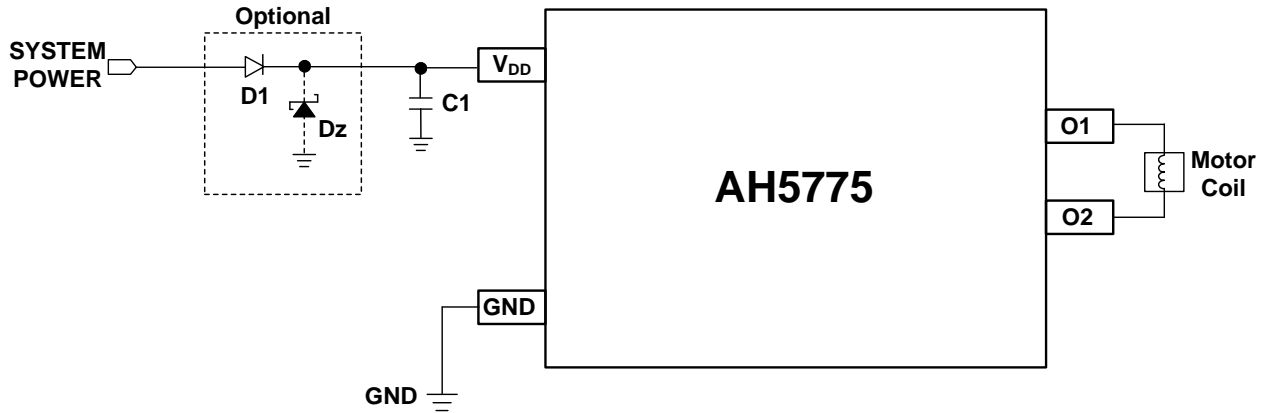

Note: 4. C1 is for power stabilization and to strengthen the noise immunity, the recommended capacitance is 0.1 μ F for small motor current to 1 μ F or higher for larger motor current and place capacitor as close to the V_{DD} pin as possible. The value of C1 should be selected adequately to support the motor current.

Pin Descriptions

Pin Number	Pin Name	Description
1	V _{DD}	Power supply input pin
2	O1	Output drive sourcing & sinking pin
3	O2	Output drive sourcing & sinking pin
4	GND	Ground pin

Functional Block Diagram

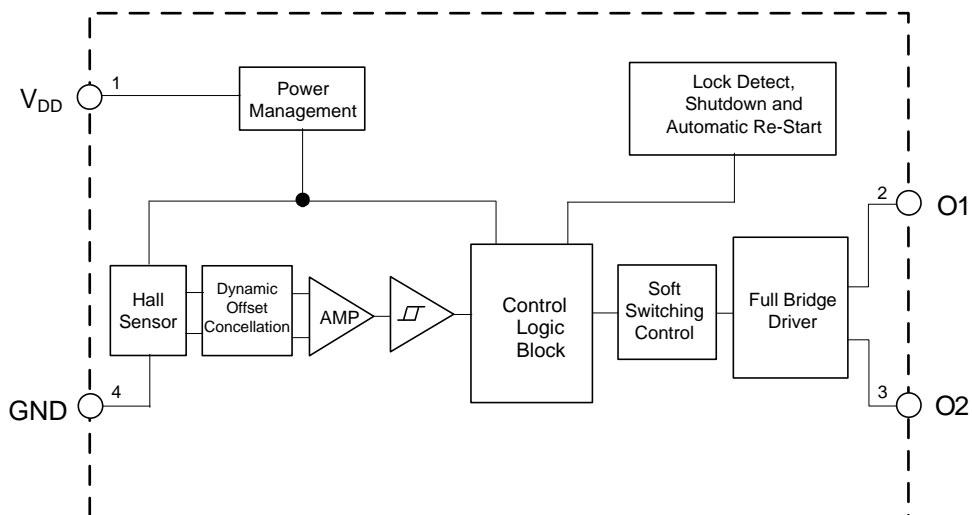

Absolute Maximum Ratings (Notes 5 & 6) (@T_A = +25°C, unless otherwise specified.)

Symbol	Characteristics	Values	Unit
V _{DD_MAX}	Maximum Supply Voltage (Note 6)	24	V
V _{REVERSE}	Reverse Supply Voltage on All Pins	-0.3	V
I _{O(CONT)}	Maximum Continuous Output Current	300	mA
I _{O(HOLD)}	Maximum Output Current (Hold) - Motor Lock Condition	500	mA
I _{O(PEAK)}	Maximum Output Current (Peak)	800	mA
B	Maximum Magnetic Flux Density	Unlimited	–
P _D	Power Dissipation	TO94	1,500 mW
T _{STG}	Storage Temperature Range	-65 to +150	°C
T _J	Maximum Junction Temperature	+150	°C
θ _{JA}	Thermal Resistance Junction-to-Ambient	86.3	°C/W
θ _{JC}	Thermal Resistance Junction-to-Case	8.25	°C/W
ESD HBM	Human Body Model ESD Capability	V _{DD} , O1, O2 and GND pins	4 kV

- Notes:
- Stresses greater than the 'Absolute Maximum Ratings' specified above may cause permanent damage to the device. These are stress ratings only; functional operation of the device at these or any other conditions exceeding those indicated in this specification is not implied. Device reliability may be affected by exposure to absolute maximum rating conditions for extended periods of time.
 - The absolute maximum V_{DD} of 24V is a transient stress rating and is not meant as a functional operating condition. It is not recommended to operate the device at the absolute maximum rated conditions for any period of time.

Recommended Operating Conditions

Symbol	Characteristic	Conditions	Min	Max	Unit
V _{DD}	Supply Voltage	Operating	2.5	18	V
T _A	Operating Temperature Range	Operating	-40	+105	°C

Electrical Characteristics (Note 7) (@T_A = +25°C, V_{DD} = 12V, unless otherwise specified.)

Symbol	Characteristics	Conditions	Min	Typ.	Max	Unit
I _{DD}	Supply Current	No Load, PWM switching or high	–	3.	4.5	mA
V _{OV_TH}	Overvoltage Protection Threshold for shutdown to standby mode	Voltage increasing	19	21	23	V
V _{OV_RLTH}	Overvoltage Release Threshold	Voltage decreasing	18	20	22	
V _{OH}	Output Voltage High	V _{DD} = 12V, I _{OUT} = 300mA	V _{DD} -0.35	V _{DD} -0.25	–	V
		V _{DD} = 12V, I _{OUT} = 300mA T _A = -40°C to +105°C	V _{DD} -0.45	V _{DD} -0.25	–	V
		V _{DD} = 3V, I _{OUT} = 200mA	V _{DD} -0.31	V _{DD} -0.2	–	V
		V _{DD} = 3V, I _{OUT} = 200mA T _A = -40°C to +105°C	V _{DD} -0.35	V _{DD} -0.2	–	V
V _{OL}	Output Voltage Low	V _{DD} = 12V, I _{OUT} = 300mA	–	0.2	0.25	V
		V _{DD} = 12V, I _{OUT} = 300mA T _A = -40°C to +105°C	–	0.2	0.3	V
		V _{DD} = 3V, I _{OUT} = 200mA	–	0.15	0.18	V
		V _{DD} = 3V, I _{OUT} = 200mA T _A = -40°C to +105°C	–	0.15	0.22	V

- Note: 7. Typical data is measured at T_A = +25°C, V_{DD} = 12V. The maximum and minimum parameters values over operating temperature range are not tested in production, they are guaranteed by design, characterization and process control.

Electrical Characteristics (continued) (Note 8) (@ $T_A = +25^\circ\text{C}$, $V_{DD} = 12\text{V}$, unless otherwise specified.)

Symbol	Characteristics	Conditions	Min	Typ.	Max	Unit
R _{ON_TOTAL}	Combined N- and PMOS R _{DSON} including bond wire resistance	V _{DD} = 12V, I _{OUT} = 300mA	–	1.5	2.41	Ω
		V _{DD} = 12V, I _{OUT} = 300mA T _A = -40°C to +105°C	–	1.5	2.7	Ω
		V _{DD} = 3V, I _{OUT} = 200mA	–	1.75	2.45	Ω
		V _{DD} = 3V, I _{OUT} = 200mA T _A = -40°C to +105°C	–	1.75	2.85	Ω
T _{SW}	Output Soft Switch Time	17Ω load on out1/out2	–	200	–	μs
T _{ON}	On Time - Lock Detect Time	–	–	420	–	ms
R _{DR}	Duty Ratio - Lock Detect to Shutdown time	T _{OFF} / T _{ON}	–	10	–	–
T _{J_SDN_TH}	IC junction temperature thermal shutdown threshold	–	–	+170	–	°C
T _{J_SDN_HYST}	IC junction temperature thermal shutdown hysteresis	–	–	+25	–	°C

Note: 8. Typical data is at $T_A = +25^\circ\text{C}$, $V_{DD} = 12\text{V}$. The maximum and minimum parameters values over operating temperature range are not tested in production, they are guaranteed by design, characterization and process control.

Magnetic Characteristics (Notes 9, 10 & 11) (@ $T_A = +25^\circ\text{C}$, $V_{DD} = 12\text{V}$, unless otherwise specified.)

(1mT = 10 G)

Symbol	Parameter	Conditions	Min	Typ	Max	Unit
B _{OP} (South Pole to Part Marking Side)	Operate Point	(Notes 10 & 11)	50	70	90	Gauss
B _{RP} (North Pole to Part Marking Side)	Release Point	(Notes 10 & 11)	-90	-70	-50	
B _{HY} (B _{OP} -B _{RP})	Hysteresis	–	–	140	–	

Notes: 9. Typical data is measured at $T_A = +25^\circ\text{C}$, $V_{DD} = 12\text{V}$. The maximum and minimum parameters values over operating temperature range are not tested in production, they are guaranteed by design, characterization and process control.

10. Magnetic characteristics may vary with supply voltage, operating temperature and after soldering.

11. The peak amplitude of the rotating motor magnetic flux density at the sensor location should be greater than +/-150G.

Operating Characteristics

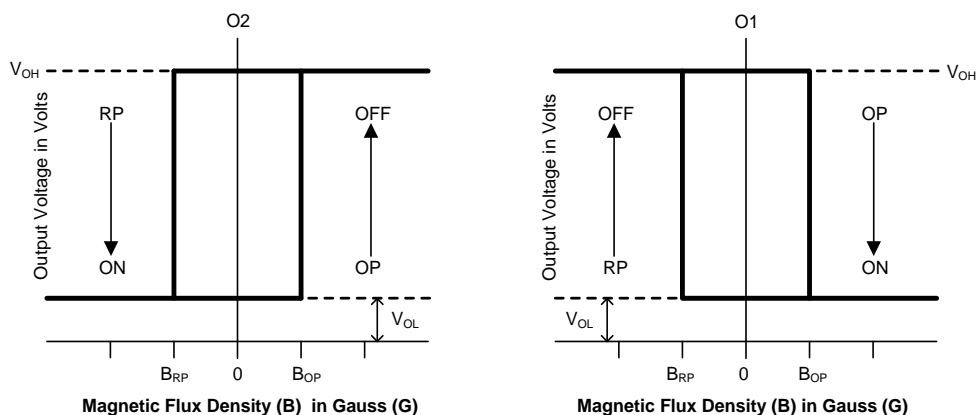

Operating Characteristics (continued) (Notes 12 & 13)

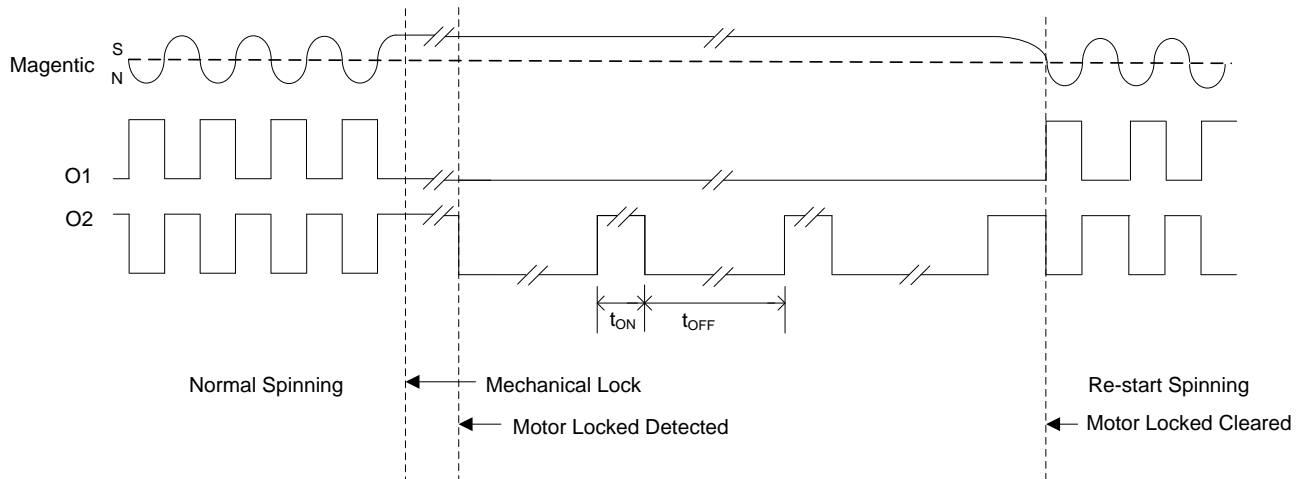
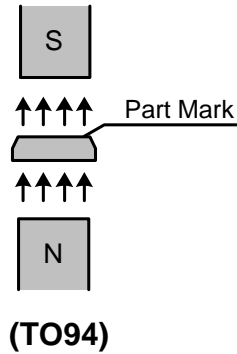

Truth Table

O1	O2	Magnetic Flux Density B
H	L	$B < B_{RP}$
L	H	$B > B_{OP}$

- Notes:
- When the motor locks with South pole at the Hall element, O2 is kept on "L" and O1 is a clock with t_{ON}/t_{OFF} ratio. When motor locks with North pole at the Hall element, O1 is kept on "L", O2 is a clock with t_{ON}/t_{OFF} ratio.
 - When "Re-start spinning" occurs, the motor speed ramps up to the "Normal Spinning" speed from zero. Speed ramp-up profile depends on motor characteristics.

Application Note

DC Supply Voltage Speed Control

Motor speed can be controlled by varying the V_{DD} supply voltage. For example, with 12V nominal motor, changing supply voltage between 12V to 2.5V, speed can be reduced from 100% to 20.8% typically.

Soft Switching

AH5775 uses soft switching of the motor coil current during commutation to minimize audible switching noise and electromagnetic interference (EMI).

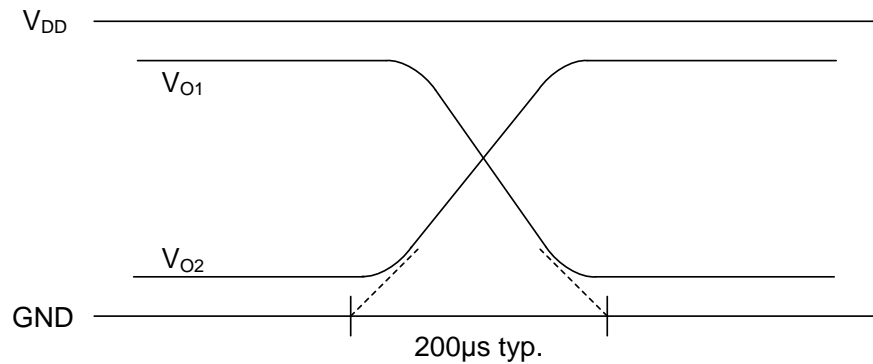

Overvoltage Shutdown of Output Drive

When the supply voltage reaches the overvoltage shutdown threshold, V_{OV_TH} , the AH5775 shuts down all the output drive switches and enters standby mode to help prevent overvoltage stress on the coil.

Typical Operating Characteristics

Magnetic Operating Switch Points

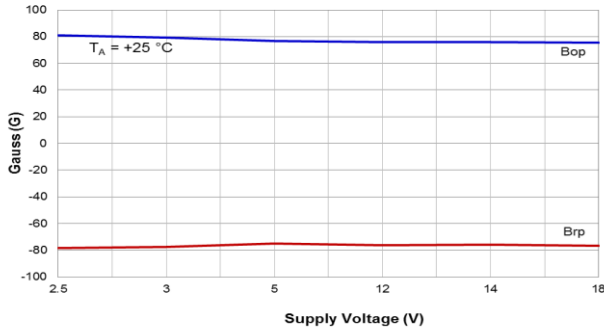

Magnetic Switch Points Bop & Brp vs. Supply Voltage

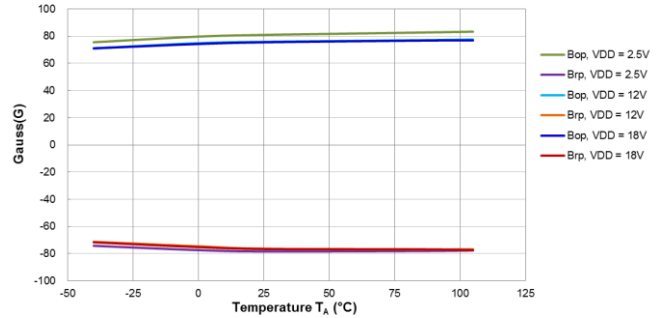

Magnetic Switch Points Bop & Brp vs. Temperature

Average Supply Current

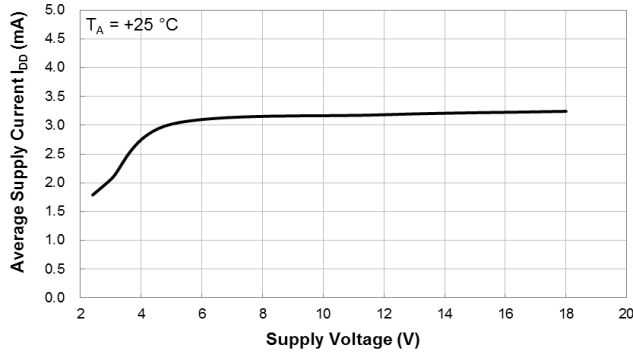

Average Supply Current vs. Supply Voltage

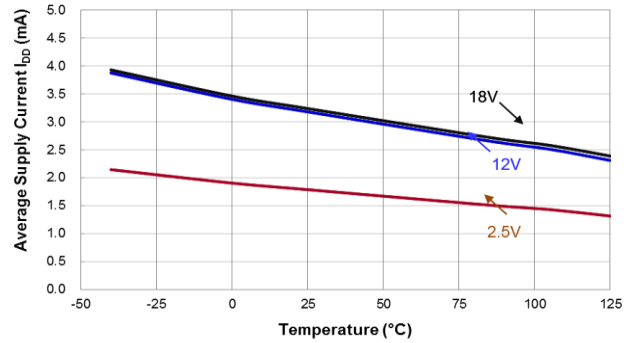

Average Supply Current vs. Temperature

Lock Detect Ton and Shutdown Toff Periods

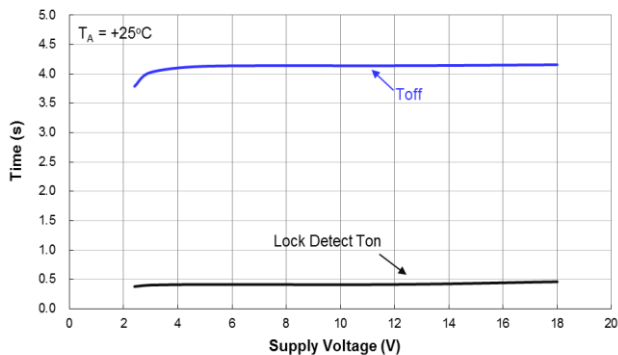

Lock Detect Ton and Toff vs. Supply Voltage

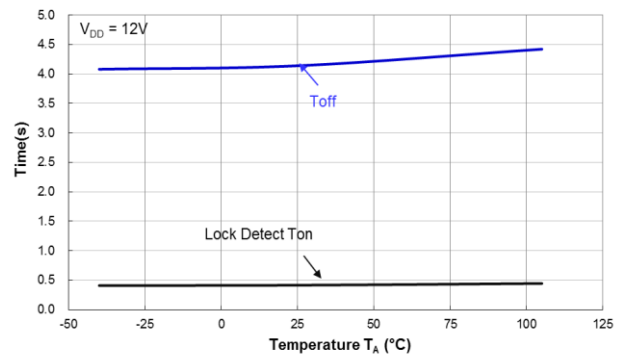

Lock Detect Ton and Toff vs. Supply Voltage

Typical Operating Characteristics (continued)

Total H-Bridge Path Resistance – Total $R_{DS(ON)}$ of High Side and Low Side Switches

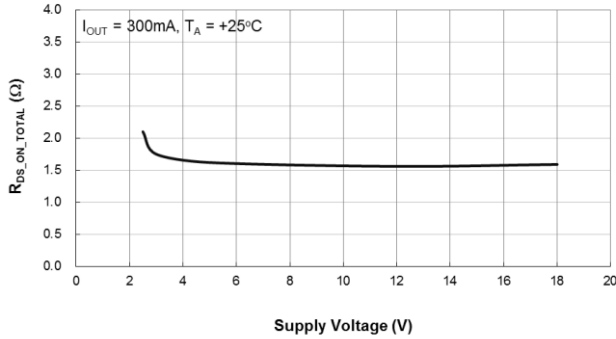

High+Low Side Resistance $R_{DS_ON_TOTAL}$ vs. Supply Voltage

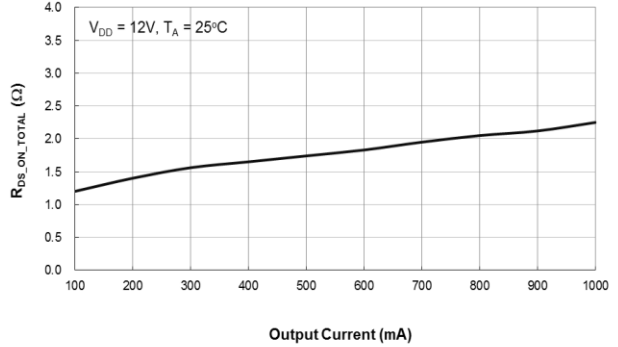

High+Low Side Resistance $R_{DS_ON_TOTAL}$ vs. Current

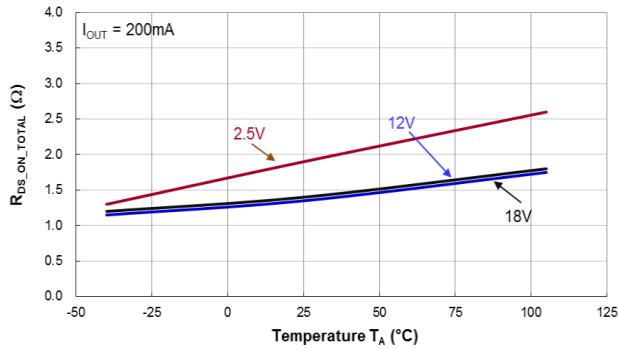

High+Low Side Resistance $R_{DS_ON_TOTAL}$ vs. Temperature

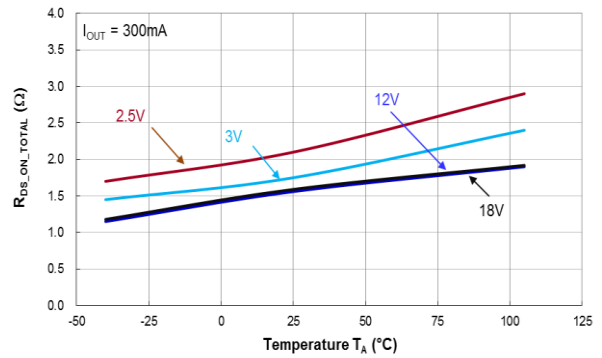

High+Low Side Resistance $R_{DS_ON_TOTAL}$ vs. Temperature

Thermal Performance

TO94 Power Dissipation Derating Curve (Note 14)

T _A (°C)	-40	0	25	50	60	70	80	85	90	95	100	105	110	120	125	130	140	150
P _D (mW)	1500	1500	1500	1200	1080	960	840	780	720	660	600	540	480	360	300	240	120	0

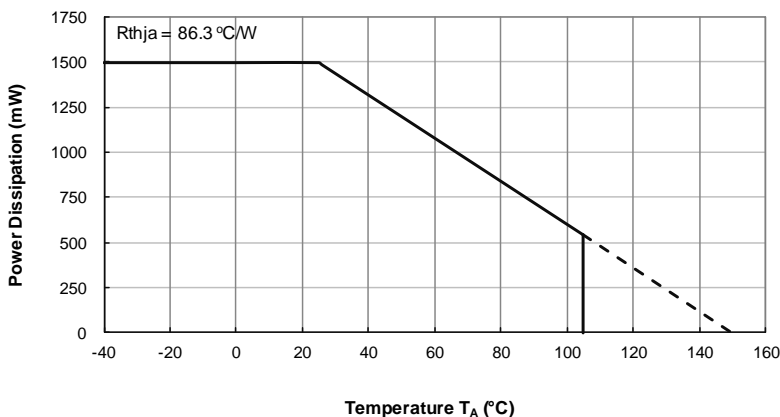

TO94 Thermal Derating Curve

Note 14: TO94 through-hole mounted to minimum recommended landing pads (through holes) on a 2" x 2" two-layer 2oz. copper FR4 PCB (1.6mm thickness) with copper flood on the top but without copper flood on the bottom layer.

TO94 Power Dissipation Derating Curve for Circuit PCB with Center Hole Cut-Out (Note 15)

T _A (°C)	-40	0	25	50	60	70	80	85	90	95	100	105	110	120	125	130	140	150
P _D (mW)	827	827	827	662	595	529	463	430	397	364	331	298	298	265	198	165	132	0

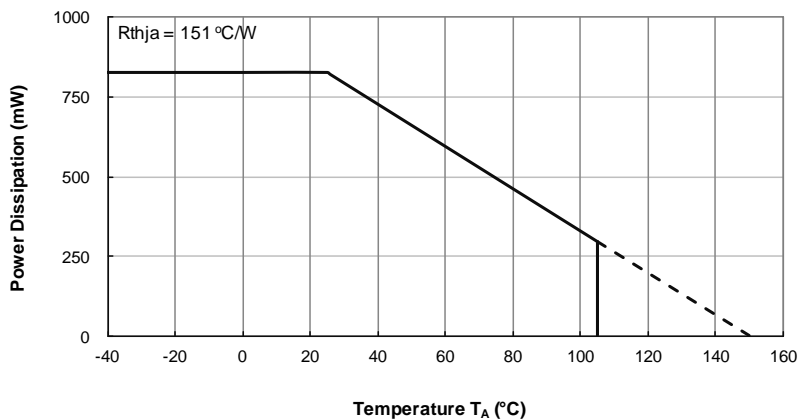

TO94 Thermal Derating Curve
(Custom Circular PCB with Centre Hole Cut-Out)

Note: 15. TO94 through-hole mounted in a circular PCB with center hole cutout, single-layer 2oz. copper FR4 PCB (1.6mm thickness) with partial copper flood on the bottom layer. The circuit PCB diameter is 1.2" with the center circular cutout diameter of 0.53", The TO94 space cut-out is 0.2" x 0.135". See below for details.

Thermal Performance (continued)

Circular PCB Dimensions

The circular PCB diameter is 1.2" with the centre circular cutout diameter of 0.53". The TO94 space cut-out is 0.2" x 0.135", single-layer 2oz.copper FR4 PCB (1.6mm thickness) with partial copper flood on the bottom layer.

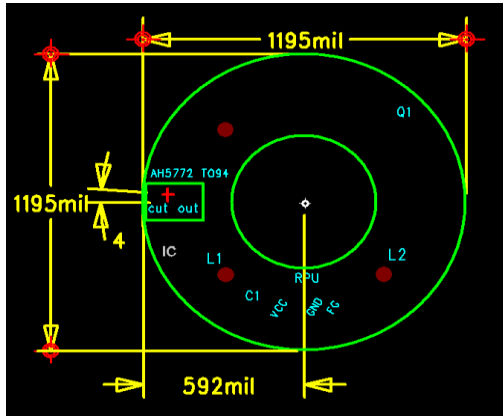

Custom Circular PCB – Top View

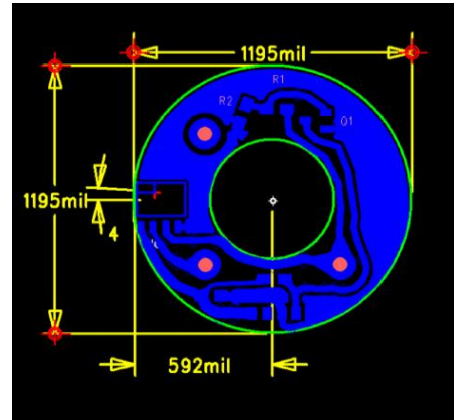

Custom Circular PCB – Bottom View

Ordering Information

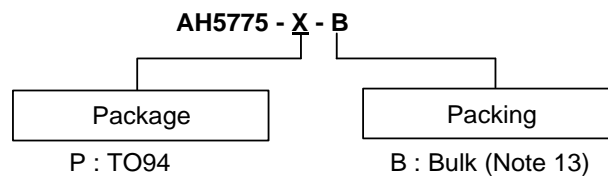

Part Number	Package Code	Packaging	Bulk	
			Quantity	Part Number Suffix
AH5775-P-B	P	TO94	1,000	-B

Marking Information

(1) Package Type: TO94

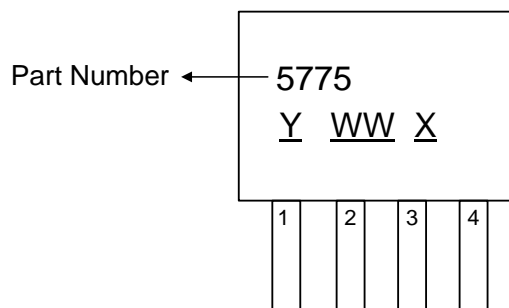

Y : Year : 0~9
 WW : Week : 01 ~ 52;
 52 represents 52 and 53 week
 X : Internal code

Package Outline Dimensions (All dimensions in mm.)

Please see AP02002 at <http://www.diodes.com/datasheets/ap02002.pdf> for the latest version.

(1) Package Type: T094

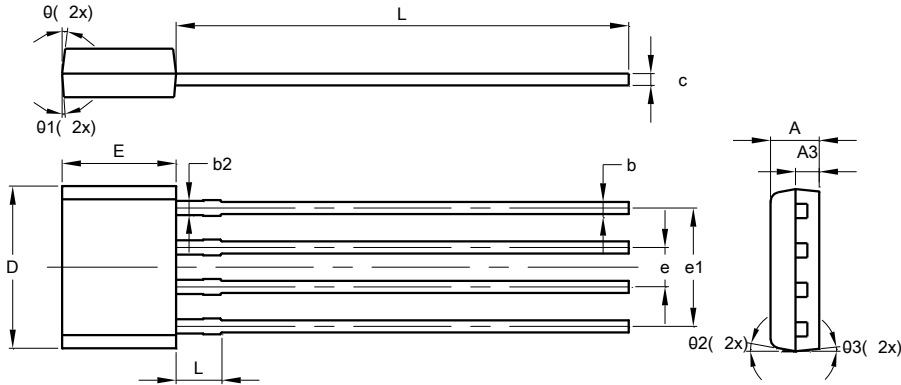

T094			
Dim	Min	Max	Typ
A	1.46	1.66	1.56
A3	-	-	0.76
b	0.35	0.56	0.39
b2	-	-	0.46
c	0.36	0.51	0.38
D	5.12	5.32	5.22
E	3.55	3.75	3.65
e	-	-	1.27
e1	-	-	3.81
L	13.50	15.50	14.50
L1	-	-	1.42
S	0.63	0.83	0.73
theta	-	-	6°
theta1	-	-	4°
theta2	-	-	11°
theta3	-	-	6°
All Dimensions in mm			

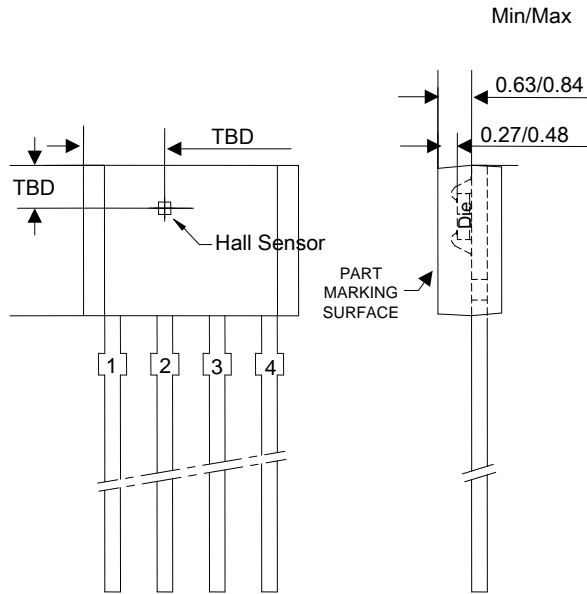

Sensor Location

IMPORTANT NOTICE

DIODES INCORPORATED MAKES NO WARRANTY OF ANY KIND, EXPRESS OR IMPLIED, WITH REGARDS TO THIS DOCUMENT, INCLUDING, BUT NOT LIMITED TO, THE IMPLIED WARRANTIES OF MERCHANTABILITY AND FITNESS FOR A PARTICULAR PURPOSE (AND THEIR EQUIVALENTS UNDER THE LAWS OF ANY JURISDICTION).

Diodes Incorporated and its subsidiaries reserve the right to make modifications, enhancements, improvements, corrections or other changes without further notice to this document and any product described herein. Diodes Incorporated does not assume any liability arising out of the application or use of this document or any product described herein; neither does Diodes Incorporated convey any license under its patent or trademark rights, nor the rights of others. Any Customer or user of this document or products described herein in such applications shall assume all risks of such use and will agree to hold Diodes Incorporated and all the companies whose products are represented on Diodes Incorporated website, harmless against all damages.

Diodes Incorporated does not warrant or accept any liability whatsoever in respect of any products purchased through unauthorized sales channel. Should Customers purchase or use Diodes Incorporated products for any unintended or unauthorized application, Customers shall indemnify and hold Diodes Incorporated and its representatives harmless against all claims, damages, expenses, and attorney fees arising out of, directly or indirectly, any claim of personal injury or death associated with such unintended or unauthorized application.

Products described herein may be covered by one or more United States, international or foreign patents pending. Product names and markings noted herein may also be covered by one or more United States, international or foreign trademarks.

This document is written in English but may be translated into multiple languages for reference. Only the English version of this document is the final and determinative format released by Diodes Incorporated.

LIFE SUPPORT

Diodes Incorporated products are specifically not authorized for use as critical components in life support devices or systems without the express written approval of the Chief Executive Officer of Diodes Incorporated. As used herein:

A. Life support devices or systems are devices or systems which:

1. are intended to implant into the body, or
2. support or sustain life and whose failure to perform when properly used in accordance with instructions for use provided in the labeling can be reasonably expected to result in significant injury to the user.

B. A critical component is any component in a life support device or system whose failure to perform can be reasonably expected to cause the failure of the life support device or to affect its safety or effectiveness.

Customers represent that they have all necessary expertise in the safety and regulatory ramifications of their life support devices or systems, and acknowledge and agree that they are solely responsible for all legal, regulatory and safety-related requirements concerning their products and any use of Diodes Incorporated products in such safety-critical, life support devices or systems, notwithstanding any devices- or systems-related information or support that may be provided by Diodes Incorporated. Further, Customers must fully indemnify Diodes Incorporated and its representatives against any damages arising out of the use of Diodes Incorporated products in such safety-critical, life support devices or systems.

Copyright © 2015, Diodes Incorporated

www.diodes.com