

## Description

The AH8501 is a high accuracy, low power/micropower linear Hall effect sensor with an 8-bit output resolution. The output voltage is ratiometric to the supply voltage and proportional to the magnetic flux density, perpendicular to the part marking surface. The output null voltage is at half the supply voltage.

AH8501 is a trimmed device with typical sensitivity of 2.25mV/G and 3.8mV/G at 1.8V and 3V respectively with an accuracy of 3% at 25°C. The device has a typical input referred rms noise of 0.36G and 0.24G at 1.8V and 3.0V.

Designed for battery powered consumer equipment to office equipment, home appliances and industrial applications, the AH8501 can operate over the supply range of 1.6V to 3.6V and uses an externally controlled ENABLE pin clocking system to control operating modes and sampling rates to minimize the power consumption. The typical average operating supply current is between 8.9µA during sleep mode and 1.16mA at maximum sampling rate at 1.8V. With a conversion pulse every 50ms at the ENABLE pin, the device achieves a micropower operation with the power consumption of 22µW typical at 1.8V supply.

To minimize PCB space the AH8501 are available in small, low profile U-DFN2020-6.

## Features

- High Accuracy Linear Hall Effect Sensor with +/-400G Sense Range and Output Voltage with 8-bit resolution
- Supply Voltage of 1.6V to 3.6V
- High Accuracy: Trimmed Sensitivity of 2.25mV/G and 3.8mV/G at 1.8V and 3V Respectively with Accuracy of 3% at +25°C
- Low Offset Voltage
- Low Average Supply Current
  - 8.9µA Typical in Sleep Mode (Default) at 1.8V
  - 1.01mA Typical in Auto-Run Mode (6.25kHz) at 1.8V
  - 12µA Typical in External Drive Mode with 20Hz Sample Rate at 1.8V
  - 1.16mA Typical in External Drive Mode with 7.14kHz Sample Rate at 1.8V
- Chopper Stabilized Design with Superior Temperature Stability, Minimal Sensitivity Drift, Enhanced Immunity to Physical Stress
- Output Voltage Maintained at 'Sleep' Mode
- -40°C to +85°C Operating Temperature
- High ESD Capability of 6kV Human Body Model
- Small Low Profile U-DFN2020-6 Package
- **Totally Lead-Free & Fully RoHS Compliant (Notes 1 & 2)**
- **Halogen and Antimony Free. "Green" Device (Note 3)**

Notes: 1. No purposely added lead. Fully EU Directive 2002/95/EC (RoHS) & 2011/65/EU (RoHS 2) compliant.  
 2. See [http://www.diodes.com/quality/lead\\_free.html](http://www.diodes.com/quality/lead_free.html) for more information about Diodes Incorporated's definitions of Halogen- and Antimony-free, "Green" and Lead-free.  
 3. Halogen- and Antimony-free "Green" products are defined as those which contain <900ppm bromine, <900ppm chlorine (<1500ppm total Br + Cl) and <1000ppm antimony compounds.

## Pin Assignments

(Top View)

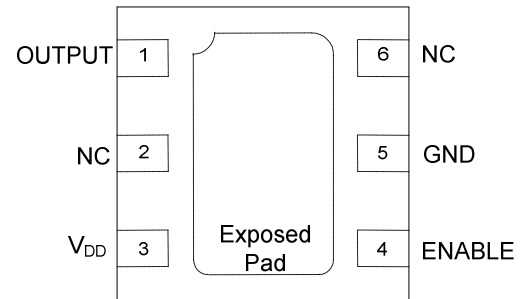

**U-DFN2020-6**

## Applications

- High Accuracy Level, Proximity, Position and Travel Detection
- Button Press Detection in Digital Still, Video Cameras and Handheld Gaming Consoles
- Accurate Door, Lids and Tray Position Detection
- Liquid Level Detection
- Joy Stick Control – Gaming and Industrial Applications
- Contact-Less Level, Proximity and Position Measurement in Home Appliances and Industrial Applications

**Typical Applications Circuit**

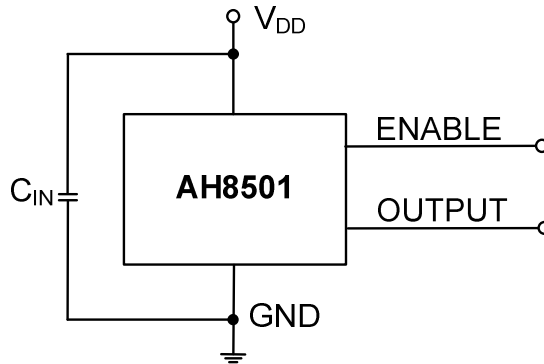

Note: 4.  $C_{IN}$  is for power stabilization and to strengthen the noise immunity, the recommended capacitance is 100nF typical and should be placed as close to the supply pin as possible.

**Pin Descriptions**

Package: U-DFN2020-6

Pin Number	Pin Name	Function
1	OUTPUT	Output Pin
2	NC	No Connection (Note 5)
3	$V_{DD}$	Power Supply Input
4	ENABLE	<p>Device "Awake" and "Sleep" control pin: An external PWM signal to the ENABLE pin controls the operating modes (Sleep Mode, Auto-Run Mode and External Drive Mode), awake and sleep periods to adjust the sampling rate and to minimize the power consumption to achieve micropower operation.</p> <p>When the ENABLE = GND continuously the device is in sleep mode consuming only 8.9<math>\mu</math>A typical at 1.8V. When the ENABLE pin is left floating, the device defaults to sleep mode. The ENABLE pin is internally pulled low.</p> <p>When ENABLE = <math>V_{DD}</math> (or Logic High) continuously, device is in auto-run mode with sampling rate of 6.25kHz typical consuming 1.01mA at 1.8V</p> <p>In external drive mode, an external PWM signal can be used to drive the ENABLE pin to adjust the sampling frequency up to 7.14kHz typical.</p> <p>A minimum pulse width needed on ENABLE pin to start one Awake/Sleep cycle (i.e. one sample/conversion cycle) is 20<math>\mu</math>s typical. We recommended using a pulse width of 40<math>\mu</math>s minimum. The minimum awake period for one sample/conversion cycle is 140<math>\mu</math>s typical.</p>
5	GND	Ground Pin
6	NC	No Connection (Note 5)
Pad	Pad	<p>The center exposed pad – No connection internally. The exposed pad can be left open (unconnected) or tied to the GND on the PCB layout.</p>

Note: 5. NC is "No Connection" pin and is not connected internally. This pin can be left open or tied to ground.

## Functional Block Diagram

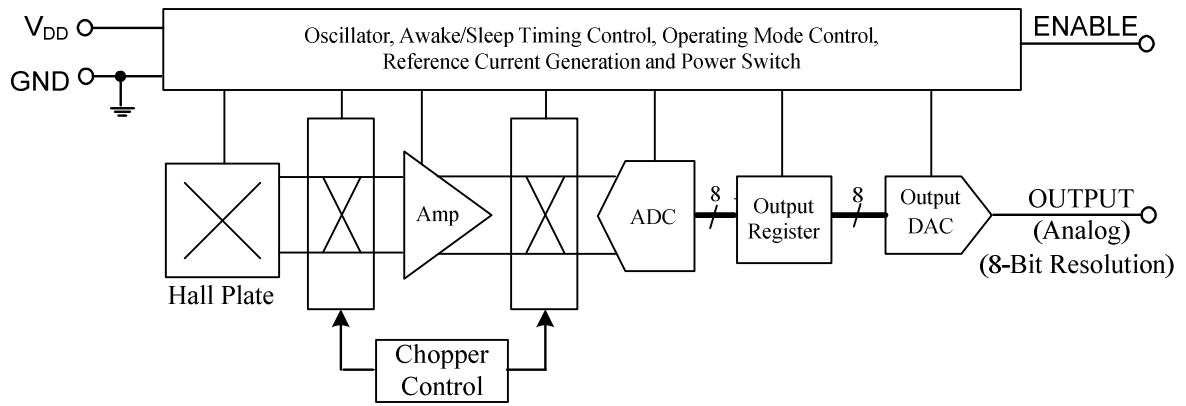

**Absolute Maximum Ratings** (Note 6) (@ $T_A = +25^\circ\text{C}$ , unless otherwise specified.)

Symbol	Parameter	Rating	Unit
$V_{DD}$ and $V_{OUT}$	Supply Voltage and Output Voltage (Note 7)	4	V
$V_{DD\_REV}$ and $V_{OUT\_REV}$	Reverse Supply and Output Voltage	-0.3	V
$I_{OUT}$	Output Current (limited by 10kOhms output resistor)	$V_{DD}/10$	mA
B	Magnetic Flux Density Withstand	Unlimited	
$P_D$	Package Power Dissipation	U-DFN2020-6	230 mW
$T_s$	Storage Temperature Range	-65 to +150	$^\circ\text{C}$
$T_J$	Maximum Junction Temperature	150	$^\circ\text{C}$
ESD HBM	Human Body Model (HMB) ESD Capability	6	kV

- Notes:
- Stresses greater than the 'Absolute Maximum Ratings' specified above may cause permanent damage to the device. These are stress ratings only; functional operation of the device at these or any other conditions exceeding those indicated in this specification is not implied. Device reliability may be affected by exposure to absolute maximum rating conditions for extended periods of time.
  - The absolute maximum  $V_{DD}$  of 4V is a transient stress rating and is not meant as a functional operating condition. It is not recommended to operate the device at the absolute maximum rated conditions for any period of time.

**Recommended Operating Conditions** (@ $T_A = +25^\circ\text{C}$ , unless otherwise specified.)

Symbol	Parameter	Conditions	Rating	Unit
$V_{DD}$	Supply Voltage	Operating	1.6V to 3.6V	V
$T_A$	Operating Temperature Range	Operating	-40 to +85	$^\circ\text{C}$

**Electrical Characteristics** (Notes 8 & 9) (@ $T_A = +25^\circ\text{C}$ ,  $V_{DD} = 1.8\text{V}$ , unless otherwise specified.)

Symbol	Parameter	Conditions	Min	Typ	Max	Unit
<b>Supply Current</b>						
$I_{DD\_AWAKE}$	Supply Current in Awake Period (During "Awake" Period)	$V_{OUTPUT} = V_{DD}/2$ , ENABLE = $V_{DD}$ , $V_{DD} = 1.8\text{V}$ (Note 10)	-	1.35	1.7	mA
		$V_{OUTPUT} = V_{DD}/2$ , ENABLE = $V_{DD}$ , $V_{DD} = 3\text{V}$ (Note 10)	-	1.92	2.4	
$I_{DD\_SLEEP}$	Supply Current in Sleep Mode (During 'Sleep' Period)	$V_{OUTPUT} = V_{DD}/2$ , ENABLE = GND, $V_{DD} = 1.8\text{V}$	-	8.93	15	$\mu\text{A}$
		$V_{OUTPUT} = V_{DD}/2$ , ENABLE = GND, $V_{DD} = 3\text{V}$	-	11.1	18	
$I_{DD\_20\text{Hz}}$	Average Supply Current at 20Hz Sample Rate	$V_{OUTPUT} = V_{DD}/2$ , ENABLE clocking at 20Hz frequency, $V_{DD} = 1.8\text{V}$ (Note 10)	-	12.1	20	$\mu\text{A}$
		$V_{OUTPUT} = V_{DD}/2$ , ENABLE clocking at 20Hz frequency, $V_{DD} = 3\text{V}$ (Note 10)	-	15.7	25	$\mu\text{A}$
$I_{DD\_7\text{kHz}}$	Average Supply Current at 7.14kHz Sample Rate	$V_{OUTPUT} = V_{DD}/2$ , ENABLE clocking at 7.14kHz, $V_{DD} = 1.8\text{V}$ (Note 10)	-	1.16	1.5	mA
		$V_{OUTPUT} = V_{DD}/2$ , ENABLE clocking at 7.14kHz, $V_{DD} = 3\text{V}$ (Note 10)	-	1.65	2.1	mA
$I_{DD\_AUTORUN}$	Average Supply Current in Auto-Run Mode when ENABLE = Logic High (or $V_{DD}$ ) Continuously (The sampling frequency when ENABLE = High continuously is 6.25kHz)	$V_{OUTPUT} = V_{DD}/2$ , ENABLE = $V_{DD}$ , $V_{DD} = 1.8\text{V}$ (Note 10)	-	1.01	1.3	mA
		$V_{OUTPUT} = V_{DD}/2$ , ENABLE = $V_{DD}$ , $V_{DD} = 3\text{V}$ (Note 10)	-	1.44	1.8	mA

- Notes:
- When power is initially turned on, the operating  $V_{DD}$  (1.6V to 3.6V) must be applied to guarantee the output sampling. After the supply voltage reaches minimum operating voltage, the output state is valid after 140us after the ENABLE pin pulled or clocked high.
  - Typical data is at  $T_A = +25^\circ\text{C}$ ,  $V_{DD} = 1.8\text{V}$  unless otherwise stated.
  - The parameters are not tested in production, they are guaranteed by design, characterization and process control.

**Electrical Characteristics (cont)** (@T<sub>A</sub> = +25°C, V<sub>DD</sub> = 1.8V, unless otherwise specified.)

**ENABLE Pin Timing, Conversion Rate and I<sub>DD</sub> Supply Current Relationship**

**AH8501 ENABLE Pin Clocked**

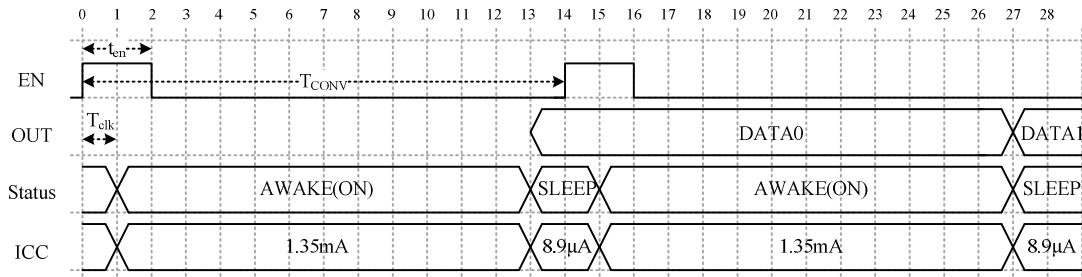

Status: **AWAKE**: chip processing phase (12\*T<sub>clk</sub>),      **SLEEP**: chip retain data

T<sub>clk</sub>: internal clock period, typical = 10µs  
 ten: pulse width of enable signal, minimum=2\*T<sub>clk</sub>= 20µs (typical)  
 T<sub>CONV</sub>: One sample/conversion cycle = 14\*T<sub>clk</sub>= 140µs (typical)

I<sub>DD</sub>( @ V<sub>DD</sub> = 1.8V, 25°C):  
 (1) If ENABLE pin clocked at maximum (~7.14 kHz): I<sub>DD</sub> = 1.35mA\*12/14+8.93µA\*2/14 ≈ 1.16mA  
 (2) If ENABLE pin clocked at 20Hz: I<sub>DD</sub> ≈ 12µA  
 (3) If ENABLE clocking period=T, I<sub>DD</sub> = 1.35mA\*120µs/T + 8.93µA\*(T-120µs)/T

**AH8501 ENABLE = Logic High (V<sub>DD</sub>) Continuously – Auto-Run Mode**

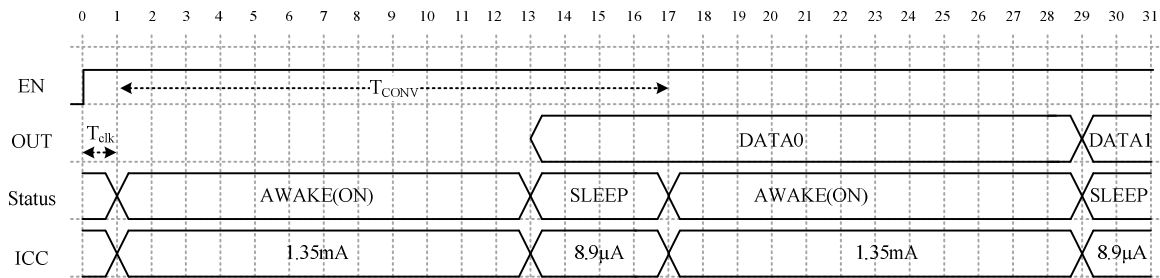

T<sub>clk</sub>: internal clock period, typical= 10µs  
 T<sub>CONV</sub>: One sample/conversion period when ENABLE = High (V<sub>DD</sub>) = 16\*T<sub>clk</sub>=160 µs

I<sub>DD</sub>( @ V<sub>DD</sub> = 1.8V, 25°C):  
 I<sub>DD</sub> = 1.35mA\*120µs/160µs + 8.93µA\*40µs/160µs ≈ 1.01mA (typical)

**Electrical Characteristics** (cont.) (Notes 11, 12 & 13) (@ $T_A = +25^\circ\text{C}$ ,  $V_{DD} = 1.8\text{V}$ , unless otherwise specified.)

Symbol	Parameter	Conditions	Min	Typ	Max	Unit
$t_{ON\_INITIAL}$	Initial Power On Time	$V_{DD} = 1.8\text{V}$ , $T_A = +25^\circ\text{C}$ , $C_{IN}=0.1\mu\text{F}$ , $V_{DD}$ rise time =10us, (Note 14)	-	1	-	ms
		$V_{DD} = 3\text{V}$ , $T_A = +25^\circ\text{C}$ , $C_{IN}=0.1\mu\text{F}$ , $V_{DD}$ rise time =10us, (Note 14)	-	0.2	-	ms
$t_{en}$	Minimum Pulse Width on ENABLE Pin To Start One Conversion Cycle When Driving ENABLE pin Externally (See application note section)	$V_{DD} = 1.6\text{V}$ to $3.6\text{V}$ , $T_A = -40^\circ\text{C}$ to $+85^\circ\text{C}$ (Note 14)	-	20	-	$\mu\text{s}$
$T_{CONV}$	Minimum Period of One Sample/Conversion Cycle	$V_{DD} = 1.6\text{V}$ to $3.6\text{V}$ , $T_A = -40^\circ\text{C}$ to $+85^\circ\text{C}$ (Note 14)	100	140	200	$\mu\text{s}$
$f_{MAX}$	Maximum Sampling Frequency	$V_{DD} = 1.6\text{V}$ to $3.6\text{V}$ , $T_A = -40^\circ\text{C}$ to $+85^\circ\text{C}$ , (Note 14)	-	7.14	-	kHz
$f_{EN\_HIGH}$	Sampling Frequency when ENABLE = Logic High (or $V_{DD}$ ) continuously.	ENABLE = High ( $V_{DD}$ ), $V_{DD} = 1.6\text{V}$ to $3.6\text{V}$ , $T_A = -40^\circ\text{C}$ to $+85^\circ\text{C}$ (Note 14)	-	6.25	-	kHz
$V_{EN\_LOW}$	Enable pin input low voltage	$V_{DD} = 1.8\text{V}$ (Note 13)	0.4	0.5	0.6	V
		$V_{DD} = 3.0\text{V}$ (Note 13)	0.8	0.9	1	V
$V_{EN\_HIGH}$	Enable pin input high voltage	$V_{DD} = 1.8\text{V}$ (Note 13)	1.2	1.3	1.4	V
		$V_{DD} = 3\text{V}$ (Note 13)	2.2	2.3	2.4	V
<b>Output Characteristics</b>						
$R_{OUT}$	DC Output Resistance	ENABLE = $V_{DD}$ or GND, $V_{DD} = 1.6\text{V}$ to $3.6\text{V}$ , $T_A = -40^\circ\text{C}$ to $+85^\circ\text{C}$ , (Note 14)	-	10	13	$\text{k}\Omega$
Noise_RMS	Input Referred Noise, RMS (Note 14)	$C_{IN} = \text{Open}$ , $V_{DD} = 1.8\text{V}$ , $T_A = +25^\circ\text{C}$ ,	-	0.36	-	G
		$C_{IN} = \text{Open}$ , $V_{DD} = 3.0\text{V}$ , $T_A = +25^\circ\text{C}$ ,	-	0.24	-	G
ADCRES DACRES	Internal ADC and DAC resolution	(Note 14)	-	8	-	Bit
$V_{OUT\_RES}$	Output Voltage Resolution	$V_{DD} = 1.6\text{V}$ to $3.6\text{V}$ , $T_A = -40^\circ\text{C}$ to $+85^\circ\text{C}$	-	$V_{DD}/256$	-	mV
$V_{OUTH}$	Max. Output Voltage	$V_{DD} = 1.6\text{V}$ to $3.6\text{V}$ , $T_A = -40^\circ\text{C}$ to $+85^\circ\text{C}$	-	$V_{DD} \cdot 255/256$	-	V
$V_{OUTL}$	Min. Output Voltage	$V_{DD} = 1.6\text{V}$ to $3.6\text{V}$ , $T_A = -40^\circ\text{C}$ to $+85^\circ\text{C}$	-	0	-	V

- Notes:
- When power is initially turned on, the operating  $V_{DD}$  (1.6V to 3.6V) must be applied to guarantee the output sampling. The output state is valid after  $t_{ON\_INITIAL}$  from the supply voltage reaching the minimum operating voltage.
  - Typical data is at  $T_A = +25^\circ\text{C}$ ,  $V_{DD} = 1.8\text{V}$  unless otherwise stated.
  - Maximum and minimum parameters values over operating temperature range are not tested in production, they are guaranteed by design, characterization and process control.
  - The parameter is not tested in production, they are guaranteed by design, characterization and process control.

### Electrical Characteristics (cont.) (Notes 11, 12 & 13) (@ $T_A = +25^\circ\text{C}$ , $V_{DD} = 1.8\text{V}$ , unless otherwise specified.)

Symbol	Parameter	Conditions	Min	Typ	Max	Unit
<b>Magnetic Characteristics</b>						
B <sub>RANGE</sub>	Measurable Magnetic Flux Density Range	$V_{DD} = 1.8\text{V}$ , $T_A = +25^\circ\text{C}$	±388	±400	±412	G
		$V_{DD} = 3\text{V}$ , $T_A = +25^\circ\text{C}$	±382	±395	±408	G
G <sub>RES</sub>	Gauss Resolution	$V_{DD} = 1.8\text{V}$ , $T_A = +25^\circ\text{C}$	3.033	3.125	3.221	G/LSB
		$V_{DD} = 3\text{V}$ , $T_A = +25^\circ\text{C}$	2.994	3.084	3.179	G/LSB
V <sub>NULL</sub>	Quiescent Output Voltage with zero gauss	$B = 0.5\text{G}$ , $T_A = +25^\circ\text{C}$	-	$V_{DD}/2$	-	V
		$V_{DD} = 1.8\text{V}$ , $T_A = +25^\circ\text{C}$	0.882	0.9	0.918	V
		$V_{DD} = 3\text{V}$ , $T_A = +25^\circ\text{C}$	1.47	1.5	1.53	V
V <sub>OFFSET</sub>	Quiescent Output Voltage Offset	$B = 0.5\text{G}$ , $V_{DD} = 1.8\text{V}$ , $T_A = +25^\circ\text{C}$	-1%	-	1%	% of $V_{DD}$
		$B = 0.5\text{G}$ , $V_{DD} = 3\text{V}$ , $T_A = +25^\circ\text{C}$	-1%	-	1%	% of $V_{DD}$
		$B = 0.5\text{G}$ , $V_{DD} = 1.6\text{V}$ to $3.6\text{V}$ , $T_A = -40^\circ\text{C}$ to $+85^\circ\text{C}$ (Note 14)	-1.5	-	1.5	% of $V_{DD}$
V <sub>SENS</sub>	Output Voltage Sensitivity	$V_{DD} = 1.8\text{V}$ , $T_A = +25^\circ\text{C}$	2.183	2.25	2.318	mV/G
		$V_{DD} = 3\text{V}$ , $T_A = +25^\circ\text{C}$	3.686	3.80	3.914	
V <sub>SENS_ACC</sub>	Sensitivity Accuracy	$V_{DD} = 1.8\text{V}$ , $T_A = +25^\circ\text{C}$	-3	-	3	%
		$V_{DD} = 3\text{V}$ , $T_A = +25^\circ\text{C}$	-3	-	3	%
		$V_{DD} = \text{fixed at any one voltage between } 1.6\text{V to } 3.6\text{V}$ , $T_A = -40^\circ\text{C}$ to $+85^\circ\text{C}$ (Note 14, Note 15)	-6	-	6	%
TC_ERR <sub>SENS</sub>	Sensitivity error over full temperature	$V_{DD} = \text{fixed}$ , $T_A = -40^\circ\text{C}$ to $+85^\circ\text{C}$ , (Note 14)	-3	-	3	%
Lin+	Positive linearity (span linearity)	$V_{DD} = 1.8\text{V}$ , $T_A = +25^\circ\text{C}$ (Note 14)	-	99.9	-	%
		$V_{DD} = 3.0\text{V}$ , $T_A = +25^\circ\text{C}$ (Note 14)	-	99.7	-	%
Lin-	Negative linearity (span linearity)	$V_{DD} = 1.8\text{V}$ , $T_A = +25^\circ\text{C}$ (Note 14)	-	100.1	-	%
		$V_{DD} = 3.0\text{V}$ , $T_A = +25^\circ\text{C}$ (Note 14)	-	100.4	-	%

- Notes:
- When power is initially turned on, the operating  $V_{DD}$  (1.6V to 3.6V) must be applied to guarantee the output sampling. The output state is valid after  $t_{ON\_INITIAL}$  from supply voltage reaching the minimum operating voltage.
  - Typical data is at  $T_A = +25^\circ\text{C}$ ,  $V_{DD} = 1.8\text{V}$  unless otherwise stated.
  - Maximum and minimum parameters values over operating temperature range are not tested in production, they are guaranteed by design, characterization and process control.
  - The parameter is not tested in production, they are guaranteed by design, characterization and process control.
  - This term constitutes of output voltage sensitivity temperature coefficient error and sensitivity trim accuracy.

## Application Note

### ENABLE Pin - Awake and Sleep Period Control

ENABLE pin controls the device's "Awake" and "Sleep" periods and operating modes (Sleep, Auto-Run and External Drive modes).

When the ENABLE pin is pulled low (ENABLE = GND) continuously, the device enters sleep mode where the supply current is 8.93µA typical at V<sub>DD</sub> = 1.8V (the output is 0.9V). The ENABLE pin is internally pulled low and therefore the default mode is the sleep mode if the ENABLE pin is left floating.

When the ENABLE pin is pulled high (ENABLE = V<sub>DD</sub> or pulled high) the device enters auto-run mode with the conversion time T<sub>CONV</sub> of 16 clock cycles (160µs typical) and therefore the sampling rate is 6.25kHz. The average supply current with the ENABLE pin pulled high continuously is 1.01mA at V<sub>DD</sub> = 1.8V.

In external drive mode, the sample rate can be controlled between 0 to 7.14kHz by clocking the ENABLE pin with an external PWM signal. The minimum pulse width needed on the ENABLE pin to start sample/conversion is 20µs typical; we recommend using pulse width of 40µs minimum.

When the ENABLE pin is clocked, the conversion time (signal acquisition, conversion and output update) T<sub>CONV</sub> is 14 clock cycles (140µs typical). When the ENABLE goes high, the sample trigger delay is 1 clock pulse (10µs) where supply current remains at 8.93µA typical at V<sub>DD</sub> = 1.8V. After the sample trigger delay, the next 12 clock pulse (120µs typical) is 'Awake' period where the typical supply current is 1.35mA at 1.8V supply. The next pulse (10µs) is used to update the output stage and during this time the supply current drops back to 8.93µA typical at 1.8V supply. Therefore, the average supply current while the device is at the maximum sampling rate of 7.14kHz is 1.16mA typical at 1.8V supply. At a sampling rate of 20Hz, the supply current is 12µA typical at V<sub>DD</sub> = 1.8V achieving micropower operation.

For ENABLE pin clocking period of T, the average current is given by

$$I_{DD} = \frac{1.35mA \times 120\mu s + 8.93\mu A \times (T - 120\mu s)}{T} \quad (@ 1.8V)$$

$$I_{DD} = \frac{I_{DD\_AWAKE} \times 120\mu s + I_{DD\_SLEEP} \times (T - 120\mu s)}{T} \quad (\text{General equation})$$

### Quiescent Output Voltage V<sub>NULL</sub> and Offset Voltage

The figure below shows the ideal transfer curve near zero magnetic field (B = 0Gauss). Zero Gauss is the transition point between V<sub>OUTPUT</sub> = V<sub>DD</sub>\*127/128 and V<sub>OUTPUT</sub> = V<sub>DD</sub>/2. When B is slightly larger than zero, the output is one-half the supply voltage typically.

Quiescent output voltage (V<sub>NULL</sub>) is defined as the typical output voltage when B = 0.5Gauss (slightly higher than 0G). Any difference of V<sub>NULL</sub> from V<sub>DD</sub>/2 introduces offset (V<sub>OFFSET</sub>).

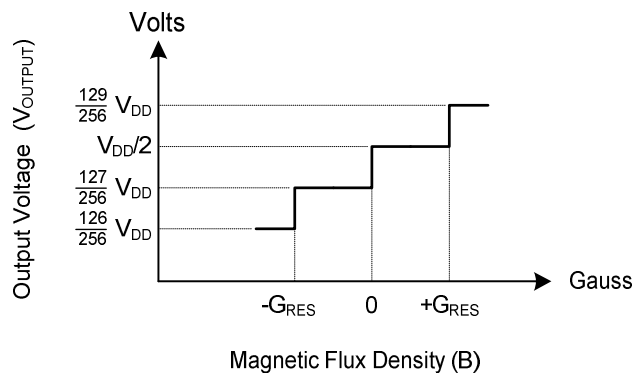

Transfer Curve Near 0 Gauss



**Application Note** (continued)

**Sensitivity and Transfer Characteristic**

The device responds to the magnetic flux density perpendicular to the part marking surface. For South pole magnetic flux density increase from 0G, the output voltage will increase from  $V_{NULL}$  and for a North magnetic pole field, the output will decrease from  $V_{NULL}$ . The changes in the voltage level up or down are symmetrical to  $V_{NULL}$  and are proportional to the magnetic flux density.

The output voltage change is proportional to the magnitude and polarity of the magnetic field perpendicular to the part marking surface. This proportionality is defined as output voltage sensitivity and is given by

$$V_{SENS} = \frac{(V_{OUT(B,MAX)} - V_{OUT(B,MIN)})}{(B_{MAX} - B_{MIN})}$$

The AH8501 has a measurable magnetic field range of +/-400G and output voltage range of 0V to (255/256) $V_{DD}$ . Therefore sensitivity at 1.8V is given by

$$V_{SENS_{1.8V}} = \frac{1.8V}{800G} = 2.25mV/G$$

The device has an internal ADC and DAC with a resolution of 8-bits. Therefore, the measurement resolution is 3.125G/LSB at  $V_{DD} = 1.8V$ . In terms of voltage, the output resolution at 1.8V is 7mV/LSB typical. The device follows the 8-bit step for transfer curve superimposed on the  $V_{SENS}$  above. This difference in theoretical linear value with 8-bit resolution steps produces a measurement (quantization) error at each step.

$$\begin{aligned} \text{Quantization error (also measurement error)} &= 0.5 * \text{step} = V_{DD}/512(\text{output voltage}), \text{ OR} \\ &= \text{Full magnetic range}/512 (\text{input magnetic field}) \end{aligned}$$

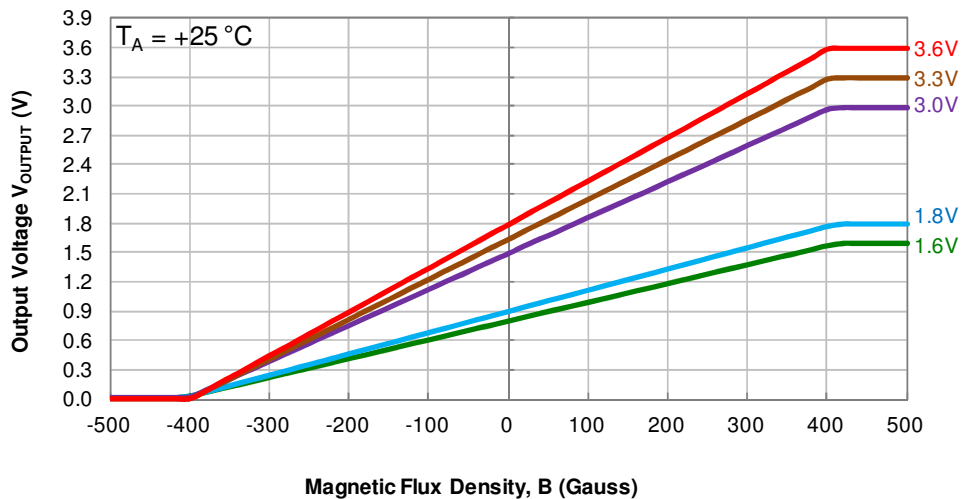

**Transfer Curve – Output Voltage vs. Magnetic Flux Density**

**Application Note** (cont.)

**Span Linearity**

The coordinate of transition points (V0~V255 and B0~B254) can be extracted from a transfer curve. Span linearity is defined and based on these coordinate points.

Span linearity is defined as linearity arising from sensitivity differences between the maximum flux density range and half of the range for positive and negative flux density. Referring to the diagram below, north field span linearity LIN- and south field span linearity LIN+ are given by

$$LIN- = \frac{(V0 - V127)/(B0 - B127)}{(V64 - V127)/(B64 - B127)}$$

$$LIN+ = \frac{(V254 - V127)/(B254 - B127)}{(V190 - V127)/(B190 - B127)}$$

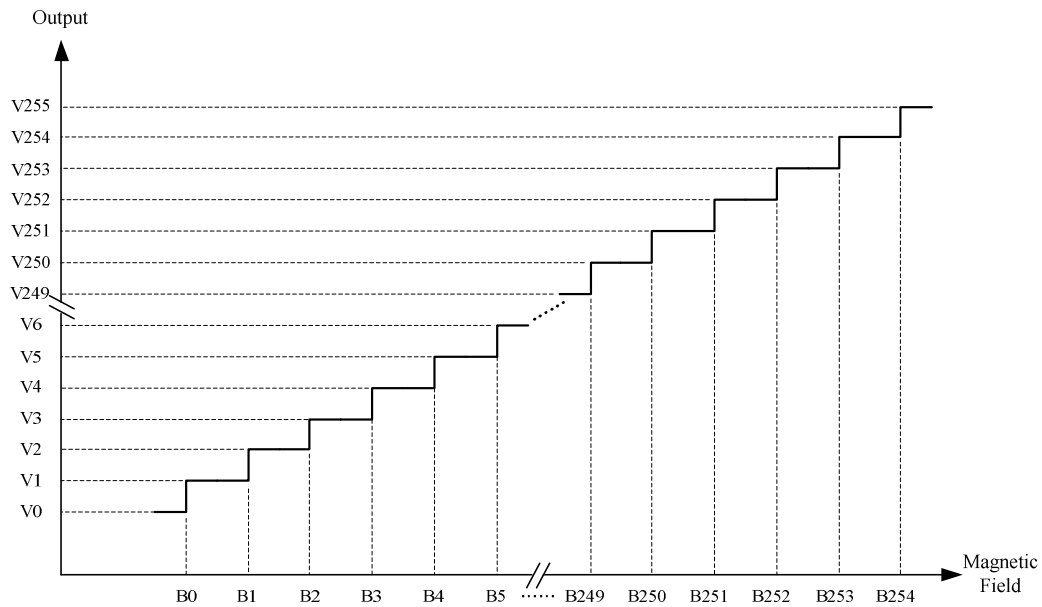

## Typical Operating Characteristics

### Average Supply Current

Sleep Mode

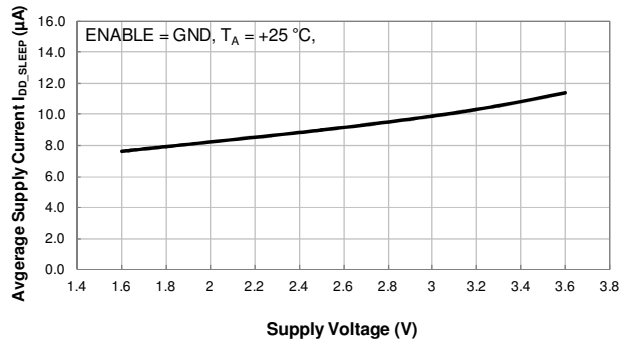

Average Supply Current (ENABLE = GND) vs Supply Voltage

Sleep Mode

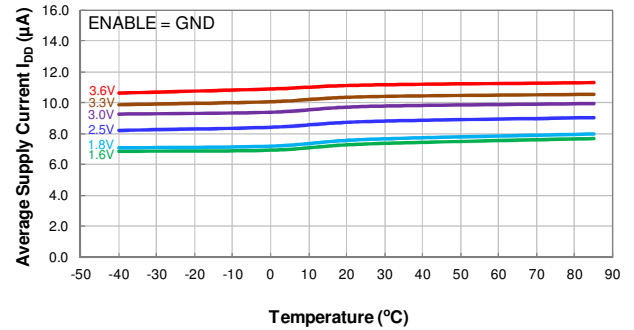

Average Supply Current (ENABLE = GND) vs Temperature

External Drive Mode - 20Hz Sample Rate

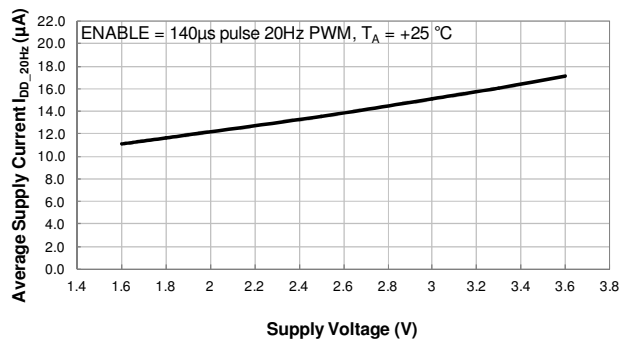

Average Supply Current (ENABLE = PWM) vs Supply Voltage

External Drive Mode - 20Hz Sample Rate

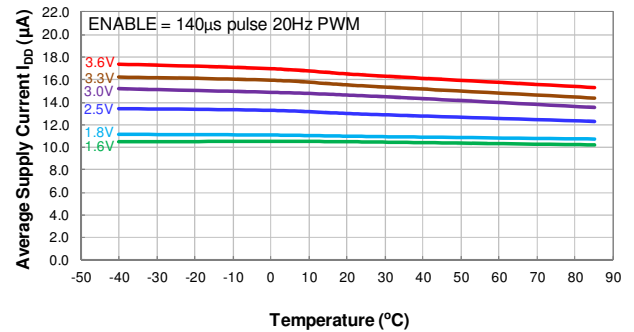

Average Supply Current (ENABLE = PWM) vs Temperature

Auto-Run Mode - 6.25kHz Sampling Rate

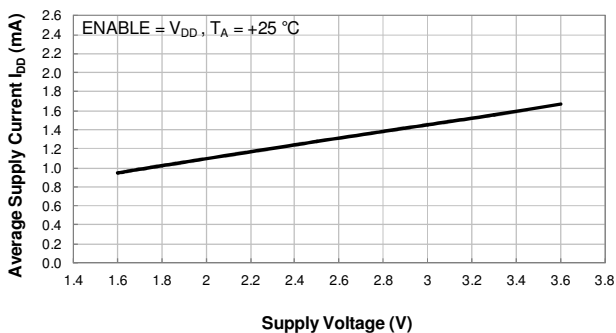

Average Supply Current (ENABLE =  $V_{DD}$ ) vs Supply Voltage

Auto-Run Mode Mode - 6.25kHz Sample Rate

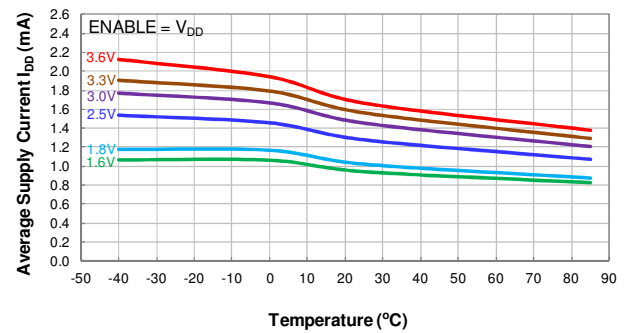

Average Supply Current (ENABLE =  $V_{DD}$ ) vs Temperature

**Typical Operating Characteristics** (continued)

**Typical Initial Power On Time**

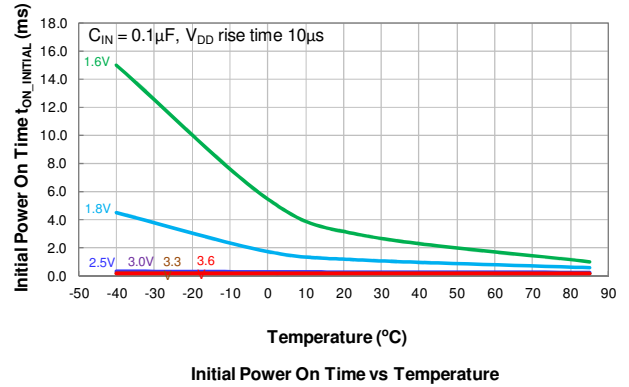
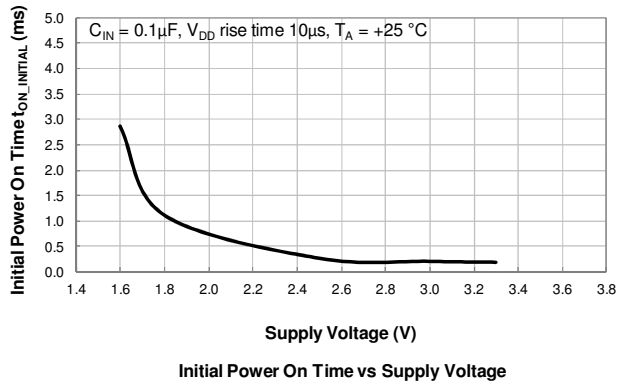

**Typical Sensitivity**

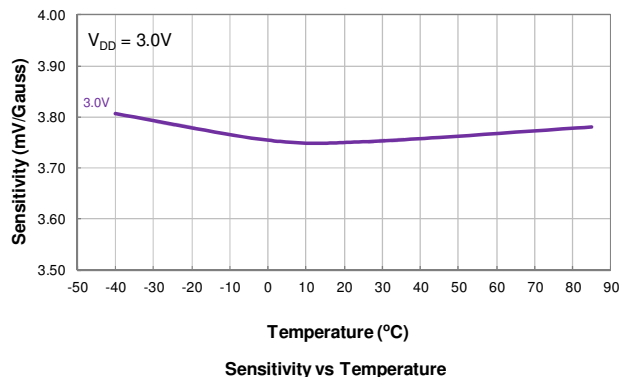
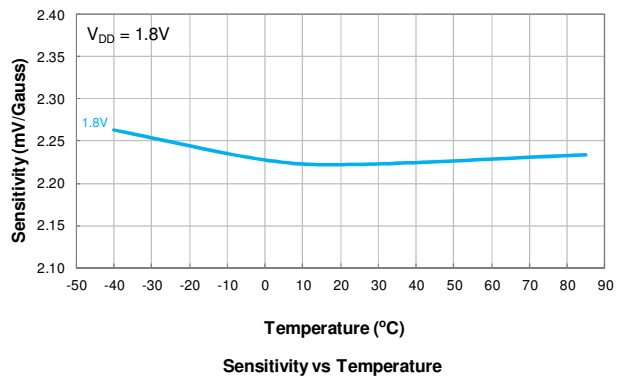
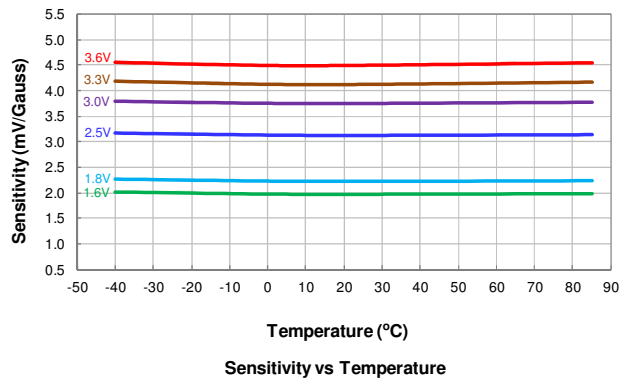
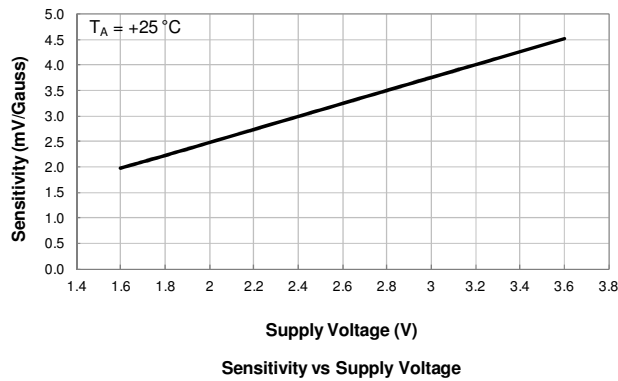

**Typical Operating Characteristics (cont.)**

**Typical Transfer Curves**

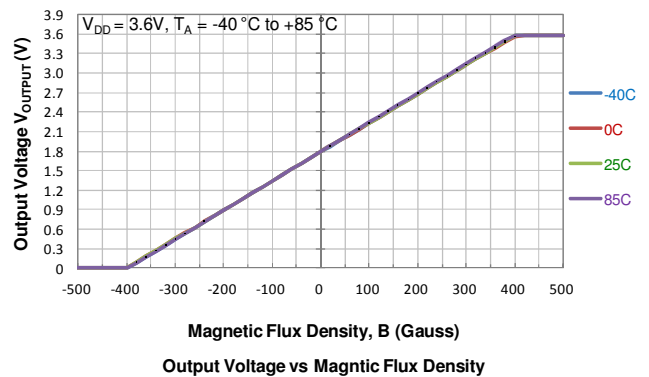
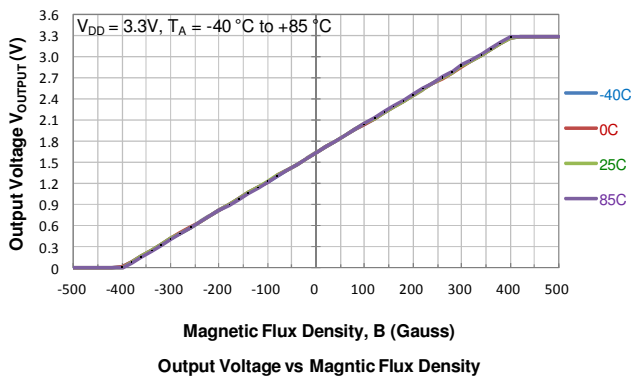
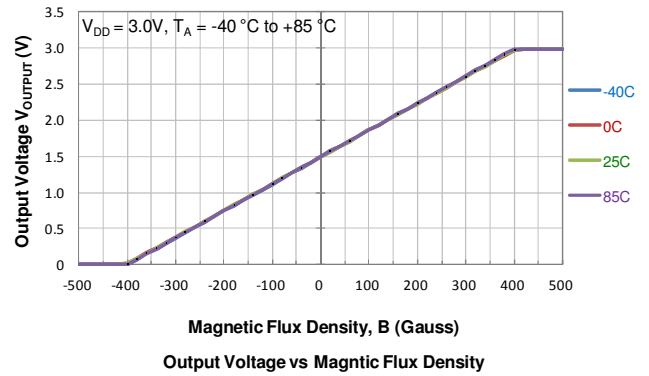
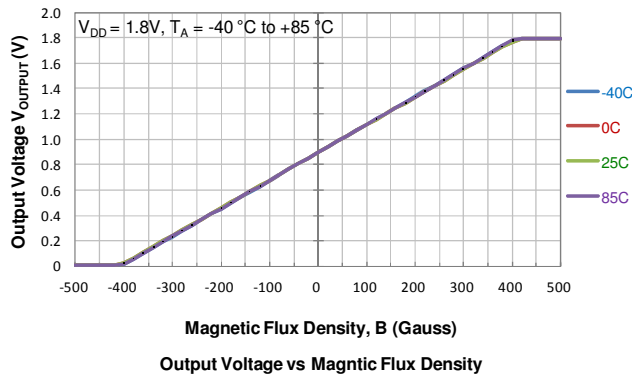
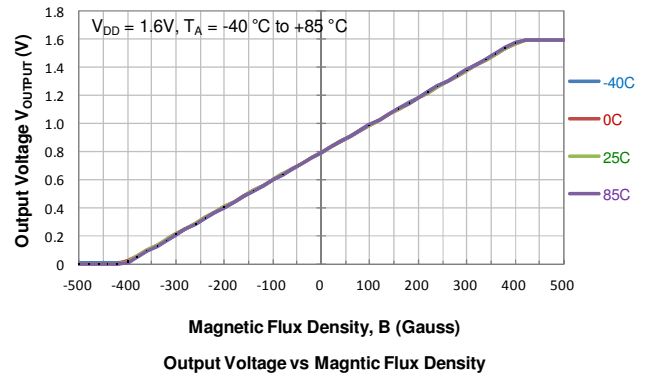
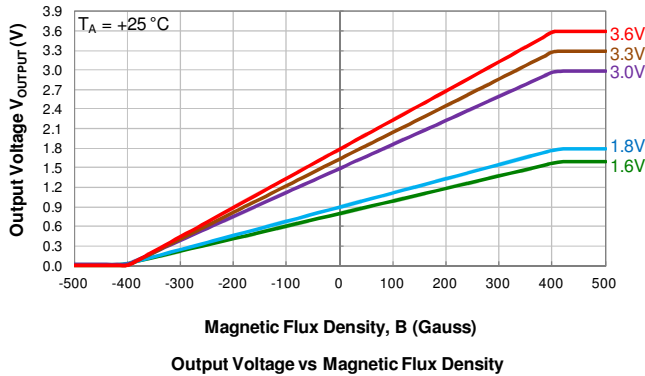

**Typical Operating Characteristics** (cont.)

**Typical Null Voltage:** Output Voltage at B = 0+ Gauss (Note 16)

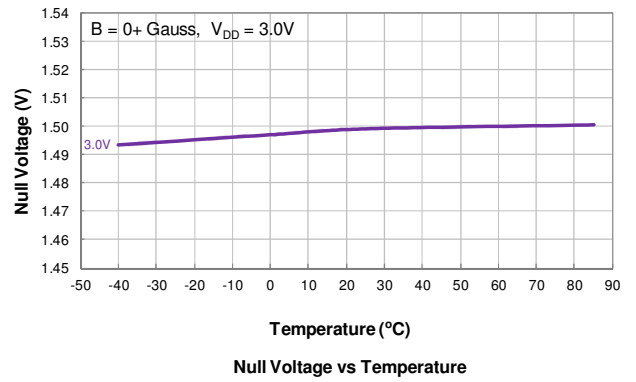
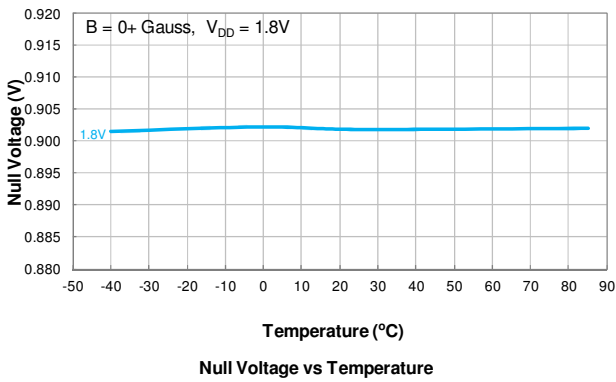
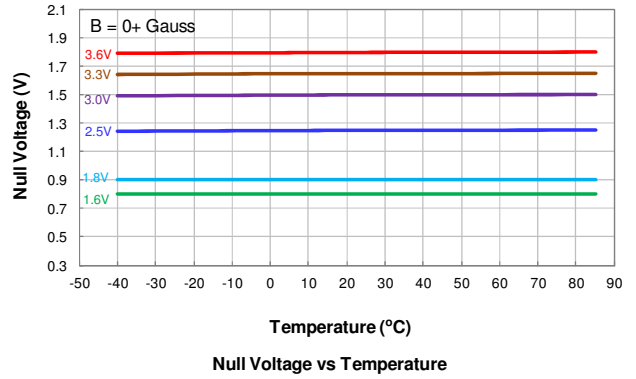
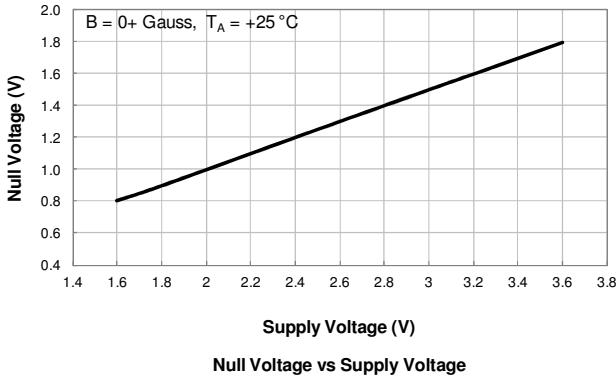

Note: 16. Null voltage is the voltage with magnetic flux density B = 0G at the sensor. B = 0G is also the transition point at  $V_{DD} \cdot 127/128$  for internal ADC and DAC. To avoid the transition point fluctuation during measurement of null voltage, B = 0+ Gauss (e.g. 0.5G which is smaller than the 1LSB gauss step of 3.125G) is used. See definition of the null voltage in application section.

**Typical Operating Characteristics** (cont.)

**Typical Null Voltage Offset:** (Output Voltage -  $V_{DD}/2$ ) at  $B = 0+$  Gauss (Note 16)

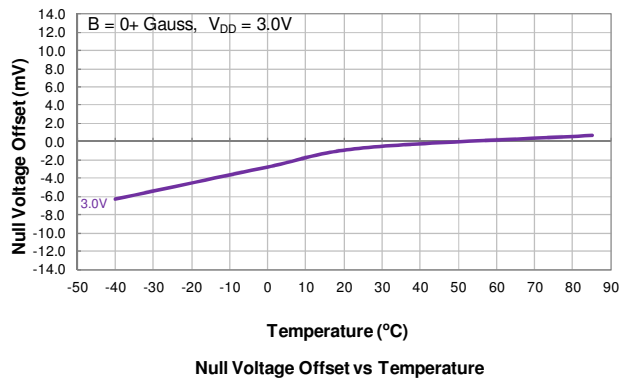
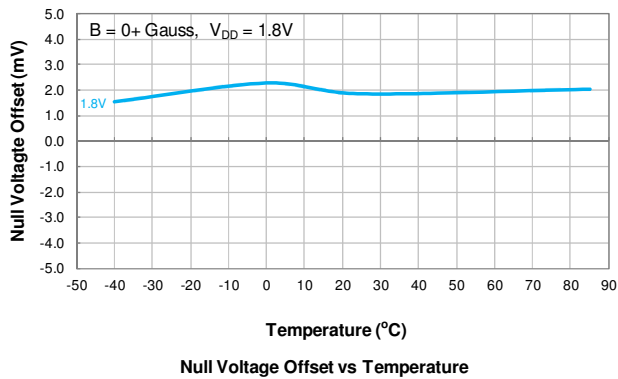
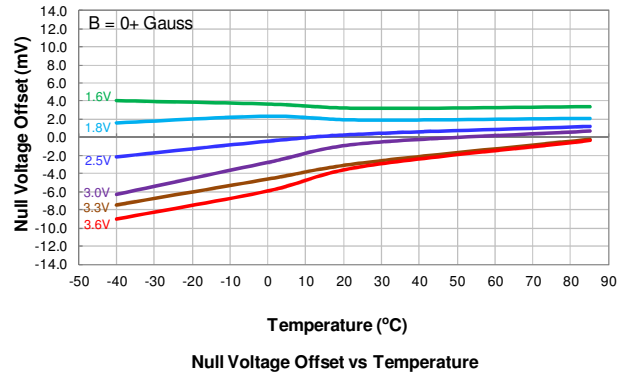
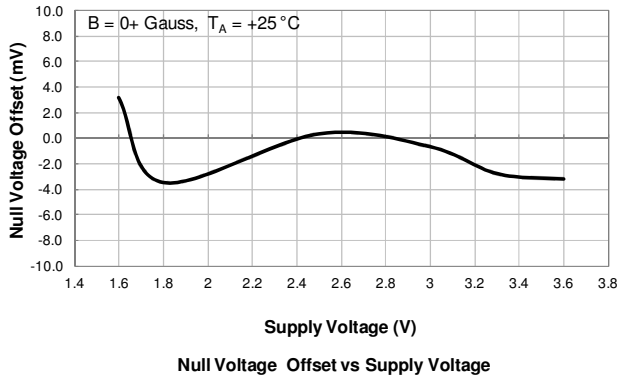

Note: 16. Null voltage is the voltage with magnetic flux density  $B = 0$ G at the sensor.  $B = 0$ G is also the transition point at  $V_{DD} \cdot 127/128$  for internal ADC and DAC. To avoid the transition point fluctuation during measurement of null voltage,  $B = 0+$  Gauss (e.g. 0.5G which is smaller than the 1LSB gauss step of 3.125G) is used. See definition of the null voltage in application section.

**Ordering Information**

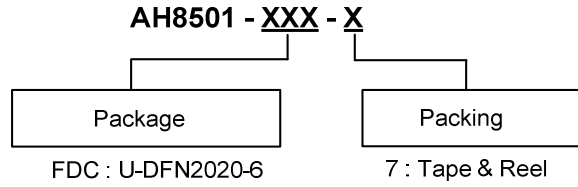

Part Number	Package Code	Packaging	7" Tape and Reel	
			Quantity	Part Number Suffix
AH8501-FDC-7	FDC	U-DFN2020-6	3,000/Tape & Reel	-7

**Marking Information**

(1) Package Type: U-DFN2020-6

( Top View )

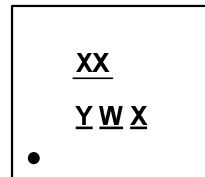

XX : Identification Code  
Y : Year : 0~9  
W : Week : A~Z : 1~26 week;  
 a~z : 27~52 week; z represents  
 52 and 53 week  
X : Internal Code

Part Number	Package	Identification Code
AH8501-FDC-7	U-DFN2020-6	KR



**Package Outline Dimensions** (All dimensions in mm.)

Please see AP02002 at <http://www.diodes.com/datasheets/ap02002.pdf> for the latest version.

(1) Package Type: U-DFN2020-6

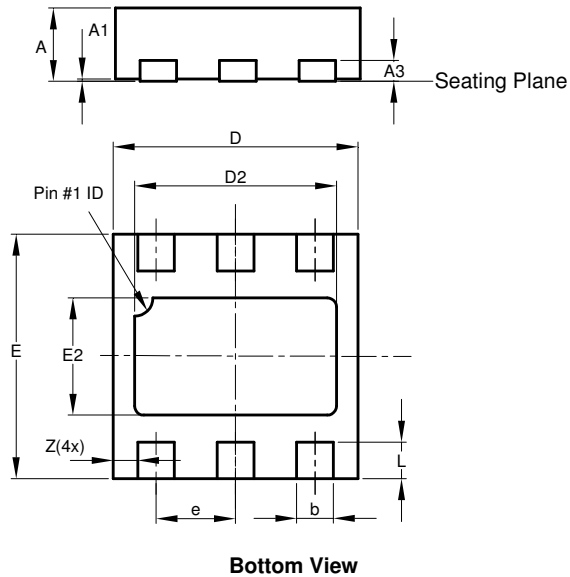

U-DFN2020-6 Type C			
Dim	Min	Max	Typ
A	0.57	0.63	0.60
A1	0.00	0.05	0.02
A3	-	-	0.15
b	0.25	0.35	0.30
D	1.95	2.075	2.00
D2	1.55	1.75	1.65
E	1.95	2.075	2.0
E2	0.86	1.06	0.96
e	-	-	0.65
L	0.25	0.35	0.30
Z	-	-	0.20
All Dimensions in mm			

Bottom View

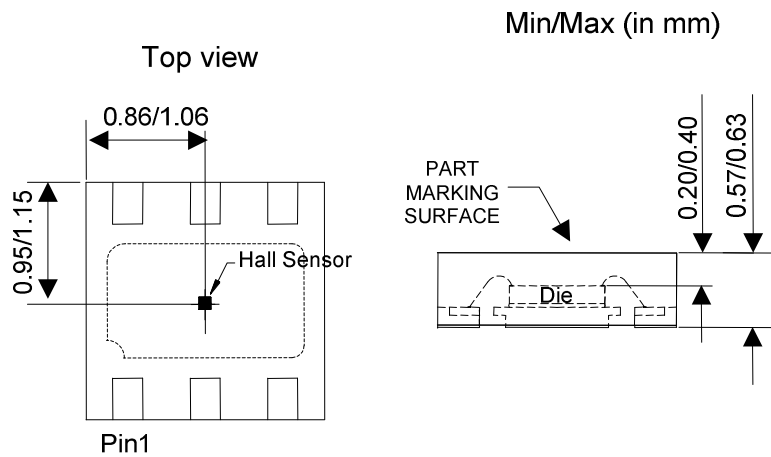

Sensor Location (TBD)

**Suggested Pad Layout**

Please see AP02001 at <http://www.diodes.com/datasheets/ap02001.pdf> for the latest version.

(1) Package Type: U-DFN2020-6

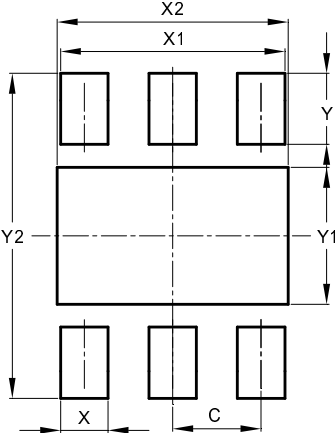

Dimensions	Value (in mm)
C	0.650
X	0.350
X1	1.650
X2	1.700
Y	0.525
Y1	1.010
Y2	2.400

**IMPORTANT NOTICE**

DIODES INCORPORATED MAKES NO WARRANTY OF ANY KIND, EXPRESS OR IMPLIED, WITH REGARDS TO THIS DOCUMENT, INCLUDING, BUT NOT LIMITED TO, THE IMPLIED WARRANTIES OF MERCHANTABILITY AND FITNESS FOR A PARTICULAR PURPOSE (AND THEIR EQUIVALENTS UNDER THE LAWS OF ANY JURISDICTION).

Diodes Incorporated and its subsidiaries reserve the right to make modifications, enhancements, improvements, corrections or other changes without further notice to this document and any product described herein. Diodes Incorporated does not assume any liability arising out of the application or use of this document or any product described herein; neither does Diodes Incorporated convey any license under its patent or trademark rights, nor the rights of others. Any Customer or user of this document or products described herein in such applications shall assume all risks of such use and will agree to hold Diodes Incorporated and all the companies whose products are represented on Diodes Incorporated website, harmless against all damages.

Diodes Incorporated does not warrant or accept any liability whatsoever in respect of any products purchased through unauthorized sales channel. Should Customers purchase or use Diodes Incorporated products for any unintended or unauthorized application, Customers shall indemnify and hold Diodes Incorporated and its representatives harmless against all claims, damages, expenses, and attorney fees arising out of, directly or indirectly, any claim of personal injury or death associated with such unintended or unauthorized application.

Products described herein may be covered by one or more United States, international or foreign patents pending. Product names and markings noted herein may also be covered by one or more United States, international or foreign trademarks.

This document is written in English but may be translated into multiple languages for reference. Only the English version of this document is the final and determinative format released by Diodes Incorporated.

**LIFE SUPPORT**

Diodes Incorporated products are specifically not authorized for use as critical components in life support devices or systems without the express written approval of the Chief Executive Officer of Diodes Incorporated. As used herein:

A. Life support devices or systems are devices or systems which:

1. are intended to implant into the body, or
2. support or sustain life and whose failure to perform when properly used in accordance with instructions for use provided in the labeling can be reasonably expected to result in significant injury to the user.

B. A critical component is any component in a life support device or system whose failure to perform can be reasonably expected to cause the failure of the life support device or to affect its safety or effectiveness.

Customers represent that they have all necessary expertise in the safety and regulatory ramifications of their life support devices or systems, and acknowledge and agree that they are solely responsible for all legal, regulatory and safety-related requirements concerning their products and any use of Diodes Incorporated products in such safety-critical, life support devices or systems, notwithstanding any devices- or systems-related information or support that may be provided by Diodes Incorporated. Further, Customers must fully indemnify Diodes Incorporated and its representatives against any damages arising out of the use of Diodes Incorporated products in such safety-critical, life support devices or systems.

Copyright © 2015, Diodes Incorporated

[www.diodes.com](http://www.diodes.com)