



## 1. Overview

### 1.1 General Description

The **Ai339** is a 440K pixels CCD area sensor for PAL 1/3 inch video cameras. Buried photodiodes and micro lenses are adopted for low noise, low smear and high sensitivity. A chrominance signal is achieved by the adoption of Yellow, Magenta, Cyan and Green complementary color mosaic filters. This product also has the features of strong anti-blooming and electronic shutter with variable charge-storage time.

### 1.2 Features

- Micro lens arrays for high sensitivity
- Ye, Mg, Cy and G complementary color mosaic filters
- Excellent blooming suppression
- TTL level(3.3V) operation on HCCD & RG electrodes
- 16 pin plastic DIP type package
- Variable electronic shutter of 1/50 to 1/100,000 sec
- High sensitivity and low smear
- Low image lag

### 1.3 Device Constitution

- Architecture : IT - CCD
- Optical size : 1/3 inch format
- Number of effective pixels :  
752 (H) x 582 (V) = 437,664 pixels
- Number of total pixels :  
795 (H) x 596 (V) = 473,820 pixels
- Pixel size : 6.50 (H) x 6.25 (V)  $\mu\text{m}^2$
- Optical black area  
Horizontal direction : Front 3 pixels Rear 40 pixels  
Vertical direction : Front 12 pixels Rear 2 pixels
- Number of dummy bits  
Horizontal direction : Front 22 pixels Rear - pixels  
Vertical direction : Front 1 pixels Rear - pixels

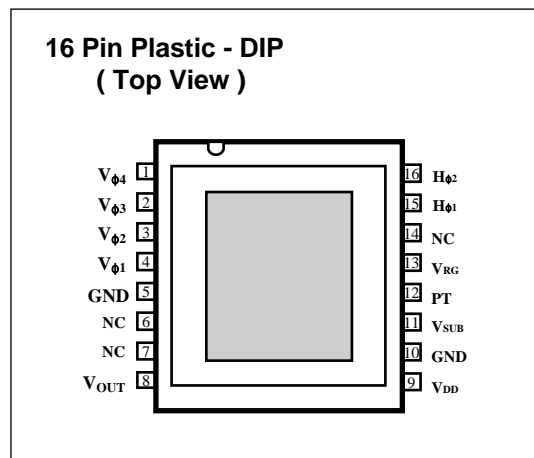

### Optical black position ( Top View )

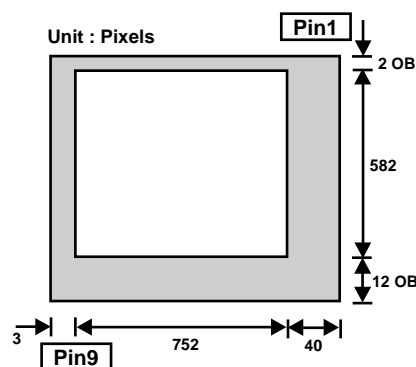

### 1.4 Pin Arrangement

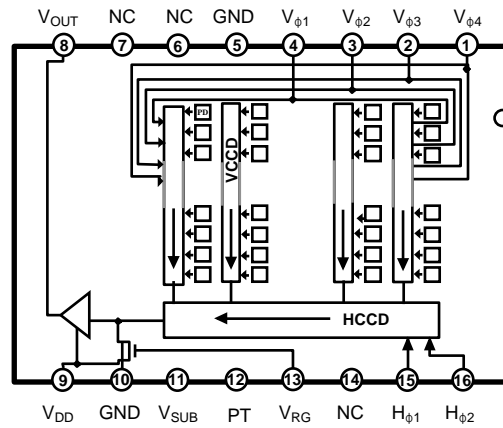

### 1.5 Pin Descriptions

Pin	Symbol	Description	Pin	Symbol	Description
1	$\Phi V4$	Vertical register transfer clock 4	9	VDD	Output amplifier drain bias
2	$\Phi V3$	Vertical register transfer clock 3	10	GND	Ground
3	$\Phi V2$	Vertical register transfer clock 2	11	$\Phi SUB$	Substrate (Overflow drain) bias
4	$\Phi V1$	Vertical register transfer clock 1	12	PT	Protection bias
5	GND	Ground	13	$\Phi RG$	Reset gate clock
6	NC	No connection	14	NC	No connection
7	NC	No connection	15	$\Phi H1$	Horizontal register transfer clock 1
8	VO	CCD output signal	16	$\Phi H2$	Horizontal register transfer clock 2

### 1.6 Absolute Maximum Ratings

Symbols	Relative to GND (Unit : V)	
	Min.	Max.
VDD	- 0.2	15.0
PT	- 7.5	0.2
GND	Reference	
$\Phi RG$	- 0.2	12.0
$\Phi SUB$	- 0.2	29.0
$\Phi H1, \Phi H2$	- 0.2	5.0
$\Phi V1$	- 7.0	14.0
$\Phi V2, \Phi V3, \Phi V4$	- 7.0	7.0
VO	- 0.2	15.0

## 1.7 Temperature Ratings

<b>Symbols</b>	<b>Min</b>	<b>Max</b>	<b>Unit</b>
Operating Temperature	-20	75	°C
Storage Temperature	-30	85	°C

- Note) •Temperature rating is defined with the ambient temperature of sensor
- About the storage temperature of CCD, and local heat stress at the time of solder mounting, it provides in "Notes on Device Handling".
  - Operating temperature Is not guaranteed the characteristics.

## 2. Electrical Specification

### 2.1 Operating Voltage Conditions

Symbol		Operating conditions			Unit	Notes
		Min.	Typ.	Max.		
VDD		11.5	12.0	12.5	V	
PT		- 6.5	- 6.0	- 5.5	V	
GND		-	0.0	-	V	
ΦRG	H - L	3.0	3.3	3.6	V	*1
	Bias	( Internal bias )				
ΦSUB	H - L	17.0	18.0	19.0	V	*2
	Bias	( Internal bias )				
ΦH1, ΦH2	H	3.0	3.3	3.6	V	*3
	L	- 0.2	0.0	0.2		
ΦV1	H	11.5	12.0	12.5	V	*4
	M	- 0.2	0.0	0.2		
	L	- 6.5	- 6.0	- 5.5		
ΦV2, ΦV3, ΦV4	M	- 0.2	0.0	0.2	V	
	L	- 6.5	- 6.0	- 5.5		

Note) Driving voltage value of the above table indicates the voltage value in each Pad of the image sensor.

Note) \*1 : Reset gate (ΦRG)

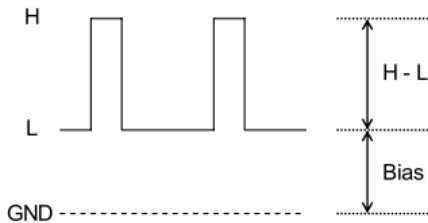

Note) \*2 : Substrate (ΦSUB)

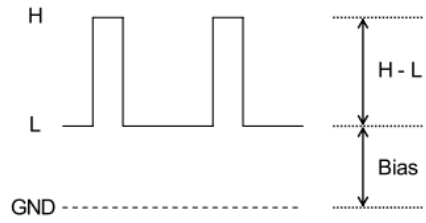

Note) \*4 : Horizontal (ΦH1, ΦH2)

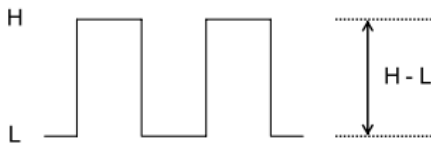

Note) \*4 : Vertical (ΦV1 to ΦV4)

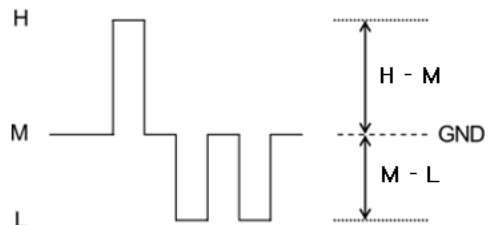

### 3. Imaging Characteristics

#### 3.1 Imaging Characteristics Testing Conditions

(1) The definition of standard imaging conditions.

Standard imaging conditions consist of standard optical system conditions, standard drive voltage conditions, and standard drive timing conditions.

(2) Standard optical system conditions.

The conditions of the measurement optical system show below are made into standard optical conditions.

- 1 ) Light source color temperature : 4,800 K
- 2 ) Camera lens iris diaphragm : F11 considerable
- 3 ) IR cut filter : CM500S, t = 1.0 mm
- 4 ) Illuminance of the CCD surface : 1.0 lx ( After IR cut filter passage ).
- 5 ) Color filter ( When required ) : Blue filter : B440 , t = 2.5 mm  
: Red filter : R64 , t = 2.5 mm  
: Green filter : BW550 , t = 4.45 mm

(3) Standard drive voltage conditions.

the conditions driven with the typical value in operating voltage are made into standard drive voltage conditions.

(4) Standard drive timing conditions.

It is measurement in the drive timing of standard timing chart.

### 3.2 Imaging Characteristics

Item	Symbol	Min.	Typ.	Max.	Unit	Conditions	Test Temp	Test method	Notes	
Saturation signal	Vsat	1,000	-	-	mV	60.8 lx illuminance	60℃	3.3.1		
Sensitivity	So	200	250	-	mV / lx	Standard illuminance accumulation time 1 / 50 sec	35℃	3.3.2		
Smear	Sm	-	-130	-105	dB	1,900 lx illuminance	35℃	3.3.3		
Vertical transfer efficiency	Vtte	99.5	-	-	%	Standard illuminance	35℃	3.3.4		
Horizontal transfer efficiency	Htte	99.0	-	-				3.3.5		
Signal shading	Shd	-	-	20	%	Standard illuminance	35℃	3.3.6		
Uniformity between video signal channels	Red	△Sr	-	-	10	%	Standard illuminance	35℃	3.3.7	
	Blue	△Sb	-	-	10				3.3.8	
Flicker	Y	FlkY	-	-	2.0	%	Standard illuminance	35℃	3.3.9	
	Cr	FlkCr	-	-	5.0				3.3.10	
	Cb	FlkCb	-	-	5.0				3.3.11	
Line crawl	R	LcR	-	-	3.0	%	Standard illuminance ( Each color filter addition )	35℃	3.3.12	
	B	LcB	-	-	3.0				3.3.13	
	G	LcG	-	-	3.0				3.3.14	
	W	LcW	-	-	3.0				3.3.15	
Dark signal	Vdk	-	-	1.0	mV	Dark condition	60℃	3.3.16		
Lag	Lag	-	-	0.5	%	strobe light	35℃	3.3.17		

[ Measurement system ]

The test point is assumed to be the output point of the following circuit block ( Both of the  $\gamma$  of AMP and the operation processing are 1 ) The device output voltage ( Unit : mV ) of dark characteristics and temperature white defect is converted from screen output by gain of AMP

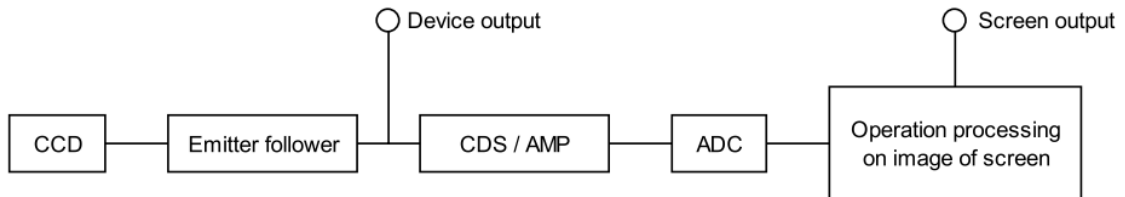

### 3.3 Imaging Characteristics Tested Procedures

#### 3.3.1. Saturation signal

- 1 ) Set 60.8 lx illumination condition, then measure the signal output.
- 2 ) Detect the average value of the test area
- 3 ) See figure 1 below for the Test area

#### 3.3.2. Sensitivity

- 1) Set 1.0 lx illumination condition, then measure the signal output.
- 2) Detect sensitivity with the following formula.
- 3) See figure 1 below for the Test area

$$So [ mV / lx ] = ( Ye + Cy + Mg + G ) / 2$$

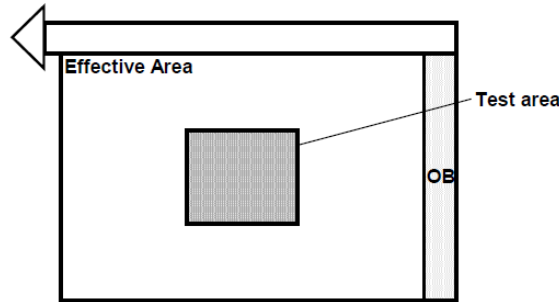

Figure 1. Saturation signal and Sensitivity test area.

#### 3.3.3. Smear

- 1) Set 0 lx illumination condition, then measure the signal output without readout PD ( IMAGE0 ).
- 2) Set 1900 lx illumination condition measure the signal output readout PD ( IMAGE1 ).
- 3) Subtract IMAGE0 from IMAGE1 as a reference level if the signal output.
- 4) Divide Smear test area to 20 areas, and detect the average value in each area.
- 5) Select the maximum value from the average values ( Smear\_max ).
- 6) Detect Smear with the following formula.
- 7) See figure 2 below for the Test area.

$$Sm [ 1 / 10 V : dB ] = 20 \text{ Log } ( \text{Smear\_max} / ( \text{Sensitivity} \times 1900 \times 10 ) )$$

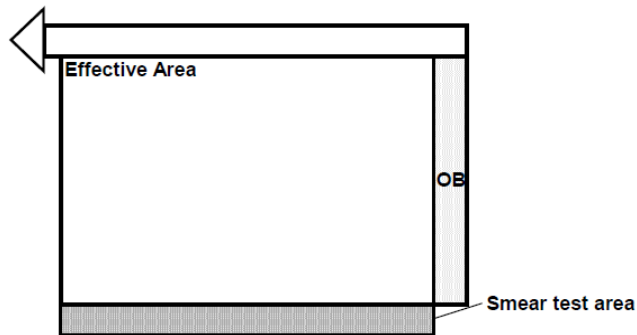

Figure 2. Smear test area.

3.3.4. Vertical transfer efficiency

- 1) Set 1.0 lx illumination condition, then measure the signal output.
- 2) Detect average value of horizontal last line in effective area ( V\_EFF ).
- 3) Detect average value of horizontal first line in OB area ( V\_OB ).
- 4) Detect average value of horizontal line in reference area ( V\_REF ).
- 5) Detect Vertical transfer efficiency with the following formula
- 6) See figure 3 below for the Test area.

$$Vtte [ \% ] = ( ( ( V\_EFF - V\_REF ) - ( V\_OB - V\_REF ) ) / ( V\_EFF - V\_REF ) ) \times 100$$

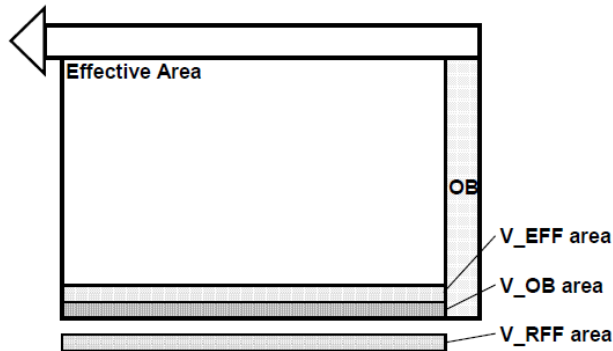

Figure 3. Vertical transfer efficiency test area.

3.3.5. Horizontal transfer efficiency

- 1) Set 1.0 lx illumination condition, then measure the signal output.
- 2) Detect average value of vertical last line in effective area ( H\_EFF ).
- 3) Detect average value of vertical first line in OB area ( H\_OB ).
- 4) Detect average value of vertical line in reference area ( H\_REF ).
- 5) Detect Horizontal transfer efficiency with the following formula
- 6) See figure 4 below for the Test area.

$$Htte [ \% ] = ( ( ( H\_EFF - H\_REF ) - ( H\_OB - H\_REF ) ) / ( H\_EFF - H\_REF ) ) \times 100$$

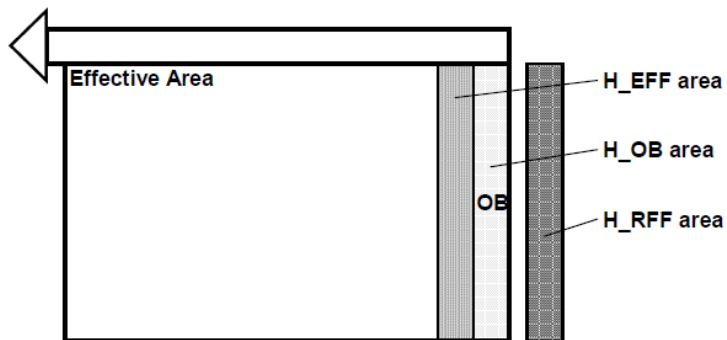

Figure 4. Horizontal transfer efficiency.



**3.3.6. Signal shading**

- 1) Set 1.0 lx illumination condition, then measure the signal output.
- 2) Make composition of luminance signal Y.
- 3) Apply low pass filter to luminance signal Y ( ex : rank filter and convolution filter ).
- 4) Measure the maximum and minimum value of luminance signal Y.
- 5) Detect Signal shading with the following formula.

$$\text{Shd [ \% ]} = ( ( Y.\text{max} - Y.\text{min} ) / Y.\text{mean} ) \times 100$$

**3.3.7. Uniformity between video signal channels : Red**

- 1) Set 1.0 lx illumination condition, then measure the signal output.
- 2) Make blue signal R – Y and luminance signal Y.
- 3) Apply low pass filter to chroma signal R – Y ( ex : rank filter and convolution filter ).
- 4) Measure the maximum and minimum value of blue chroma signal R – Y.
- 5) Detect  $\Delta Sr$  with the following formula.

$$\Delta Sr [ \% ] = ( ( R - Y ).\text{max} - ( R - Y ).\text{min} ) / Y.\text{mean} ) \times 100$$

**3.3.8. Uniformity between video signal channels : Blue**

- 1) Set 1.0 lx illumination condition, then measure the signal output.
- 2) Make red chroma signal B – Y and luminance signal Y.
- 3) Apply low pass filter to chroma signal B – Y ( ex : rank filter and convolution filter ).
- 4) Measure the maximum and minimum value of red chroma signal B – Y.
- 5) Detect  $\Delta Sb$  with the following formula.

$$\Delta Sb [ \% ] = ( ( B - Y ).\text{max} - ( B - Y ).\text{min} / Y.\text{mean} ) \times 100$$

**3.3.9. Flicker : Y**

- 1) Set 1.0 lx illumination condition, then measure the signal output
- 2) Measure odd field output value ( Y.ODD ).
- 3) Measure even field output ( Y.EVE ).
- 4) Detect Flicker Y with the following formula.

$$\text{FlkY [ \% ]} = \text{ABS} ( 2 \times ( Y.\text{ODD} - Y.\text{EVE} ) / ( Y.\text{ODD} + Y.\text{EVE} ) )$$

**3.3.10 Flicker : Cr**

- 1) Set 5.5 lx illumination condition with red filter, then measure the signal output.
- 2) Make red chroma signal R – Y.
- 3) Measure odd field output value ( CR.ODD ).
- 4) Measure even field output value ( CR.EVEN ).
- 5) Detect Flicker Cr with the following formula.

$$\text{FlkCr [ \% ]} = \text{ABS} ( 2 \times ( CR.\text{ODD} - CR.\text{EVE} ) / ( CR.\text{ODD} + CR.\text{EVE} ) )$$

3.3.11. Flicker : Cb

- 1) Set 5.5 lx illumination condition with blue filter, then measure the signal output.
- 2) Make blue chroma signal B – Y.
- 3) Measure odd field output value ( CB.ODD ).
- 4) Measure even field output value ( CB.EVE ).
- 5) Detect Flicker Cb with the following formula.

$$\text{FlkCb [ \% ]} = \text{ABS} ( 2 \times ( \text{CB.ODD} - \text{CB.EVE} ) / ( \text{CB.ODD} + \text{CB.EVE} ) ) \times 100$$

3.3.12. Line crawl : R

- 1) Set 5.5 lx illumination condition with red filter, then measure the signal output.
- 2) Make composition of luminance signal Y.
- 3) Apply low pass filter to Y ( ex : rank filter ).
- 3) Calculate difference between Y signal lines for the same field.
- 4) Select maximum difference  $\Delta$ ( LCLEV ) value.
- 5) Detect Line crawl R with the following formula.

$$\text{LcR [ \% ]} = \text{ABS} ( \text{LCLEV} / \text{Y.mean} ) \times 100$$

3.3.13. Line crawl : B

- 1) Set 5.5 lx illumination condition with blue filter, then measure the signal output.
- 2) Make composition of luminance signal Y.
- 3) Apply low pass filter to Y ( ex : rank filter ).
- 4) Calculate difference between Y signal line for the same field.
- 5) Select maximum difference  $\Delta$ ( LCLEV ) value.
- 6) Detect Line crawl B with the following formula.

$$\text{LcB [ \% ]} = \text{ABS} ( \text{LCLEV} / \text{Y.mean} ) \times 100$$

3.3.14. Line crawl : G

- 1) Set 5.5 lx illumination condition with green filter, then measure the signal output.
- 2) Make composition of luminance signal Y.
- 3) Apply low pass filter to Y ( ex : rank filter ).
- 4) Calculate difference between Y signal lines for the same field.
- 5) Select maximum difference  $\Delta$ ( LCLEV ) value.
- 6) Detect Line crawl G with the following formula.

$$\text{Lcg [ \% ]} = \text{ABS} ( \text{LCLEV} / \text{Y.mean} ) \times 100$$

3.3.15. Line crawl : W

- 1) Set 1.0 lx illumination condition
- 2) Make composition of luminance signal Y.
- 3) Apply low pass filter to Y ( ex : rank filter ).
- 4) Calculate difference between Y signal line for the same field.
- 5) Select maximum difference  $\Delta$ ( LCLEV ) value.
- 6) Detect Line crawl W with the following formula.

$$\text{LcW [ \% ]} = \text{ABS} ( \text{LCLEV} / \text{Y.mean} ) \times 100$$

3.3.16. Dark signal

- 1) Set the temperature to 60°C and 0.0 lx illumination condition, then measure the signal output.
- 2) Detect Dark signal with the following formula.
- 3) See figure 5 below for Test area

$$V_{dk} [mV] = (\text{average value of the effective area}) - (\text{average value of the horizontal idle transfer area})$$

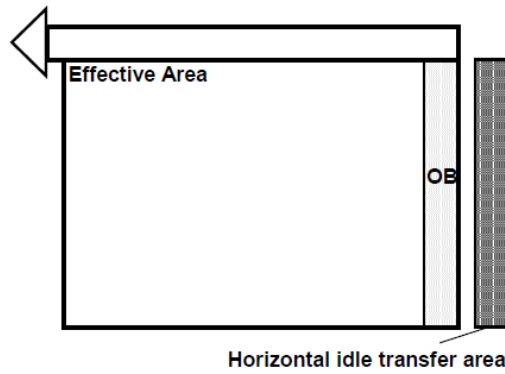

Figure 5. Dark signal.

3.3.17 Lag

- 1) Set the temperature to 35°C, strobe light and AFE gain 6dB condition.
- 2) Adjust the Y signal output value generated by strobe light to 200mV.
- 3) After setting the strobe light so that it strobes with the following timing, measure the residual signal (Ylag), and substitute the value into the following formula.

$$\text{Lag} [\%] = (Y_{lag}/200) \times 100(\%)$$

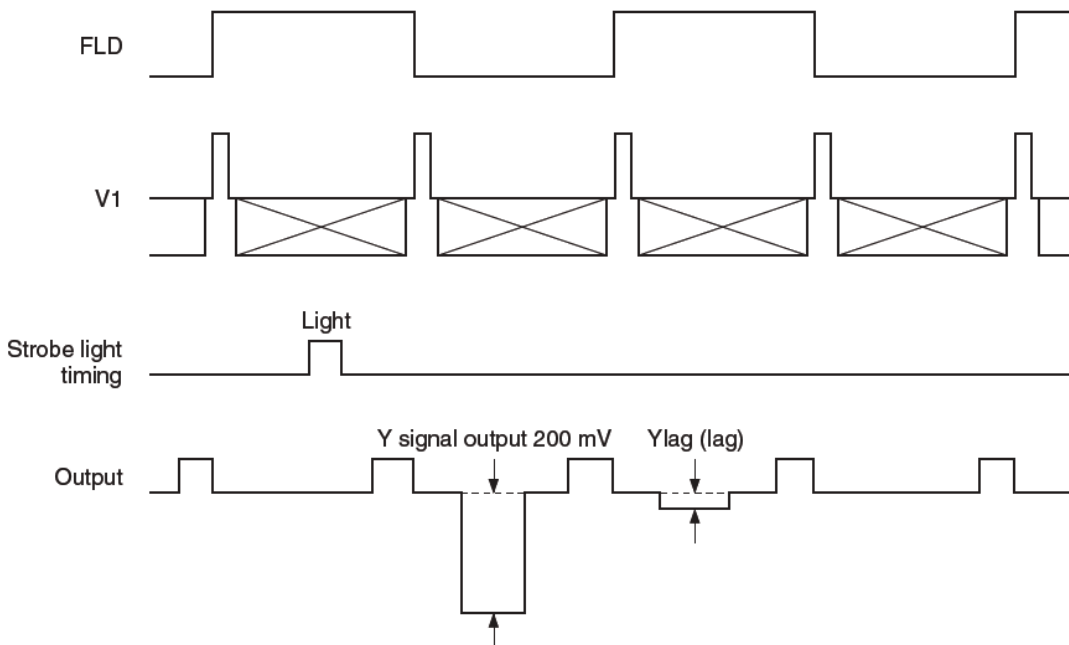
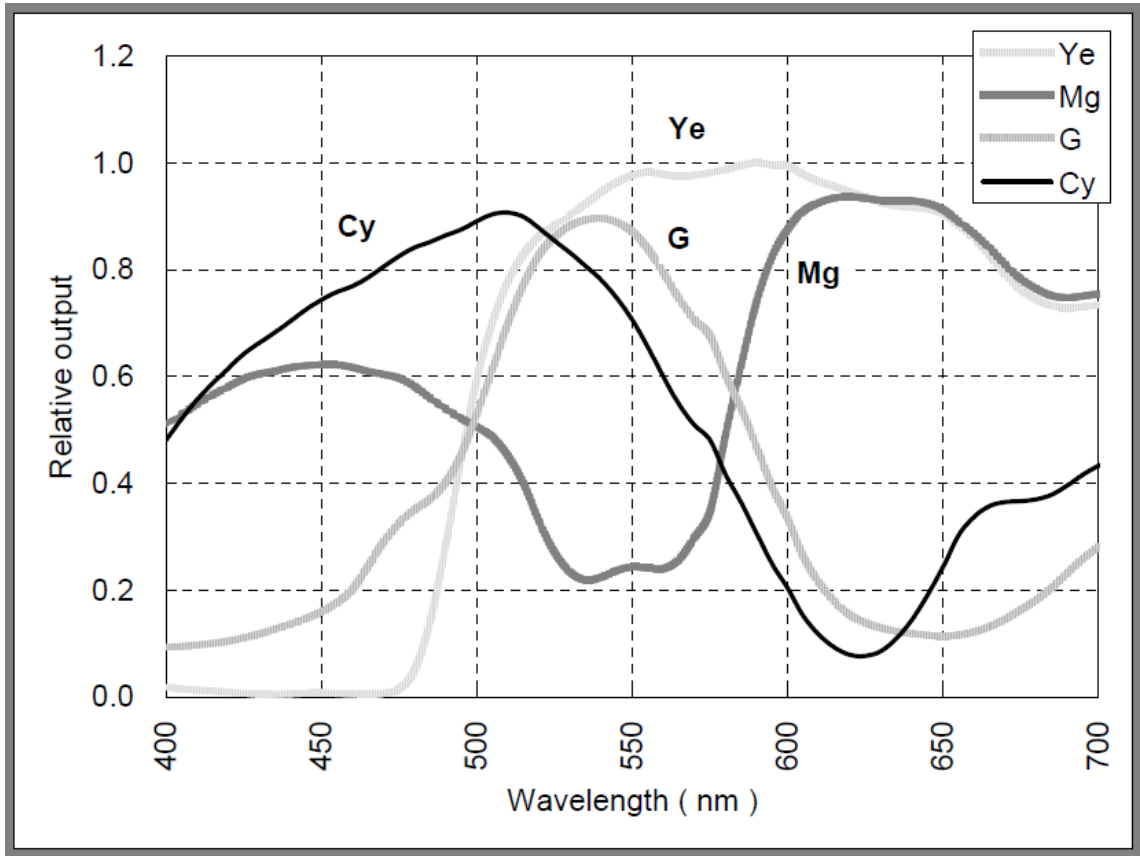

Figure 6. Lag test

### 4. Spectral characteristic

(Reference)



**5 Application**  
**5.1 Application Circuit**

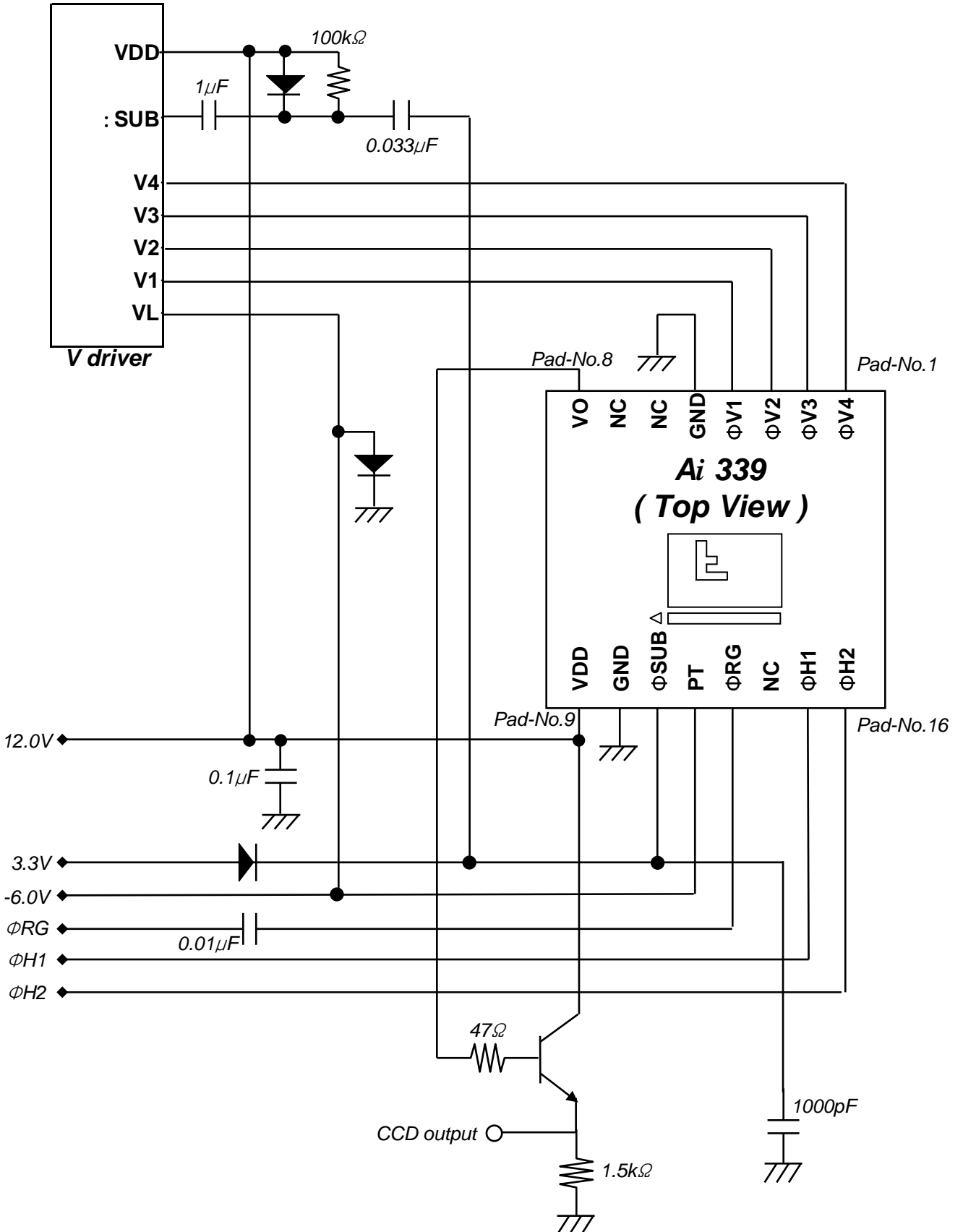

## 6. Drive condition

### 6.1. Power-on conditions

(1) Starting up power supply

- 1) First bring up the + 3.3 V system, making sure that the  $\Phi_{SUB}$  pin never becomes lower than the ground potential.
- 2) After that, bring up the +12.0V system ( $\Phi_{VH}$ , and VDD ) and the - 6.0 V system ( $\Phi_{VL}$  and PT ). These levels may be brought up at the same time, however avoid bringing these levels up extremely rapidly.
- 3) The only constraint on the time from the point the + 3.3 V system is brought up to the + 12.0 V and - 6.0 V systems are brought up is that it be long enough for the vertical driver logic system to start up.

(2) Ending power supply

Turn off power supply levels in the reverse order from the application sequence.

- 1) Bring down the + 12.0 V system ( $\Phi_{VH}$ , and ADD ) and the - 6.0 V system ( $\Phi_{VL}$  and PT ).
- 2) After that, turn off the + 3.3 V system.

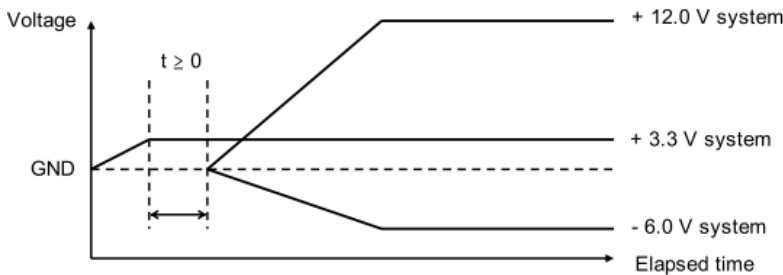

(3) Other notes

- 1) Design applications so that voltage do not exceed the absolute maximum ratings during the power supply startup transition period.

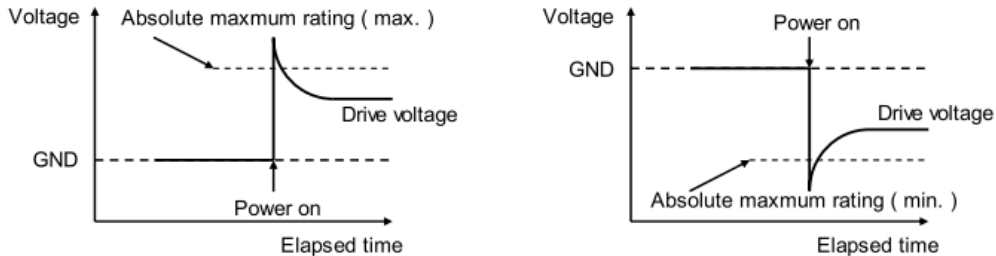

- 2) The condition  $PT \leq \Phi_{VL}$  must be maintained during the power supply on / off transition periods.

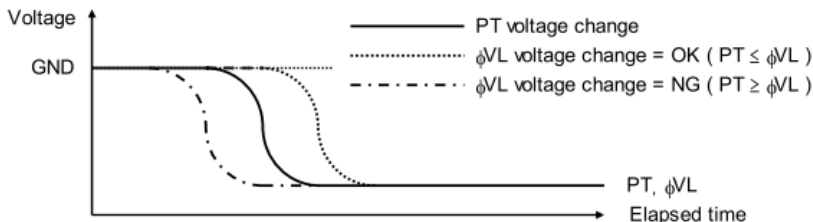

- 3) Do not connect or disconnect signals to or from the CCD voltage when power supply system are on

## 6.2 Timing Chart

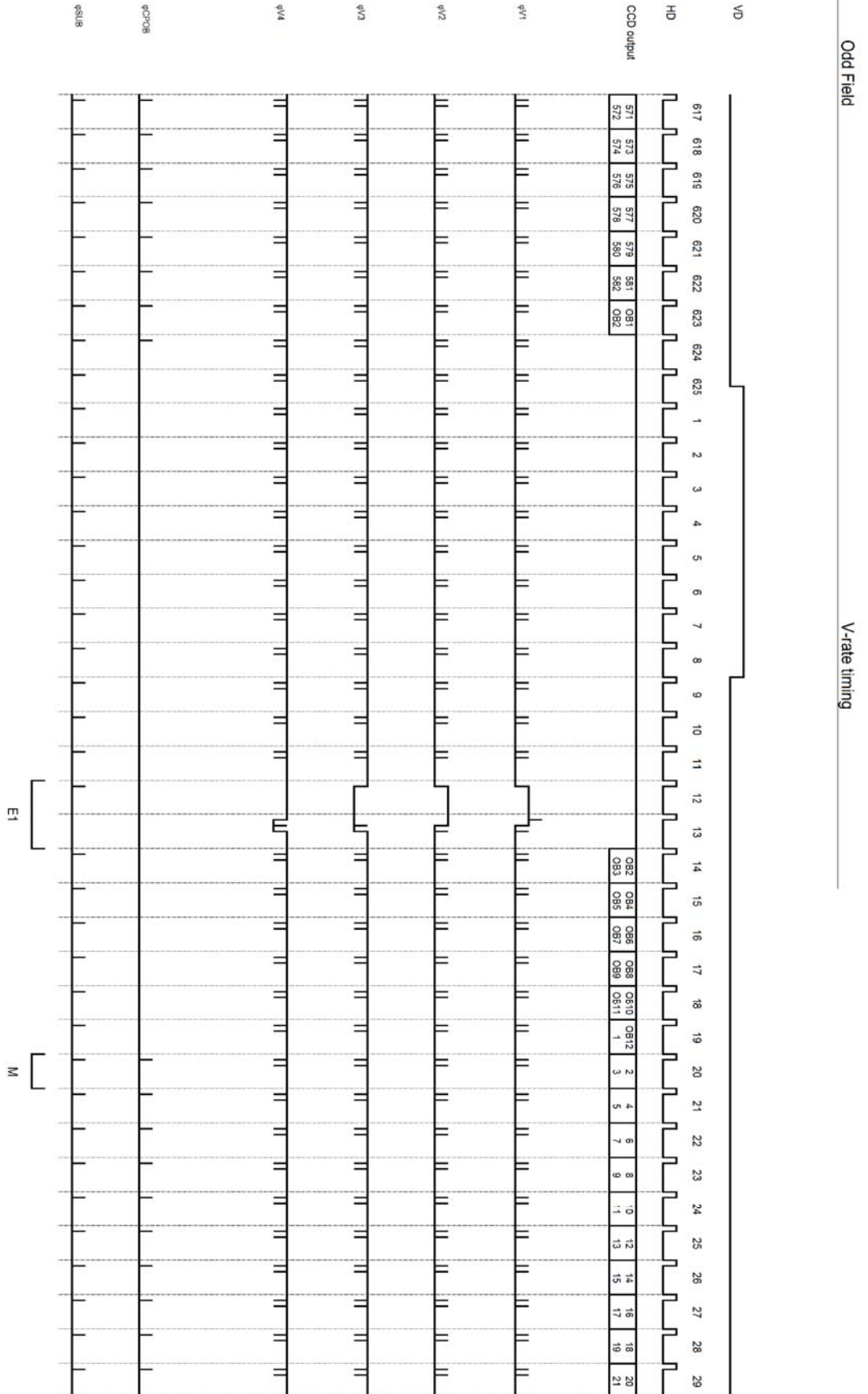

※ These CPOB pulses are reference. Please adjust CPOB pulses to AFE.

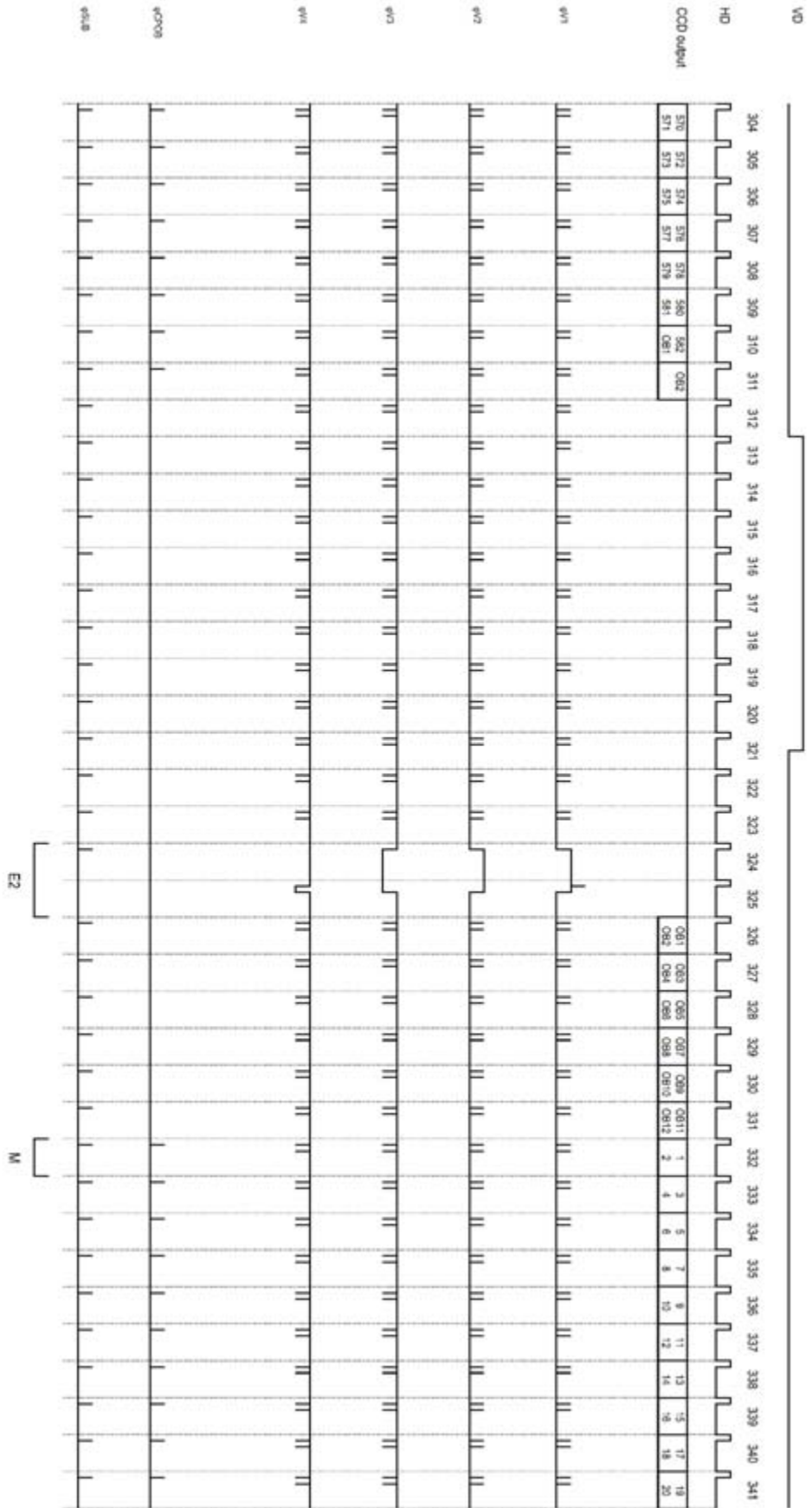

※ These CP0B pulses are reference. Please adjust CP0B pulses to AFE.



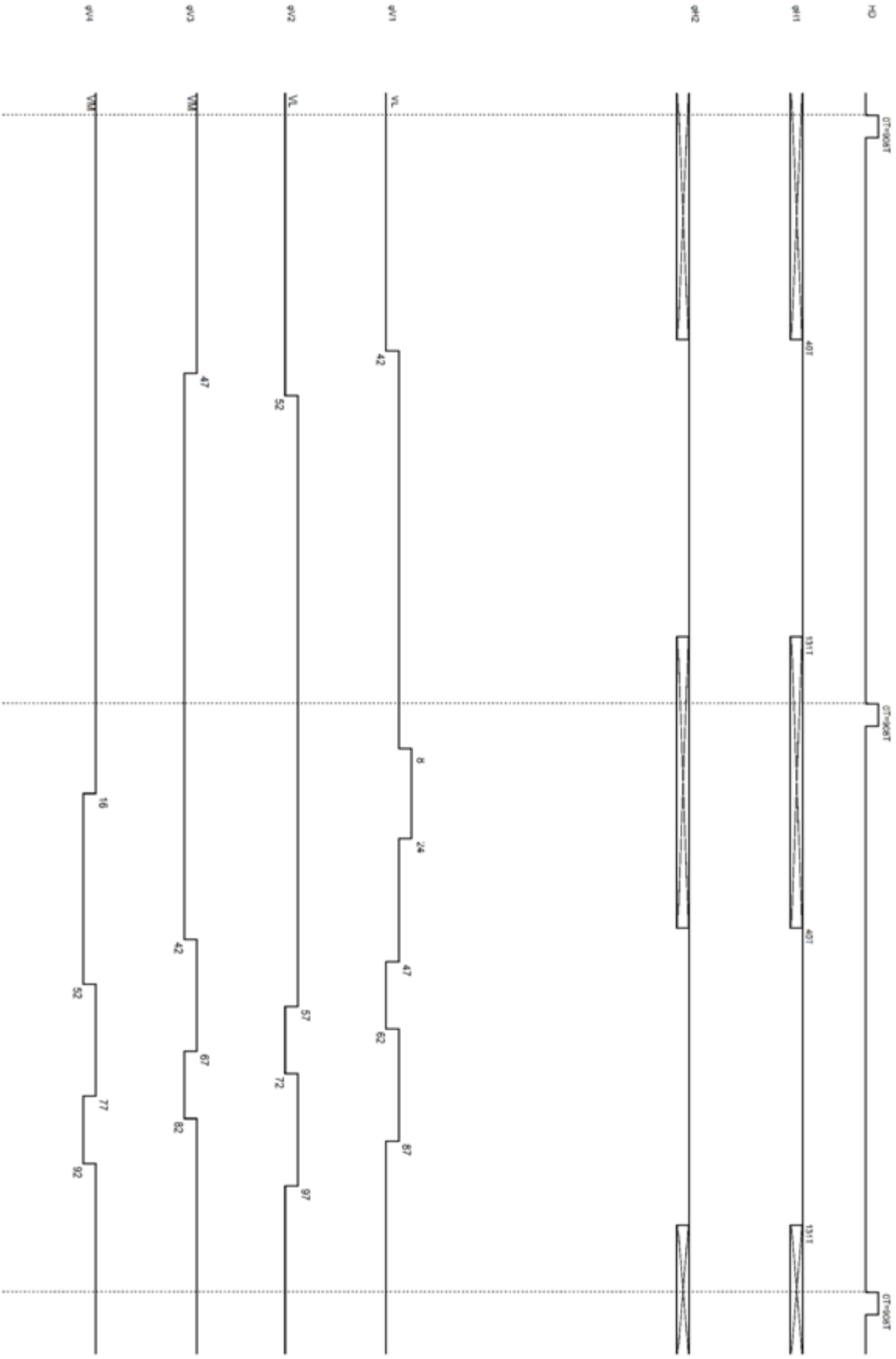

Slap width: 5T  
 $1T = 1/F_{ck} = 70.48ns$   
 Vertical transfer frequency: 354.7MHz  
 $(F_{ck} = 14.19MHz)$   
 Rev. 0.03

E2

Even Field

Read out timing

H-rate timing

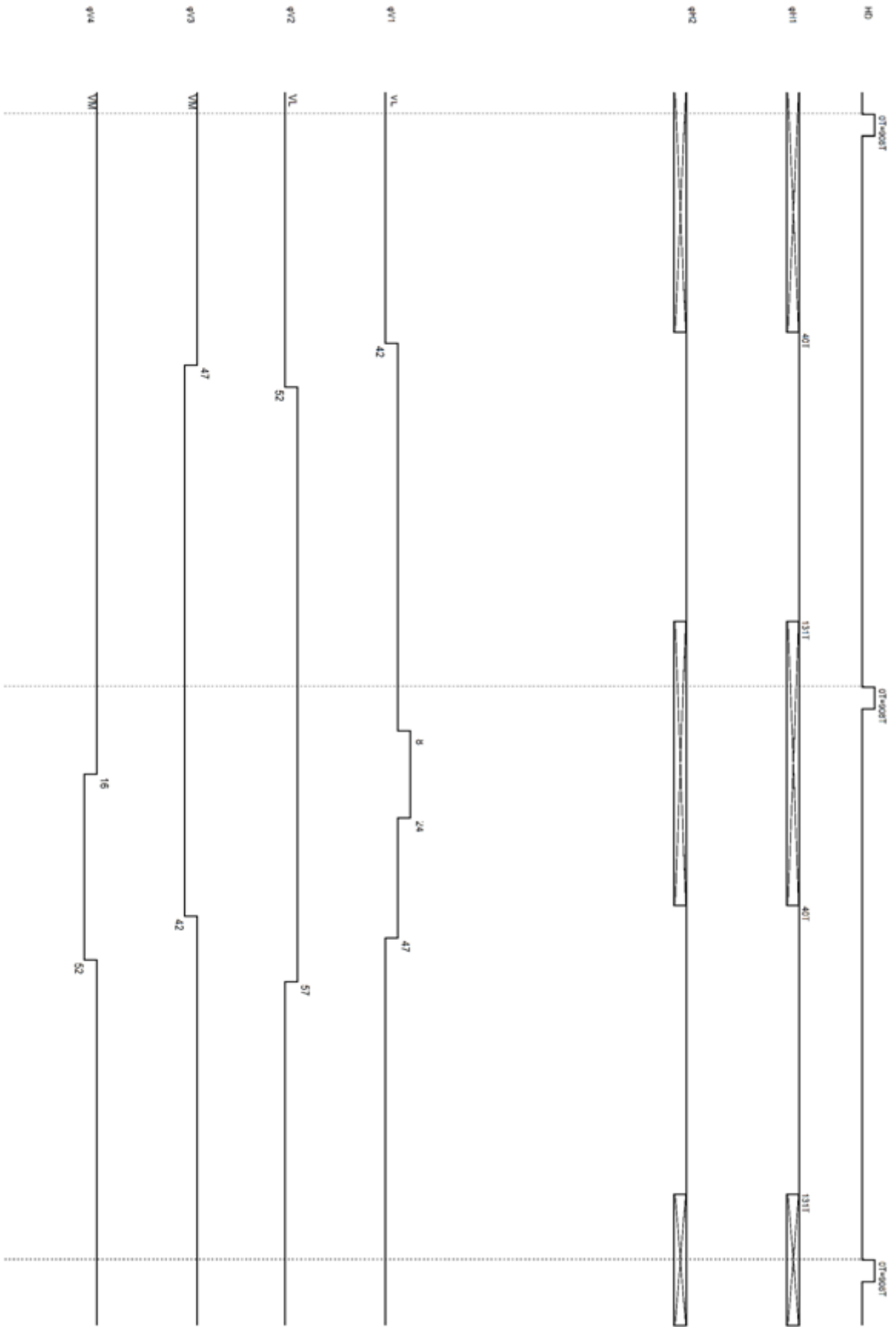

Step width: 5T  
 Vertical transfer frequency: 354.75Hz  
 1T=1/FCK = 70.48µs (FCK = 14.19MHz) Rev. 0.03

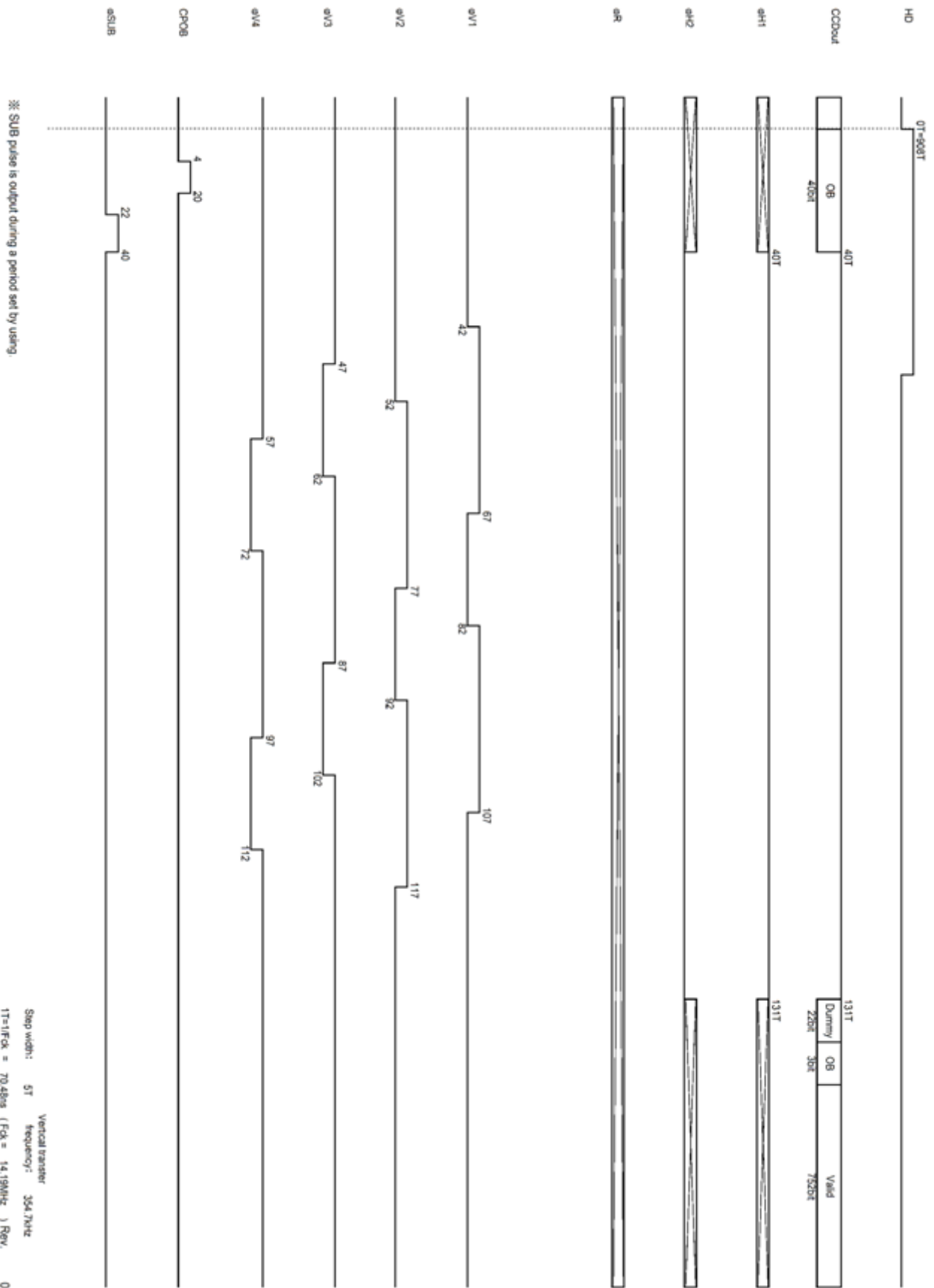

※ SUB pulse is output during a period set by using

Step width: 5T      Vertical transfer frequency: 354.7kHz  
 1T=11Fck = 70.48ns ( Fck = 14.15MHz ) Rev. 0.03



## 7. Notes on Device Handling

This section provides notes on handling CCD image sensors as optical devices implemented as a MOS integrated circuit ( IC ).

### 1) Cautions to Static Electricity

You should take extreme care to Static Electricity.

As a rule, device handling should be done in EPA ( EPA : ESD Protection Area (ESD : electrostatic discharge ) ).

If the static electricity discharges to the CCD's pins, transfer efficiency may be reduced and other characteristics changed depending on the voltage if the ESD.

In extreme cases, the protection circuits may break down and the device became inoperable.

- (1) In dry air, since a possibility that static electricity will occur by friction becomes high, please perform moisture control of the working space to more than 50 % RH
- (2) Use of dischargers, such as ionized air, can be effective in prompting the discharge of static electricity
- (3) Since static charge of several thousand volts can accumulate due to friction between the human body and synthetic fiber clothing, staff should always wear work clothes and uniforms made from antistatic materials. Also, staff should wear conductive footwear.
- (4) When handling CCD's, staff should use antistatic gloves and grounded, their bodies by wearing wrist strap connected to ground through 1MΩ resistance. Also, prevent static charges from accumulating by spreading grounded conductive sheets on the floors and workbenches where CCDs will be handled.
- (5) Please take extreme care to Static Electricity in your assemble process line involving products storing.

### 2) Notes on Power Supply Application

Although there is a list of points that require care and attention with respect to applying the power supply levels provided separately in the “ Note on Power supply Application” document, the conditions listed below must also be met

- (1) Do not use this device with any of the maximum ratings stipulated in the device standard exceeded.
- (2) Do not apply power with the CCD pins connected incorrectly. That could result in source/drain reversals or the protection transistors being forward biased and large currents could destroy the inter connects on the chip.
- (3) Do not use a power supply whose transient voltage levels exceed the maximum rating.
- (4) Use the “Recommended Sample Circuit ( Latch – up prevention peripheral circuit example )” to prevent latch – up from occurring. If latch – up does occur, abnormal currents may flow between power supply terminal and GND. The heat generated may make the CCD inoperative

### 3) Notes on Temperature in Assembly Process and Soldering

CCD has the limit temperature as follows, based on the physical limit of materials used.

Please take care not to hearten over this temperature in your process.

Item	Limit temperature	Possible damage ( due to higher temperature than the limit )
CCD part	≤ 170 °C	Degradation of on-chip filter and lens

4) Notes on CCDs as Optical Elements

(1) This CCD features micro lenses that increase the ability of the photodiodes to collect light and color filter that allow the CCD to recognize color information integrated on the chip itself in the sections of the CCD that perform the photoelectrical conversion.

Since these on-chip components are implemented using plastics, the transparency of the filter and lens materials is reduced by the light that enters the CCD depending on the spectral characteristics, intensity, and exposure time.

Due to this fact, these devices must be protected from UV light, sunlight, and any other bright light during all phases of use and handling, including storage, transport and end product manufacture.

(2) If the same pattern is protected onto the CCD image sensor for an extended period, depending on the intensity of the image and the time, that pattern may be burned onto the sensor resulting in the pattern being reflected in the characteristic or variations in characteristic, regardless of whether or not power is applied.

When not using a CCD, we recommend blocking all light and turning off the power.

5) storage environment

CCD is a precision optical product.

Therefore, temperature, humidity, radiation and static electricity etc. of storage environment have to be controlled.

Please pay attention to the following when storing CCD.

(1) Storage condition of CCD

a) Packed Condition.

Please storage CCD as it packed on our delivery packing in the following environment.

- Temperature :  $T_a = 25 \pm 10 \text{ }^\circ\text{C}$
- Humidity : RH = 60 % or less
- Storage life : 1 year

b) Opened pack condition

When you opened pack, please keep environment as follows.

- Temperature :  $T_a = 23 \pm 5 \text{ }^\circ\text{C}$
- Humidity : RH = 10 % or less
- Storage life : 3 months

If you can not store CCD in dry air, please keep environment as follows.

- Temperature :  $T_a = 23 \pm 5 \text{ }^\circ\text{C}$
- Humidity : RH = 30 ~ 60 %
- Storage life : 3 months

But, the condition should fulfill the following equation.

$$RH < -3x Ts + 114 \text{ ( Red area in Fig.1 )}$$

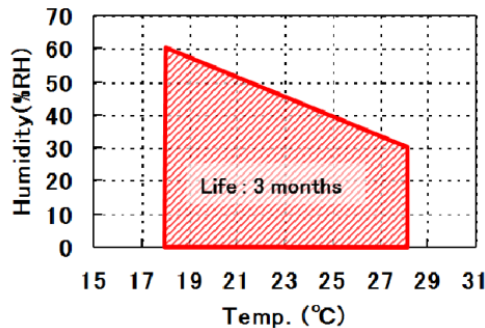

**Fig.1 Storage life after opening aluminum pack**

(2) Other Cautions

- a) Do not store CCD in a location where they will be irradiated sunlight, UV and so on.
- b) Do not subject these devices to rapid change in temperature that could cause condensation.
- c) Do not subject these devices to ionizing radiation, electrostatic fields or discharge, or strong magnetic fields.
- d) If the storage location is humidified with a humidifier in the winter, use water that has been brought to a boil.  
this is because chlorine and other chemicals dissolved in the water could cause oxidation of the leads.
- e) Store packing containers in a place where they will not be subject to vibration, mechanical shock, or being stacked under other materials or freight.

6) Dust and Contamination

Dust or contamination on the glass surface could deteriorate the output characteristic or cause a scar. In order to minimize dust or contamination on the glass surface, take the following precautions :

(1) Handle CCD in a clean environment such as a cleaned booth.

Perform all lens assembly and work in a clean room.

(2) Do not touch the glass surface with the finger. If dust or contamination gets on the glass surface, the following cleaning method is recommended:

- Dust from static electricity should be blown off with an ionized air blower. For anti electrostatic measure, however, ground all the leads on device before blowing off the dust.
- The contamination on the glass surface should be wiped off with a clean applicator soaked in isopropyl alcohol. Wipe slowly and gently in one direction only.

Frequently replace the applicator and do not use the same applicator to clean more than one device

## 8. Package

### 8.1 Package Dimension (16 PIN PLASTIC-DIP)

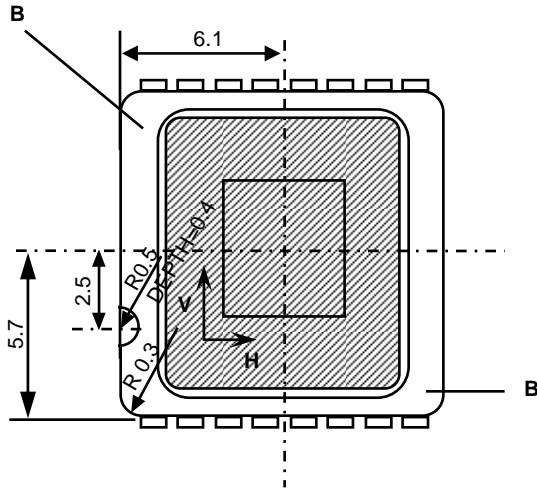

UNIT = mm

1. The center of the effective image area relative to " B " and " B' "is  $(H, V) = (6.1, 5.7) \pm 0.15\text{mm}$ .
2. The rotation angle of the effective image area relative to H and V is  $\pm 1.5^\circ$ .

 : GLASS LID

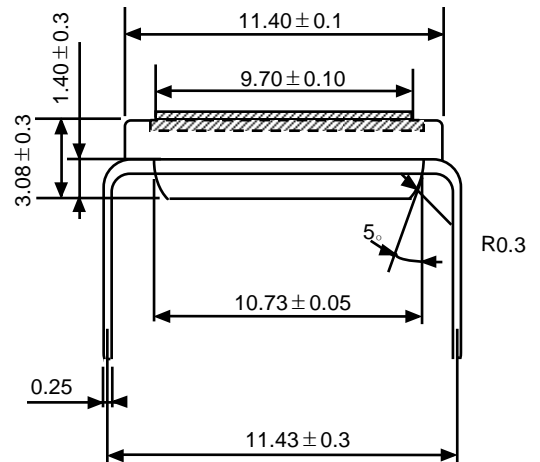
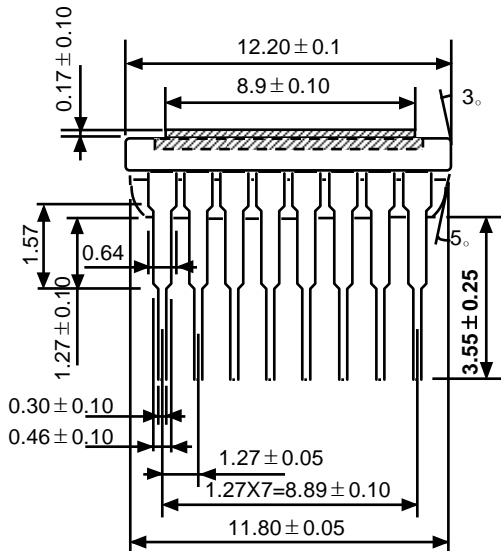



## 8.2 Package Marking

### 8.2.1. Marking contents

- (1) Product name : Ai339
- (2) Company name : A1 PROs
- (3) Country of origin : KOREA
- (4) Data code :

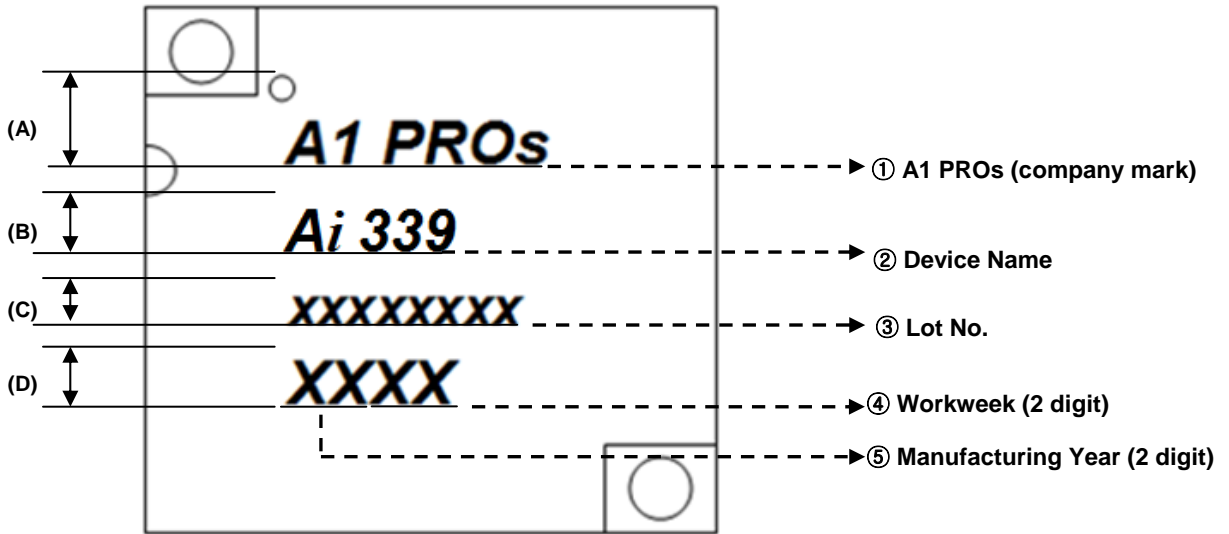

**Marking : FONT120P**

**Character Height (mm) : (A):2.00, (B):1.500, (C):0.700, (D):1.350**

**Character width (mm): (A):5.933, (B):6.822**

**Line Space (mm): 0.35, 0.45, 0.64**

**Accuracy : ±5%**