

# Schottky Barrier Diodes 90V

Parameter Type No.	Absolute Maximum Ratings					Electrical Characteristics (Ta = 25°C)					Others		
	VRM (V)	IF(AV) (A)	IFSM (A) 50Hz Half-cycle Sinewave Single Shot	TJ (°C)	Tstg (°C)	VF (V) max	IR (mA)	IR (H) (mA) VR = VRM max Ta = 100°C max	trr (ns)	IF/IRP (mA)	Rth(j-ℓ) (°C/W)	Mass (g)	Fig.
AK 09	90	0.7	10	-40 to +150	0.81	0.7	1.0	5	100	100/100	22.0	0.13	Ⓐ
EK 09													20.0
EK 19		1.5	40			15.0	0.45	Ⓒ					
RK 19								17.0			0.6	Ⓓ	
RK 39		2.0	50			12.0	0.6	Ⓔ					
RK 49		3.5	60			8.0	1.2	Ⓕ					

## AK 09

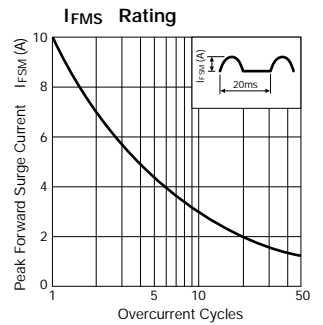
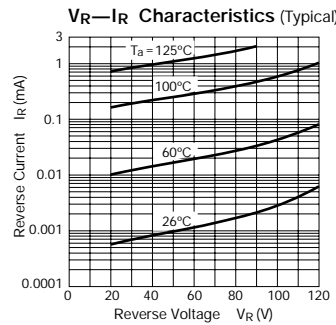
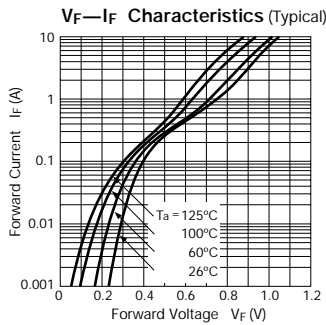
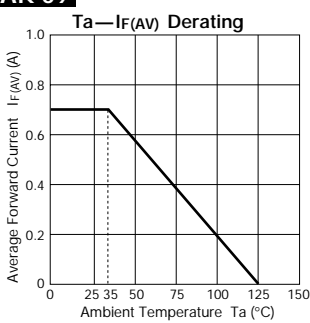

## EK 09

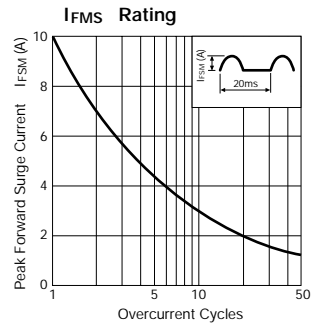
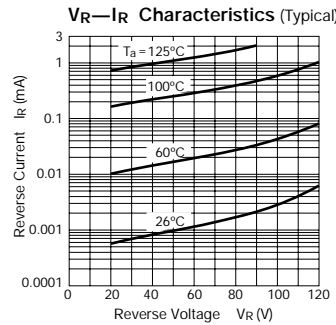
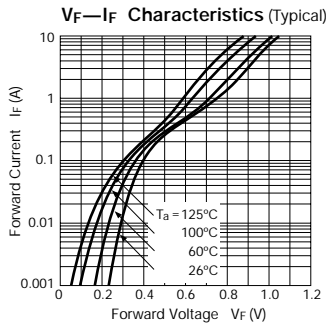
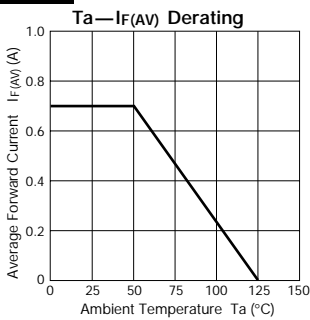

## EK 19

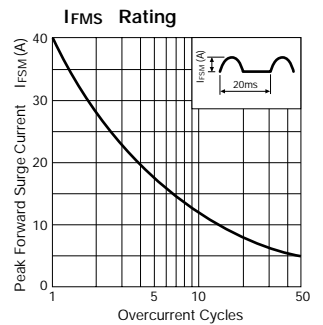
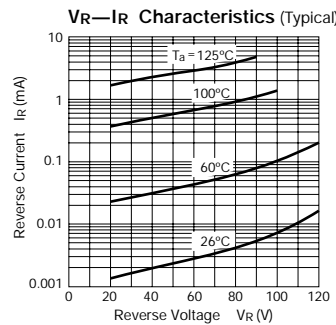
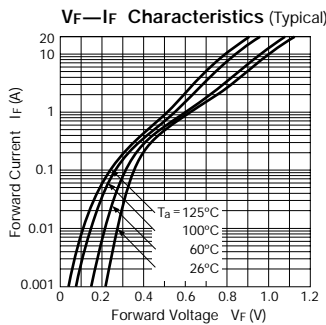
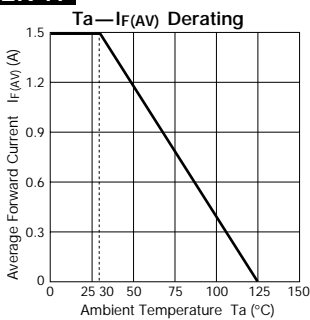

## External Dimensions (Unit: mm)

Flammability:  
UL94V-0 or Equivalent

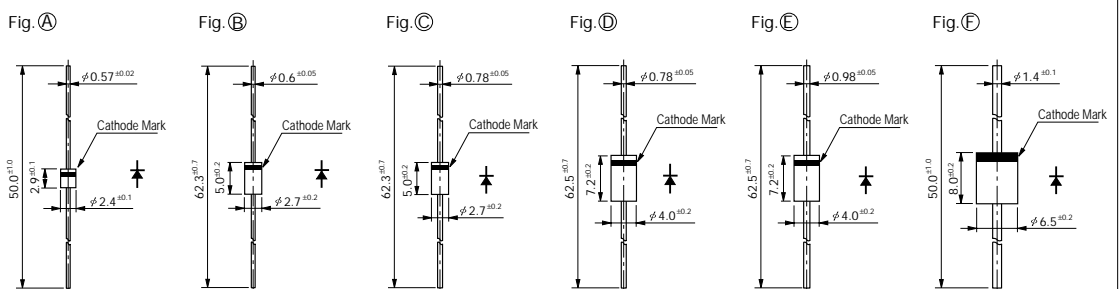

**RK 19**

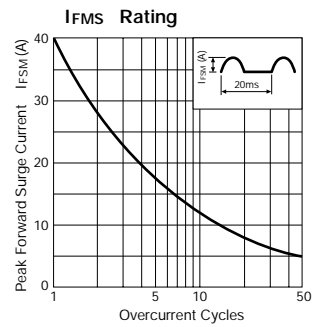
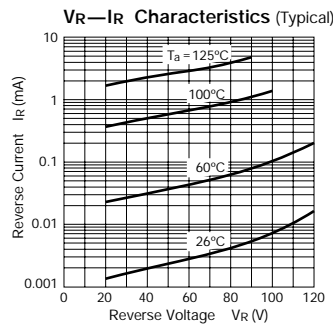
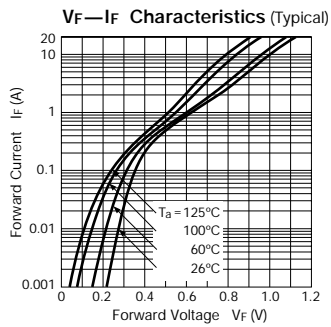
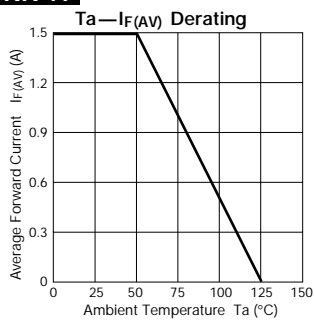

**RK 39**

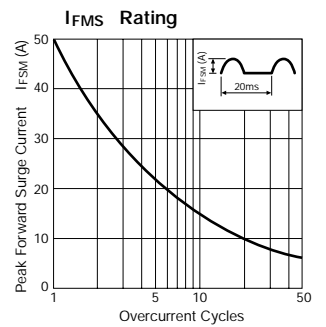
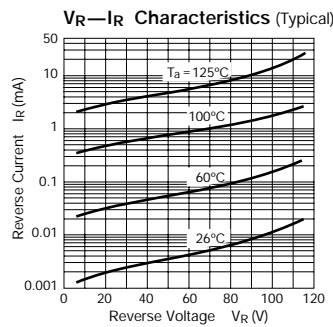
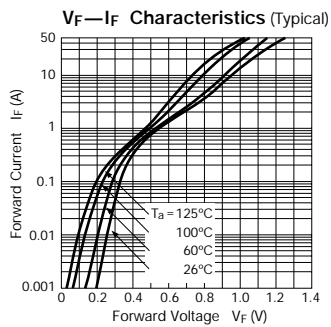
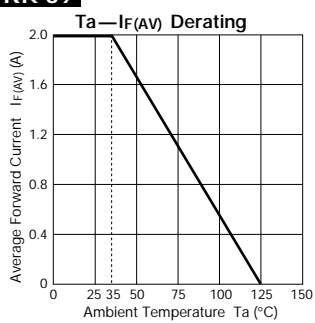

**RK 49**

