



AKD5386-B

AK5386 Evaluation Board Rev.0

GENERAL DESCRIPTION

AKD5386-B is an evaluation board for the digital audio 24bit 192kHz A/D converter, AK5386. AKD5386-B has analog input circuits and a digital interface transmitter, and can achieve the interface with digital audio systems via opt-connector.

■ **Ordering guide**

AKD5386-B --- AK5386 Evaluation Board

FUNCTION

- **DIT (AK4114) with optical output**

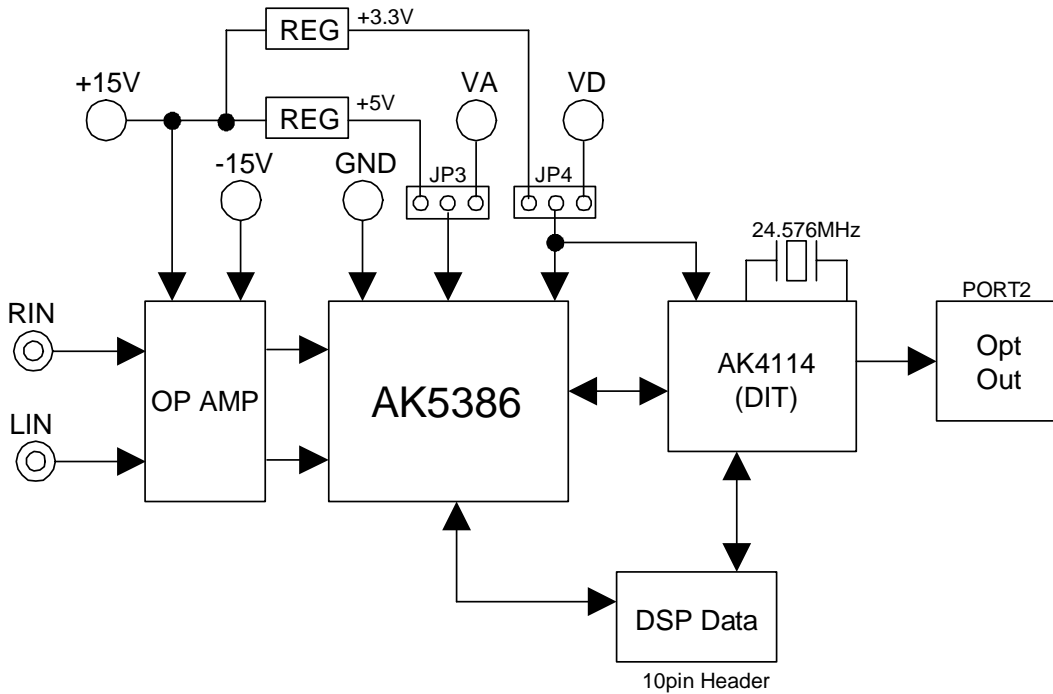

Figure 1 AKD5386-B Block Diagram

* Circuit diagram and PCB layout are attached at the end of this manual.

Operation Manual

■ Operation sequence

1) Set up the power supply lines.

Name of connector	Color of connector	Voltage	Used for	Comment and attention	Default Setting
+15V	Green	+10~15V	NJM4580 Regulator T1 Regulator T2	This connector should be connected. And this connector is used when VA and VD of AK5386 is supplied from regulator T1 and T2. In this case, JP3 and JP4 should be REG side. When this is REG side, VA and VD connector should be open. (Default)	+15V
-15V	Blue	-10~-15V	NJM4580	This connector should be connected.	-15V
VA	Red	+4.5~+5.5V	VA of AK5386	This connector is used when VA of AK5386 is supplied from VA connector without regulator T1. In this case, JP3 should be VA side.	Open
VD	Red	+2.7~+3.6V	VD of AK5386 AK4114 74HC14	This connector is used when VD of AK5386 is supplied from VD connector without regulator T2. In this case, JP4 should be VD side.	Open
AGND	Black	0V	Analog Ground	This connector should be connected.	0V
DGND	Black	0V	Digital Ground	This connector is used when DGND is supplied besides AGND. In this case, JP8 should be open.	Open

Table 1. Power supply lines

(Note) Each supply line should be distributed from the power supply unit.

2) Set up the evaluation mode, jumper pins and DIP switches. (See the followings.)

3) Power on.

The AK5386 and AK4114 should be reset once bringing SW2 = "L" upon power-up.

■ Evaluation mode

(1) Slave Mode

(1-1) A/D evaluation using DIT function of AK4114 <Default>

PORT2 (DIT) is used. DIT generates audio bi-phase signal from received data and which is output through optical connector (TOTX141). It is possible to connect AKM's D/A converter evaluation boards on the digital-amplifier, which equips DIR input. Nothing should be connected to PORT1 (DSP).

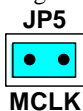

(1-2) All interface signals including master clock are fed externally.

PORT1 (DSP) is used. All interface signals (MCLK, SCLK, LRCK) are provided to the AK5386 through PORT1. JP5 (MCLK) should be open. The DIF1 of SW1 (MODE) should be set to "H".

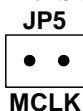

■ Other jumper pins set up

1. JP2 (CKS1) : Setting of CKS1 pin for AK5386
Please refer to the setting of the AK5386 mode of page 4 Table 3.
H : CKS1="H"
L : CKS1="L" <Default>
2. JP3 (VA) : Select VA pin for AK5386
VA : Supply from VA connector.
REG : Supply from regulator. In this case, VA connector should be open. <Default>
3. JP4 (VD) : Select VD pin for AK5386
VD : Supply from VD connector.
REG : Supply from regulator. In this case, VD connector should be open. <Default>
4. JP5 (MCLK) : Select master clock of the AK5386.
SHORT: AK4114 supplies MCLK. <Default>
OPEN : PORT1 supplies MCLK.
5. JP6 (TX) : Select TX
OPT : Optical Connector (PORT2) is used. <Default>
BNC : BNC (J3) is used.
6. JP7 (AGND) : Analog ground 1 and Analog ground 2
SHORT: Common. <Default>
OPEN : Separated.
7. JP8 (GND) : Analog ground 1 and Digital ground
SHORT: Common. (The DGND connector can be open.) <Default>
OPEN : Separated. In this case, DGND connector should be 0V.

■ DIP Switch set up

[SW1] (MODE): Setting the evaluation mode for AK5386 and AK4114
ON is “H”, OFF is “L”. CKS1 should be set by JP2.

No.	Name	OFF (“L”)	ON (“H”)	Default
1	CKS0	See Table 3		L
2	CKS2			L
3	DIF0	MSB justified	I ² S Compatible	L
4	DIF1	AK4114 Master mode	AK4114 Slave mode	L
5	OCKS0	See Table 4		H
6	OCKS1			L

Table 2. Mode Setting

CKS2	CKS1	CKS0	HPF	Master/Slave	MCLK	SCLK
L	L	L	ON	Slave	128/192fs (Quad Speed) 256/384fs (Double Speed) 512/768fs (Normal Speed)	≥ 48fs or 32fs
L	L	H	OFF	Slave	128/192fs (Quad Speed) 256/384fs (Double Speed) 512/768fs (Normal Speed)	≥ 48fs or 32fs
L	H	L	ON	Master	256fs (Double Speed)	64fs
L	H	H	ON	Master	512fs (Normal Speed)	64fs
H	L	L	ON	Master	128fs (Quad Speed)	64fs
H	L	H	ON	Master	192fs (Quad Speed)	64fs
H	H	L	ON	Master	384fs (Double Speed)	64fs
H	H	H	ON	Master	768fs (Normal Speed)	64fs

Table 3. Mode Setting of AK5386

OCKS1	OCKS0	X'tal	fs (max)
0	0	256fs	96 kHz
0	1	256fs	96 kHz
1	0	512fs	48 kHz
1	1	128fs	192 kHz

Table 4. MCLK Frequency Setting of AK4114

Note: AK4114 does not support MCLK=192fs/384fs/768fs.
PORT1 (DSP) should be used when MCLK=192fs/384fs/768fs.

■ The function of the toggle SW

Upper-side is “H” and lower-side is “L”.

[SW2] (PDN): Resets of AK5386 and AK4114. Keep “H” during normal operation.
AK5386 and AK4114 is reset by making SW1(PD) "L" once at the time of the power-up.
Afterwards, please make SW1(PD) "H".

■ Analog Input Circuits

Analog signal is input via J1(RIN) and J2(LIN) of RCA connectors.

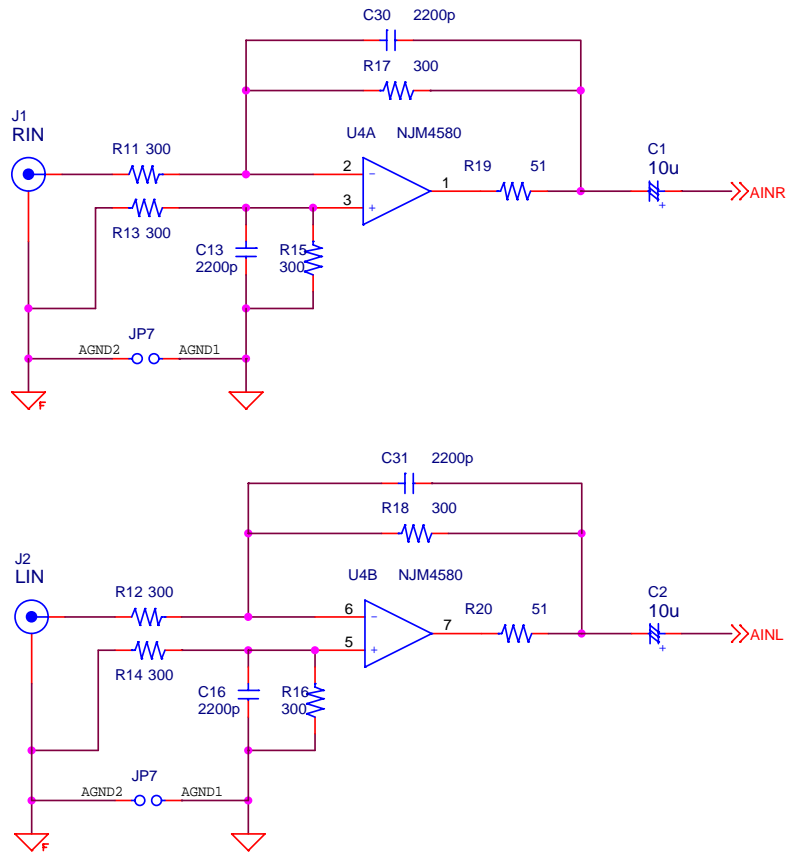

Figure 2 Analog Input circuits

* AKM assumes no responsibility for the trouble when using the circuit examples.

MEASUREMENT RESULTS

[Measurement condition]

- Measurement unit : Audio Precision, System Two Cascade
- MCLK : 512fs (Normal Speed) , 256fs (Double Speed) , 128fs (Quad Speed)
- SCLK : 64fs
- fs : 48kHz, 96kHz, 192kHz
- Bit : 24bit
- Measurement Frequency : Normal Speed 20Hz ~ 20kH , Double & Quad Speed 20Hz ~ 40kHz
- Input Frequency : 1kHz
- Power Supply : VA = 5.0V , VD = 3.3V (Using regulator)
- Interface : DIT
- Temperature : Room

[Measurement results]

Parameter				Result (Lch / Rch)	Unit
ADC Analog Input Characteristics:					
S/(N+D) (-1dB Input)	fs=48kHz	20kHz LPF	-	96.8 / 98.4	dB
	fs=96kHz	40kHz LPF	-	96.2 / 98.3	
	fs=192kHz	40kHz LPF	-	95.8 / 97.6	
D-Range (-60dB Input)	fs=48kHz	20kHz LPF	A-weighted	108.4 / 109.0	dB
			-	45.6 / 46.5	
	fs=96kHz	40kHz LPF	A-weighted	108.6 / 109.3	
			-	43.5 / 44.1	
	fs=192kHz	40kHz LPF	A-weighted	108.1 / 108.5	
			-	43.0 / 43.4	
S/N	fs=48kHz	20kHz LPF	A-weighted	108.6 / 109.3	dB
			-	105.9 / 107.0	
	fs=96kHz	40kHz LPF	A-weighted	108.7 / 109.3	
			-	103.6 / 104.1	
	fs=192kHz	40kHz LPF	A-weighted	108.1 / 108.4	
			-	103.2 / 103.3	

[Plots]

fs=48kHz

AKM

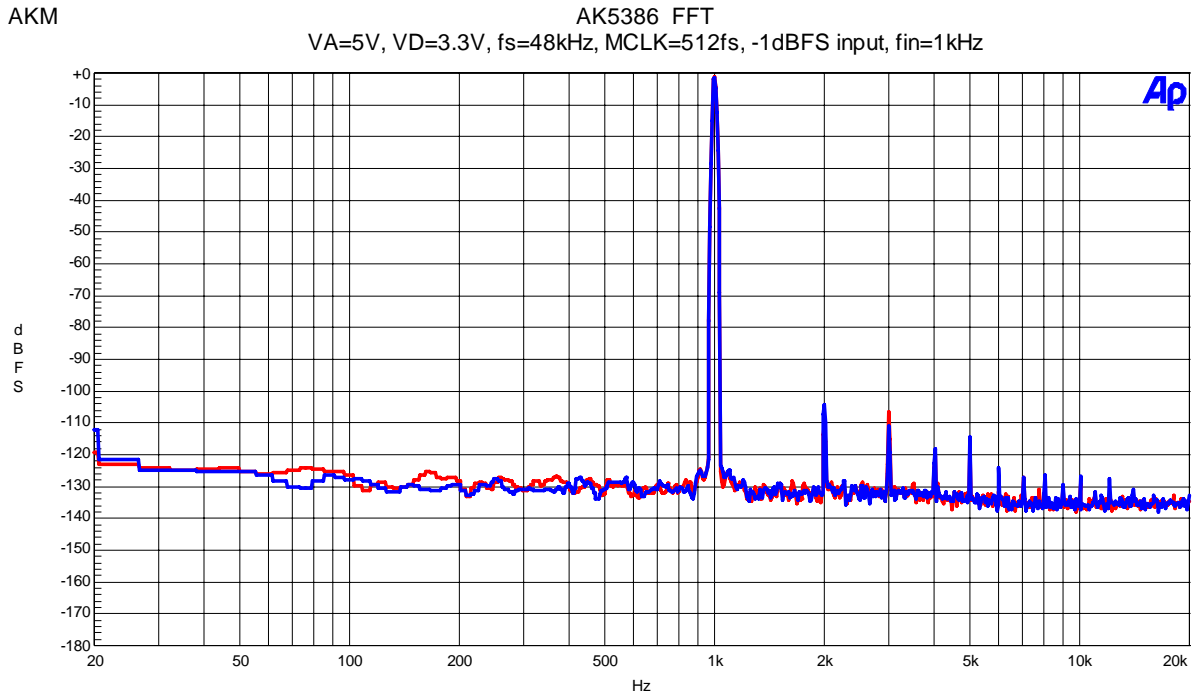

Figure 3 FFT (1kHz, -1dB input)

AKM

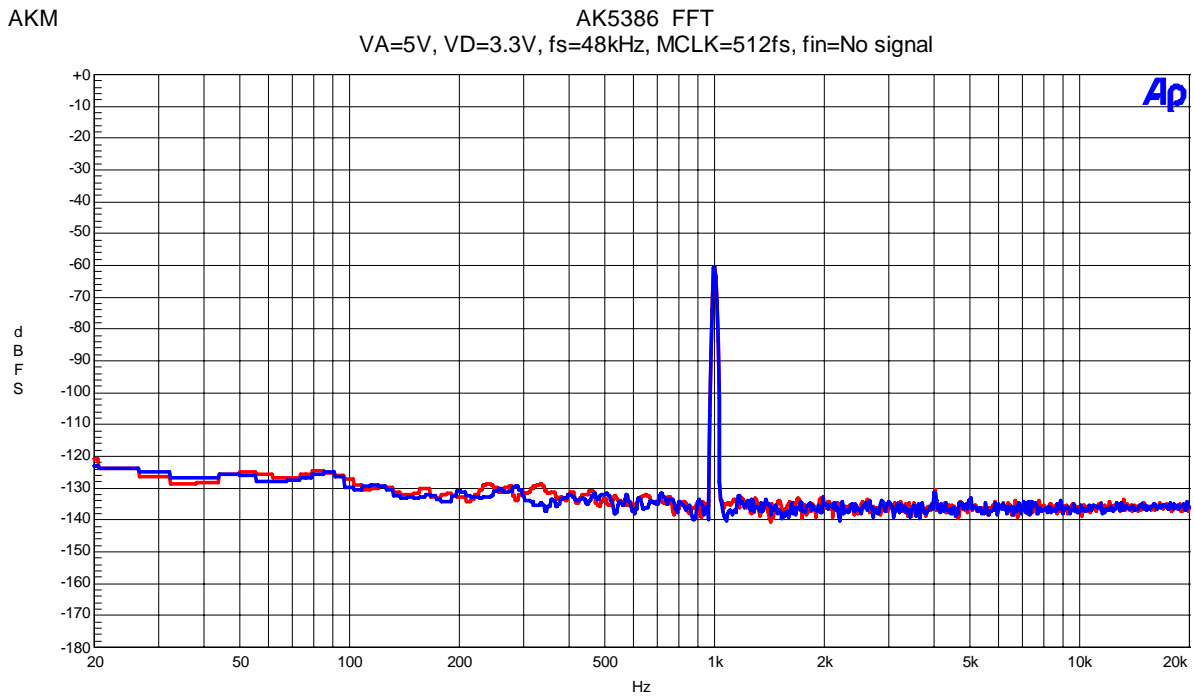

Figure 4 FFT (1kHz, -60dB input)

AKM

AK5386 FFT
VA=5V, VD=3.3V, fs=48kHz, MCLK=512fs, fin=No signal

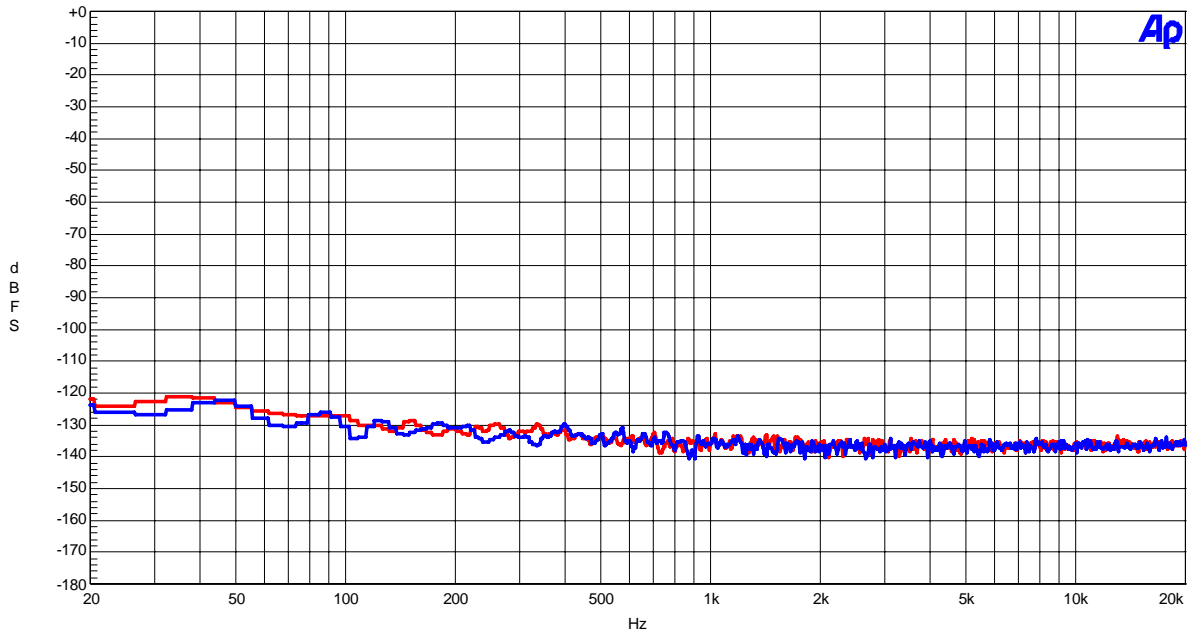

Figure 5 FFT (off the input)

AKM

AK5386 THD+N vs. Input Level
VA=5V, VD=3.3V, fs=48kHz, MCLK=512fs, fin=1kHz

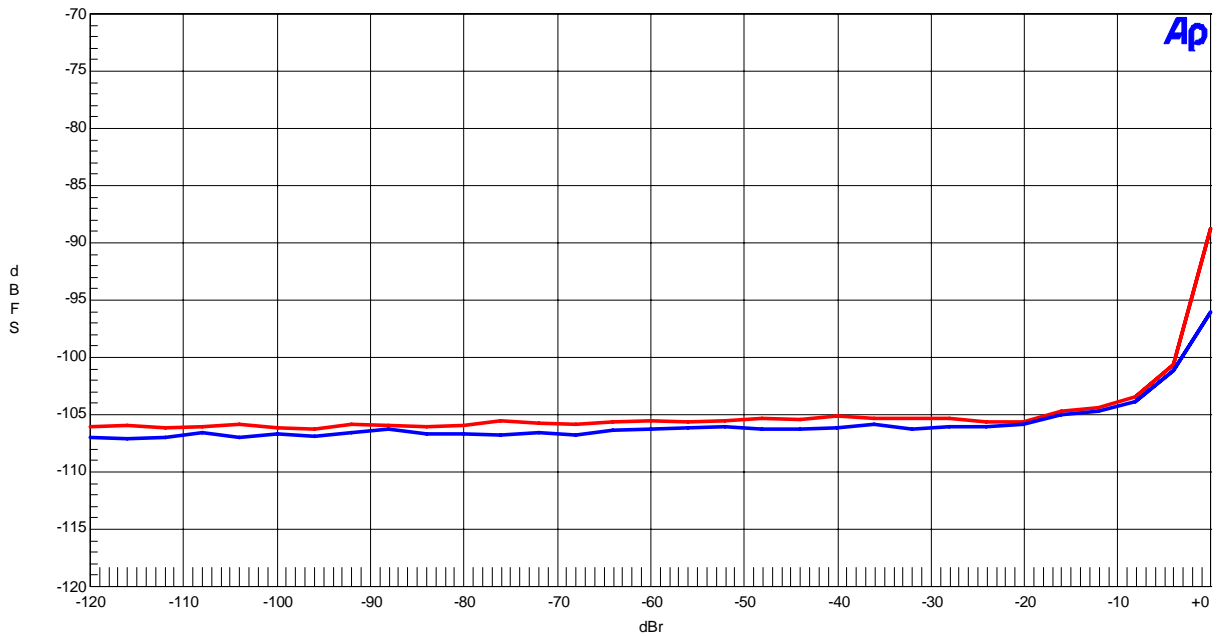

Figure 6 THD+N vs Input Level (1kHz input)

AKM

AK5386 THD+N vs. Input Frequency
VA=5V, VD=3.3V, fs=48kHz, MCLK=512fs, -1dBFS input

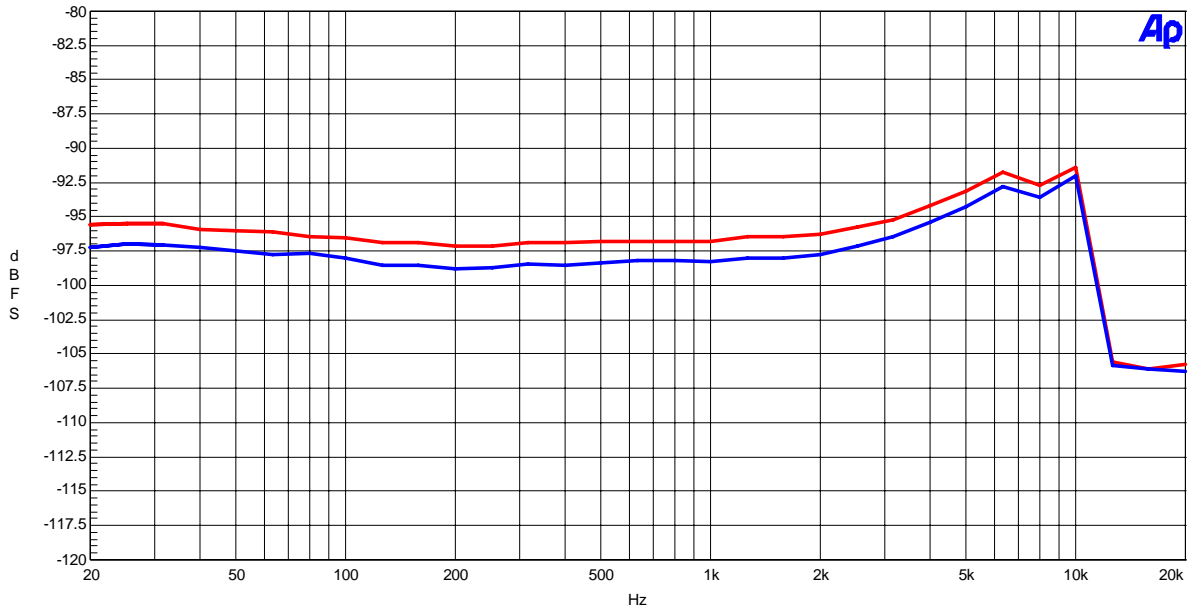

Figure 7 THD+N vs Input Frequency (-1dB input)

AKM

AK5386 Linearity
VA=5V, VD=3.3V, fs=48kHz, MCLK=512fs, fin=1kHz

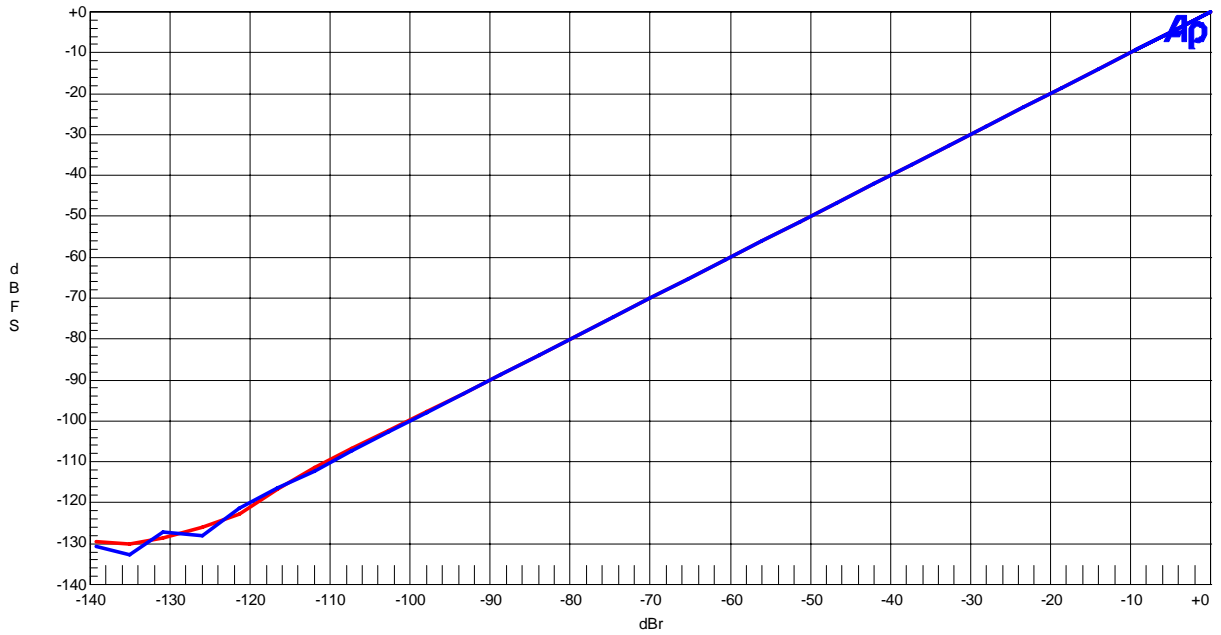

Figure 8 Linearity (fin=1kHz)

AKM

AK5386 Frequency Response
VA=5V, VD=3.3V, fs=48kHz, MCLK=512fs, -1dBFS input

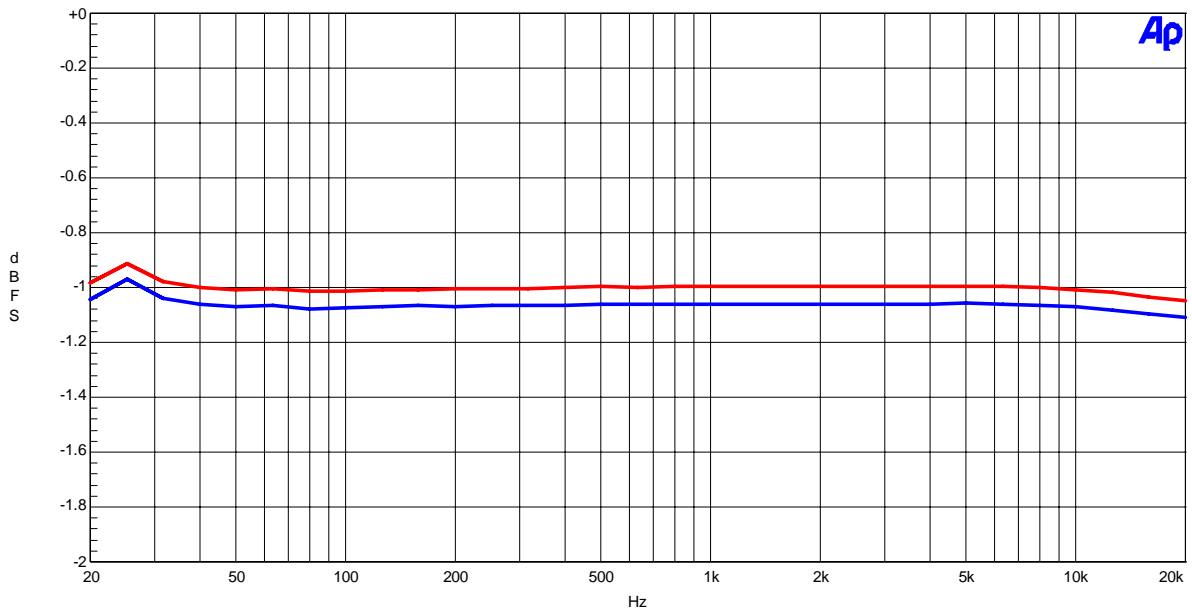

Figure 9 Frequency Response (-1dB input)

AKM

AK5386 Crosstalk (Red=Lch, Blue=Rch)
VA=5V, VD=3.3V, fs=48kHz, MCLK=512fs, -1dBFS input

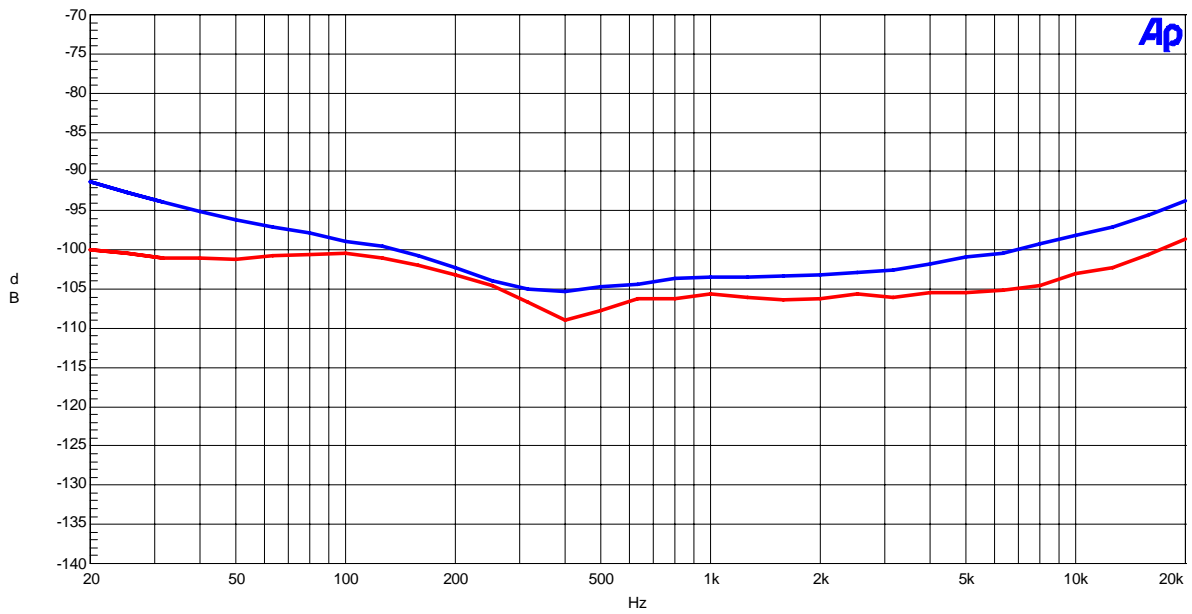

Figure 10 Cross-talk (-1dB input)

fs=96kHz

AKM

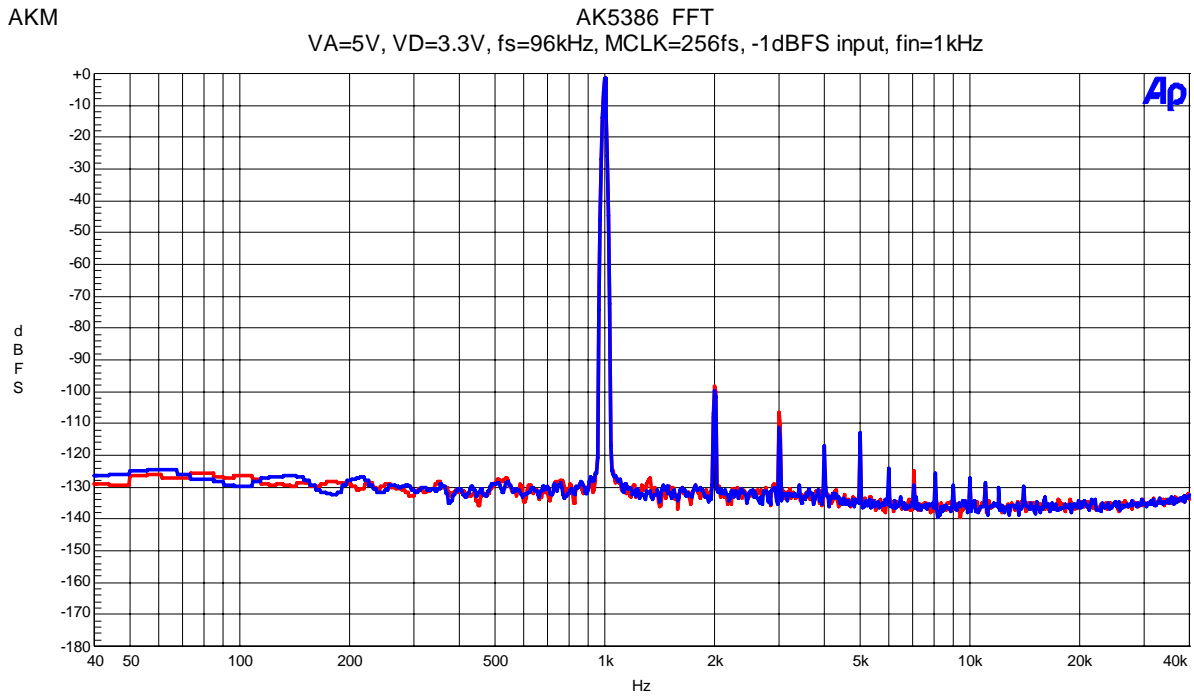

Figure 11 FFT (1kHz, -1dB input)

AKM

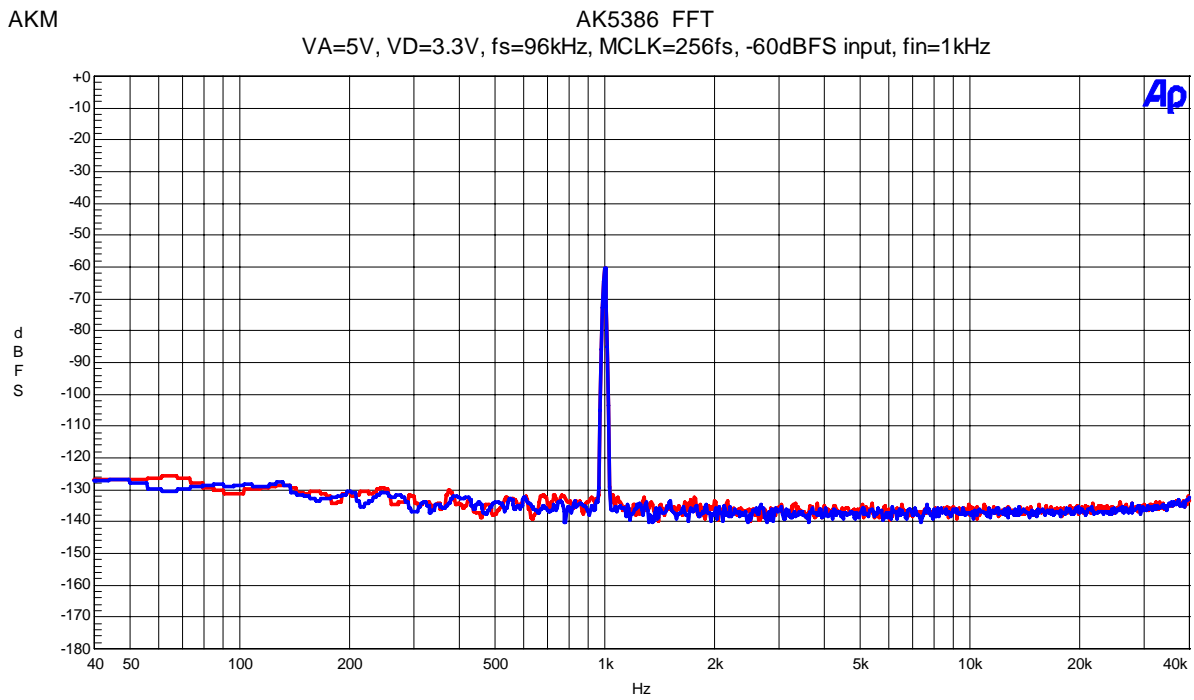

Figure 12 FFT (1kHz, -60dB input)

AKM

AK5386 FFT
VA=5V, VD=3.3V, fs=96kHz, MCLK=256fs, fin=No signal

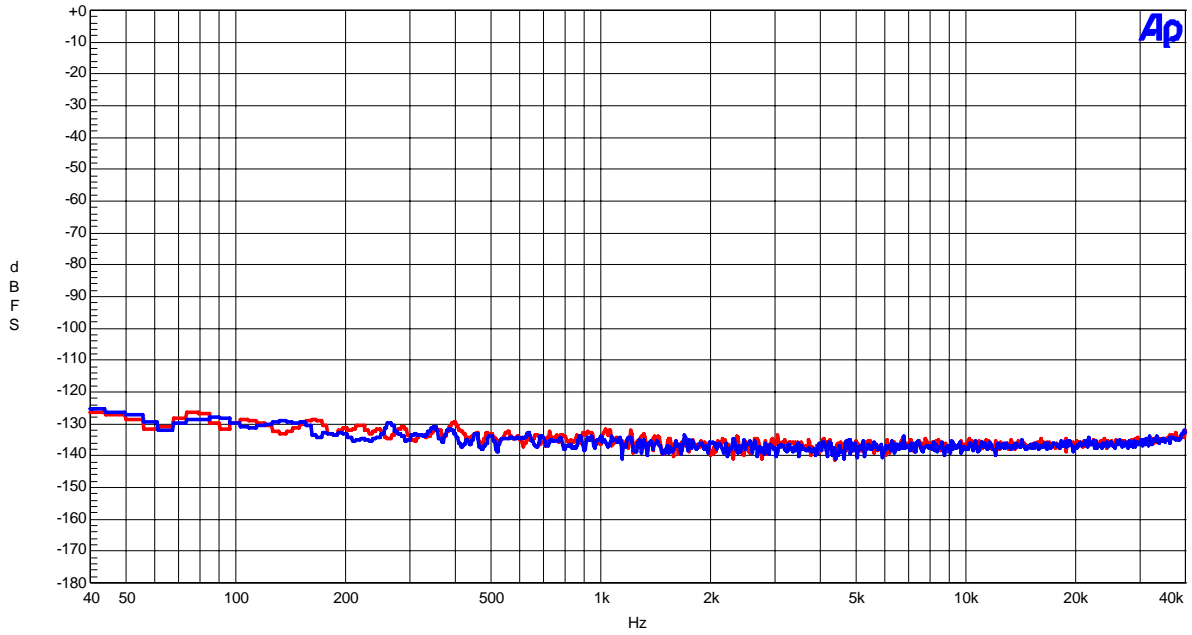

Figure 13 FFT (off the input)

AKM

AK5386 THD+N vs. Input Level
VA=5V, VD=3.3V, fs=96kHz, MCLK=256fs, fin=1kHz

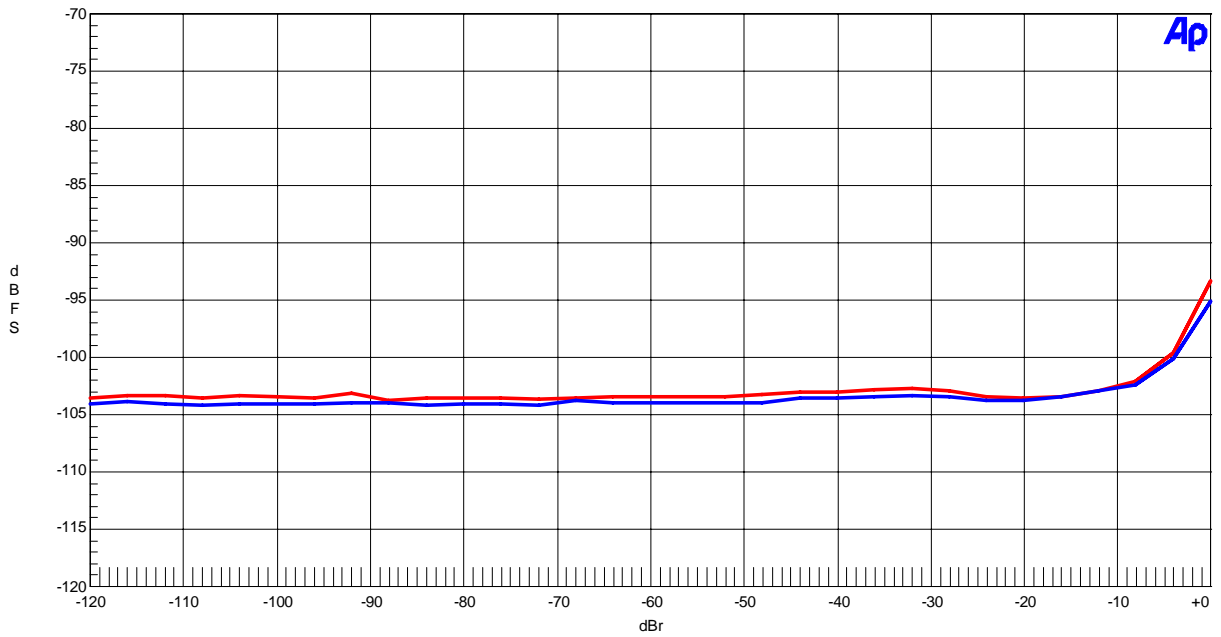

Figure 14 THD+N vs Input Level (1kHz input)

AKM

AK5386 THD+N vs. Input Frequency
 VA=5V, VD=3.3V, fs=96kHz, MCLK=256fs, -1dBFS input

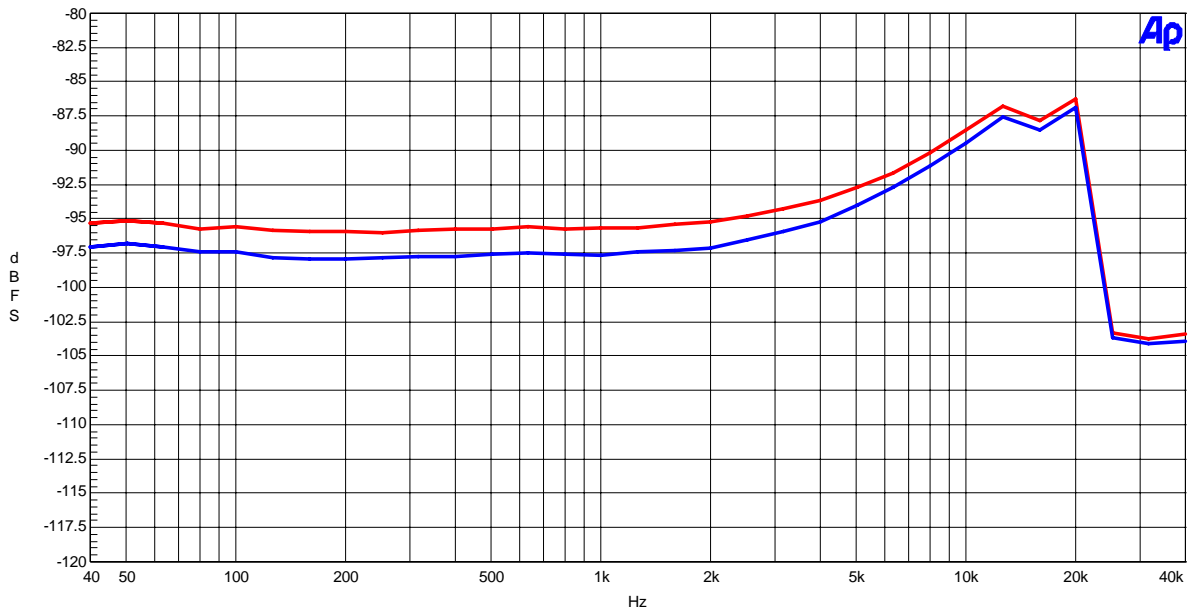

Figure 15 THD+N vs Input Frequency (-1dB input)

AKM

AK5386 Linearity
 VA=5V, VD=3.3V, fs=96kHz, MCLK=256fs, fin=1kHz

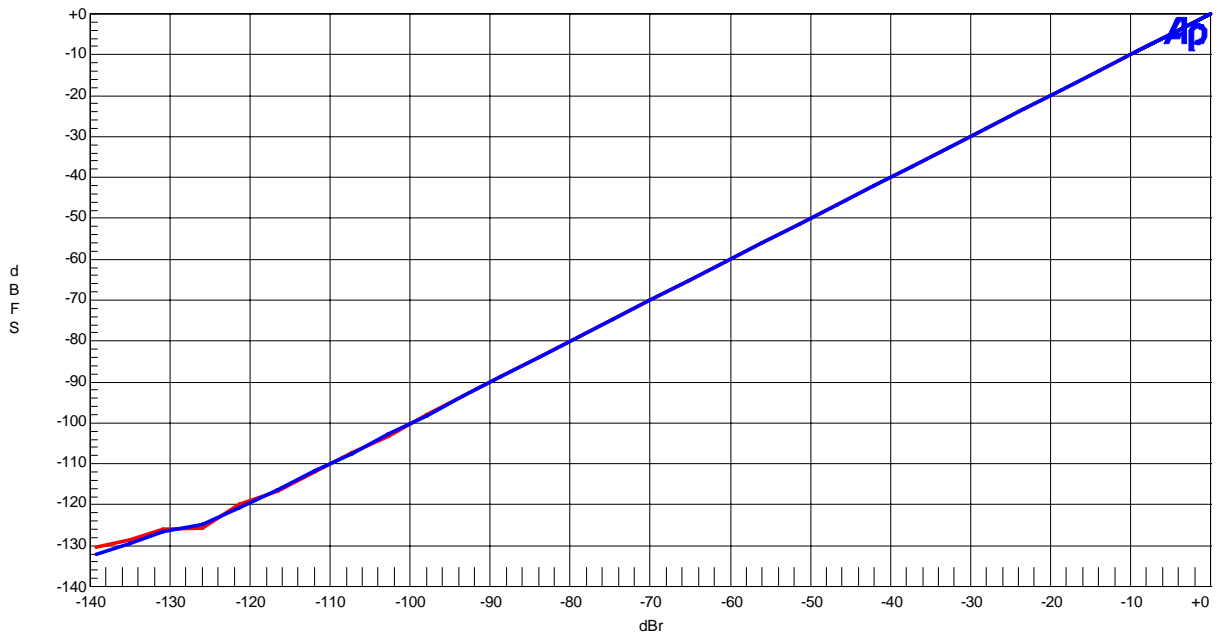

Figure 16 Linearity (fin=1kHz)

AKM

AK5386 Frequency Response
VA=5V, VD=3.3V, fs=96kHz, MCLK=256fs, -1dBFS input

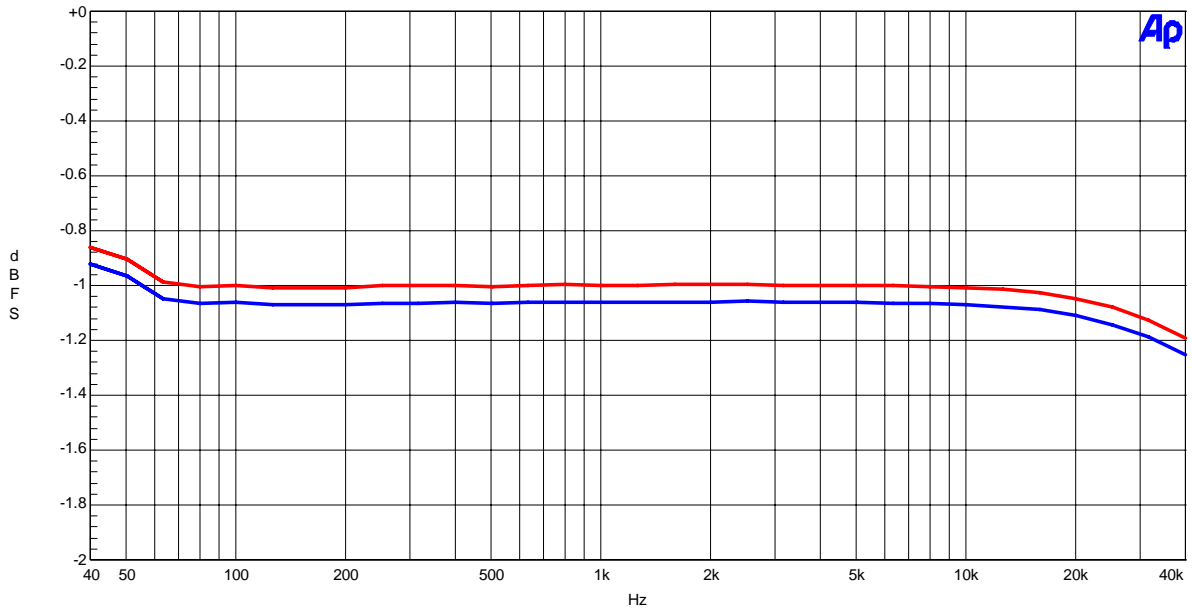

Figure 17 Frequency Response (-1dB input)

AKM

AK5386 Crosstalk (Red=Lch, Blue=Rch)
VA=5V, VD=3.3V, fs=96kHz, MCLK=256fs, -1dBFS input

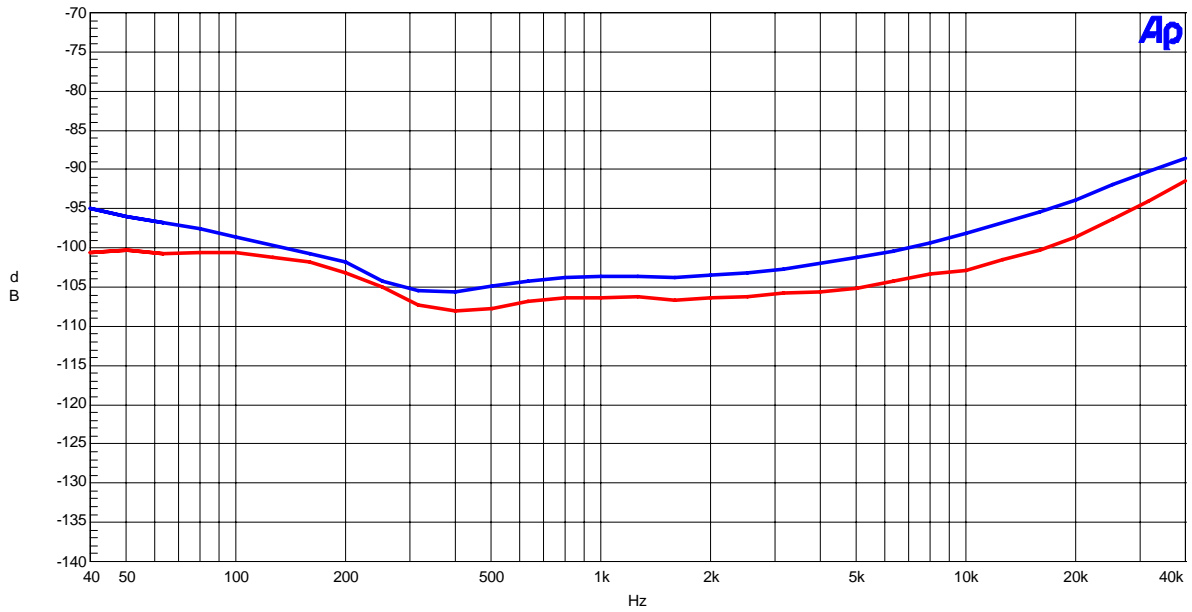

Figure 18 Cross-talk (-1dB input)

fs=192kHz

AKM

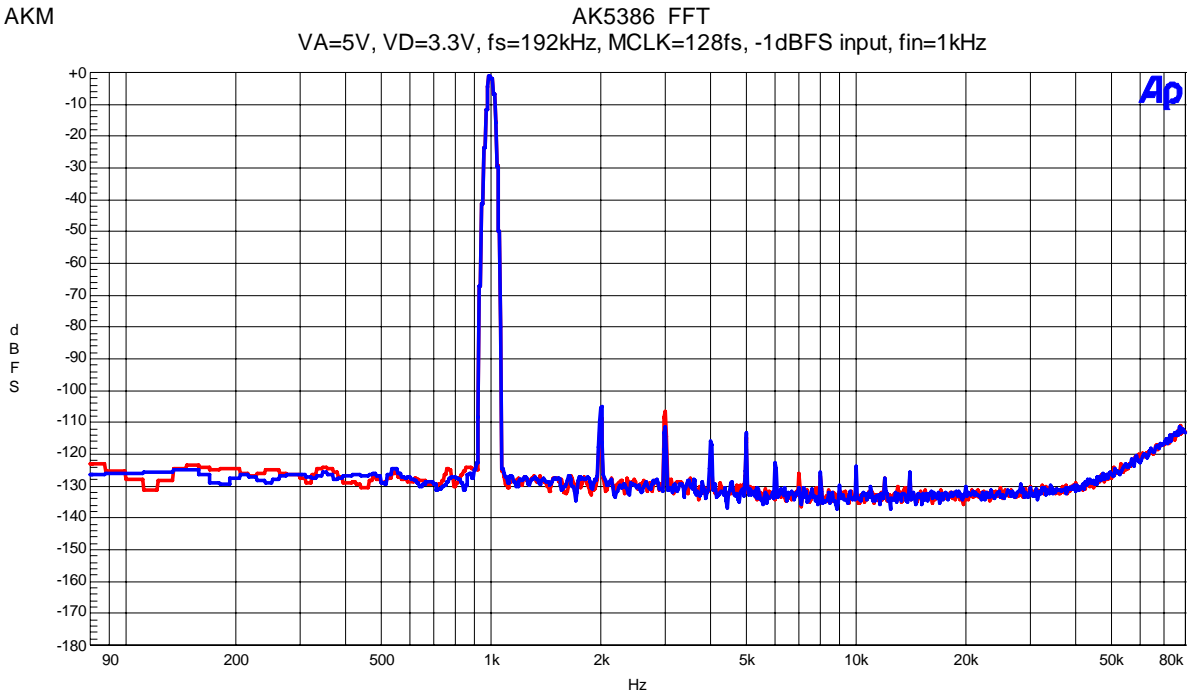

Figure 19 FFT (1kHz, -1dB input)

AKM

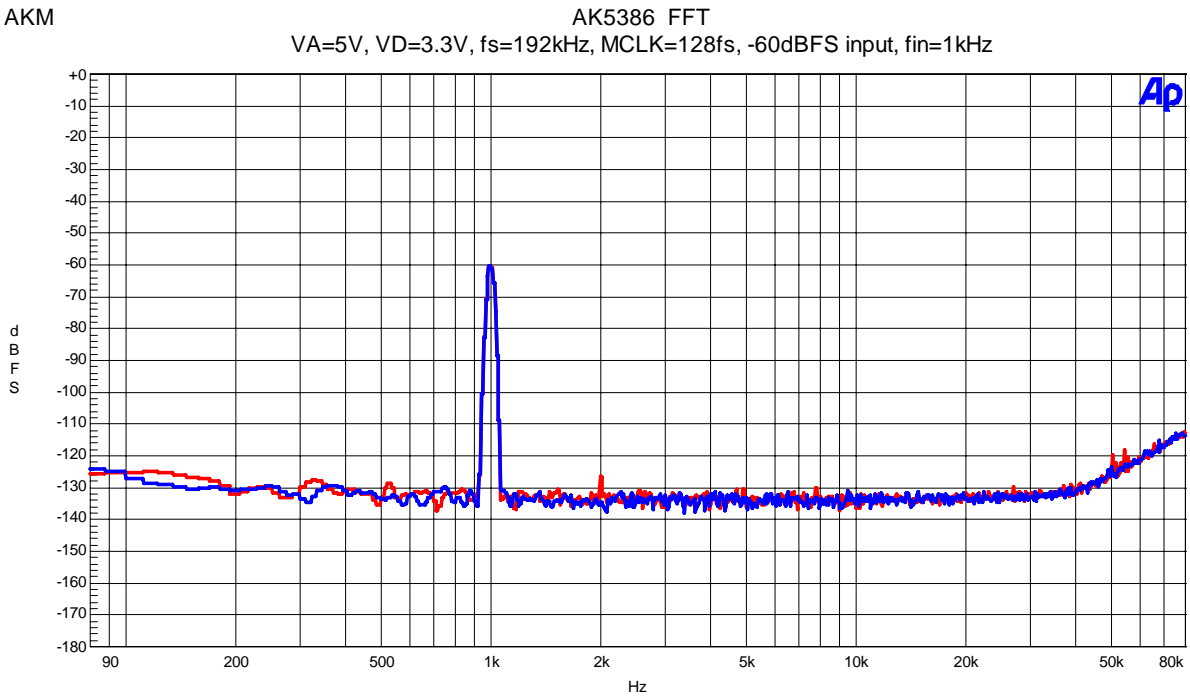

Figure 20 FFT (1kHz, -60dB input)

AKM

AK5386 FFT
VA=5V, VD=3.3V, fs=192kHz, MCLK=128fs, fin=No signal

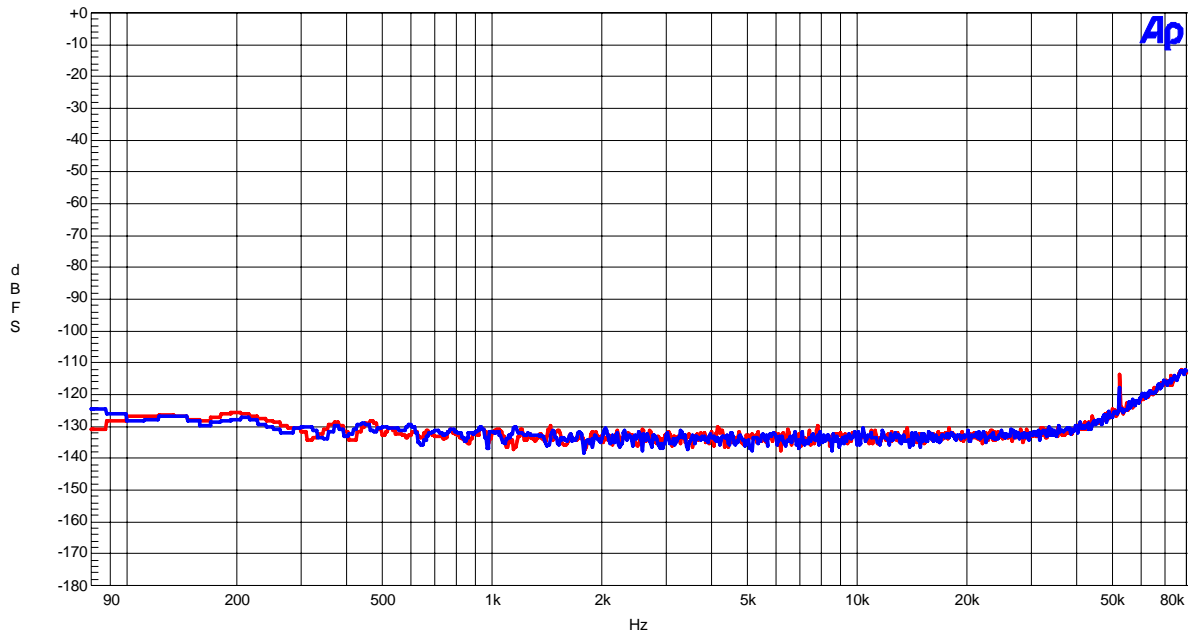

Figure 21 FFT (off the input)

AKM

AK5386 THD+N vs. Input Level
VA=5V, VD=3.3V, fs=192kHz, MCLK=128fs, fin=1kHz

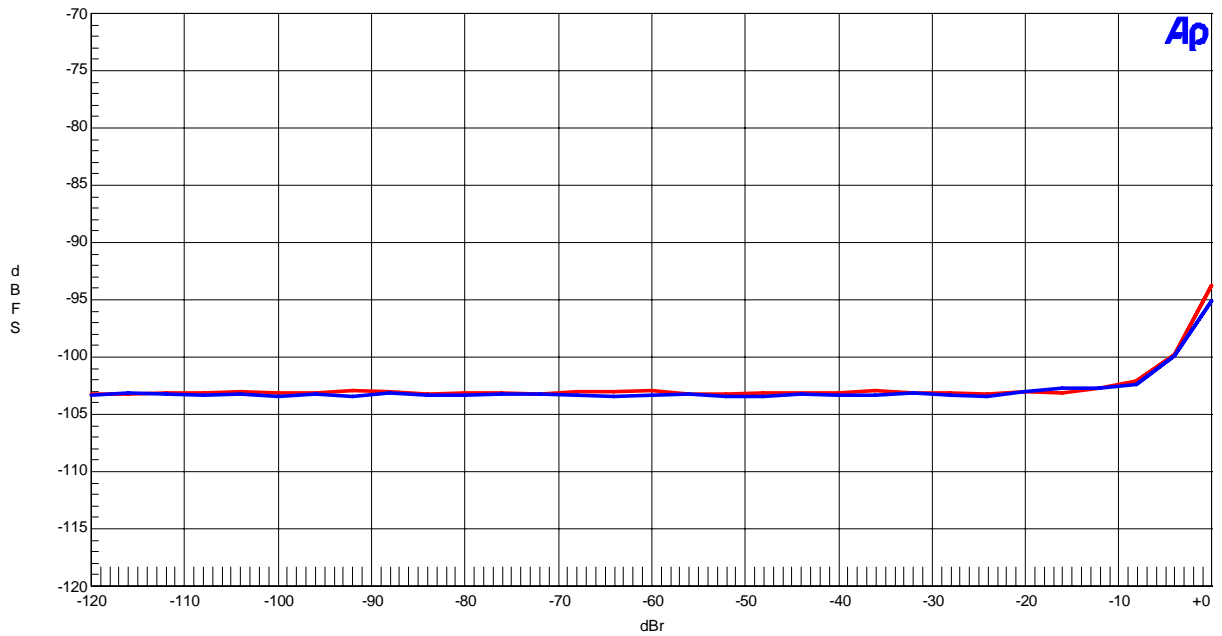

Figure 22 THD+N vs Input Level (1kHz input)

AKM

AK5386 THD+N vs. Input Frequency
 VA=5V, VD=3.3V, fs=192kHz, MCLK=128fs, -1dBFS input

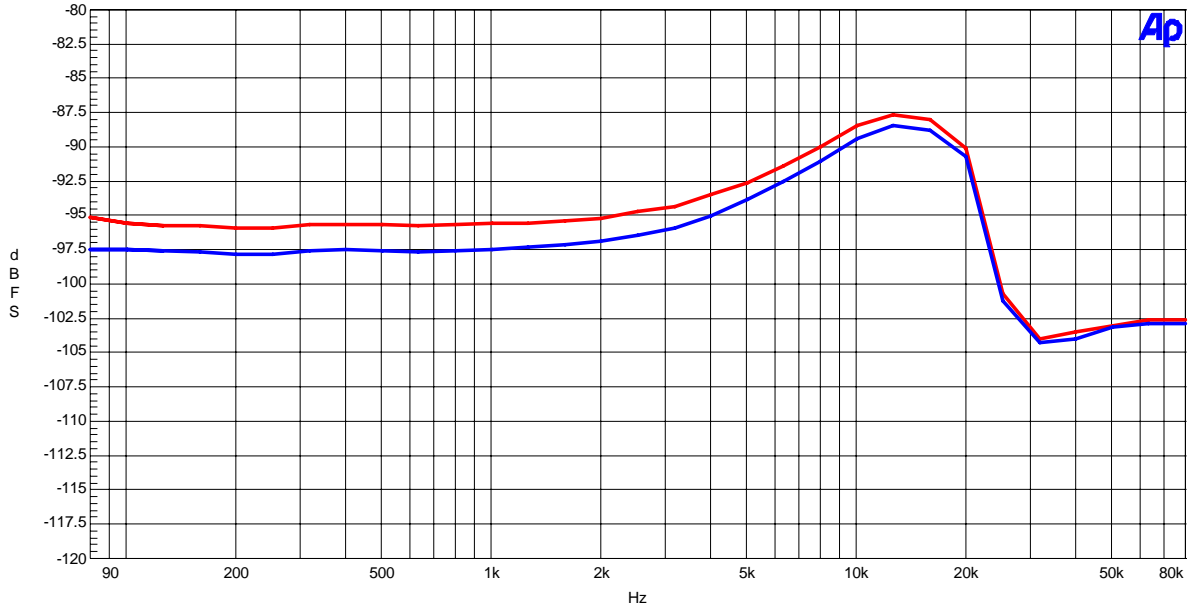

Figure 23 THD+N vs Input Frequency (-1dB input)

AKM

AK5386 Linearity
 VA=5V, VD=3.3V, fs=192kHz, MCLK=128fs, fin=1kHz

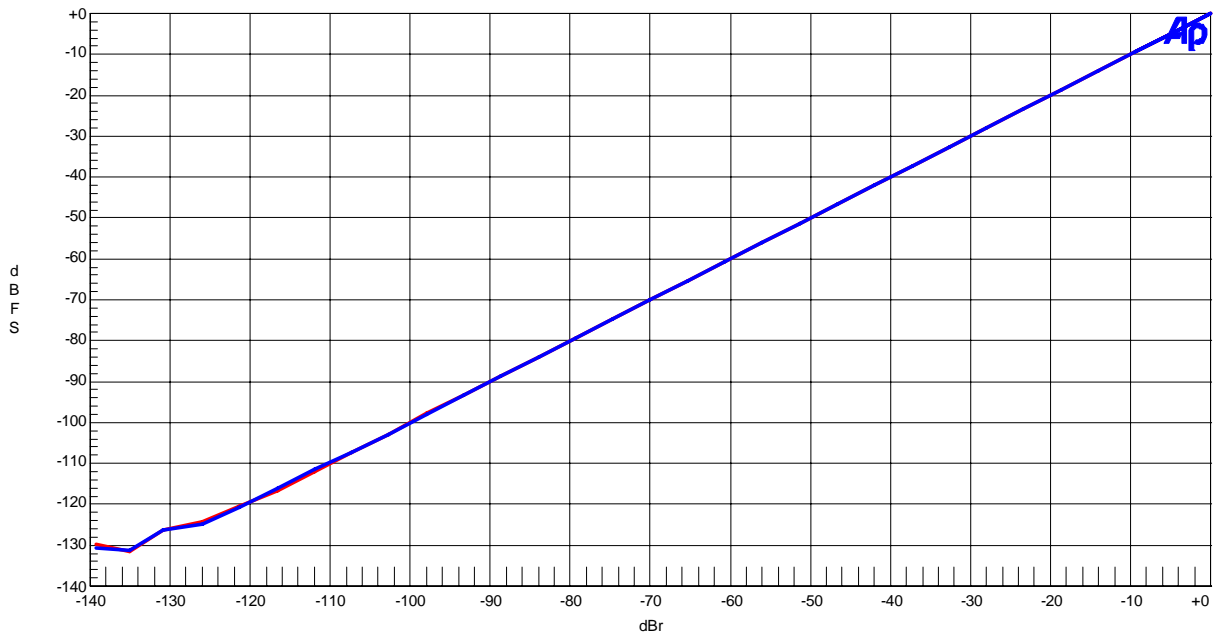

Figure 24 Linearity (fin=1kHz)

AKM

AK5386 Frequency Response
VA=5V, VD=3.3V, fs=192kHz, MCLK=128fs, -1dBFS input

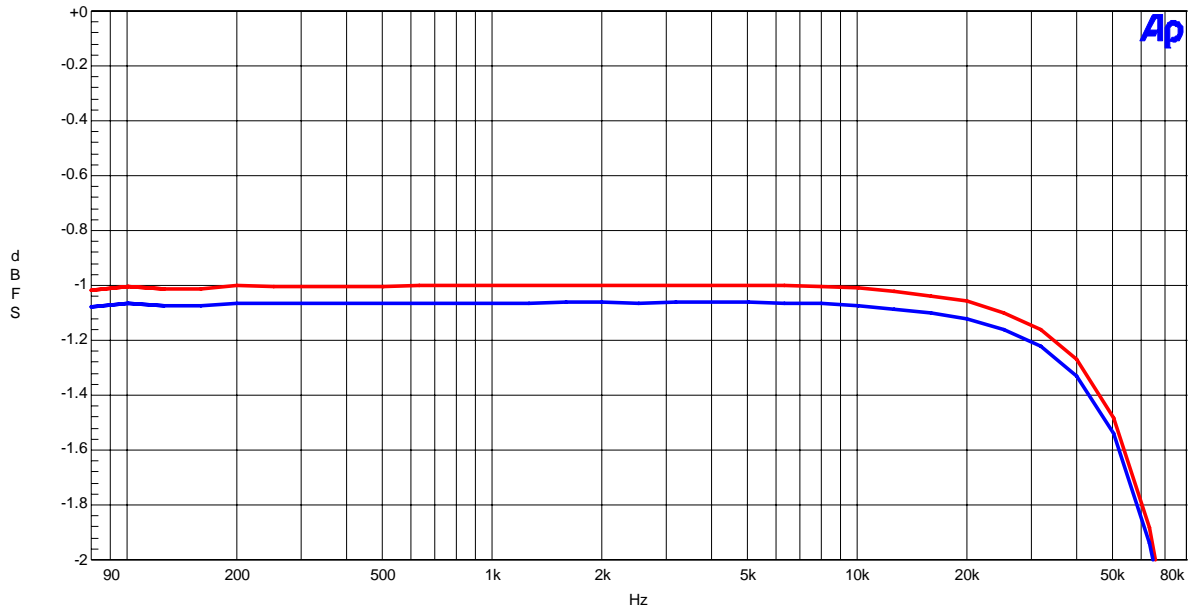

Figure 25 Frequency Response (-1dB input)

AKM

AK5386 Crosstalk (Red=Lch, Blue=Rch)
VA=5V, VD=3.3V, fs=192kHz, MCLK=128fs, -1dBFS input

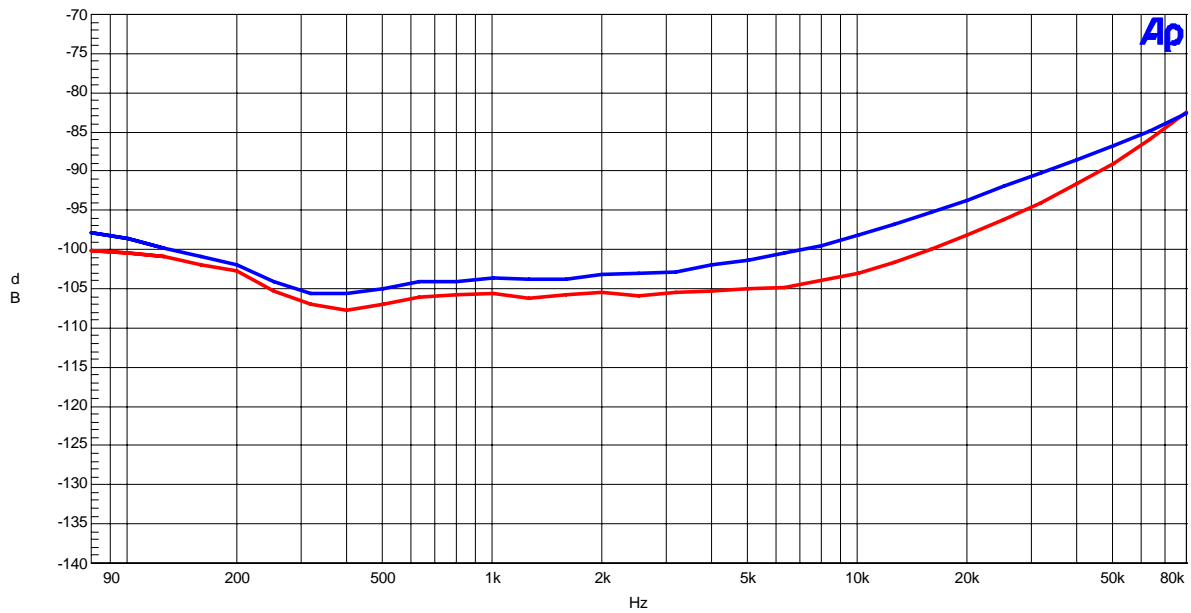

Figure 26 Cross-talk (-1dB input)

Revision History

Date (YY/MM/DD)	Manual Revision	Board Revision	Reason	Contents
06/12/08	KM082300		First Edition	

IMPORTANT NOTICE

- These products and their specifications are subject to change without notice. Before considering any use or application, consult the Asahi Kasei Microsystems Co., Ltd. (AKM) sales office or authorized distributor concerning their current status.
- AKM assumes no liability for infringement of any patent, intellectual property, or other right in the application or use of any information contained herein.
- Any export of these products, or devices or systems containing them, may require an export license or other official approval under the law and regulations of the country of export pertaining to customs and tariffs, currency exchange, or strategic materials.
- AKM products are neither intended nor authorized for use as critical components in any safety, life support, or other hazard related device or system, and AKM assumes no responsibility relating to any such use, except with the express written consent of the Representative Director of AKM. As used here:
 - (a) A hazard related device or system is one designed or intended for life support or maintenance of safety or for applications in medicine, aerospace, nuclear energy, or other fields, in which its failure to function or perform may reasonably be expected to result in loss of life or in significant injury or damage to person or property.
 - (b) A critical component is one whose failure to function or perform may reasonably be expected to result, whether directly or indirectly, in the loss of the safety or effectiveness of the device or system containing it, and which must therefore meet very high standards of performance and reliability.
- It is the responsibility of the buyer or distributor of an AKM product who distributes, disposes of, or otherwise places the product with a third party to notify that party in advance of the above content and conditions, and the buyer or distributor agrees to assume any and all responsibility and liability for and hold AKM harmless from any and all claims arising from the use of said product in the absence of such notification.

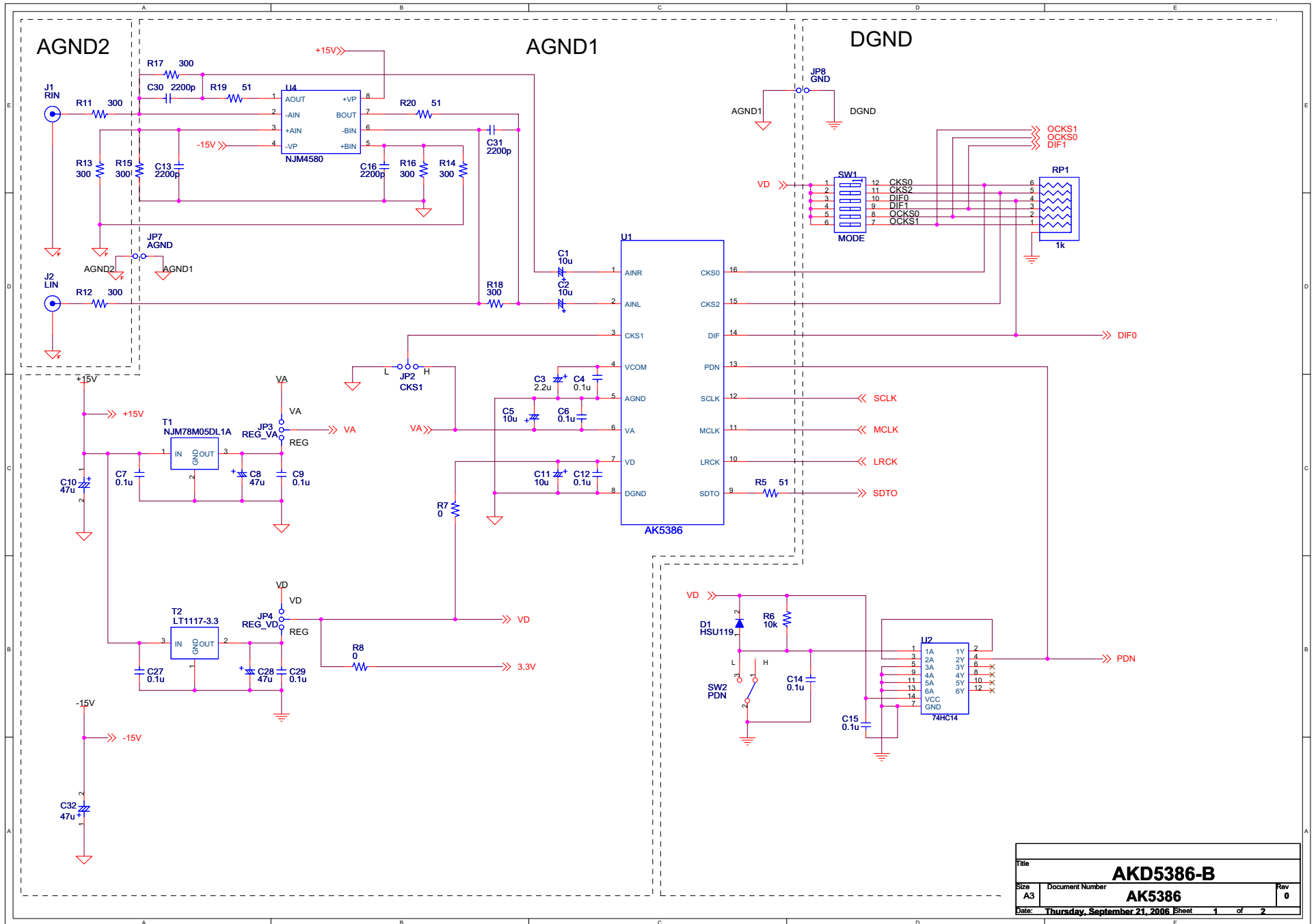

Title			AKD5386-B
Size	Document Number	AK5386	
A3			Rev 0
Date: Thursday, September 21, 2006 Sheet 1 of 2			

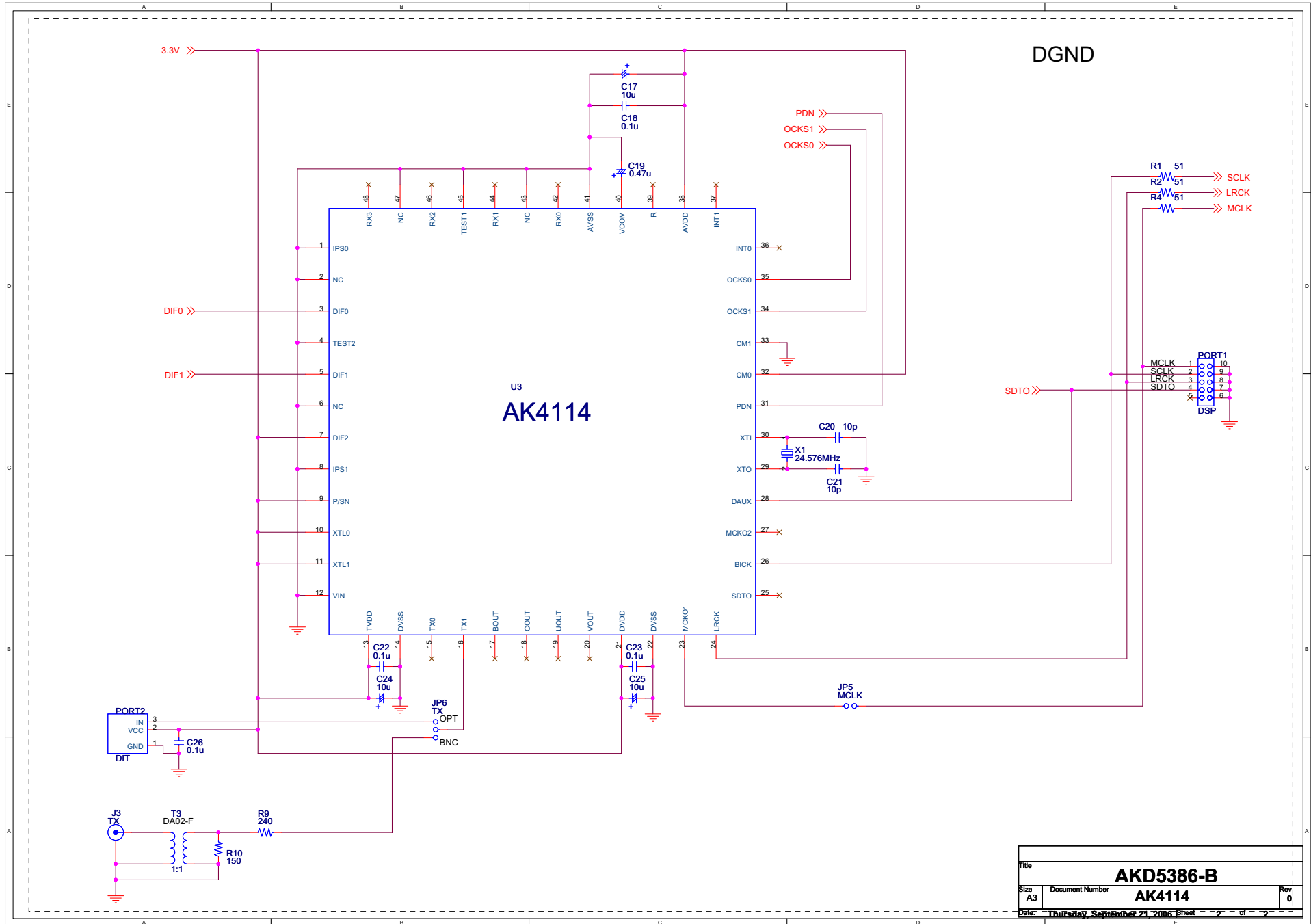

Title		AKD5386-B	
Size	Document Number	AK4114	
A3			Rev 01
Date: Thursday, September 21, 2006 Sheet 2 of 2			

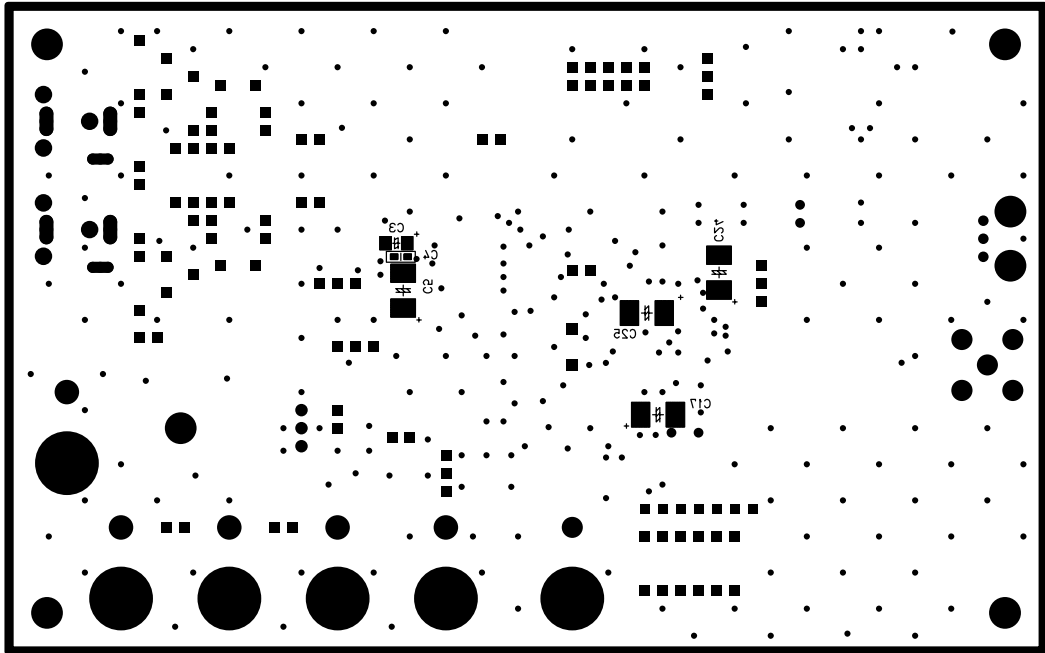

AKD238E-B LS SILK

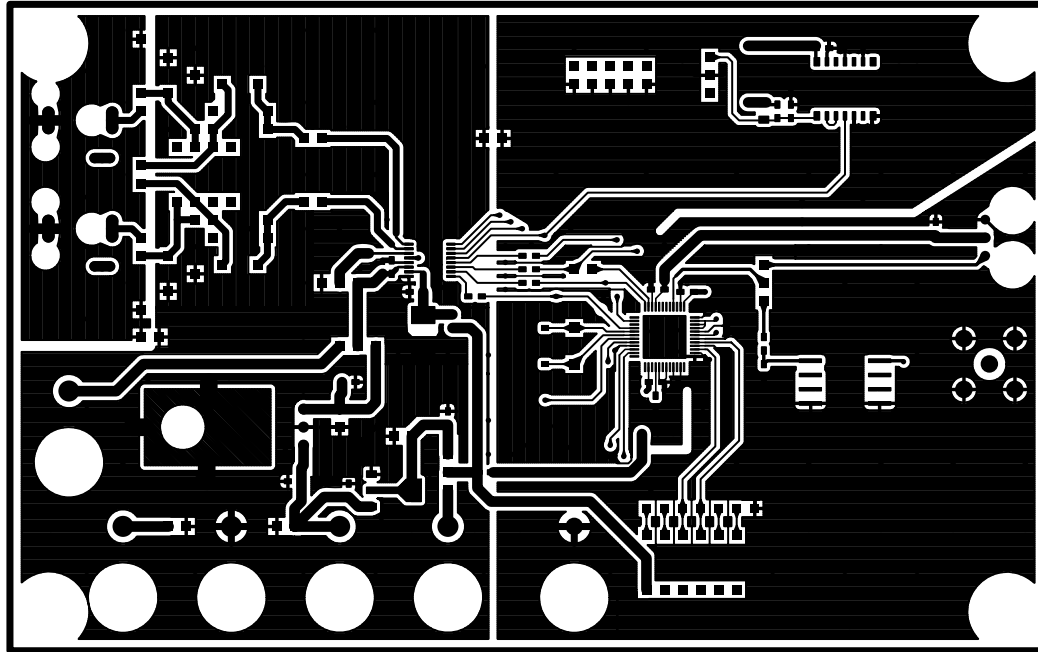

AKD5386-B L1

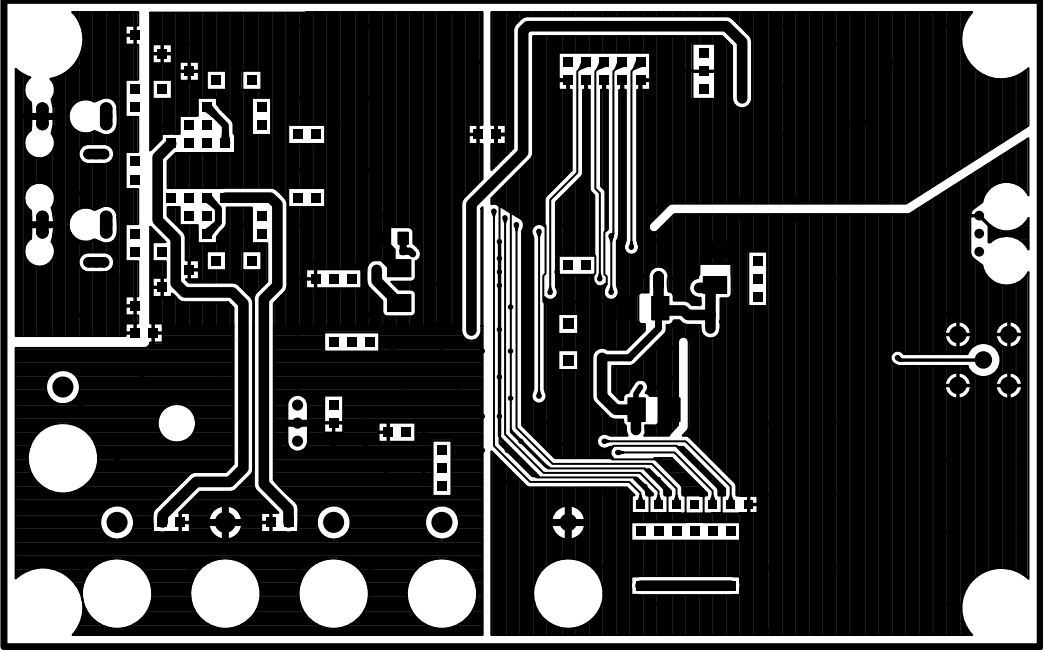

AKD238E-B JS