

# 10G Base-T, Single, LAN Transformer, w/ PoE, 3 Wires

ALAN-2401

RoHS/RoHS II Compliant



17.50 x 15.60 x 5.40mm

## FEATURES:

- Meet IEEE802.3 specification
- Power Over Ethernet(PoE)IEEE802.3at compliant performance
- Extended Temperature (-40°C - +85°C)
- ROHS peak reflow temperature rating 245°C
- 1500Vrms Hi-Pot

## APPLICATIONS:

- Designed for most leading PHY IC manufacturers such as Broadcom, Marvell, Micrel, & Microsemi
- 10G Ethernet-LAN
- PoE Capabilities
- Provides signal conditioning, EMI suppression and signal isolation.
- Hubs/Switches/Routers/Servers/NIC Cards

## STANDARD SPECIFICATIONS:

### Key Electrical Specifications @ 25°C

Parameters	Minimum	Typical	Maximum	Units	Notes
Operating Temperature	0		+70	°C	
Storage Temperature	-40		+85	°C	
Turn Ratio (± 3%)		1CT:1CT			
Inductance (OCL)	120			μH	100KHz/0.1V@8mA
Leakage Inductance (LL)			0.5	μH	100KHz/0.1V
Cw/w			30	pF	100KHz/0.1V
DC Resistance			1.2	Ω	
Insertion Loss			-1.2	dB	1- 400MHz
Return Loss	-18			dB	1- 40MHz
	-17+10log(F/40MHz)				40-500MHz
Cross Talk		-40		dB	1-100MHz
		-30			100-500MHz
CM-DM Rejection Ratio		-30			1-250MHz
		-22			250-500MHz
Differential to Common Mode Rejection	-30			dB	1-100MHz
Common Mode Rejection	-30			dB	1-100MHz
PoE Current Capacity			350	mA	
Hi-Pot	1500Vrms/0.5mA/60Sec or 1650Vrms/0.5mA/2Sec				

# 10G Base-T, Single, LAN Transformer, w/ PoE, 3 Wires

ALAN-2401

RoHS/RoHS II Compliant



17.50 x 15.60 x 5.40mm

## OUTLINE DIMENSIONS:

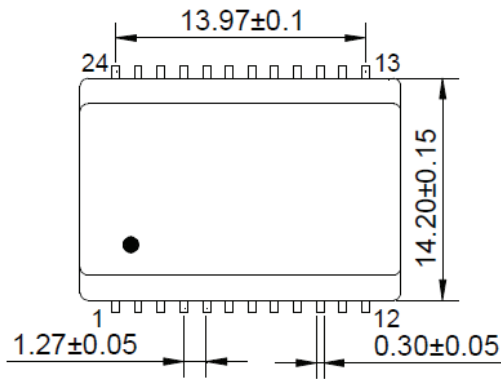

## Recommended Land Pattern

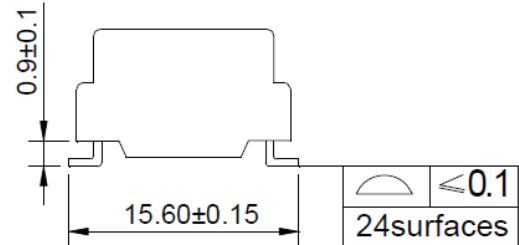
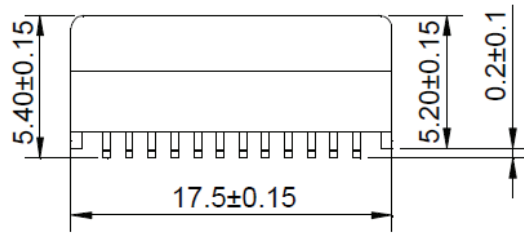
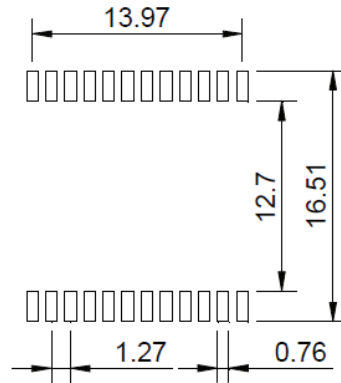

Dimensions: mm (Unless otherwise specified, tolerances are  $\pm 0.25$ )

## SCHEMATICS

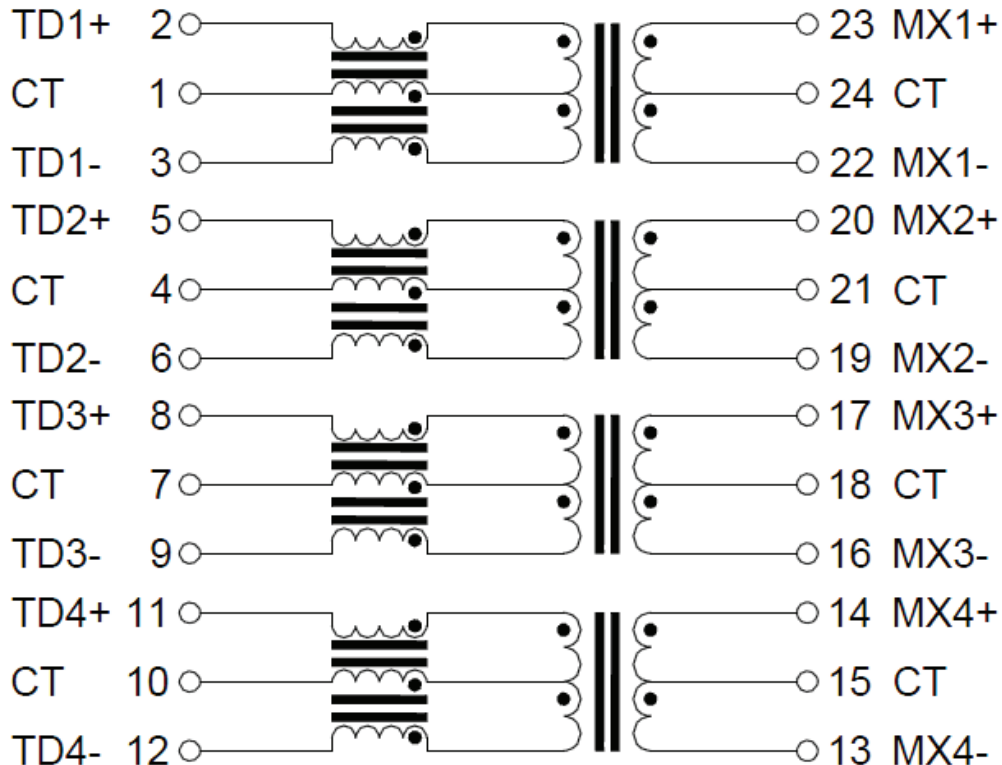

# 10G Base-T, Single, LAN Transformer, w/ PoE, 3 Wires

ALAN-2401

RoHS/RoHS II Compliant

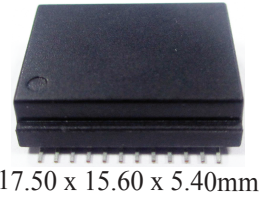

17.50 x 15.60 x 5.40mm

## REFLOW PROFILE:

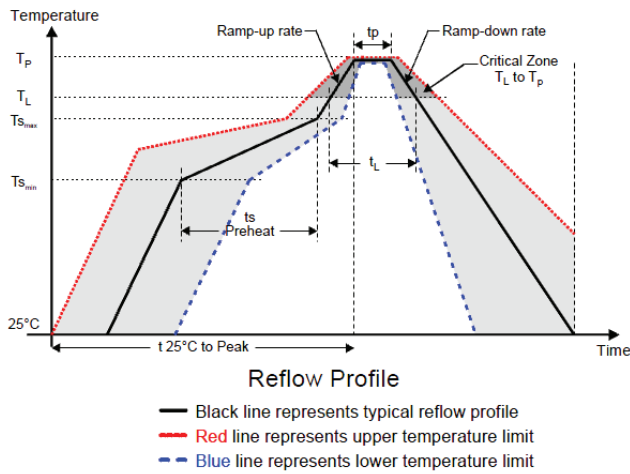

Profile Feature	Pb-Free Assembly
Average Ramp-Up Rate (Ts <sub>max</sub> to Tp)	3°C /second max.
Preheat	
-Temperature Min (Ts <sub>min</sub> )	150°C
-Temperature Max (Ts <sub>max</sub> )	200°C
-Time (ts <sub>min</sub> to ts <sub>max</sub> )	60-120 seconds
<b>Time maintained above:</b>	
-Temperature (TL)	217°C
-Time (tL)	60-150 seconds
Peak/Classification Temperature (Tp)	245+0/-5°C
Time within 5°C of actual Peak Temperature (tp)	20-40 seconds
Ramp-Down Rate	6°C /seconds max
Time 25°C to Peak Temperature	8 minutes max.

## TAPE & REEL:

**Packing :** 400 pcs / reel  
**Weight** 2.1 grams / pcs

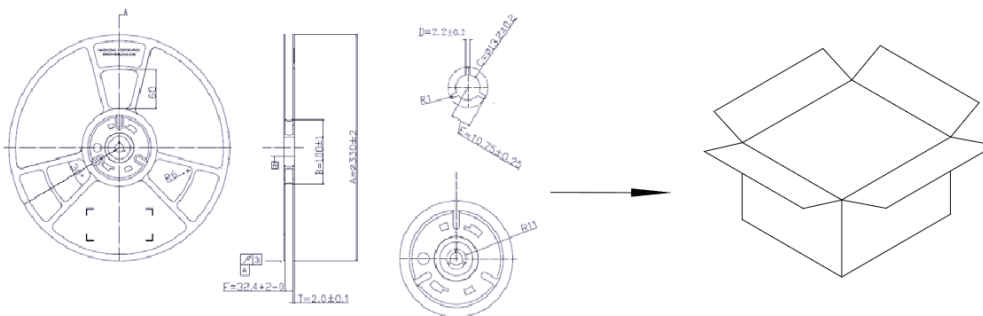
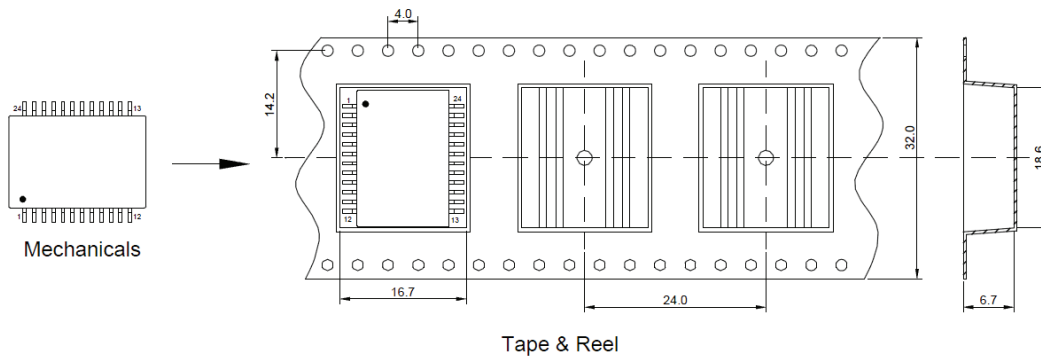

**Dimensions: mm**

**ATTENTION:** Abracon Corporation's products are COTS – Commercial-Off-The-Shelf products; suitable for Commercial, Industrial and, where designated, Automotive Applications. Abracon's products are not specifically designed for Military, Aviation, Aerospace, Life-dependant Medical applications or any application requiring high reliability where component failure could result in loss of life and/or property. For applications requiring high reliability and/or presenting an extreme operating environment, written consent and authorization from Abracon Corporation is required. Please contact Abracon Corporation for more information.

ABRACON IS  
ISO 9001:2008  
CERTIFIED



2 Faraday, Suite# B | Irvine | CA 92618 **Revised: 03.24.15**  
 Ph. 949.546.8000 | Fax. 949.546.8001  
 Visit [www.abracon.com](http://www.abracon.com) for Terms and Conditions of Sale