



5V RAIL-TO-RAIL PRECISION OPERATIONAL AMPLIFIER

GENERAL DESCRIPTION

The ALD1702/ALD1703 is a monolithic operational amplifier intended primarily for a wide range of analog applications in +5V single power supply and $\pm 5V$ dual power supply systems as well as +4V to +12V battery operated systems. All device characteristics are specified for +5V single supply or $\pm 2.5V$ dual supply systems. It is manufactured with Advanced Linear Devices' enhanced AC MOS silicon gate CMOS process.

The device is designed to offer a balanced trade-off of performance parameters providing a wide range of desired specifications. It offers the industry pin configuration of $\mu A741$ and ICL7611 types.

The ALD1702/ALD1703 has been developed specifically with the 5V single supply or ± 2.5 dual supply user in mind. Several important characteristics of the device make many applications easy to implement for these supply voltages. First, the operational amplifier can operate with rail to rail input and output voltages. This feature allows numerous analog serial stages to be implemented without losing operating voltage margin. Secondly, the device was designed to accommodate mixed applications where digital and analog circuits may work off the same 5V power supply. Thirdly, the output stage can drive up to 400pF capacitive and 5K Ω resistive loads in non-inverting unity gain connection and double the capacitance in the inverting unity gain mode.

These features, coupled with extremely low input currents, high voltage gain, useful bandwidth of 1.5MHz, slew rate of 2.1V/ μs , low power dissipation, low offset voltage and temperature drift, make the ALD1702/ALD1703 a truly versatile, user friendly, operational amplifier.

The ALD1702/ALD1703 is designed and fabricated with silicon gate CMOS technology, and offers 1pA typical input bias current. On-chip offset voltage trimming allows the device to be used without nulling in most applications. The device offers typical offset drift of less than 7 $\mu V/^{\circ}C$ which eliminates many trim or temperature compensation circuits. For precision applications, the ALD1702 is designed to settle to 0.01% in 8 μs .

FEATURES

- Rail-to-rail input and output voltage ranges
- All parameters specified for +5V single supply or $\pm 2.5V$ dual supply systems.
- High load capacitance capability -- 4000pF typical
- No frequency compensation required -- unity gain stable
- Extremely low input bias currents -- 1.0pA typical (30pA max.)
- Ideal for high source impedance applications
- Dual power supply $\pm 2.5V$ to $\pm 5.0V$ operation
- Single power supply +5V to +12V operation
- High voltage gain -- typically 85V/mV @ $\pm 2.5V$ and 250V/mV @ $\pm 5.0V$
- Drive as low as 2K Ω load with 5mA drive current
- Output short circuit protected
- Unity gain bandwidth of 1.5MHz (1.0MHz min.)
- Slew rate of 2.1V/ μs (1.4V/ μs min.)
- Low power dissipation

APPLICATIONS

- Voltage amplifier
- Voltage follower/buffer
- Charge integrator
- Photodiode amplifier
- Data acquisition systems
- High performance portable instruments
- Signal conditioning circuits
- Sensor and transducer amplifiers
- Low leakage amplifiers
- Active filters
- Sample/Hold amplifier
- Picoammeter
- Current to voltage converter
- Coaxial cable driver

ORDERING INFORMATION

Operating Temperature Range		
-55 $^{\circ}C$ to +125 $^{\circ}C$	0 $^{\circ}C$ to +70 $^{\circ}C$	0 $^{\circ}C$ to +70 $^{\circ}C$
8-Pin CERDIP Package	8-Pin Small Outline Package (SOIC)	8-Pin Plastic Dip Package
ALD1702A DA	ALD1702A SA	ALD1702A PA
ALD1702B DA	ALD1702B SA	ALD1702B PA
ALD1702 DA	ALD1702 SA	ALD1702 PA
ALD1703 DA	ALD1703 SA	ALD1703 PA

* Contact factory for industrial temperature range

PIN CONFIGURATION

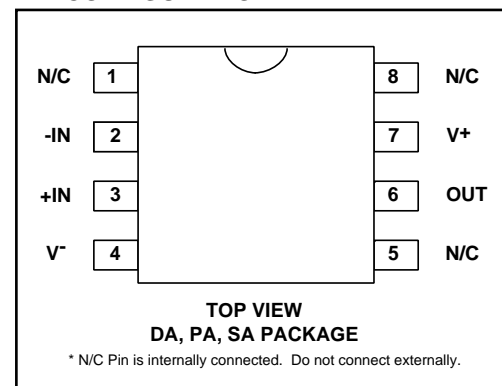

ABSOLUTE MAXIMUM RATINGS

Supply voltage, V+	_____	13.2V
Differential input voltage range	_____	-0.3V to V+ +0.3V
Power dissipation	_____	600 mW
Operating temperature range	PA, SA package _____	0°C to +70°C
	DA package _____	-55°C to +125°C
Storage temperature range	_____	-65°C to +150°C
Lead temperature, 10 seconds	_____	+260°C

OPERATING ELECTRICAL CHARACTERISTICS

T_A = 25°C V_S = ±2.5V unless otherwise specified

Parameter	Symbol	1702A			1702B			1702			1703			Unit	Test Conditions
		Min	Typ	Max	Min	Typ	Max	Min	Typ	Max	Min	Typ	Max		
Supply Voltage	V _S V+	±2.0 4.0		±6.0 12.0	±2.0 4.0		±6.0 12.0	±2.0 4.0		±6.0 12.0	±2.0 4.0		±6.0 12.0	V	Single Supply
Input Offset Voltage	V _{OS}			0.9 1.7			2.0 2.8			4.5 5.3			10.0 11.0	mV mV	R _S ≤ 100KΩ 0°C ≤ T _A ≤ +70°C
Input Offset Current	I _{OS}		1.0	25 240		1.0	25 240		1.0	25 240		1.0	30 450	pA pA	T _A = 25°C 0°C ≤ T _A ≤ +70°C
Input Bias Current	I _B		1.0	30 300		1.0	30 300		1.0	30 300		1.0	50 600	pA pA	T _A = 25°C 0°C ≤ T _A ≤ +70°C
Input Voltage Range	V _{IR}	-0.3 -2.8		5.3 2.8	-0.3 -2.8		5.3 2.8	-0.3 -2.8		5.3 2.8	0.15 -2.35		4.85 2.35	V V	V+ = +5V V _S = ±2.5V
Input Resistance	R _{IN}		10 ¹²			10 ¹²			10 ¹²			10 ¹²		Ω	
Input Offset Voltage Drift	TCV _{OS}		7			7			7			10		μV/°C	R _S ≤ 100KΩ
Power Supply Rejection Ratio	PSRR	70 70	80 80		65 65	80 80		65 65	80 80		60 60	80 80		dB dB	R _S ≤ 100KΩ 0°C ≤ T _A ≤ +70°C
Common Mode Rejection Ratio	CMRR	70 70	83 83		65 65	83 83		65 65	83 83		60 60	83 83		dB dB	R _S ≤ 100KΩ 0°C ≤ T _A ≤ +70°C
Large Signal Voltage Gain	A _v	50 20	85 400		50 20	85 400		50 20	85 400		32 10	85 300		V/mV V/mV V/mV	R _L = 10KΩ R _L ≥ 1MΩ R _L = 10KΩ 0°C ≤ T _A ≤ +70°C
Output Voltage Range	V _O low V _O high		0.002 4.998	0.01		0.002 4.998	0.01		0.002 4.998	0.01		0.002 4.998	0.01	V V	R _L = 1MΩ V+ = 5V 0°C ≤ T _A ≤ +70°C
	V _O low V _O high	4.99 2.35	-2.44 2.44	-2.35		-2.44 2.44	-2.35		-2.44 2.44	-2.35		-2.4 2.4	-2.3	V	R _L = 10KΩ 0°C ≤ T _A ≤ +70°C
Output Short Circuit Current	I _{SC}		8			8			8			8		mA	
Supply Current	I _S		1.1	2.0		1.1	2.0		1.1	2.0		1.1	2.5	mA	V _{IN} = 0V No Load
Power Dissipation	P _D		5.5	10.0		5.5	10.0		5.5	10.0		5.5	12.5	mW	V _S = ±2.5V
Input Capacitance	C _{IN}		1			1			1			1		pF	
Bandwidth	B _W	1.0	1.5		1.0	1.5		1.0	1.5		0.7	1.5		MHz	
Slew Rate	S _R	1.4	2.1		1.4	2.1		1.4	2.1		1.1	2.1		V/μs	A _v = +1 R _L = 10KΩ
Rise time	t _r		0.2			0.2			0.2			0.2		μs	R _L = 10KΩ C _L = 100pF

OPERATING ELECTRICAL CHARACTERISTICS (cont'd)

$T_A = 25^\circ\text{C}$ $V_S = \pm 2.5\text{V}$ unless otherwise specified

Parameter	Symbol	1702A			1702B			1702			1703			Unit	Test Conditions
		Min	Typ	Max	Min	Typ	Max	Min	Typ	Max	Min	Typ	Max		
Overshoot Factor			10			10			10			10		%	$R_L = 10\text{K}\Omega$ $C_L = 100\text{pF}$
Maximum Load Capacitance	C_L		400 4000			400 4000			400 4000			400 4000		pF pF	Gain = 1 Gain = 5
Input Noise Voltage	e_n		26			26			26			26		$\text{nV}/\sqrt{\text{Hz}}$	$f = 1\text{KHz}$
Input Current Noise	i_n		0.6			0.6			0.6			0.6		$\text{fA}/\sqrt{\text{Hz}}$	$f = 10\text{Hz}$
Settling Time	t_s		8.0 3.0			8.0 3.0			8.0 3.0			8.0 3.0		μs μs	0.01% 0.1% $A_V = -1$ $R_L = 5\text{K}\Omega$ $C_L = 50\text{pF}$

$T_A = 25^\circ\text{C}$ $V_S = \pm 5.0\text{V}$ unless otherwise specified

Parameter	Symbol	1702A			1702B			1702			1703			Unit	Test Conditions
		Min	Typ	Max	Min	Typ	Max	Min	Typ	Max	Min	Typ	Max		
Power Supply Rejection Ratio	PSRR		83			83			83			83		dB	$R_S \leq 100\text{K}\Omega$
Common Mode Rejection Ratio	CMRR		83			83			83			83		dB	$R_S \leq 100\text{K}\Omega$
Large Signal Voltage Gain	A_V		250			250			250			250		V/mV	$R_L = 10\text{K}\Omega$
Output Voltage Range	V_O low V_O high	4.8	-4.9 4.93	-4.8	4.8	-4.9 4.93	-4.8	4.8	-4.9 4.93	-4.8	4.8	-4.9 4.93	-4.8	V	$R_L = 10\text{K}\Omega$
Bandwidth	BW		1.7			1.7			1.7			1.7		MHz	
Slew Rate	S_R		2.8			2.8			2.8			2.8		V/ μs	$A_V = +1$ $C_L = 50\text{pF}$

$V_S = \pm 2.5\text{V}$ $-55^\circ\text{C} \leq T_A \leq +125^\circ\text{C}$ unless otherwise specified

Parameter	Symbol	1702A DA			1702B DA			1702 DA			Unit	Test Conditions
		Min	Typ	Max	Min	Typ	Max	Min	Typ	Max		
Input Offset Voltage	V_{OS}			3.0			4.0			6.5	mV	$R_S \leq 100\text{K}\Omega$
Input Offset Current	I_{OS}			8.0			8.0			8.0	nA	
Input Bias Current	I_B			10.0			10.0			10.0	nA	
Power Supply Rejection Ratio	PSRR	60	75		60	75		60	75		dB	$R_S \leq 100\text{K}\Omega$
Common Mode Rejection Ratio	CMRR	60	83		60	83		60	83		dB	$R_S \leq 100\text{K}\Omega$
Large Signal Voltage Gain	A_V	10	25		10	25		7	25		V/mV	$R_L = 10\text{K}\Omega$
Output Voltage Range	V_O low V_O high	4.8	0.1 4.9	0.2	4.8	0.1 4.9	0.2	4.8	0.1 4.9	0.2	V	$R_L = 10\text{K}\Omega$

Design & Operating Notes:

1. The ALD1702/ALD1703 CMOS operational amplifier uses a 3 gain stage architecture and an improved frequency compensation scheme to achieve large voltage gain, high output driving capability, and better frequency stability. In a conventional CMOS operational amplifier design, compensation is achieved with a pole splitting capacitor together with a nulling resistor. This method is, however, very bias dependent and thus cannot accommodate the large range of supply voltage operation as is required from a stand alone CMOS operational amplifier. The ALD1702 is internally compensated for unity gain stability using a novel scheme that does not use a nulling resistor. This scheme produces a clean single pole roll off in the gain characteristics while providing for more than 70 degrees of phase margin at the unity gain frequency. A unity gain buffer using the ALD1702 will typically drive 400pF of external load capacitance without stability problems. In the inverting unity gain configuration, it can drive up to 800pF of load capacitance. Compared to other CMOS operational amplifiers, the ALD1702 has shown itself to be more resistant to parasitic oscillations.
2. The ALD1702/ALD1703 has complementary p-channel and n-channel input differential stages connected in parallel to accomplish rail to rail input common mode voltage range. This means that with the ranges of common mode input voltage close to the power supplies, one of the two differential stages is switched off internally. To maintain compatibility with other operational amplifiers, this switching point has been selected to be about 1.5V above the negative supply voltage. Since offset voltage trimming on the ALD1702/ALD1703 is made when the input voltage is symmetrical to the supply voltages, this internal switching does not affect a large variety of applications such as an inverting amplifier or non-inverting amplifier with a gain larger than 2.5 (5V operation), where the common mode voltage does not make excursions below this switching point. The user should however, be

aware that this switching does take place if the operational amplifier is connected as a unity gain buffer and should make provision in his design to allow for input offset voltage variations.

3. The input bias and offset currents are essentially input protection diode reverse bias leakage currents, and are typically less than 1pA at room temperature. This low input bias current assures that the analog signal from the source will not be distorted by input bias currents. Normally, this extremely high input impedance of greater than $10^{12}\Omega$ would not be a problem as the source impedance would limit the node impedance. However, for applications where source impedance is very high, it may be necessary to limit noise and hum pickup through proper shielding.
4. The output stage consists of class AB complementary output drivers, capable of driving a low resistance load. The output voltage swing is limited by the drain to source on-resistance of the output transistors as determined by the bias circuitry, and the value of the load resistor. When connected in the voltage follower configuration, the oscillation resistant feature, combined with the rail to rail input and output feature, makes an effective analog signal buffer for medium to high source impedance sensors, transducers, and other circuit networks.
5. The ALD1702/ALD1703 operational amplifier has been designed to provide full static discharge protection. Internally, the design has been carefully implemented to minimize latch up. However, care must be exercised when handling the device to avoid strong static fields that may degrade a diode junction, causing increased input leakage currents. In using the operational amplifier, the user is advised to power up the circuit before, or simultaneously with, any input voltages applied and to limit input voltages to not exceed 0.3V of the power supply voltage levels.

TYPICAL PERFORMANCE CHARACTERISTICS

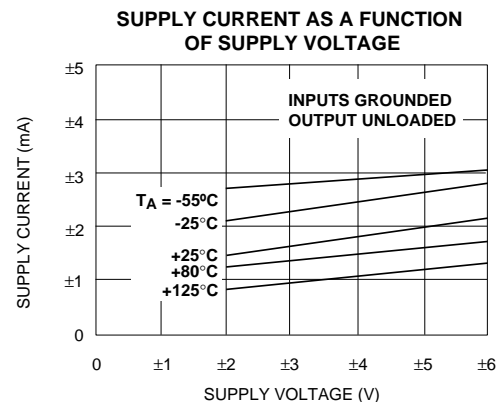
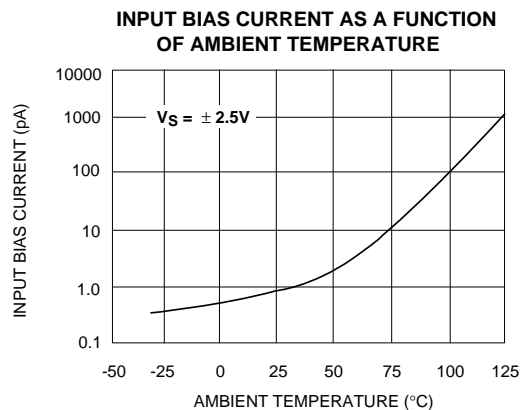
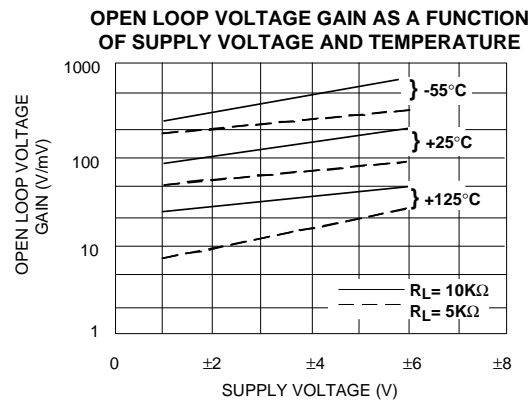
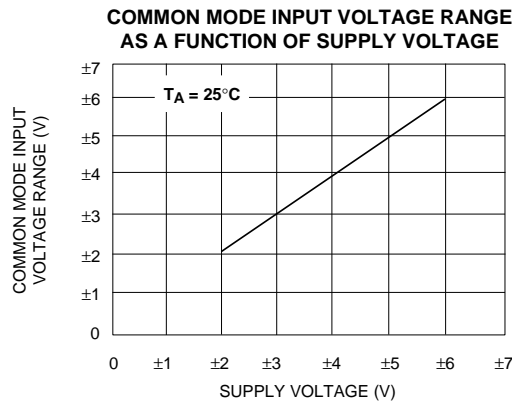

TYPICAL PERFORMANCE CHARACTERISTICS

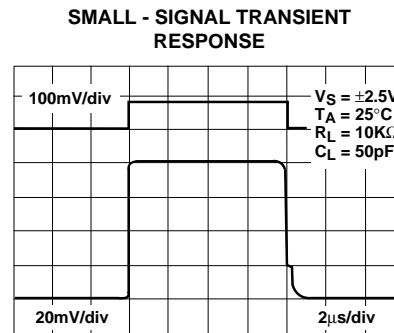
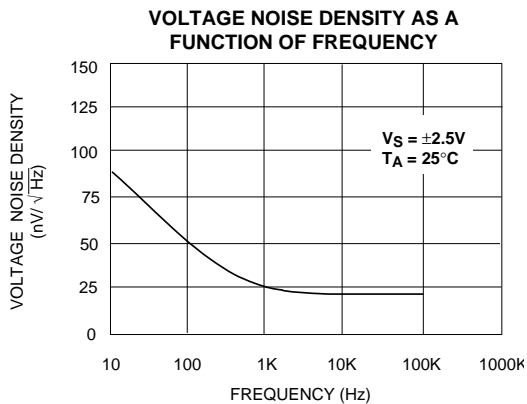
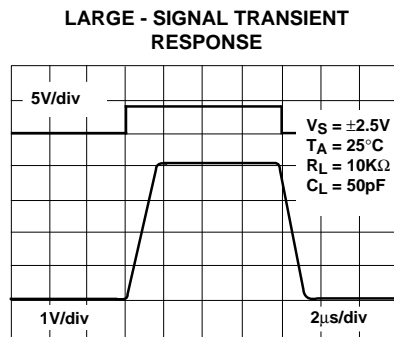
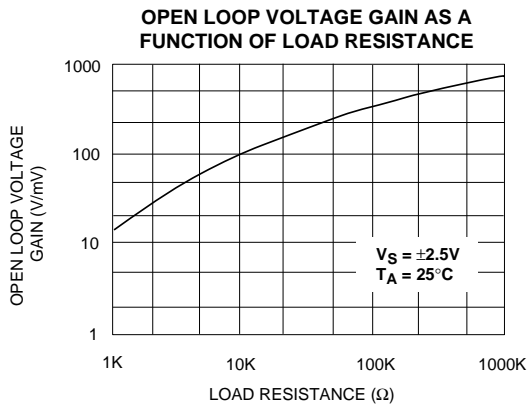
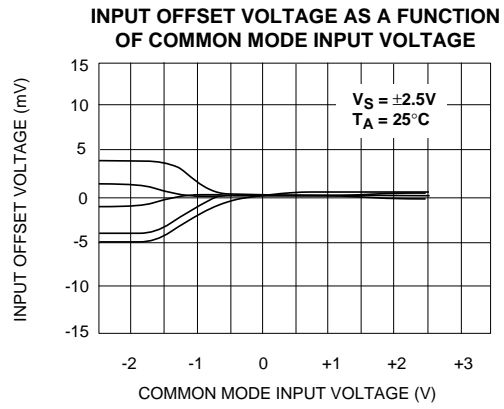
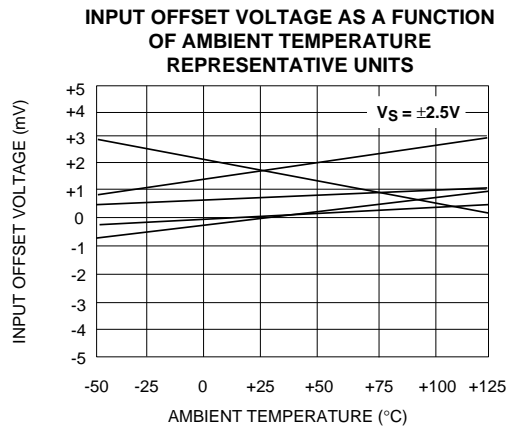
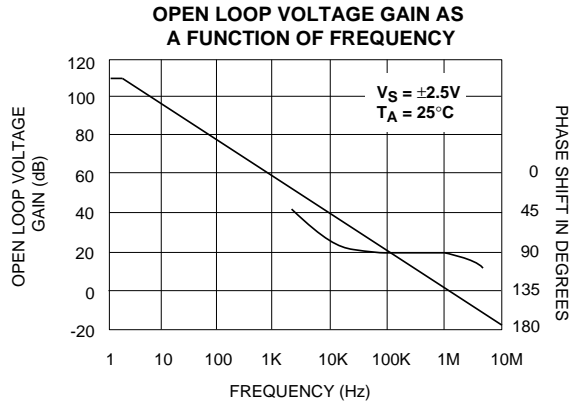
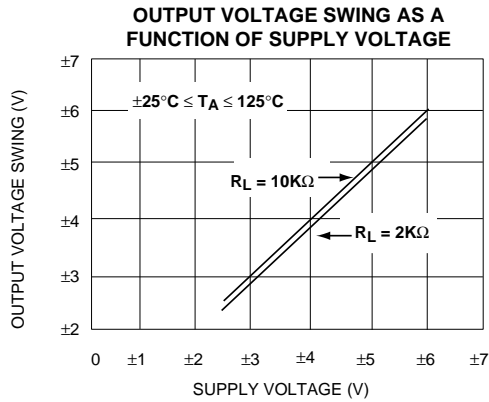

TYPICAL APPLICATIONS

RAIL TO RAIL VOLTAGE FOLLOWER/BUFFER

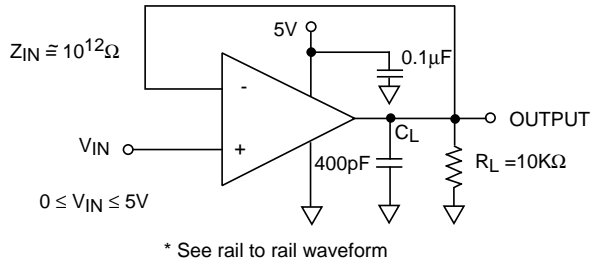

RAIL-TO-RAIL WAVEFORM

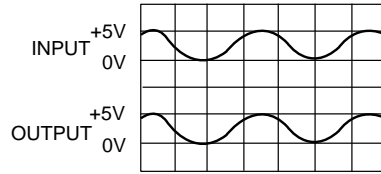

Performance waveforms.
Upper trace is the output of a Wien Bridge Oscillator. Lower trace is the output of Rail-to-rail voltage follower.

LOW OFFSET SUMMING AMPLIFIER

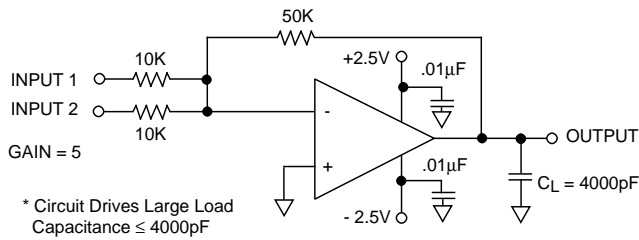
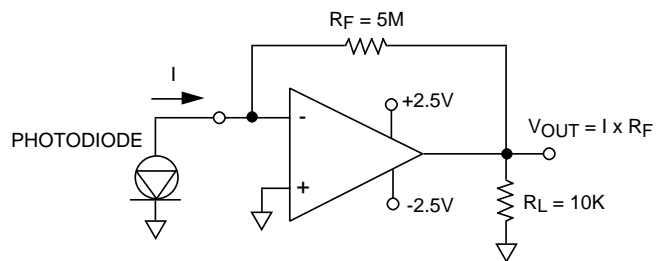
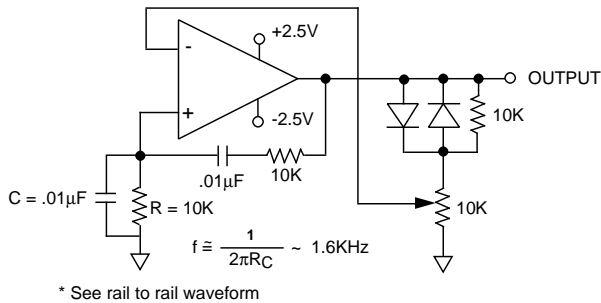

PHOTO DETECTOR CURRENT TO VOLTAGE CONVERTER



WIEN BRIDGE OSCILLATOR (RAIL-TO-RAIL) SINE WAVE GENERATOR



RAIL-TO-RAIL VOLTAGE COMPARATOR

