

M/A-COM Variable Voltage Gain Control Amplifier

0.8 - 2.0 GHz

Features

- Highly Integrated Variable Voltage Gain Control Amplifier
- Operates with 3.0 V to 5 V Supply Voltage
- Greater than 40 dB dynamic range
- High Output P_{1dB} : +17 dBm @ 3 V, 19 dBm @ 5V
- Low Cost 5 mm FQFP-N Package

Description

M/A-COM's AM55-0023 is a high performance, voltage controlled, variable gain amplifier. It has been designed for use in a broad range of applications including cellular base stations and mobile radio where AGC is required to increase system dynamic range.

The gain control operates best in the 900 MHz range and also has useable gain to 2.5 GHz. DC current is low at 160 mA at 3V bias and 200 mA at 5V bias. The package is a low cost MLF.

The AM55-0023 is fabricated using M/A-COM's 0.5 micron low noise GaAs MESFET process. The process features full passivation for performance and reliability.

Functional Block Diagram

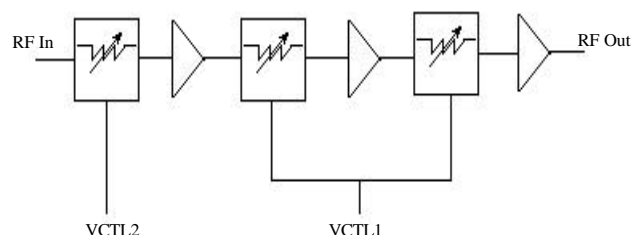

Ordering Information

Part Number	Package
AM55-0023	FQFP-N 5.0 mm Plastic Package
AM55-0023TR	Forward Tape and Reel ¹
AM55-0023RTR	Reverse Tape and Reel ¹
AM55-0023SMB	Sample Board

1. If specific reel size is required, consult factory for part number assignment.

Electrical Specifications $T_A = +25^\circ C$

Parameter	Test Conditions	Units	Min.	Typ.	Max.
Gain	Frequency = 0.9 GHz	dB	23	25	
	Frequency = 2.0 GHz	dB	10	12	
Attenuation Range	Frequency = 0.9 GHz	dB	40	44	
	Frequency = 2.0 GHz	dB	37	41	
I/P Return Loss	Frequency = 0.9 GHz	dB	14	17	
	Frequency = 2.0 GHz	dB	7	10	
O/P Return Loss	Frequency = 0.9 GHz	dB	11	14	
	Frequency = 2.0 GHz	dB	10	13	
Noise Figure (min attn)	Frequency = 0.9 GHz	dB		9	12
P_{1dB}	Max P_{1dB} when $V_{DDB1,2,3}$ at 5 V	dBm	14	18	
IMD	$V_{DDB} = 5 V$	dB	29	32	
	$V_{DDA} = 5 V$	dB	25	28	

Specifications subject to change without notice.

V 2.0

- North America: Tel. (800) 366-2266, Fax (800) 618-8883
- Asia/Pacific: Tel.+81-44-844-8296, Fax +81-44-844-8298
- Europe: Tel. +44 (1344) 869 595, Fax+44 (1344) 300 020

tyco / Electronics

M/A-COM

Visit www.macom.com for additional data sheets and product information.

Operating Instructions

Two pins, VCTL1 and VCTL2 control the attenuation function of this part. Varying these pins between 0 and 4.5 V controls the attenuation. *VCTL1 should be controlled first to avoid degrading the input match and noise figure until more attenuation is needed.* VCTL1 controls an attenuator with 30 dB of range and VCTL2 15dB of range.

The AM55-0023 has two sets of Vdd pins. VDDA1,2,3 and VDDDB1,2,3. VDDA should be supplied with 5 V. This voltage is internally stepped down to 3 V to reduce current consumption. If current consumption is not a concern OR only 3 V is available to the part then the VDDDB pins should be used. Using the VDDDB pins with 5 V will also give greater IP3/IMD performance (See graphs).

Note: When using one set of bias pins the other should be left open circuited.

Absolute Maximum Ratings¹

Parameter	Absolute Maximum
Input Power ²	+20 dBm
Operating Voltages ²	V _{DDA/B1,2,3} = +6 volts
Operating Temperature	-40 °C to +85 °C
Storage Temperature	-65 °C to +150 °C

1. Exceeding any one or combination of these limits may cause permanent damage.
2. Ambient Temperature (T_A) = +25°C

Pin Configuration

PIN No.	PIN Name	Description
1	Input	RF Input
2	NC	
3	NC	
4	NC	
5	VCTL2	Second Attenuation Control
6	NC	
7	NC	
8	NC	
9	VCTL1	First Attenuation Control
10	NC	
11	NC	
12	NC	
13	Output	RF Output
14	VDDDB3	Bias Pins
15	VDDA3	Bias Pins
16	VDDA2	Bias Pins
17	VDDDB2	Bias Pins
18	VDDDB1	Bias Pins
19	VDDA1	Bias Pins
20	NC	

Typical Performance Curves

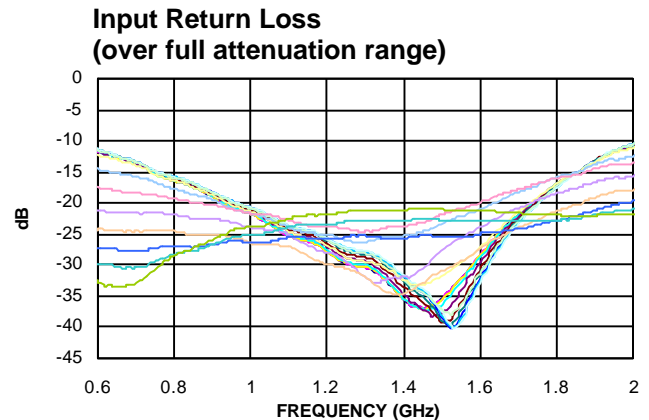
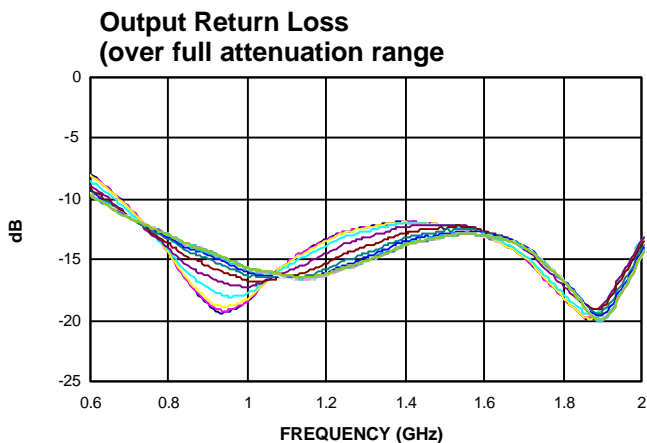

Specifications subject to change without notice.

- North America: Tel. (800) 366-2266, Fax (800) 618-8883
- Asia/Pacific: Tel.+81-44-844-8296, Fax +81-44-844-8298
- Europe: Tel. +44 (1344) 869 595, Fax+44 (1344) 300 020

Visit www.macom.com for additional data sheets and product information.

Typical Performance Curves (Cont'd)

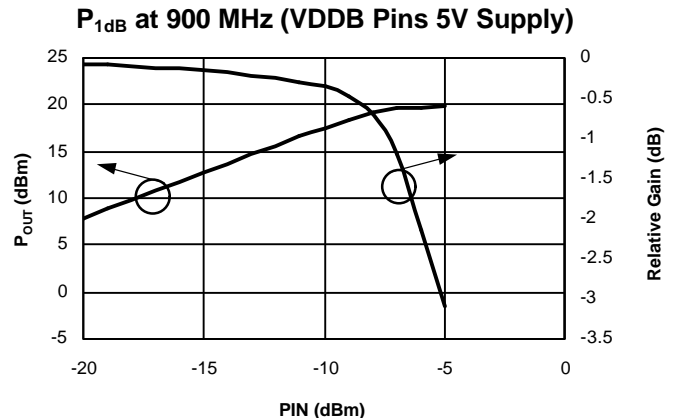
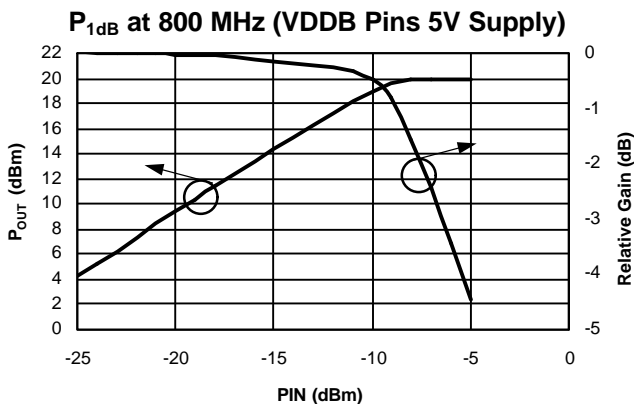
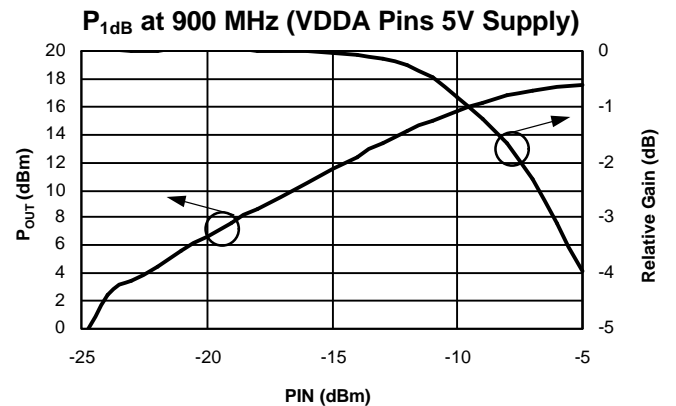
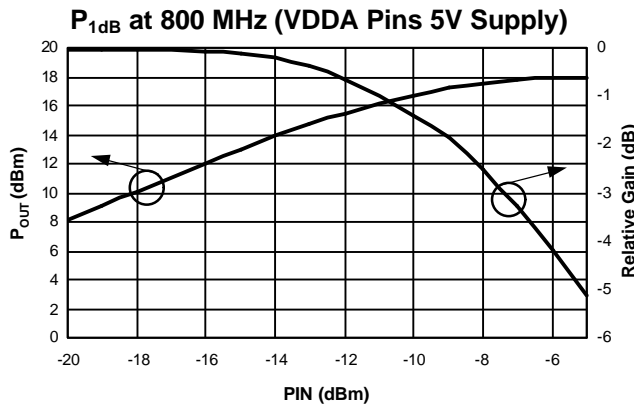
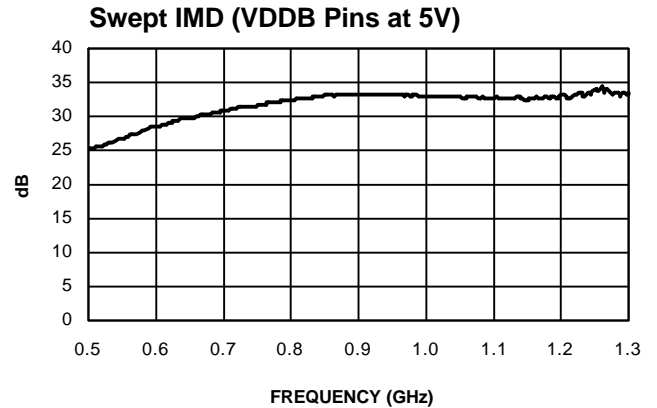
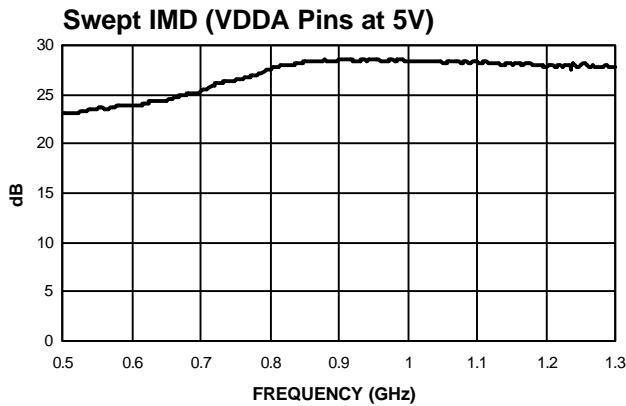
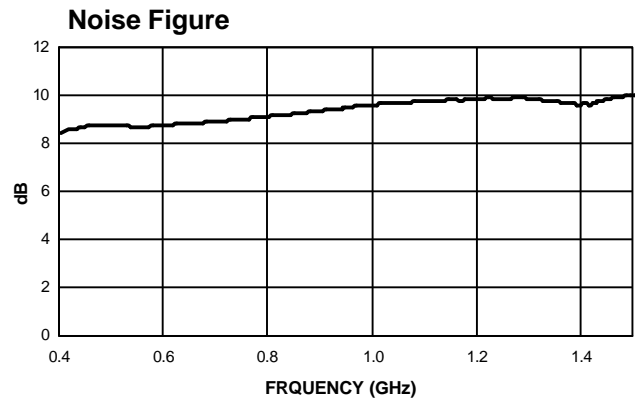
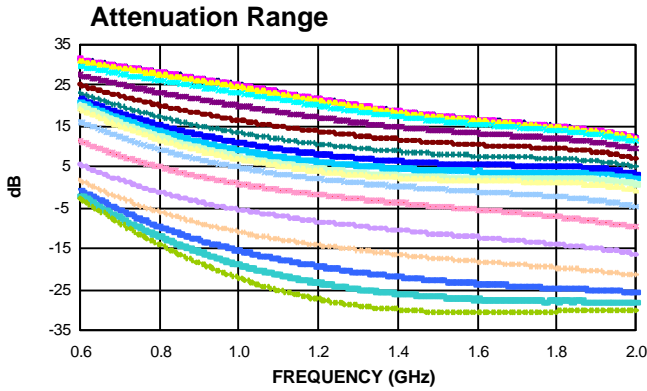

Specifications subject to change without notice.

V.2.0

- North America: Tel. (800) 366-2266, Fax (800) 618-8883
- Asia/Pacific: Tel.+81-44-844-8296, Fax +81-44-844-8298
- Europe: Tel. +44 (1344) 869 595, Fax+44 (1344) 300 020

Visit www.macom.com for additional data sheets and product information.

5 mm FQFP-N - 20¹

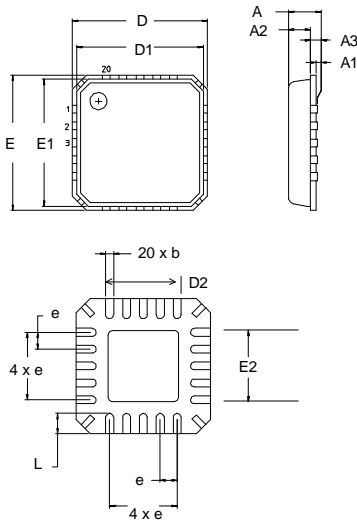

1. See JEDEC MO-220A VHHC for additional dimensional and tolerance information

5 mm FQFP-N - 20

Dim.	Measurement (mm)		
	Min.	Nom.	Max.
A	0.80	0.90	1.00
A1	0	0.02	0.05
A2	0	0.65	1.00
A3		0.25 ref.	
b	0.23	0.30	0.38
D		5.00 basic	
D1		4.75 basic	
D2	1.25	2.70	3.25
e		0.65 basic	
E		5.00 basic	
E1		4.75 basic	
E2	1.25	2.70	3.25
L	0.35	0.55	0.75

External Components^{1, 2}

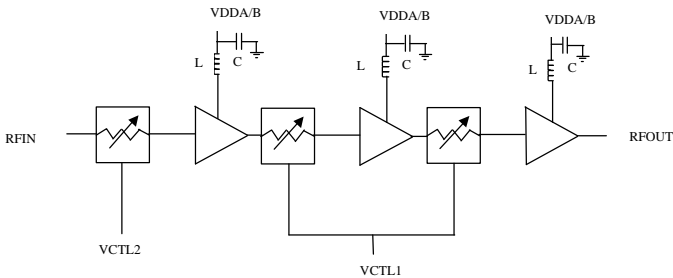

Component	Value
L	68nH
C	100pF

1. See Operating Instructions for details on VDD pins.
2. Requires 6 external components.

Sample Board

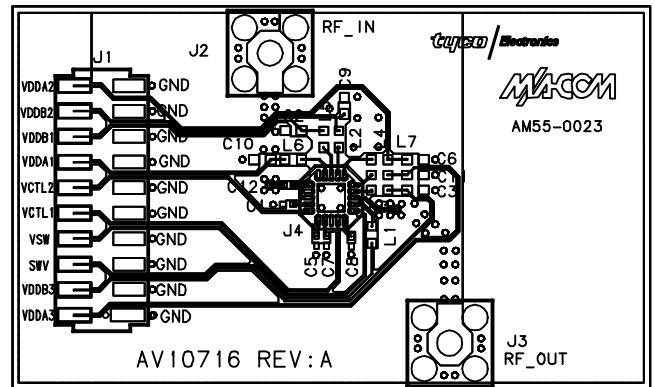

Specifications subject to change without notice.

- North America: Tel. (800) 366-2266, Fax (800) 618-8883
- Asia/Pacific: Tel.+81-44-844-8296, Fax +81-44-844-8298
- Europe: Tel. +44 (1344) 869 595, Fax+44 (1344) 300 020

Visit www.macom.com for additional data sheets and product information.