



### ■ General Description

The AME8841 linear regulator features low quiescent current (30µA typ.) with low dropout voltage, making it ideal for battery applications. The space-saving SO-8 package is attractive for "Pocket" and "Hand Held" applications.

These rugged devices have both Thermal Shutdown, and Current Fold-back to prevent device failure under the "Worst" of operating conditions.

The AME8841 is stable with an output capacitance of 2.2µF or greater.

### ■ Features

- Very Low Dropout Voltage
- Guaranteed 600mA Output
- Accurate to within 1.5%
- 30µA Quiescent Current
- Over-Temperature Shutdown
- Current Limiting
- Short Circuit Current Fold-back
- Power-Saving Shutdown Mode
- Space-Saving SO-8 Package
- Many fixed output voltages available
- Low Temperature Coefficient

### ■ Applications

- Instrumentation
- Portable Electronics
- Wireless Devices
- Cordless Phones
- PC Peripherals
- Battery Powered Widgets
- Electronic Scales

### ■ Pin Configuration

SO-8 Top View

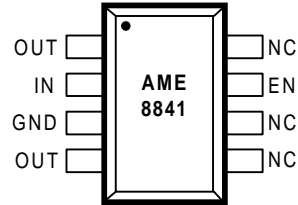

### ■ Functional Block Diagram

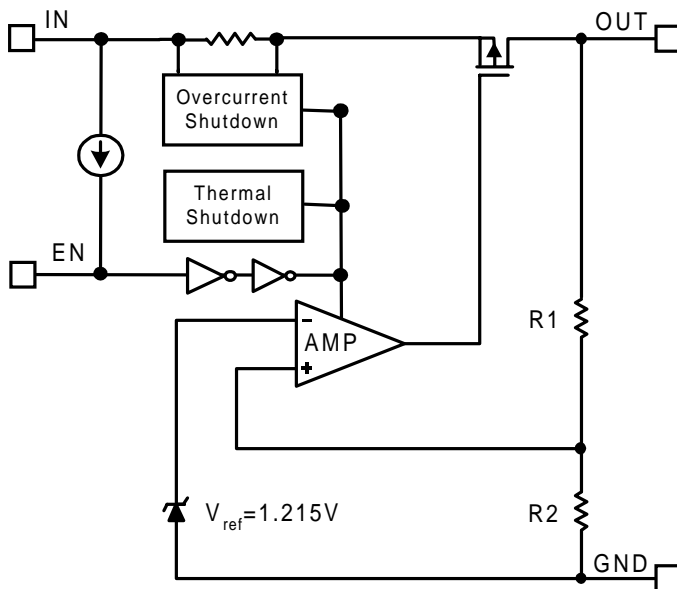

### ■ Typical Application

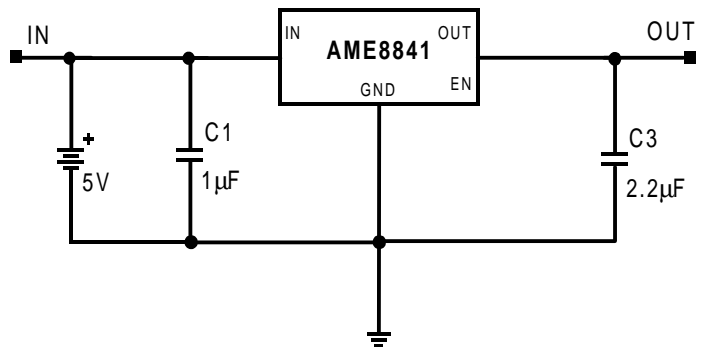



### ■ Absolute Maximum Ratings:

Parameter	Maximum	Unit
Input Voltage	8	V
Output Current	$P_D / (V_{IN} - V_O)$	A
Input, Output Voltage	GND - 0.3 to $V_{IN} + 0.3$	V
ESD Classification	B	

### ■ Recommended Operating Conditions:

Parameter	Rating	Unit
Ambient Temperature Range	-40 to +85	°C
Junction Temperature	-40 to +125	°C

### ■ Thermal Paramters

Parameter	Maximum	Unit
Thermal Resistance ( $\theta_{ja}$ )	123.7	°C / W
Internal Power Dissipation ( $P_D$ ) ( $\Delta T = 100^\circ\text{C}$ )	810	mW
Maximum Junction Temperature	150	°C
Maximum Lead Temperature ( 10 Sec)	300	°C

*Caution: Stress above the listed absolute rating may cause permanent damage to the device*



### ■ Ordering Information

Part Number	Marking	Output	Package	Operating Temp.
AME8841AEHA	8841 AEHA yyww	3.3V	SO-8	-40°C to +85°C
AME8841BEHA	8841 BEHA yyww	3.0V	SO-8	-40°C to +85°C
AME8841CEHA	8841 CEHA yyww	2.8V	SO-8	-40°C to +85°C
AME8841DEHA	8841 DEHA yyww	2.5V	SO-8	-40°C to +85°C
AME8841EEHA	8841 EEHA yyww	3.8V	SO-8	-40°C to +85°C
AME8841FEHA	8841 FEHA yyww	3.6V	SO-8	-40°C to +85°C
AME8841GEHA	8841 GEHA yyww	3.5V	SO-8	-40°C to +85°C
AME8841HEHA	8841 HEHA yyww	2.7V	SO-8	-40°C to +85°C
AME8841IEHA	8841 IEHA yyww	3.4V	SO-8	-40°C to +85°C
AME8841JEHA	8841 JEHA yyww	2.85V	SO-8	-40°C to +85°C
AME8841KEHA	8841 KEHA yyww	3.7V	SO-8	-40°C to +85°C
AME8841LEHA	8841 LEHA yyww	1.5V	SO-8	-40°C to +85°C
AME8841MEHA	8841 MEHA yyww	1.8V	SO-8	-40°C to +85°C
AME8841NEHA	8841 NEHA yyww	2.9V	SO-8	-40°C to +85°C
AME8841OEHA	8841 OEHA yyww	3.1V	SO-8	-40°C to +85°C
AME8841REHA	8841 REHA yyww	2.65V	SO-8	-40°C to +85°C

Please consult AME sales office or authorized Rep./Distributor for other output voltage and package type availability.



## ■ Electrical Specifications

$T_A = 25^\circ C$  unless otherwise noted

Parameter	Symbol	Test Condition	Min	Typ	Max	Units	
Input Voltage	$V_{IN}$		Note 1		7	V	
Output Voltage Accuracy	$V_O$	$I_O=1mA$	-1.5		1.5	%	
Dropout Voltage	$V_{DROPOUT}$	$I_O=600mA$ $V_O=V_{ONOM}-2.0\%$	$1.4V < V_{O(NOM)} \leq 2.0V$	See chart	1400	mV	
			$2.0V < V_{O(NOM)} \leq 2.8V$		800		
			$2.8V < V_{O(NOM)}$		600		
Output Current	$I_O$	$V_O > 1.2V$	600			mA	
Current Limit	$I_{LIM}$	$V_O > 1.2V$	600	800		mA	
Short Circuit Current	$I_{SC}$	$V_O < 0.8V$		300	600	mA	
Quiescent Current	$I_Q$	$I_O=0mA$		30	50	$\mu A$	
Ground Pin Current	$I_{GND}$	$I_O=1mA$ to 600mA		30	50	$\mu A$	
Line Regulation	$REG_{LINE}$	$I_O=5mA$ $V_{IN}=V_O+1$ to $V_O+2$	$V_O < 2.0V$	-0.15		0.15	%
			$4.0V > V_O \geq 2.0V$	-0.1	0.02	0.1	%
			$V_O \geq 4.0V$	-0.4		0.4	%
Over Temperature Shutdown	OTS			150		$^\circ C$	
Over Temperature Hysteresis	OTH			30		$^\circ C$	
$V_O$ Temperature Coefficient	TC			30		ppm/ $^\circ C$	
Power Supply Rejection	PSRR	$I_O=100mA$ $C_O=2.2\mu F$	$f=1kHz$		50	dB	
			$f=10kHz$		20		
			$f=100kHz$		15		
Output Voltage Noise	eN	$f=10Hz$ to 100kHz $I_O=10mA, C_{BYP}=0\mu F$		30		mVrms	
EN Input Threshold	$V_{EH}$	$V_{IN}=2.7V$ to 7V	2.0		$V_{in}$	V	
	$V_{EL}$	$V_{IN}=2.7V$ to 7V	0		0.4	V	
EN Input Bias Current	$I_{EH}$	$V_{EN}=V_{IN}, V_{IN}=2.7V$ to 7V			0.1	$\mu A$	
	$I_{EL}$	$V_{EN}=0V, V_{IN}=2.7V$ to 7V			0.5	$\mu A$	
Shutdown Supply Current	$I_{SD}$	$V_{IN}=5V, V_O=0V, V_{EN}<V_{EL}$		0.5	1	$\mu A$	

Note1:  $V_{IN(min)}=V_{OUT}+V_{DROPOUT}$



### ■ Detailed Description

The AME8841 family of CMOS regulators contain a PMOS pass transistor, voltage reference, error amplifier, over-current protection, and thermal shutdown.

The P-channel pass transistor receives data from the error amplifier, over-current shutdown, and thermal protection circuits. During normal operation, the error amplifier compares the output voltage to a precision reference. Over-current and Thermal shutdown circuits become active when the junction temperature exceeds 150°C, or the current exceeds 600mA. During thermal shutdown, the output voltage remains low. Normal operation is restored when the junction temperature drops below 110°C.

The AME8841 switches from voltage mode to current mode when the load exceeds the rated output current. This prevents over-stress. The AME8841 also incorporates current foldback to reduce power dissipation when the output is short circuited. This feature becomes active when the output drops below 0.8 volts, and reduces the current flow by 65%. Full current is restored when the voltage exceeds 0.8 volts.

### ■ External Capacitors

The AME8841 is stable with an output capacitor to ground of 2.2 $\mu$ F or greater. Ceramic capacitors have the lowest ESR, and will offer the best AC performance. Conversely, Aluminum Electrolytic capacitors exhibit the highest ESR, resulting in the poorest AC response. Unfortunately, large value ceramic capacitors are comparatively expensive. One option is to parallel a 0.1 $\mu$ F ceramic capacitor with a 10 $\mu$ F Aluminum Electrolytic. The benefit is low ESR, high capacitance, and low overall cost.

A second capacitor is recommended between the input and ground to stabilize  $V_{in}$ . The input capacitor should be at least 0.1 $\mu$ F to have a beneficial effect.

All capacitors should be placed in close proximity to the pins. A "Quiet" ground termination is desirable. This can be achieved with a "Star" connection.

### ■ Enable

The Enable pin normally floats high. When actively, pulled low, the PMOS pass transistor shuts off, and all internal circuits are powered down. In this state, the quiescent current is less than 1 $\mu$ A. This pin behaves much like an electronic switch.

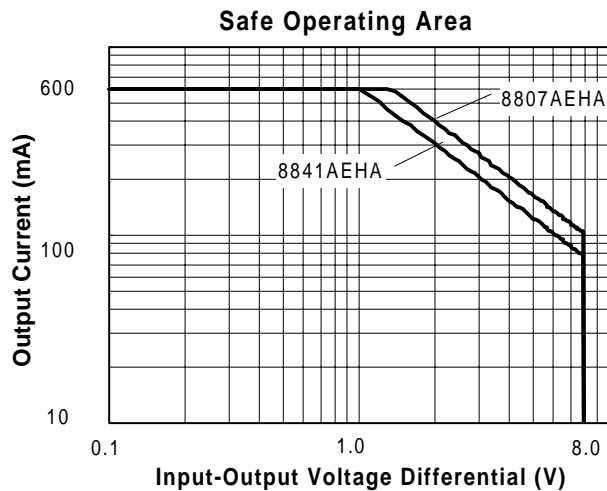
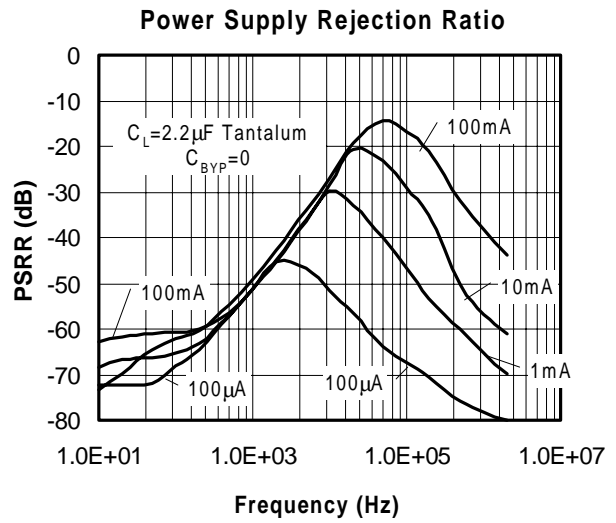
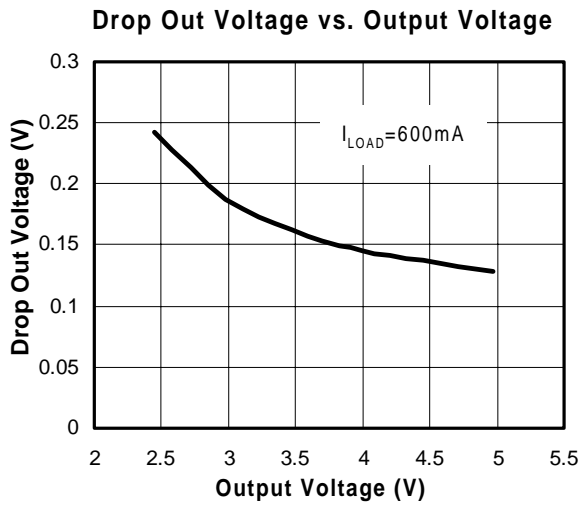
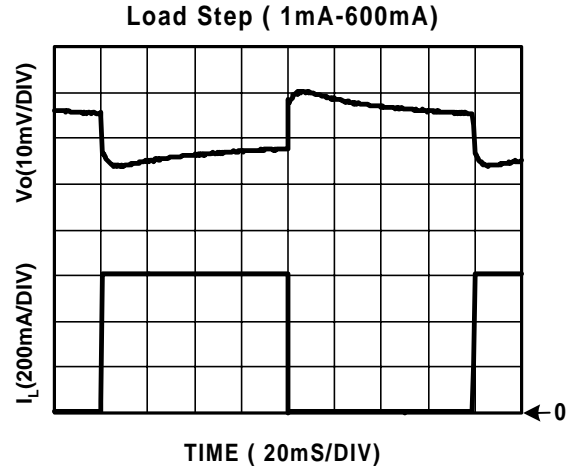
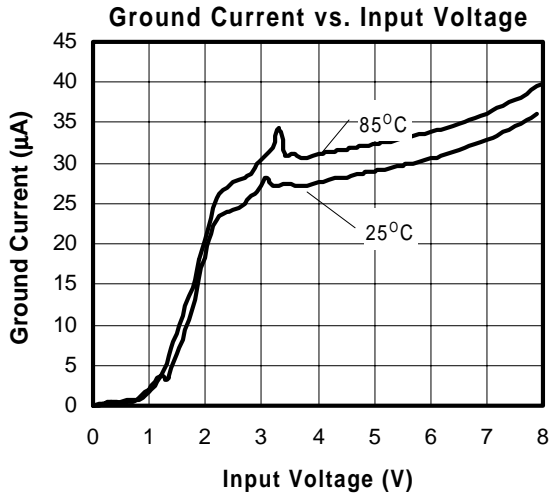



### Noise Measurement

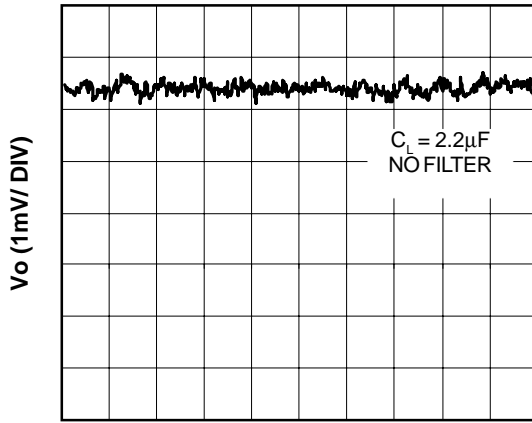

TIME (20ms/DIV)

### Overtemperature Shutdown

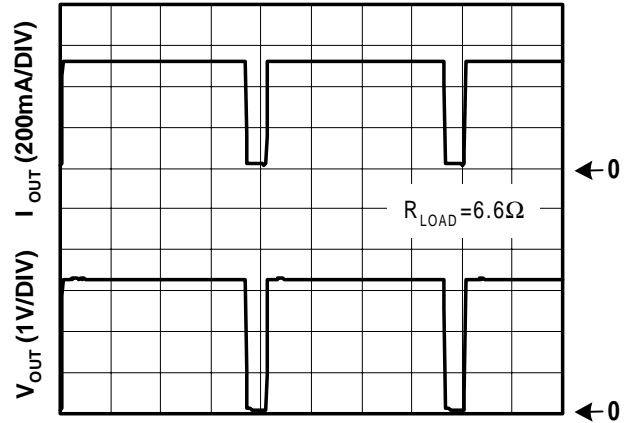

TIME (0.5Sec/DIV)

### Current Limit Response

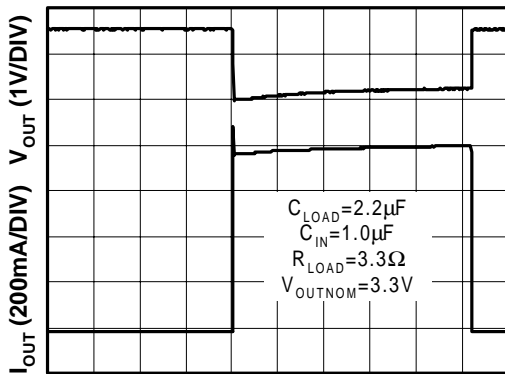

TIME (2ms/DIV)

### Short Circuit Response

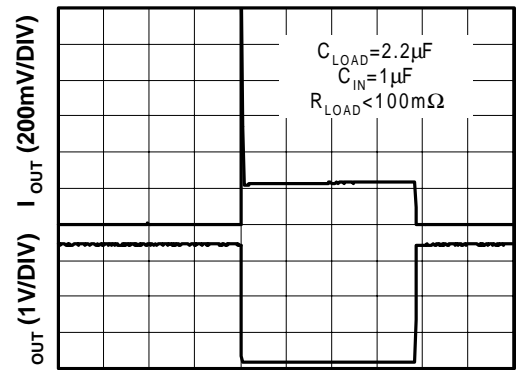

TIME (2ms/DIV)

### Chip Enable Transient Response

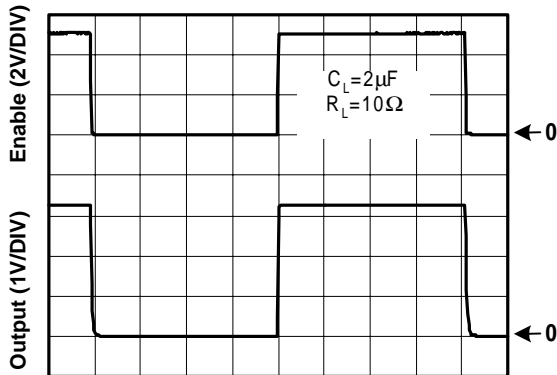

TIME (1ms/DIV)

### Line Transient Response

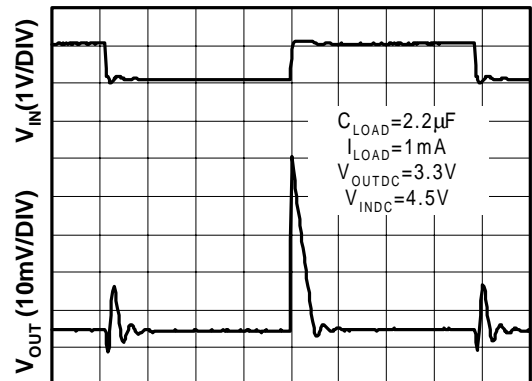

TIME (200ms/DIV)



Quiescent Current vs.Temp.

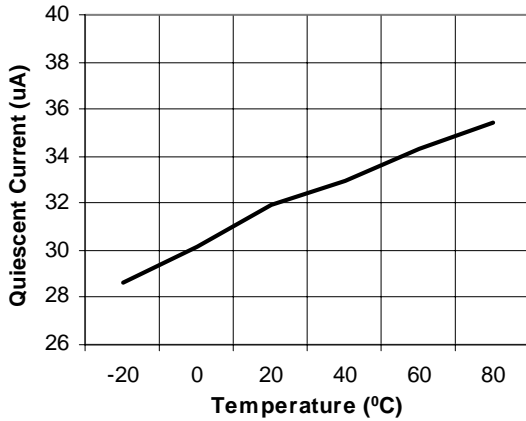

EN pin vs. Temp.

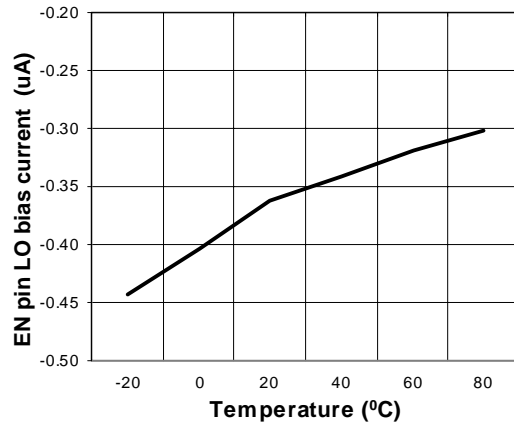

Shut Down Current vs. Temp.

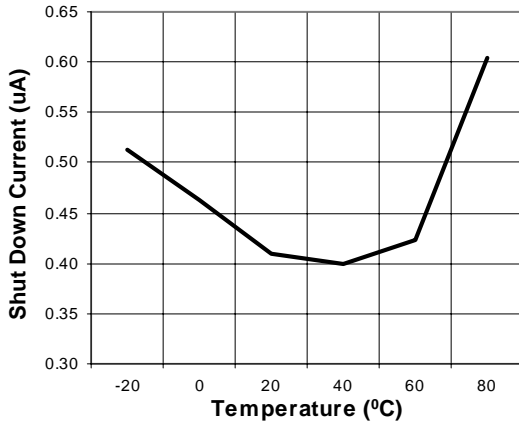

Dropout Voltage vs. Temp.

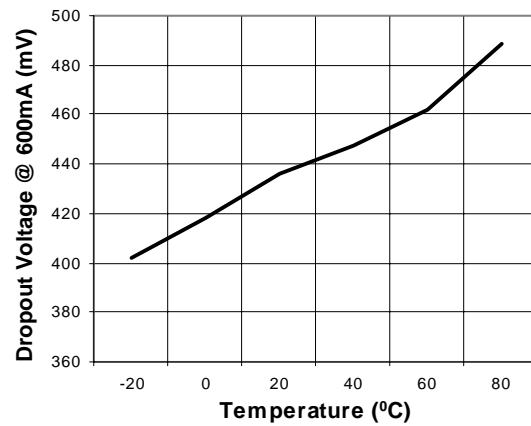

Vout vs. Temp.

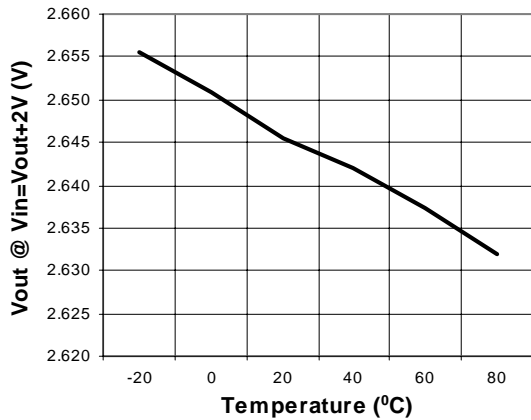

Load Regulation vs. Temp.

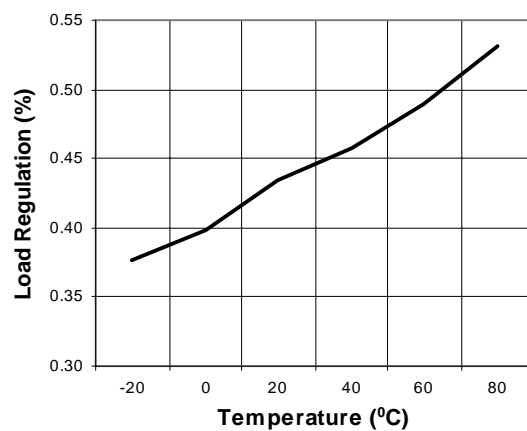





■ Package Dimension

SO-8

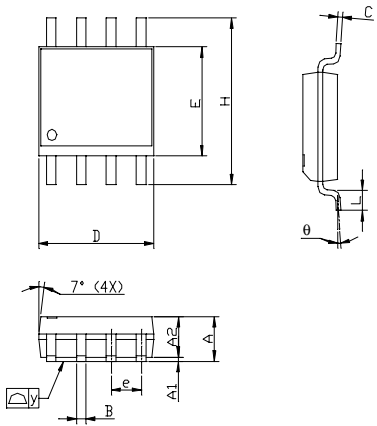

SYMBOLS	MILLIMETERS		INCHES	
	MIN	MAX	MIN	MAX
A	1.35	1.75	0.053	0.069
A <sub>1</sub>	0.10	0.25	0.004	0.010
A <sub>2</sub>	—	—	—	—
B	0.33	0.51	0.013	0.020
C	0.19	0.25	0.007	0.010
D	4.80	5.00	0.189	0.1970
E	3.80	4.00	0.150	0.157
e	—	—	—	—
H	5.80	6.20	0.228	0.244
L	0.40	1.27	0.016	0.050
y	—	0.10		0.004
θ	0°	8°	0°	8°



**www.analogmicro.com**  
**E-Mail: info@analogmicro.com**

Life Support Policy:

These products of Analog Microelectronics, Inc. are not authorized for use as critical components in life-support devices or systems, without the express written approval of the president of Analog Microelectronics, Inc.

Analog Microelectronics, Inc. reserves the right to make changes in the circuitry and specifications of its devices and advises its customers to obtain the latest version of relevant information.

© Analog Microelectronics, Inc. , August 2001

Document: 2006-DS8841-C

**Corporate Headquarters**  
**Analog Microelectronics, Inc.**

3100 De La Cruz Blvd. Suite 201  
Santa Clara, CA. 95054-2046  
Tel : (408) 988-2388  
Fax: (408) 988-2489

**Asia Pacific Headquarters**  
**AME, Inc.**

2F, NO. 187 Kang-Chien Road, Nei-Hu Dist.,  
Taipei 114, Taiwan, R.O.C.  
Tel : 886 2 2627-8687  
Fax: 886 2 2659-2989