

AMMC-5023

23 GHz Low Noise Amplifier (21.2 – 26.5 GHz)

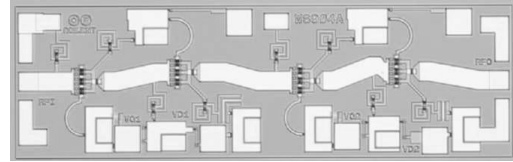

Data Sheet



Chip Size: 1880 x 600 μm (74 x 23.6 mils)
Chip Size Tolerance: $\pm 10 \mu\text{m}$ (± 0.4 mils)
Chip Thickness: $100 \pm 10 \mu\text{m}$ (4 ± 0.4 mils)
Pad Dimensions: 80 x 80 μm (3.1 x 3.1 mils), or larger

Description

Avago's AMMC-5023 is a high gain, low noise amplifier that operates from 21 GHz to over 30 GHz. By eliminating the complex tuning and assembly processes typically required by hybrid (discrete-FET) amplifiers, the AMMC-5023 is a cost-effective alternative in both 21.2–23.6 GHz and 24.5–26.5 GHz communications receivers. The device has good input and output match to 50 Ohm and is unconditionally stable to more than 40 GHz. The backside of the chip is both RF and DC ground. This helps simplify the assembly process and reduces assembly related performance variations and costs. It is fabricated in a PHEMT process to provide exceptional noise and gain performance. For improved reliability and moisture protection, the die is passivated at the active areas.

Features

- Frequency range: 21.2 – 26.5 GHz
- High gain: 23 dB
- Low noise figure: 2.3 dB
- Input and output return loss: >10 dB
- Single supply bias: 5 volts, 28 mA
- Optional bias adjust

Applications

- Digital Radio Communication Systems (21.2–23.6 GHz and 24.5–26.5 GHz)
- Any narrow band application within 21 – 26 GHz
- 24.1 GHz collision avoidance
- Front-end gain stage

Absolute Maximum Ratings^[1]

Symbol	Parameters/Conditions	Units	Min.	Max.
V_{D1}, V_{D2}	Drain Supply Voltage	V		8
V_{G1}, V_{G2}	Gate Supply Voltage	V	0.4	2
I_{D1}	Drain Supply Current	mA		35
I_{D2}	Drain Supply Current	mA		35
P_{in}	RF Input Power	dBm		15
T_{ch}	Channel Temperature	$^{\circ}\text{C}$		+150
T_b	Operating Backside Temperature	$^{\circ}\text{C}$	-55	+140
T_{stg}	Storage Temperature	$^{\circ}\text{C}$	-65	+165
T_{max}	Max. Assembly Temp (60 sec max)	$^{\circ}\text{C}$		+300

Notes:

1. Absolute maximum ratings for continuous operation unless otherwise noted.

AMMC-5023 DC Specifications/Physical Properties^[1]

Symbol	Parameters and Test Conditions	Units	Min.	Typ.	Max.
V_{D1}, V_{D2}	Recommended Drain Supply Voltage	V	3	5	7
V_{G1}, V_{G2}	Gate Supply Voltage ^[2] ($V_{D1} \leq V_{D1(max)}$, $V_{D2} \leq V_{D2(max)}$)	V		0.8	
I_{D1}, I_{D2}	Input and Output Stage Drain Supply Current ($V_{G1} = V_{G2} = \text{Open}$, $V_{D1} = V_{D2} = 5\text{ V}$)	mA		14	
$I_{D1} + I_{D2}$	Total Drain Supply Current ($V_{G1} = V_{G2} = \text{Open}$, $V_{D1} = V_{D2} = 5\text{ V}$)	mA	13	28	35
θ_{ch-b}	Thermal Resistance ^[3] (Backside temperature, $T_b = 25^\circ\text{C}$)	$^\circ\text{C}/\text{W}$		44	

Notes:

1. Backside ambient operating temperature $T_A = 25^\circ\text{C}$ unless otherwise noted.
2. Open circuit voltage at V_{G1} and V_{G2} when V_{D1} and V_{D2} are 5 Volts.
3. Channel-to-backside Thermal Resistance (θ_{ch-b}) = $66^\circ\text{C}/\text{W}$ at $T_{channel} (T_c) = 150^\circ\text{C}$ as measured using the liquid crystal method. Thermal Resistance at backside temperature (T_b) = 25°C calculated from measured data.

RF Specifications^[4]

($V_{G1} = V_{G2} = \text{Open}$, $V_{D1} = V_{D2} = 5\text{V}$, $I_{D1} + I_{D2} = 28\text{ mA}$, $Z_{in} = Z_0 = 50\Omega$)

Symbol	Parameters and Test Conditions	Units	21.2 – 23.6 GHz			24.5 – 26.5 GHz		
			Min.	Typ.	Max.	Min.	Typ.	Max.
$ S_{21} ^2$	Small-signal Gain	dB	21	23.6	28	17	19	25
$\Delta S_{21} ^2$	Small-signal Gain Flatness	dB		± 1.5			± 1.2	
RL_{in}	Input Return Loss	dB	10	12		10	11.5	
RL_{out}	Output Return Loss	dB	9	12		10	17	
$ S_{12} ^2$	Isolation	dB	40	50		40	43	
P_{-1dB}	Output Power @ 1 dB Gain Compression $f = 23\text{ GHz}$	dBm		9.5			10	
P_{sat}	Saturated Output Power (@ 3 dB Gain Compression)	dBm		10.5			11.5	
OIP3	Output 3 rd Order Intercept Point, $Rf_{in1} = Rf_{in2} = -20\text{ dBm}$, $\Delta f = 2\text{ MHz}$	dB	22.4 GHz	18		25.5 GHz	24	
NF	Noise Figure	dB	22 GHz	2.3	2.8	25 GHz	2.3	2.8

Note:

4. 100% on-wafer RF test is done at frequency = 21.2, 22.4, 23.6, 24.5, 25.5 and 26.5 GHz, except as noted.

AMMC-5023 Typical Performance

($T_{\text{chuck}} = 25^{\circ}\text{C}$, $V_{D1} = V_{D2} = 5\text{V}$, $V_{G1} = V_{G2} = \text{Open}$, $Z_0 = 50\Omega$)

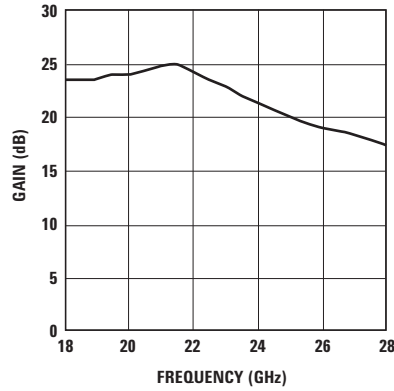

Figure 1. Gain.

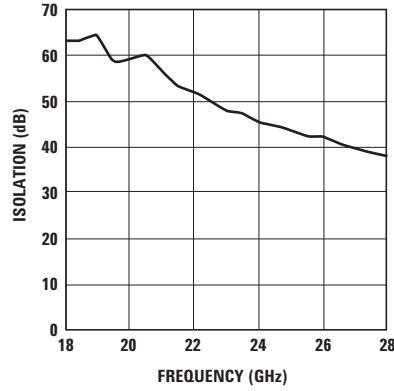

Figure 2. Isolation.

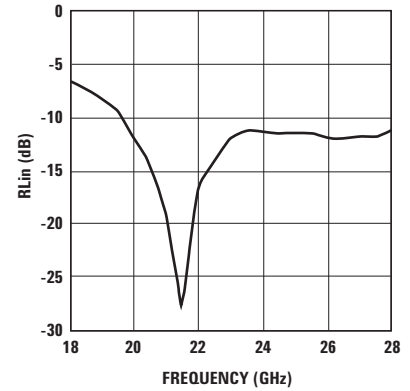

Figure 3. Input Return Loss.

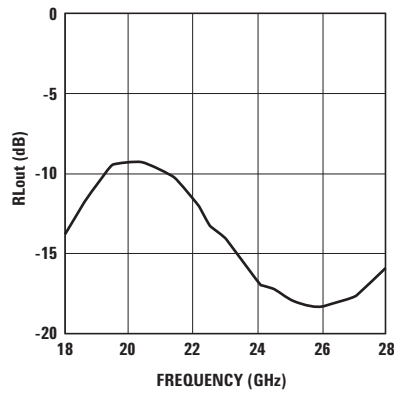

Figure 4. Output Return Loss.

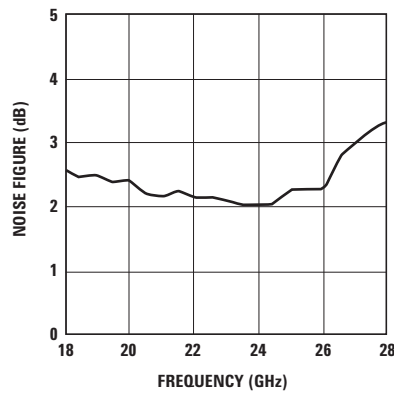

Figure 5. Noise Figure.

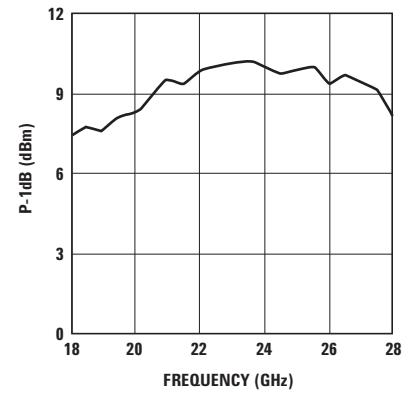

Figure 6. Output Power at 1dB Gain Compression.

AMMC-5023 Typical Performance vs. Supply Voltage

($T = 25^{\circ}\text{C}$, $V_{D1} = V_{D2} = V_{DD}$, $V_{G1} = V_{G2} = \text{Open}$, $Z_0 = 50\Omega$)

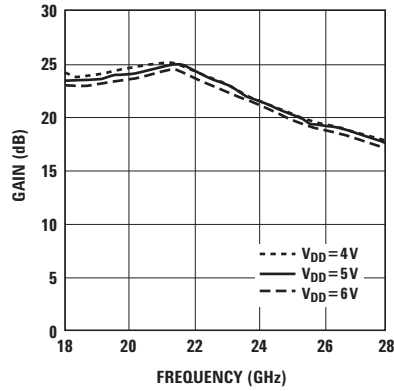

Figure 7. Gain and Voltage.

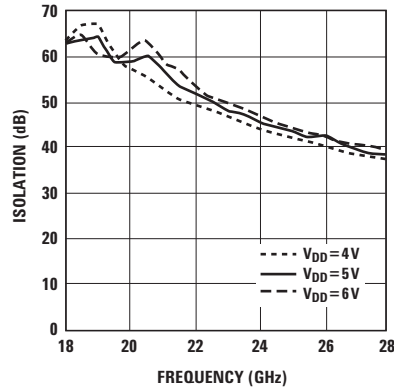

Figure 8. Isolation and Voltage.

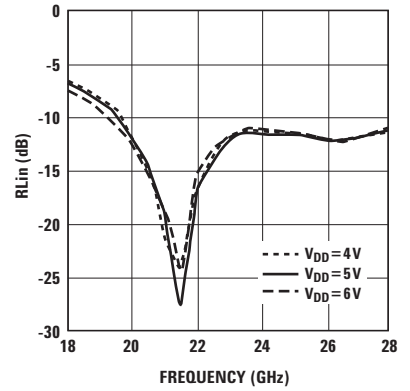

Figure 9. Input Return Loss and Voltage.

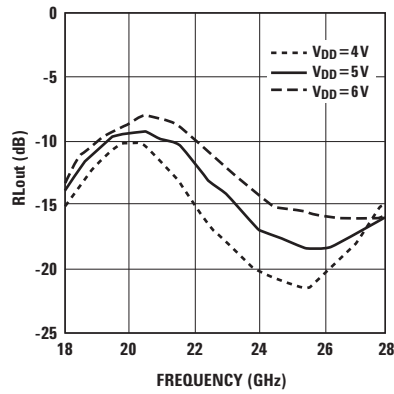

Figure 10. Output Return Loss and Voltage.

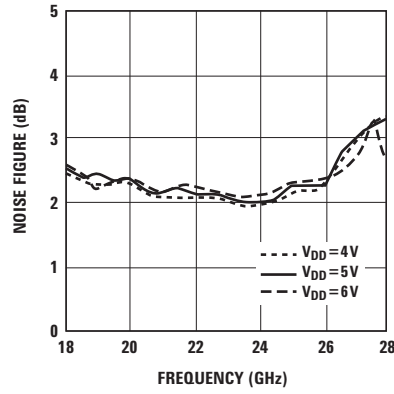

Figure 11. Noise Figure and Voltage.

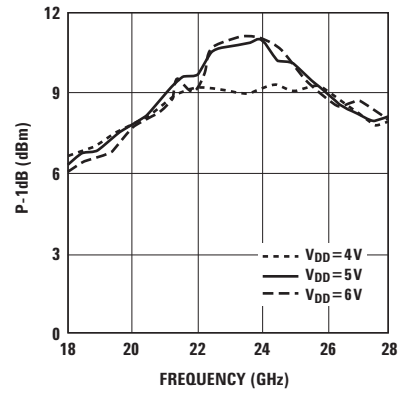

Figure 12. P-1dB and Voltage.

AMMC-5023 Typical Performance vs. Temperature

($V_{D1} = V_{D2} = V_{DD} = 5V$, $V_{G1} = V_{G2} = \text{Open}$, $Z_0 = 50\Omega$)

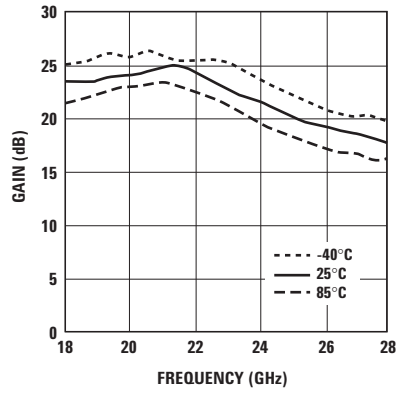

Figure 13. Gain and Temperature.

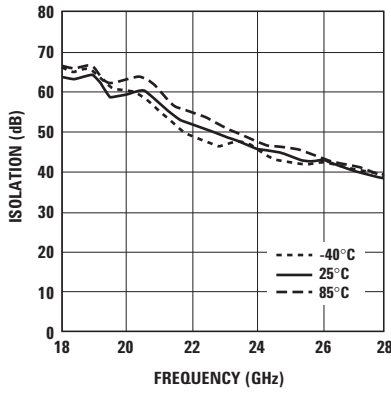

Figure 14. Isolation and Temperature.

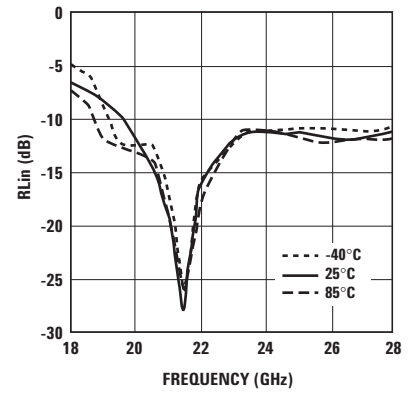

Figure 15. Input Return Loss and Temperature.

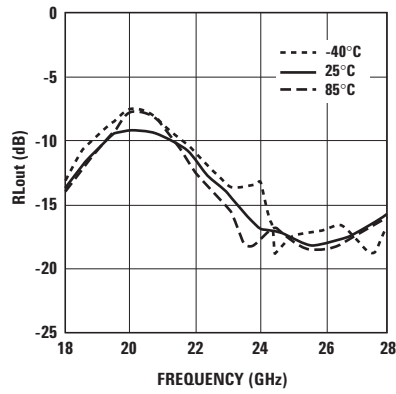

Figure 16. Output Return Loss and Temperature.

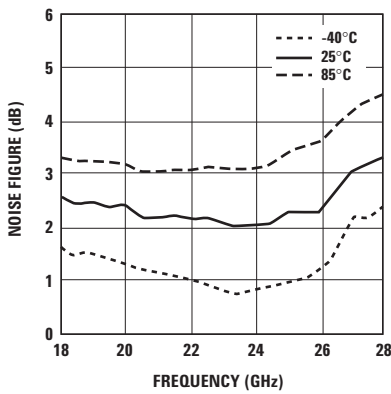

Figure 17. Noise Figure and Temperature.

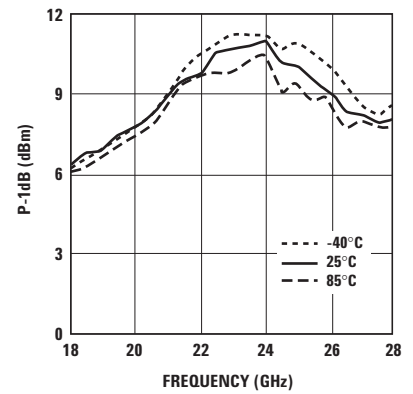

Figure 18. P-1dB and Temperature.

AMMC-5023 Typical Scattering Parameters^[1] ($T_c = 25^\circ\text{C}$, $V_{D1} = V_{D2} = 5\text{V}$, $I_{dd} = 28\text{mA}$, $V_{G1} = V_{G2} = \text{Open}$)

Freq. GHz	S_{11}			S_{12}			S_{21}			S_{22}		
	dB	Mag	Phase	dB	Mag	Phase	dB	Mag	Phase	dB	Mag	Phase
18	-6.813	0.4564	74.519	-57.94	0.0013	1.7405	23.206	14.464	122.15	-13.57	0.2096	51.531
18.2	-7.202	0.4364	74.66	-59.98	0.001	-26.99	23.203	14.459	111.97	-13.66	0.2076	-73.76
18.4	-7.266	0.4332	72.588	-60.22	0.001	124.05	23.114	14.312	101.1	-12.57	0.2354	165.76
18.6	-7.644	0.4148	70.858	-62.22	0.0008	17.763	23.114	14.313	91.174	-11.74	0.2588	163.66
18.8	-7.815	0.4067	67.349	-58.93	0.0011	100.07	23.202	14.457	81.167	-11.64	0.2618	157.71
19	-8.46	0.3776	65.232	-61.93	0.0008	76.42	23.282	14.592	71.291	-10.45	0.3002	152.53
19.2	-8.502	0.3758	62.276	-63.28	0.0007	40.997	23.382	14.76	61.218	-10.44	0.3006	150.28
19.4	-9.293	0.343	56.815	-57.84	0.0013	100.86	23.582	15.104	50.894	-9.703	0.3272	141.82
19.6	-10.62	0.2943	51.64	-53.14	0.0022	60.218	23.787	15.464	39.572	-8.943	0.3572	139.34
19.8	-11.39	0.2694	54.737	-55.77	0.0016	22.448	23.659	15.239	29.26	-9.414	0.3383	129.99
20	-12.13	0.2474	53.651	-57.89	0.0013	1.7795	23.735	15.372	20.239	-8.923	0.358	126.19
20.2	-12.77	0.23	52.385	-60.66	0.0009	-42.99	23.882	15.635	10.031	-9.317	0.3421	123.37
20.4	-13.69	0.2067	49.224	-57.48	0.0013	-58.99	23.975	15.803	0.2045	-8.817	0.3624	114.62
20.6	-14.92	0.1795	46.249	-54.44	0.0019	-57.86	24.1	16.033	-9.704	-8.971	0.356	111.84
20.8	-16.83	0.1441	42.376	-56.15	0.0016	-40.83	24.412	16.618	-18.13	-9.29	0.3432	103.37
21	-19.11	0.1108	43.556	-53.47	0.0021	-53.53	24.479	16.748	-28.97	-9.167	0.3481	98.097
21.2	-23.18	0.0693	33.667	-57.14	0.0014	-51.56	24.705	17.19	-39.82	-10.07	0.3138	94.38
21.4	-30.15	0.0311	43.731	-55.04	0.0018	-53.75	24.755	17.288	-52.67	-10.209	0.3087	86.525
21.6	-20.59	0.0934	155.16	-52.25	0.0024	-67.58	24.427	16.648	-64.69	-10.54	0.2971	83.119
21.8	-17.93	0.1269	156.15	-51.09	0.0028	-88.01	24.235	16.284	-75.32	-11.06	0.2798	74.893
22	-15.74	0.1634	148.96	-54.03	0.002	-110.5	23.892	15.654	-84.97	-11	0.2818	75.567
22.2	-14.66	0.185	147.58	-48.57	0.0037	-108.8	23.656	15.233	-95.11	-11.99	0.2513	68.795
22.4	-13.94	0.201	142.03	-48.93	0.0036	-108.6	23.362	14.727	-104.6	-11.98	0.2518	61.88
22.6	-13.22	0.2184	142.09	-48.25	0.0039	-110	23.209	14.469	-113.7	-12.98	0.2243	62.905
22.8	-12.04	0.2499	138.22	-47.36	0.0043	-124.1	22.914	13.986	-124.1	-13.6	0.2089	55.353
23	-11.82	0.2565	133.62	-47.42	0.0043	-127.7	22.593	13.478	-132.6	-13.61	0.2086	59.509
23.2	-11.7	0.2601	130.32	-46.06	0.005	-134.4	22.312	13.05	-141.2	-14.94	0.179	53.623
23.4	-11.46	0.2672	129.24	-46.7	0.0046	-140.5	22.015	12.611	-146	-14.13	0.1965	50.5
23.6	-11.18	0.276	125.92	-46	0.005	-148.6	21.767	12.256	-154.2	-15.3	0.1718	54.919
23.8	-11.22	0.2749	124.18	-45.25	0.0055	-145.8	21.399	11.747	-161.7	-15.67	0.1646	41.768
24	-11.3	0.2724	122.88	-45.1	0.0056	-153.6	21.206	11.49	-169	-15.63	0.1654	49.105
24.2	-11.09	0.2789	122.15	-44.25	0.0061	-155.4	20.921	11.119	94.004	-16.94	0.1423	38.655
24.4	-11.32	0.2717	119.68	-44.3	0.0061	-167.3	20.626	10.748	170.24	-15.98	0.1589	37.913
24.6	-11.38	0.2698	118.72	-43.4	0.0068	-171.1	20.347	10.407	163.06	-16.8	0.1445	40.066
24.8	-11.41	0.269	118.3	-43.43	0.0067	-71.2	20.102	10.118	156.05	-16.7	0.1463	22.655
25	-11.62	0.2625	117.04	-43.54	0.0067	137.17	19.854	9.8331	149.07	-16.85	0.1436	28.818
25.2	-11.89	0.2544	116.86	-42.29	0.0077	133.77	19.696	9.6559	142.65	-17.96	0.1265	12.448
25.4	-11.81	0.2569	117.41	-41.51	0.0084	162.99	19.475	9.4138	135.76	-16.74	0.1456	11.766
25.6	-12.06	0.2495	114.9	-41.05	0.0089	157.69	19.17	9.0888	129.79	-17.66	0.1309	22.237
25.8	-12.55	0.2357	117.83	-41.34	0.0086	150.4	19.077	8.9921	124.04	-16.87	0.1433	0.7878
26	-12.48	0.2378	120.31	-41.95	0.008	145.28	18.968	8.8795	116.86	-17.58	0.1322	8.5083
26.2	-12.51	0.2367	121.69	-40.55	0.0094	143.86	18.767	8.6771	110.73	-17.75	0.1295	-6.375
26.4	-12.29	0.2429	123.23	-39.89	0.0101	139.48	18.629	8.5402	103.45	-16.9	0.1429	-7.881
26.6	-12.4	0.2398	123.93	-39.92	0.0101	132.24	18.45	8.3655	97.292	-17.16	0.1387	-20.1
26.8	-12.15	0.2468	125.41	-40.2	0.0098	126.75	18.298	8.2203	90.776	-16.55	0.1487	-31.85
27	-11.85	0.2556	125.81	-39.47	0.0106	126.31	18.124	8.0576	83.96	-17.36	0.1354	-34.26
27.2	-11.84	0.2558	124.87	-39.17	0.011	123.8	17.881	7.8349	78.019	-16.66	0.1468	-49.17
27.4	-11.86	0.2554	126.85	-39.01	0.0112	119.72	17.756	7.7234	71.862	-16.11	0.1564	-51.07
27.6	-11.53	0.2653	128.29	-38.6	0.0118	114.03	17.589	7.5765	65.475	-16.31	0.1529	-64.97
27.8	-11.31	0.2719	127.51	-38.23	0.0123	110.58	17.389	7.4038	59.28	-14.98	0.1782	-68.69
28	-11.04	0.2804	128.43	-38.11	0.0124	103.56	17.23	7.2697	53.236	-15.44	0.1691	-76.56

Note:

1. Data obtained from on-wafer measurements.

Biasing and Operation

The AMMC-5023 has four cascaded gain stages as shown in Figure 19. The first two gain stages at the input are biased with the V_{D1} drain supply. Similarly, the two output stages are biased with the V_{D2} supply. Standard LNA operation is with a single positive DC drain supply voltage ($V_{D1}=V_{D2}=5\text{ V}$) as shown in the assembly diagram, Figure 2(a).

If desired, the output stage DC supply voltage (V_{D2}) can be increased to improve output power capability while maintaining optimum low noise bias conditions for the input section. The output power may also be adjusted by applying a positive voltage at V_{G2} to alter the operating bias point for both the output FETs. Increasing the voltage applied to V_{G2} (more positively) results in a more negative gate-to-source voltage and, therefore, lower drain current. Figures 20(b) and 20(c) illustrate how the device can be assembled for independent drain supply operation and for output stage gate bias control.

Assembly Techniques

The backside of the MMIC chip is RF ground. For microstrip applications the chip should be attached directly to the ground plane (e.g. circuit carrier or heatsink) using electrically conductive epoxy^[1,2]. For conductive epoxy, the amount should be just enough to provide a thin fillet around the bottom perimeter of the die. The ground plane should be free of any residue that may jeopardize electrical or mechanical attachment. Caution should be taken to not exceed the Absolute Maximum Rating for assembly temperature and time.

Thermosonic wedge bonding is the preferred method for wire attachment to the bond pads. The RF connections should be kept as short as possible to minimize inductance. Gold mesh or double-bonding with 0.7 mil gold wire is recommended.

Mesh can be attached using a 2 mil round tracking tool and a tool force of approximately 22 grams with an ultrasonic power of roughly 55 dB for a duration of $76 \pm 8\text{ mS}$. A guided wedge at an ultrasonic power level of 64 dB can be used for the 0.7 mil wire. The recommended wire bond stage temperature is $150 \pm 2^\circ\text{C}$.

The chip is 100 mm thick and should be handled with care. This MMIC has exposed air bridges on the top surface. Handle at edges or with a custom collet (do not pick up die with vacuum on die center.)

This MMIC is also static sensitive and ESD handling precautions should be taken.

Notes:

1. Ablebond 84-1 LM1 silver epoxy is recommended.
2. Eutectic attach is not recommended and may jeopardize reliability of the device.

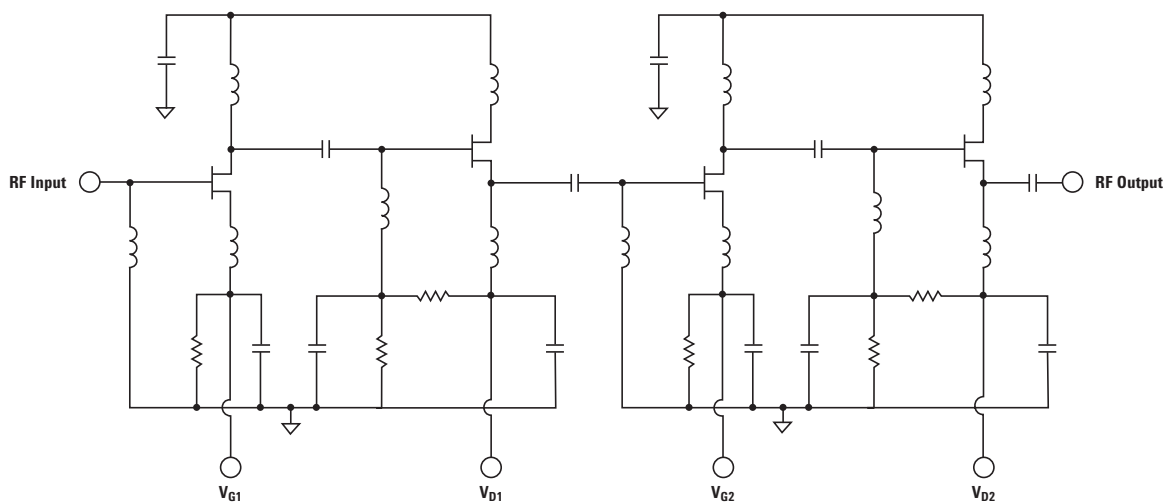
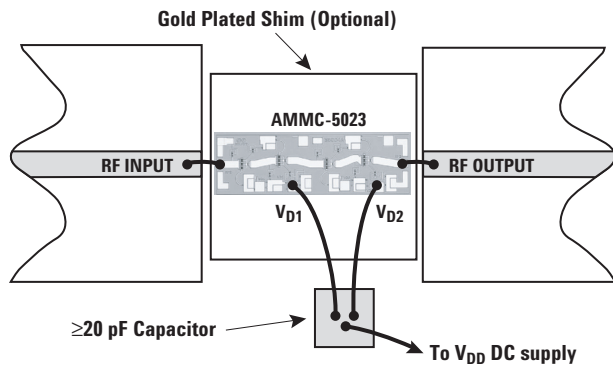
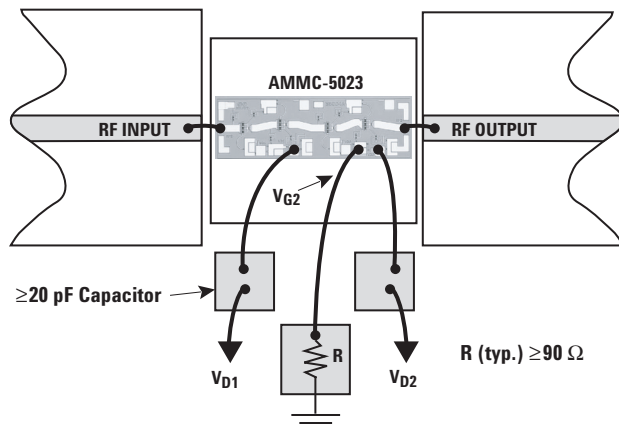

Figure 19. AMMC-5023 Schematic.



(a) Single DC Drain Supply Voltage.



(b) Assembly for custom biasing of output gain stages using an external chip-resistor.

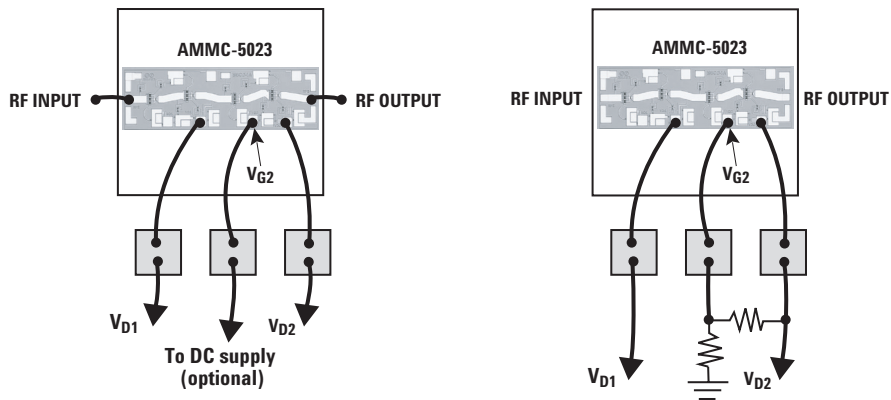

(c) A V_{G2} DC Supply or a resistive divider network can also be used to bias the output stages for custom application.

Figure 20. AMMC-5023 Assembly Diagrams.

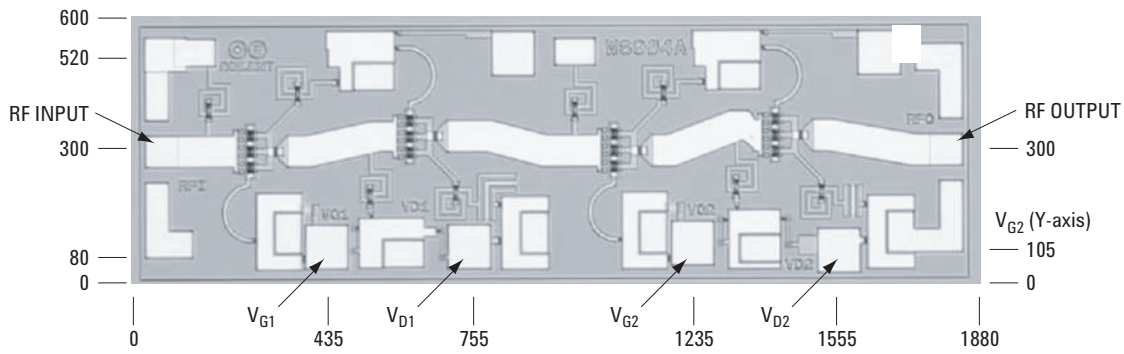

Figure 21. AMMC-5023 Bonding Pad Locations.
 (dimensions in micrometers)

Ordering Information

AMMC-5023-W10 = 10 devices per tray

AMMC-5023-W50 = 50 devices per tray

For product information and a complete list of distributors, please go to our web site: www.avagotech.com

Avago, Avago Technologies, and the A logo are trademarks of Avago Technologies Limited in the United States and other countries.
 Data subject to change. Copyright © 2005-2008 Avago Technologies Limited. All rights reserved. Obsoletes 5989-3930EN
 AV02-1313EN - May 29, 2008

