

Data Sheet

Description

Avago Technologies AMMC-6222 is an easy-to-use broadband, high gain, high linearity Low Noise Amplifier that operates from 7 GHz to 21GHz. The wide band and unconditionally stable performance makes this MMIC ideal as a primary or sub-sequential low noise block or a transmitter or LO driver. The MMIC has 3 gain stages and requires a 4V, 120mA power supply for optimal performance. It has a selectable pin to switch between low and high current, corresponding with low and high output power and linearity. DC-block capacitors are integrated at the input and output stages. Since this MMIC covers several bands, it can reduce part inventory and increase volume purchase options. The MMIC is fabricated using PHEMT technology to provide exceptional low noise, gain and power performance. The backside of the chip is both RF and DC ground which helps simplify the assembly process and reduce assembly related performance variations and cost.

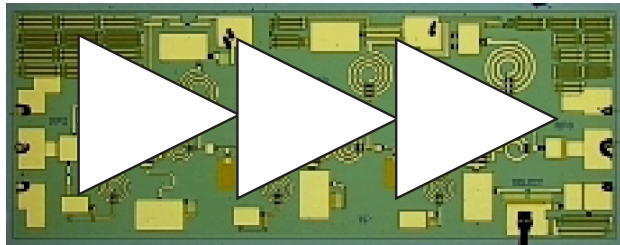

Chip Size: 800 μm x 2000 μm (31.5 x 78.74 mils)
Chip Size Tolerance: ± 10 μm (± 0.4 mils)
Chip Thickness: 100 \pm 10 μm (4 \pm 0.4 mils)
Pad Dimensions: 100 x 100 μm (4 x 4 mils)

Features

- 2000 μm x 800 μm Die Size
- Single Positive Bias Supply
- Selectable Output Power / Linearity
- No Negative Gate Bias

Specifications (V_{dd} = 4.0V, I_{dd} = 120mA)

- RF Frequencies: 7 - 21 GHz
- High Output IP₃: 29dBm
- High Small-Signal Gain: 25dB
- Typical Noise Figure: 2.4dB
- Input, Output Match: -10dB

Applications

- Microwave Radio systems
- Satellite VSAT, DBS Up/Down Link
- LMDS & Pt-Pt mmW Long Haul
- Broadband Wireless Access (including 802.16 and 802.20 WiMax)
- WLL and MMDS loops
- Commercial grade military

Note:

1. This MMIC uses depletion mode pHEMT devices.



Attention:
Observe precautions for handling electrostatic sensitive devices.

ESD Machine Model (60V)
ESD Human Body Model (150V)
Refer to Avago Application Note A004R:
Electrostatic Discharge Damage and Control

Absolute Maximum Ratings ⁽¹⁾

Parameters/Condition	Symbol	Unit	Max
Drain to Ground Voltage	Vdd	V	5.5
Gate-Drain Voltage	Vgd	V	-10
Drain Current	Idd	mA	170
RF CW Input Power Max	Pin	dBm	10
Max channel temperature	Tch	C	+150
Storage temperature	Tstg	C	-65 +150
Maximum Assembly Temp	Tmax	C	260 for 20s

(1) Operation in excess of any of these conditions may result in permanent damage to this device. The absolute maximum ratings for Vdd, Vgd, Idd and Pin were determined at an ambient temperature of 25°C unless noted otherwise.

DC Specifications/ Physical Properties ⁽²⁾

Parameter and Test Condition	Symbol	Unit	Min	Typ	Max
Drain Supply Current under any RF power drive and temp. (Vd=4.0 V)	Idd	mA	80	120	160
Drain Supply Voltage	Vd	V	3	4	5
Thermal Resistance ⁽³⁾	θjc	°C/W		31.4	

(2) Ambient operational temperature TA=25°C unless noted

(3) Channel-to-backside Thermal Resistance (Tchannel = 34°C) as measured using infrared microscopy. Thermal Resistance at backside temp. (Tb) = 25°C calculated from measured data.

AMMC-6222 RF Specifications

TA= 25°C, Vdd = 4.0 V, Idd=120mA, Zo=50 Ω

Parameters and Test Conditions	Symbol	Unit	Freq (GHz)	High Output Power Configuration			Low Output Power Configuration		
				Min	Typical	Max	Min	Typical	Max
Drain Current	Idd	mA			120			95	
Small-Signal Gain ^[4]	Gain	dB	9, 12, 17	20	26			24	
Noise Figure into 50Ω ^[4]	NF	dB	9		2.7	2.8		2.4	
			12		2.5	2.8		2.4	
			17		2.7	2.8		2.4	
Output Power at 1dB Gain Compression	P-1dB	dBm		13	15.5			15	
Output Third Order Intercept Point	OIP3	dBm	9, 12, 17	26	28			27	
Isolation	Iso	dB			-50			-50	
Input Return Loss	RLin	dB			-10			-10	
Output Return Loss	RLout	dB			-10			-10	

(4) All tested parameters guaranteed with measurement accuracy ± 2dB for gain and P1dB, ±0.8dB for NF and ±5dBm for OPI3 in the high output power configuration.

Typical distribution of Gain, Noise Figure and P1dB based on 1500 parts

AMMC-6222 Typical Performance for High Current, High Output Power Configuration [1]

($T_A = 25^\circ\text{C}$, $V_{dd}=4\text{V}$, $I_{dd}=120\text{mA}$, $Z_{in} = Z_{out} = 50 \Omega$, on-wafer unless noted)

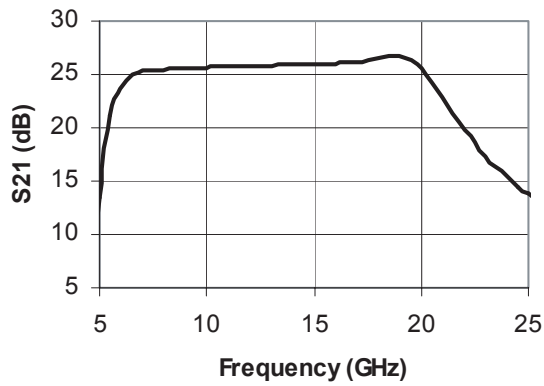

Figure 1a. Small-signal Gain

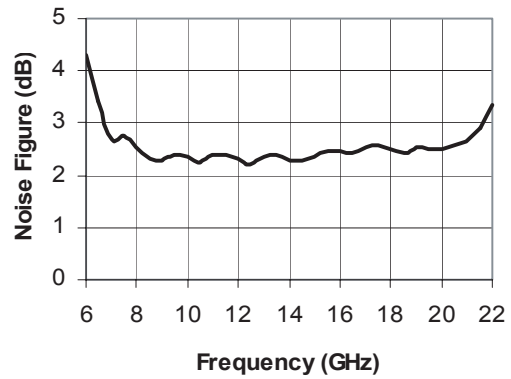

Figure 2a. Noise Figure

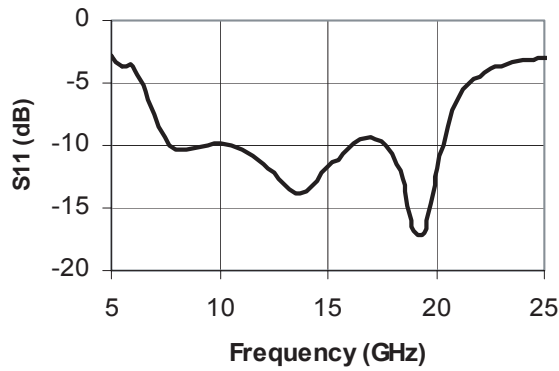

Figure 3a. Input Return Loss

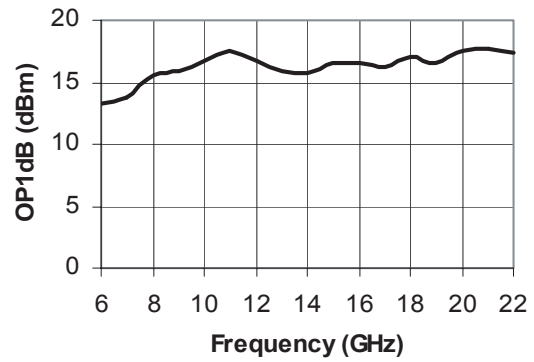

Figure 4a. Output P-1dB

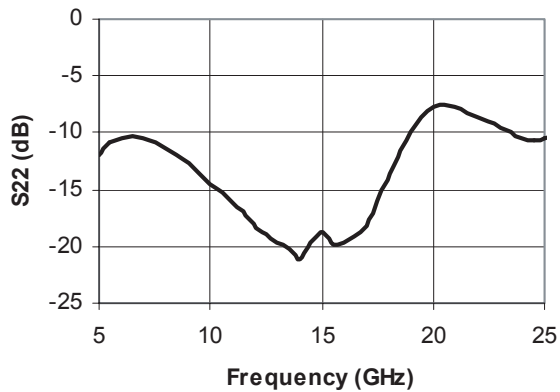

Figure 5a. Output Return Loss

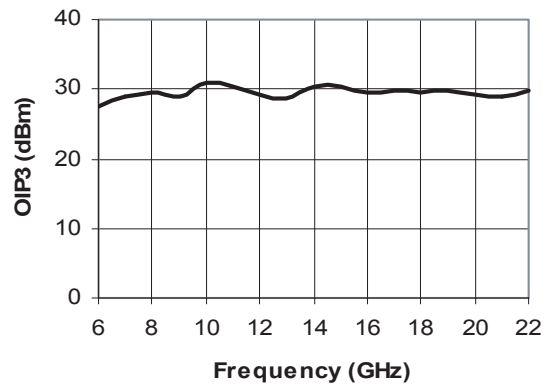

Figure 6a. Output IP3

Note:

[1] Noise Figure is measured with a 3-dB pad at input

AMMC-6222 Typical Performance for High Current, High Output Power Configuration (Cont)

($T_A = 25^\circ\text{C}$, $V_{dd}=4\text{V}$, $I_{dd}=120\text{mA}$, $Z_{in} = Z_{out} = 50 \Omega$, on-wafer unless noted)

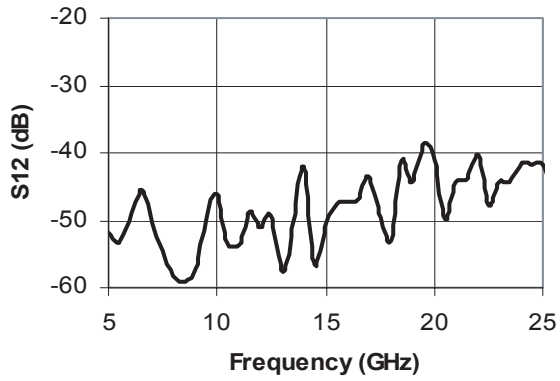

Figure 7a. Isolation

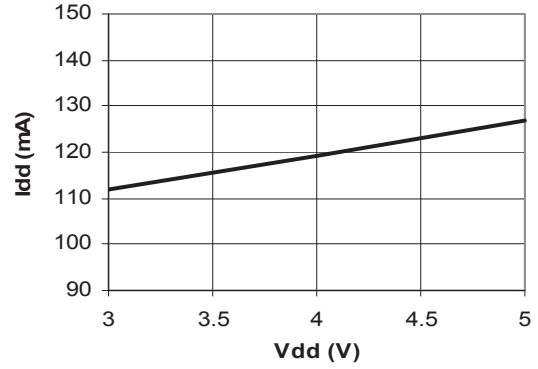

Figure 8a. I_{dd} over V_{dd}

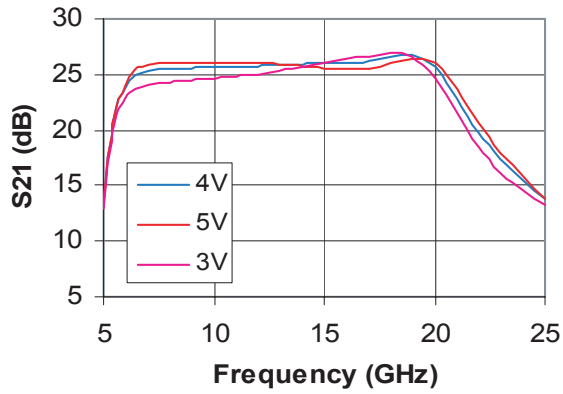

Figure 9a. Small-signal Gain Over V_{dd}

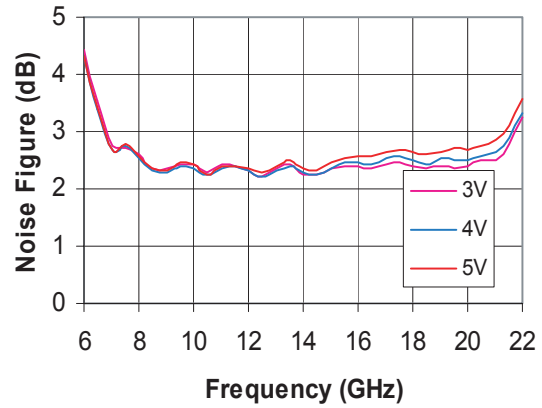

Figure 10a. Noise Figure Over V_{dd}

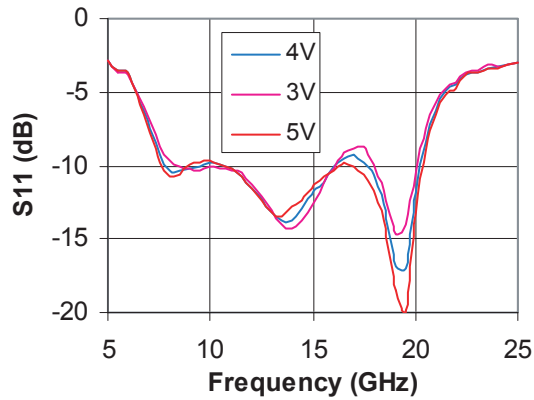

Figure 11a. Input Return Loss Over V_{dd}

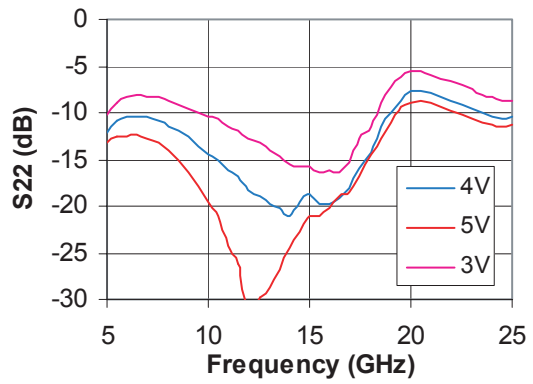

Figure 12a. Output Return Loss Over V_{dd}

AMMC-6222 Typical Performance for High Current, High Output Power Configuration (Cont)

($T_A = 25^\circ\text{C}$, $V_{dd}=4\text{V}$, $I_{dd}=120\text{mA}$, $Z_{in} = Z_{out} = 50 \Omega$, on-wafer unless noted)

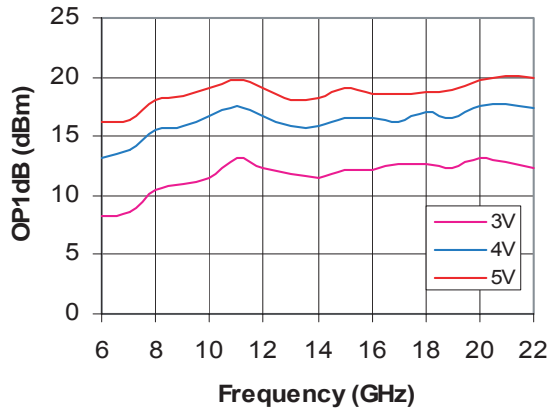

Figure 13a. Output P1dB over Vdd

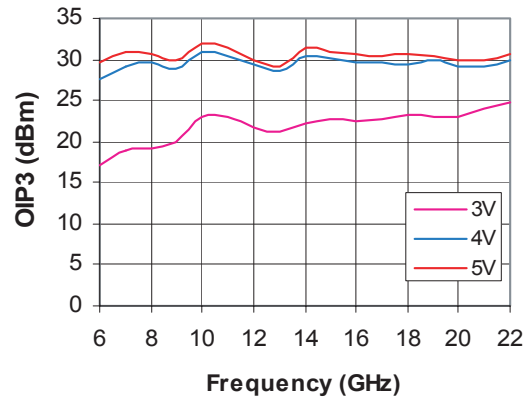

Figure 14a. Output IP3 over Vdd

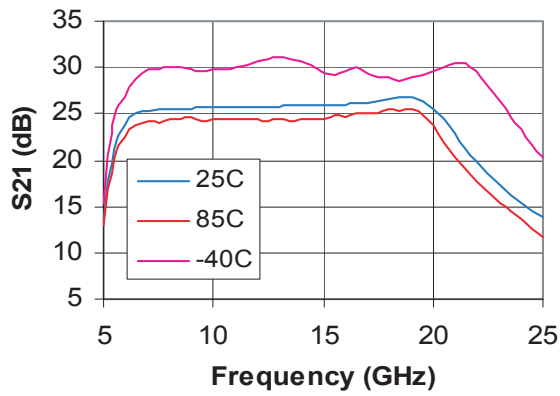

Figure 15a. Small-signal Gain Over Temp

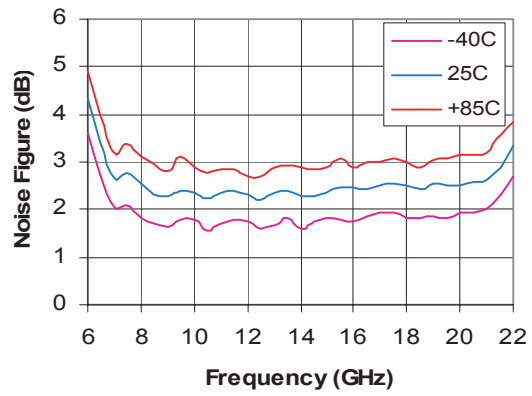

Figure 16a. Noise Figure Over Temp

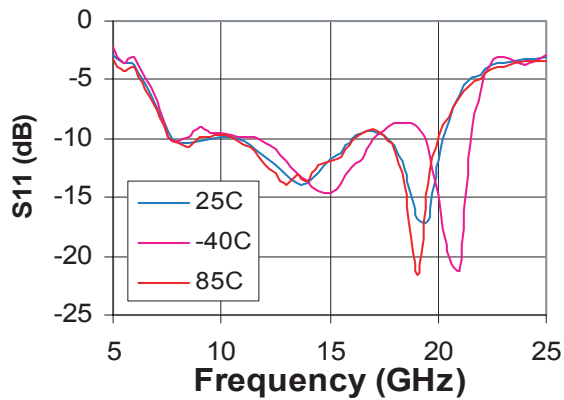

Figure 17a. Input Return Loss Over Temp

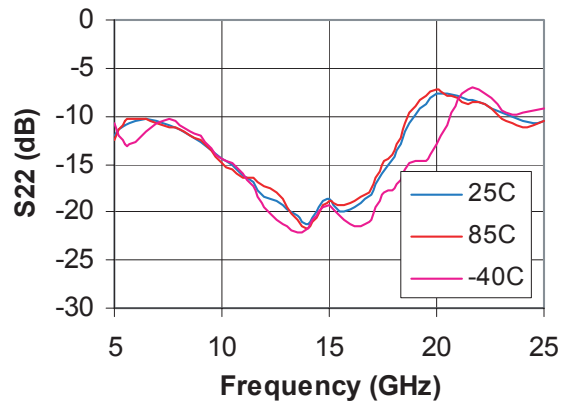

Figure 18a. Output Return Loss Over Temp

AMMC-6222 Typical Performance for Low Current, Low Output Power Configuration [1]

($T_A = 25^\circ\text{C}$, $V_{dd}=4\text{V}$, $I_{dd}=95\text{mA}$, $Z_{in} = Z_{out} = 50 \Omega$, on-wafer unless noted)

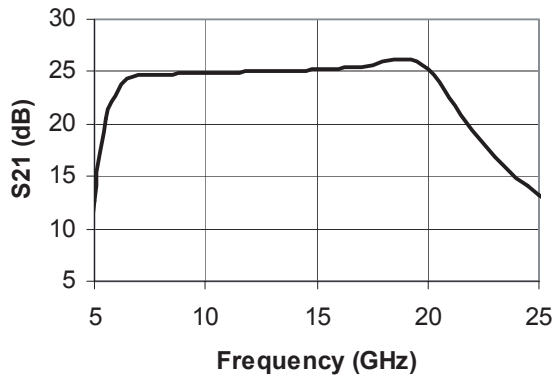

Figure 1b. Small-signal Gain

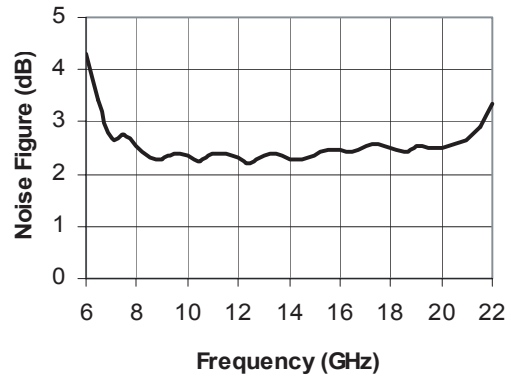

Figure 2b. Noise Figure

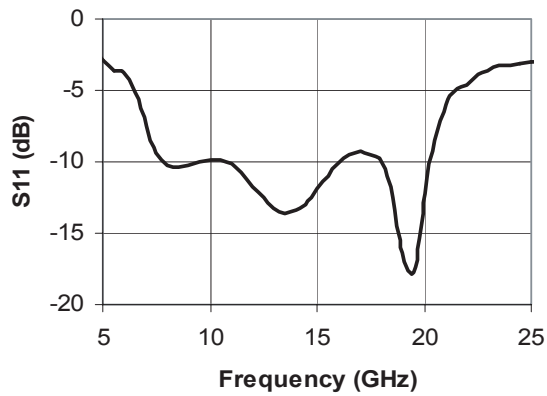

Figure 3b. Input Return Loss

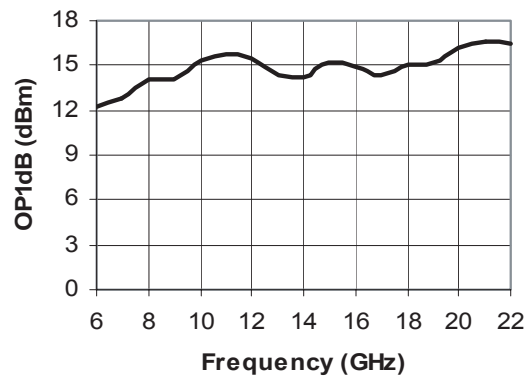

Figure 4b. Output P-1dB

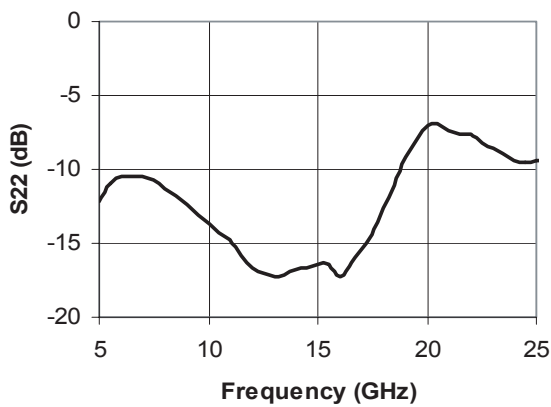

Figure 5b. Output Return Loss

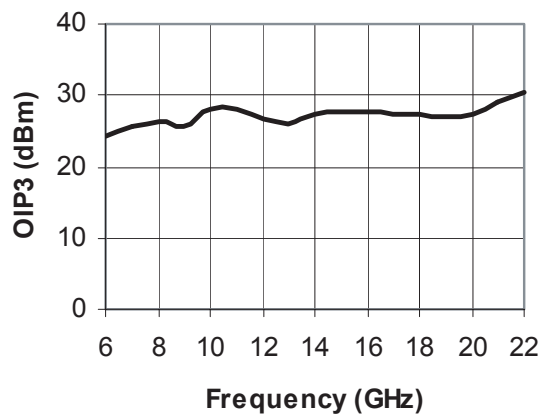

Figure 6b. Output IP3

Note:

[1] Noise Figure is measured with a 3-dB pad at input

AMMC-6222 Typical Performance for Low Current, Low Output Power Configuration (Cont)

($T_A = 25^\circ\text{C}$, $V_{dd}=4\text{V}$, $I_{dd}=95\text{mA}$, $Z_{in} = Z_{out} = 50 \Omega$, on-wafer unless noted)

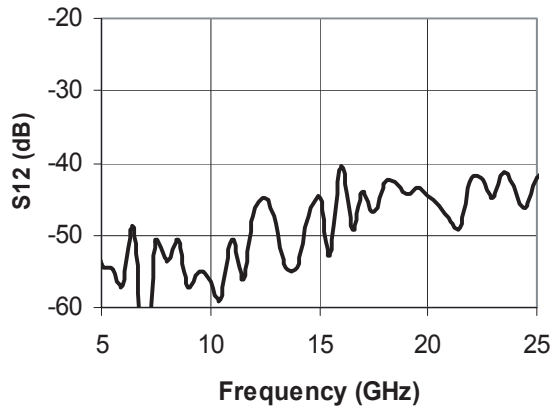

Figure 7b. Isolation

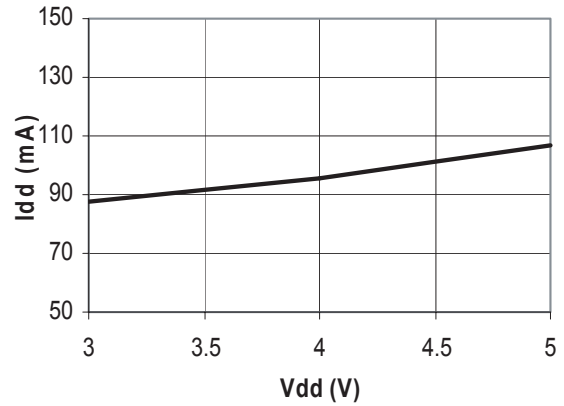

Figure 8b. Idd over Vdd

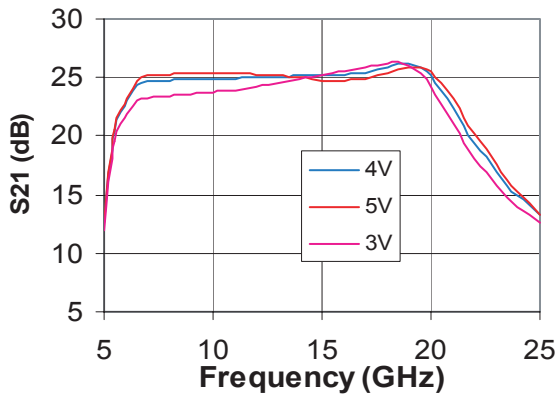

Figure 9b. Small-signal Gain Over Vdd

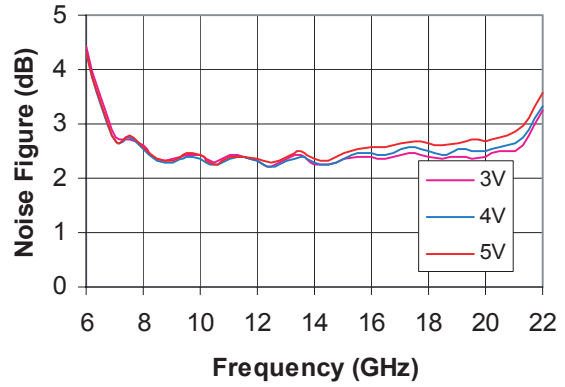

Figure 10b. Noise Figure Over Vdd

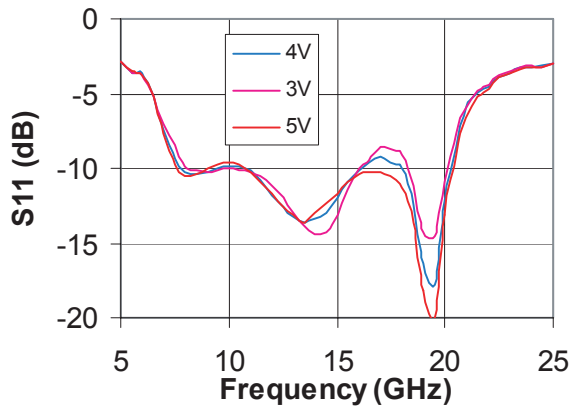

Figure 11b. Input Return Loss Over Vdd

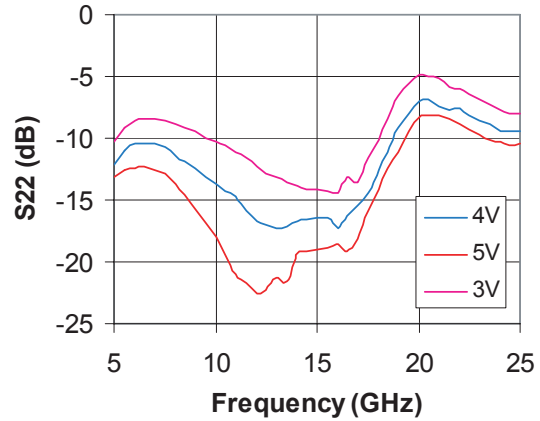

Figure 12b. Output Return Loss Over Vdd

AMMC-6222 Typical Performance for Low Current, Low Output Power Configuration (Cont)

($T_A = 25^\circ\text{C}$, $V_{dd}=4\text{V}$, $I_{dd}=95\text{mA}$, $Z_{in} = Z_{out} = 50 \Omega$, on-wafer unless noted)

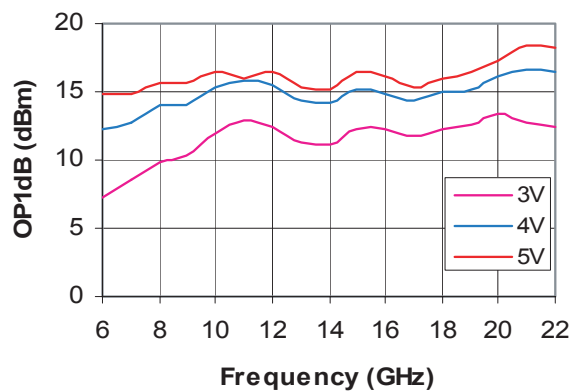

Figure 13b. Output P1dB over Vdd

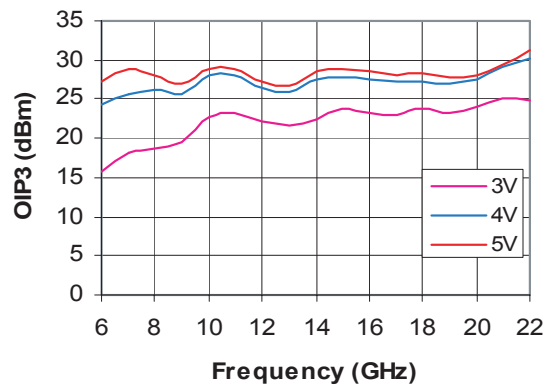

Figure 14b. Output IP3 over Vdd

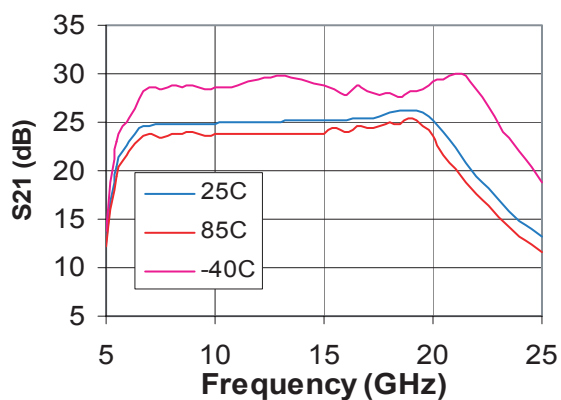

Figure 15b. Small-signal Gain Over Temp

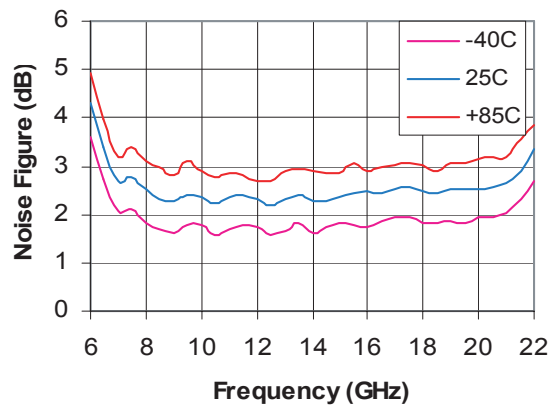

Figure 16b. Noise Figure Over Temp

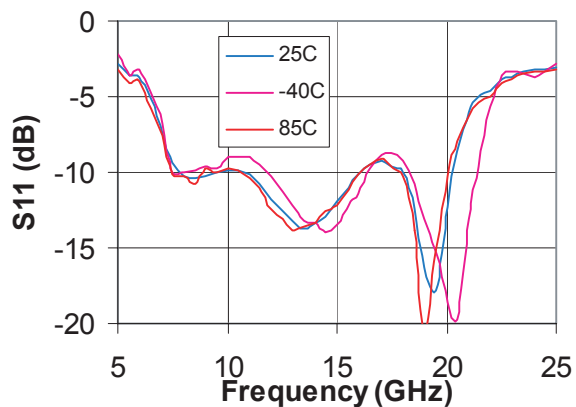

Figure 17b. Input Return Loss Over Temp

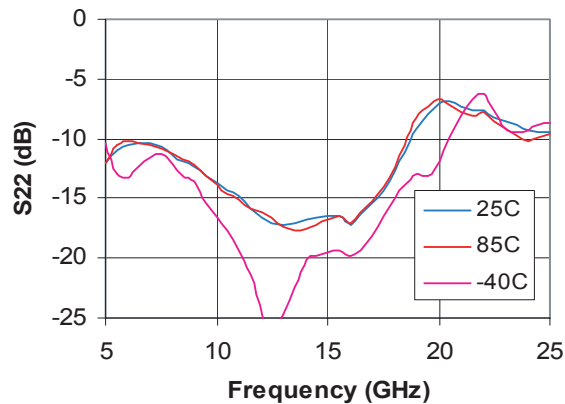

Figure 18b. Output Return Loss Over Temp

AMMC-6222 Typical S-parameters for High Current, High Output Power Configuration

($T_A = 25^\circ\text{C}$, $V_{dd}=4\text{V}$, $I_{dd}=120\text{mA}$, $Z_{in} = Z_{out} = 50 \Omega$, unless noted)

Freq	S11			S21			S12			S22		
	Mag	dB	Phase	Mag	dB	Phase	Mag	dB	Phase	Mag	dB	Phase
1.0	0.958	-0.369	-42.585	0.025	-32.145	15.098	0.002	-54.039	160.951	0.955	-0.396	-45.564
2.0	0.943	-0.511	-85.130	0.010	-40.003	-72.011	0.002	-54.714	-6.417	0.842	-1.493	-92.392
3.0	0.887	-1.043	-130.301	0.003	-50.353	74.224	0.003	-50.867	-171.915	0.567	-4.929	-136.051
4.0	0.826	-1.662	-179.572	0.053	-25.575	-79.948	0.003	-49.320	-68.291	0.309	-10.188	-150.923
5.0	0.719	-2.870	116.375	4.719	13.478	175.515	0.003	-51.960	50.230	0.250	-12.034	-143.827
6.0	0.656	-3.668	45.862	15.381	23.740	-1.209	0.003	-50.074	116.653	0.300	-10.464	-152.735
7.0	0.420	-7.537	-30.344	18.583	25.382	-109.904	0.003	-50.560	-175.569	0.300	-10.464	-170.564
7.5	0.343	-9.301	-51.489	18.736	25.453	-150.670	0.002	-54.592	-31.725	0.287	-10.842	-178.413
8.0	0.304	-10.335	-64.187	18.763	25.466	173.863	0.001	-58.379	161.675	0.269	-11.404	173.513
8.5	0.303	-10.381	-73.299	18.899	25.529	142.049	0.001	-59.185	-169.981	0.252	-11.984	167.378
9.0	0.308	-10.222	-84.517	19.030	25.589	112.342	0.001	-57.070	-142.568	0.233	-12.655	160.184
9.5	0.315	-10.039	-93.242	19.114	25.627	84.660	0.003	-49.818	-154.952	0.211	-13.517	155.593
10.0	0.324	-9.788	-103.763	19.083	25.613	58.470	0.005	-46.085	155.948	0.188	-14.529	151.330
10.5	0.319	-9.930	-113.583	19.224	25.677	33.313	0.002	-53.291	158.396	0.174	-15.170	147.947
11.0	0.307	-10.269	-122.903	19.221	25.676	9.250	0.002	-53.714	140.482	0.156	-16.115	148.189
11.5	0.288	-10.809	-133.557	19.292	25.708	-13.988	0.004	-48.760	78.912	0.143	-16.871	143.635
12.0	0.265	-11.537	-137.710	19.363	25.740	-36.291	0.003	-51.033	107.309	0.121	-18.374	145.331
12.5	0.245	-12.211	-141.574	19.463	25.784	-58.686	0.003	-49.131	152.693	0.114	-18.863	147.252
13.0	0.220	-13.136	-142.481	19.556	25.825	-80.428	0.001	-57.620	-54.808	0.103	-19.712	153.719
13.5	0.205	-13.764	-138.251	19.673	25.878	-101.794	0.003	-50.277	3.366	0.097	-20.294	164.351
14.0	0.206	-13.712	-132.747	19.794	25.931	-122.955	0.008	-42.043	99.356	0.088	-21.159	157.630
14.5	0.226	-12.908	-131.557	19.869	25.964	-143.907	0.002	-56.446	72.978	0.105	-19.595	169.074
15.0	0.261	-11.657	-132.953	19.871	25.965	-164.915	0.003	-50.181	-120.805	0.116	-18.680	171.150
15.5	0.276	-11.181	-135.309	19.851	25.956	174.722	0.004	-47.466	106.783	0.102	-19.837	172.930
16.0	0.313	-10.101	-142.068	19.991	26.017	153.950	0.004	-47.214	51.139	0.103	-19.759	174.219
16.5	0.336	-9.482	-148.918	20.247	26.127	133.650	0.004	-47.034	6.950	0.111	-19.108	-174.350
17.0	0.342	-9.317	-160.132	20.408	26.196	112.800	0.007	-43.391	23.918	0.124	-18.161	-167.129
17.5	0.326	-9.744	-177.532	20.916	26.410	91.502	0.003	-49.606	-16.727	0.160	-15.918	-166.639
18.0	0.296	-10.585	167.220	21.356	26.590	68.726	0.002	-52.996	-21.233	0.196	-14.164	-160.533
18.5	0.233	-12.639	140.958	21.803	26.770	45.177	0.009	-41.185	-37.409	0.264	-11.573	-169.415
19.0	0.143	-16.874	97.489	21.721	26.737	19.448	0.006	-44.362	-74.167	0.318	-9.952	-167.505
19.5	0.141	-17.030	21.792	20.980	26.436	-7.647	0.012	-38.649	-74.616	0.366	-8.728	169.416
20.0	0.254	-11.903	-34.484	19.075	25.609	-34.822	0.009	-41.290	-120.892	0.412	-7.692	154.876
20.5	0.379	-8.437	-63.459	16.444	24.320	-60.575	0.003	-49.931	-128.373	0.416	-7.619	141.729
21.0	0.488	-6.234	-85.656	13.851	22.829	-84.844	0.006	-44.264	-142.938	0.408	-7.782	131.465
21.5	0.566	-4.951	-101.220	11.582	21.276	-105.068	0.006	-44.104	179.334	0.383	-8.342	121.924
22.0	0.593	-4.540	-112.747	9.807	19.831	-123.629	0.010	-40.319	163.488	0.371	-8.623	113.370
22.5	0.645	-3.815	-122.787	8.561	18.650	-142.328	0.004	-47.699	90.728	0.351	-9.095	106.498
23.0	0.656	-3.656	-131.798	7.385	17.367	-160.169	0.006	-44.248	-147.408	0.330	-9.637	102.785
23.5	0.681	-3.339	-138.376	6.505	16.265	-177.420	0.006	-44.247	134.235	0.317	-9.987	97.717
24.0	0.691	-3.216	-144.409	5.863	15.362	165.418	0.008	-41.531	127.333	0.301	-10.422	93.152
24.5	0.695	-3.158	-149.584	5.317	14.514	147.899	0.008	-41.678	92.935	0.293	-10.661	90.399
25.0	0.704	-3.049	-154.135	4.876	13.762	128.607	0.008	-41.650	105.561	0.298	-10.503	87.296
26.0	0.722	-2.825	-160.157	4.092	12.239	87.007	0.008	-41.764	89.928	0.313	-10.096	81.462
27.0	0.795	-1.996	-166.749	3.116	9.872	40.634	0.006	-43.810	36.999	0.315	-10.031	65.876
28.0	0.857	-1.337	-174.436	2.113	6.497	-5.679	0.003	-49.131	7.556	0.265	-11.549	52.731
29.0	0.885	-1.059	176.306	1.300	2.276	-50.078	0.005	-45.751	-10.362	0.187	-14.567	58.879
30.0	0.905	-0.869	168.094	0.738	-2.633	-93.382	0.005	-46.303	12.057	0.247	-12.142	80.544
31.0	0.909	-0.833	160.078	0.364	-8.780	-136.356	0.005	-45.860	-50.824	0.406	-7.822	70.378
32.0	0.918	-0.747	153.846	0.158	-16.027	-169.736	0.004	-48.671	-2.151	0.494	-6.122	49.792
33.0	0.910	-0.821	148.083	0.059	-24.624	161.165	0.004	-48.546	-63.827	0.555	-5.118	29.589
34.0	0.910	-0.818	142.295	0.023	-32.903	155.942	0.003	-49.944	-48.678	0.557	-5.078	14.551
35.0	0.909	-0.828	137.375	0.001	-58.256	-4.538	0.006	-43.933	116.000	0.560	-5.033	0.044
36.0	0.921	-0.711	131.566	0.001	-57.084	40.788	0.007	-43.392	-67.365	0.563	-4.984	-13.521
37.0	0.922	-0.704	126.811	0.001	-57.443	-159.263	0.005	-45.491	66.314	0.550	-5.196	-24.690
38.0	0.937	-0.566	122.092	0.011	-39.503	-162.868	0.005	-46.741	-87.366	0.555	-5.114	-36.643
39.0	0.924	-0.690	118.056	0.005	-45.942	-142.066	0.010	-39.684	-27.659	0.557	-5.091	-48.171
40.0	0.942	-0.518	111.931	0.001	-56.827	178.467	0.004	-47.008	112.278	0.555	-5.113	-57.836

Note: S-parameters are measured on wafer.

AMMC-6222 Typical S-parameters for Low Current, Low Output Power Configuration

($T_A = 25^\circ\text{C}$, $V_{dd}=4\text{V}$, $I_{dd}=95\text{mA}$, $Z_{in} = Z_{out} = 50 \Omega$, unless noted)

Freq	S11			S21			S12			S22		
	Mag	dB	Phase	Mag	dB	Phase	Mag	dB	Phase	Mag	dB	Phase
1.0	0.962	-0.335	-42.538	0.025	-32.087	13.169	0.003	-50.752	-174.263	0.951	-0.436	-45.616
2.0	0.941	-0.527	-85.137	0.012	-38.676	-75.007	0.001	-57.595	157.515	0.840	-1.513	-91.967
3.0	0.891	-1.003	-130.190	0.002	-55.364	105.291	0.004	-48.792	31.277	0.564	-4.967	-135.409
4.0	0.831	-1.608	-179.625	0.052	-25.681	-85.000	0.003	-50.122	-173.499	0.307	-10.255	-149.880
5.0	0.721	-2.836	116.552	4.287	12.642	175.992	0.002	-53.846	105.846	0.249	-12.087	-141.969
6.0	0.654	-3.690	46.101	14.129	23.002	-0.999	0.001	-56.923	-101.206	0.299	-10.484	-149.268
7.0	0.424	-7.461	-29.583	17.103	24.661	-109.868	0.000	-73.579	-19.666	0.301	-10.437	-165.184
7.5	0.338	-9.414	-50.638	17.206	24.714	-150.741	0.003	-51.024	-91.770	0.292	-10.680	-173.367
8.0	0.307	-10.270	-63.069	17.251	24.736	173.812	0.002	-53.734	141.876	0.270	-11.360	179.478
8.5	0.303	-10.380	-72.706	17.351	24.787	141.969	0.003	-50.710	-160.705	0.256	-11.821	174.288
9.0	0.308	-10.225	-83.172	17.456	24.839	112.316	0.001	-57.257	-102.126	0.240	-12.390	168.073
9.5	0.316	-10.014	-93.100	17.542	24.882	84.762	0.002	-55.035	-146.430	0.220	-13.145	164.231
10.0	0.321	-9.859	-103.836	17.551	24.886	58.569	0.002	-56.389	92.603	0.207	-13.663	162.236
10.5	0.320	-9.904	-113.899	17.670	24.945	33.331	0.001	-58.861	123.654	0.193	-14.288	158.893
11.0	0.312	-10.127	-123.713	17.640	24.930	9.278	0.003	-50.616	99.152	0.183	-14.751	157.301
11.5	0.289	-10.771	-131.699	17.744	24.981	-13.825	0.002	-56.138	96.394	0.162	-15.819	157.504
12.0	0.257	-11.785	-137.219	17.779	24.998	-36.099	0.004	-47.331	46.111	0.147	-16.653	156.676
12.5	0.236	-12.541	-142.226	17.849	25.032	-58.439	0.006	-44.798	84.320	0.140	-17.057	157.174
13.0	0.219	-13.202	-142.287	17.945	25.079	-80.117	0.004	-48.317	49.303	0.138	-17.232	161.962
13.5	0.207	-13.667	-139.180	18.006	25.109	-101.409	0.002	-54.607	8.850	0.139	-17.119	166.776
14.0	0.215	-13.352	-133.145	18.094	25.150	-122.564	0.002	-54.422	-32.746	0.146	-16.728	168.536
14.5	0.224	-12.985	-130.910	18.118	25.162	-143.379	0.004	-47.218	104.834	0.147	-16.625	167.871
15.0	0.254	-11.911	-128.739	18.139	25.172	-164.060	0.006	-44.923	3.838	0.151	-16.419	171.426
15.5	0.283	-10.967	-134.375	18.169	25.186	175.628	0.002	-52.813	49.948	0.150	-16.470	169.847
16.0	0.311	-10.146	-140.893	18.317	25.257	155.106	0.009	-40.453	42.270	0.137	-17.279	165.829
16.5	0.333	-9.548	-149.070	18.592	25.387	134.914	0.003	-49.122	30.790	0.153	-16.332	173.852
17.0	0.345	-9.247	-161.595	18.720	25.446	114.240	0.006	-44.063	-32.075	0.169	-15.436	176.457
17.5	0.333	-9.553	-175.383	19.262	25.694	93.283	0.005	-46.681	-6.002	0.191	-14.363	-178.727
18.0	0.315	-10.035	169.381	19.750	25.911	70.555	0.007	-42.547	15.335	0.234	-12.631	-174.029
18.5	0.237	-12.499	144.360	20.221	26.116	47.222	0.007	-42.627	-43.074	0.279	-11.089	-179.874
19.0	0.152	-16.345	107.475	20.264	26.135	21.779	0.006	-44.194	-44.587	0.346	-9.207	174.465
19.5	0.129	-17.787	25.651	19.801	25.934	-5.343	0.007	-43.522	-73.089	0.400	-7.958	162.697
20.0	0.244	-12.246	-34.057	18.151	25.178	-32.721	0.006	-44.462	-137.245	0.446	-7.015	148.464
20.5	0.375	-8.528	-61.914	15.744	23.943	-59.023	0.005	-45.997	-120.749	0.453	-6.882	137.895
21.0	0.499	-6.029	-86.201	13.273	22.459	-83.955	0.004	-48.131	65.659	0.429	-7.357	125.124
21.5	0.564	-4.967	-101.033	11.064	20.878	-104.192	0.004	-49.093	140.120	0.414	-7.660	117.781
22.0	0.589	-4.604	-112.661	9.349	19.415	-122.851	0.008	-42.056	-162.159	0.417	-7.596	108.351
22.5	0.642	-3.843	-122.733	8.149	18.222	-141.499	0.008	-42.454	-147.348	0.390	-8.180	102.329
23.0	0.656	-3.656	-131.817	7.033	16.942	-159.419	0.006	-44.841	155.781	0.374	-8.535	97.683
23.5	0.685	-3.285	-138.570	6.187	15.829	-176.904	0.009	-41.119	124.778	0.359	-8.894	92.576
24.0	0.691	-3.216	-144.450	5.556	14.895	165.978	0.006	-44.031	128.276	0.340	-9.361	89.423
24.5	0.695	-3.165	-149.994	5.041	14.050	148.467	0.005	-46.248	112.911	0.336	-9.486	86.583
25.0	0.707	-3.014	-154.592	4.618	13.290	129.048	0.008	-41.965	118.649	0.337	-9.442	82.386
26.0	0.721	-2.838	-160.577	3.856	11.724	87.691	0.008	-41.539	53.291	0.349	-9.138	75.159
27.0	0.790	-2.048	-166.566	2.943	9.376	41.838	0.006	-44.504	40.248	0.346	-9.216	60.597
28.0	0.844	-1.475	-175.401	1.995	5.999	-4.502	0.006	-44.247	-18.090	0.307	-10.245	47.676
29.0	0.882	-1.090	175.982	1.236	1.839	-48.826	0.004	-47.299	-17.422	0.228	-12.833	49.752
30.0	0.900	-0.914	167.809	0.709	-2.988	-92.320	0.004	-47.858	16.674	0.265	-11.542	66.161
31.0	0.908	-0.837	159.901	0.352	-9.068	-134.770	0.005	-46.229	-4.192	0.407	-7.798	60.434
32.0	0.917	-0.757	154.299	0.151	-16.400	-170.422	0.005	-46.661	87.363	0.499	-6.032	42.716
33.0	0.911	-0.813	147.702	0.061	-24.234	162.859	0.006	-44.888	4.876	0.558	-5.068	24.243
34.0	0.912	-0.803	142.026	0.021	-33.727	148.879	0.007	-42.683	-36.025	0.568	-4.921	10.668
35.0	0.913	-0.795	136.930	0.001	-57.168	147.445	0.004	-47.125	8.635	0.559	-5.052	-3.636
36.0	0.918	-0.746	131.653	0.010	-40.306	160.921	0.002	-52.995	156.837	0.573	-4.829	-16.469
37.0	0.915	-0.769	126.060	0.006	-44.992	-53.650	0.006	-44.896	-80.908	0.568	-4.920	-27.330
38.0	0.934	-0.595	122.598	0.008	-41.821	-59.627	0.002	-53.072	-63.060	0.568	-4.906	-38.013
39.0	0.926	-0.666	117.822	0.008	-41.834	-173.776	0.003	-49.402	-109.021	0.566	-4.945	-48.328
40.0	0.942	-0.516	111.706	0.004	-46.946	-142.305	0.004	-48.157	-95.137	0.574	-4.823	-58.602

Note: S-parameters are measured on wafer.

AMMC-6222 Application and Usage

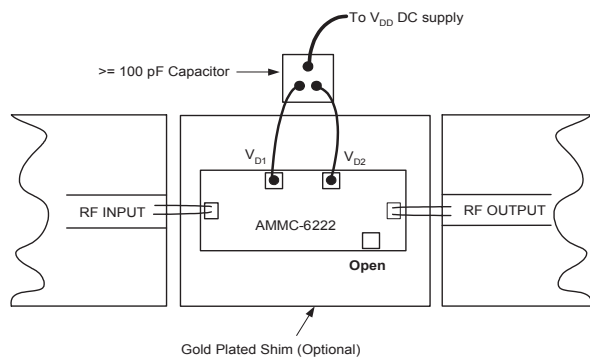

Figure 19. Low Current, Low Output Power State

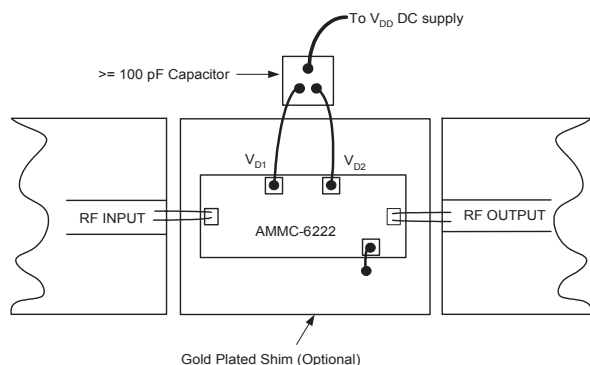

Figure 20. High Current, High Output Power State

Biasing and Operation

The AMMC-6222 is normally biased with a positive drain supply connected to the VD1 and VD2 pads through bypass capacitor as shown in Figures 19 and 20. The recommended drain supply voltage for general usage is 4V and the corresponding drain current is approximately 120mA. It is important to have at least 100pF bypass capacitor and the capacitor should be placed as close to the component as possible. Aspects of the amplifier performance may be improved over a narrower bandwidth by application of additional conjugate, linearity, or low noise (Topt) matching.

For receiver front end low noise applications where high power and linearity are not often required, the AMMC-6222 can be set in low current state when SELECT pad is open as shown in Figure 19. In this configuration, the bias current is approximately 85mA, 95mA and 105mA for 3V, 4V and 5V respectively.

In applications where high output power and linearity are often required such as LO or transmitter drivers, the AMMC-6222 can be selected to operate at its highest output power by grounding SELECT pad as shown in Figure 20. At 5V, the amplifier can provide Psat of about 20dBm. The bias current in this configuration is 115mA, 120mA and 125mA for 3V, 4V and 5V respectively.

In both cases, bonding wires at the input and output in the range of 0.15nH would likely improve the overall Noise Figure and input, output match at most frequencies.

No ground wires are needed because all ground connections are made with plated through-holes to the backside of the substrate.

Refer the Absolute Maximum Ratings table for allowed DC and thermal condition.

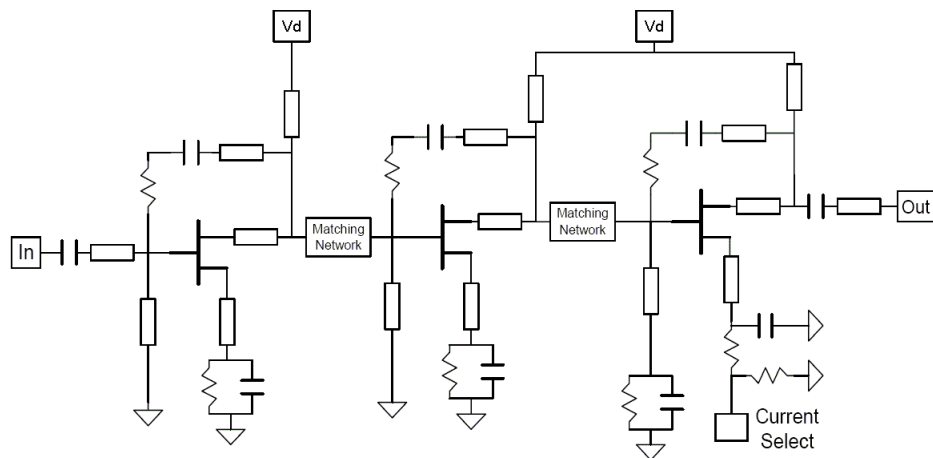

Figure 21. Simplified High Linearity LNA Schematic

Assembly Techniques

The backside of the MMIC chip is RF ground. For microstrip applications the chip should be attached directly to the ground plane (e.g. circuit carrier or heatsink) using electrically conductive epoxy [1]

For best performance, the topside of the MMIC should be brought up to the same height as the circuit surrounding it. This can be accomplished by mounting a gold plated metal shim (same length as the MMIC) under the chip which is of correct thickness to make the chip and adjacent circuit the same height. The amount of epoxy used for the chip or shim attachment should be just enough to provide a thin fillet around the bottom perimeter of the chip. The ground plane should be free of any residue that may jeopardize electrical or mechanical attachment.

RF connections should be kept as short as reasonable to minimize performance degradation due to undesirable series inductance. A single bond wire is normally sufficient for signal connections, however double bonding with 0.7mil gold wire will reduce series inductance. Gold thermo-sonic wedge bonding is the preferred method for wire attachment to the bond pads. The recommended wire bond stage temperature is $150^{\circ}\text{C} \pm 2^{\circ}\text{C}$.

Caution should be taken to not exceed the Absolute Maximum Rating for assembly temperature and time.

The chip is 100um thick and should be handled with care. This MMIC has exposed air bridges on the top surface and should be handled by the edges or with a custom collet (do not pick up the die with a vacuum on die center). Bonding pads and chip backside metallization are gold.

This MMIC is also static sensitive and ESD precautions should be taken

For more detailed information see Avago Technologies' application note #54 "GaAs MMIC assembly and handling guidelines"

Notes:

[1] Ablebond 84-1 LMI silver epoxy is recommended

Ordering Information:

AMMC-6222-W10 = 10 devices per tray

AMMC-6222-W50 = 50 devices per tray

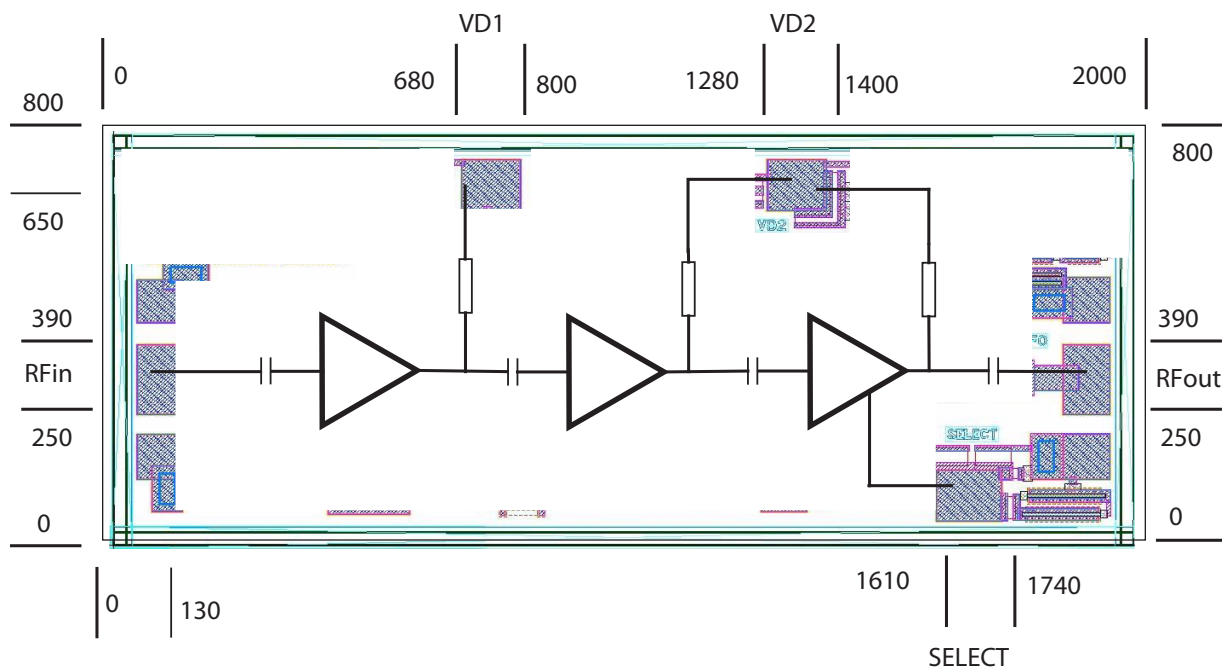

Figure 22. Bond Pad Locations

For product information and a complete list of distributors, please go to our web site: www.avagotech.com

Avago, Avago Technologies, and the A logo are trademarks of Avago Technologies, Limited in the United States and other countries. Data subject to change. Copyright © 2006 Avago Technologies Limited. All rights reserved. AV01-0439EN - November 24, 2006

AVAGO
TECHNOLOGIES