

FEATURES

- Trimmed 0.25% Reference
- Wide Operating Current Range 250 μ A to 150mA
- Low Dynamic Output Impedance
- Low Output Noise
- Nominal Temperature Range to 85°C
- Temperature-Compensated: 60ppm/°C
- Internal Amplifier with 150mA Capability

APPLICATIONS

- Battery Powered Systems
- Switching Power Supplies
- Adjustable Power Supplies
- Linear Regulators
- Error Amplifiers
- Notebook/Personal Computer
- Monitors/ VCR/ TV
- Pagers

GENERAL DESCRIPTION

The AMS431 is a three-terminal adjustable shunt regulator with guaranteed temperature stability over the entire range of operation. The output voltage can be set to any value between 2.5V (VREF) and 36V by adding two external resistors. Due to the sharp turn-on characteristics this device is an excellent replacement for zener diodes in many applications.

AMS431 is available in TO-92, SO-8, SOT-89 and SOT-23 packages.

ORDERING INFORMATION:

TOL.	PACKAGE TYPE				OPERATING TEMP. RANGE
	TO-92	8 LEAD SOIC	SOT-89	3 LEAD SOT-23	
±0.25%	AMS431AN	AMS431AS	AMS431AL	AMS431AM	-40 to +85° C
±0.5%	AMS431BN	AMS431BS	AMS431BL	AMS431BM	-40 to +85° C
±1.0%	AMS431CN	AMS431CS	AMS431CL	AMS431CM	-40 to +85° C

PIN CONNECTIONS

TO-92
Plastic Package (N)

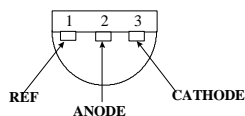

Bottom View

8L SOIC
SO Package (S)

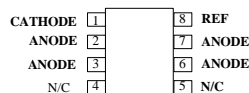

Top View

SOT-89
(L)

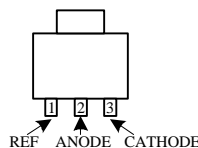

Top View

3L SOT-23
(M)

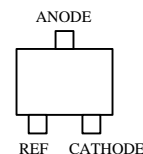

Top View

ABSOLUTE MAXIMUM RATINGS (Note 1)

Cathode Voltage (V_Z)	37V	Internal Power Dissipation (P_D)	
Continuous Cathode Current (I_Z)	-10mA to +150mA	TO-92 Package	0.78W
Reference Input Current (I_{REF})	10mA	SO-8 Package	0.71W
Junction Temperature (T_J)	-40°C to +125°C	SOT-89 Package	0.91W
		SOT-23 Package	0.28W
Storage temperature	-65°C to +150°C	Thermal Resistance (ϕ_{JA})	
Lead Temperature (Soldering, 10sec.)	265°C	TO-92 Package	160°C/W
		SO-8 Package	175°C/W
		SOT-89 Package	110°C/W
		SOT-23 Package	410°C/W

Note 1 : Absolute Maximum Ratings indicate limits beyond which damage to the device may occur. Operating Ratings indicate conditions for which the device is intended to be functional, but do not guarantee specific performance limits. For guaranteed specifications and test conditions, see the Electrical Characteristics. The guaranteed specifications apply only for the test conditions listed.

ELECTRICAL CHARACTERISTICS

Electrical Characteristics at $I_Z=10$ mA and $T_A = +25^\circ\text{C}$ unless otherwise specified.

Parameter	Conditions	AMS431A			AMS431B			AMS431C			Units
		Min	Typ	Max	Min	Typ	Max	Min	Typ	Max	
Reference Voltage		2.489	2.495	2.501	2.483	2.495	2.507	2.470	2.495	2.520	V
Deviation of Reference Input Voltage over Temperature	$V_Z = V_{REF}$ (circuit 1) $T_A = +25^\circ\text{C}$ to $+85^\circ\text{C}$ $T_A = -40^\circ\text{C}$ to $+25^\circ\text{C}$		8.0	15		8.0	15		8.0	15	mV
			8.0	15		8.0	15		8.0	15	mV
Ratio of Change in Reference Voltage to Cathode Voltage	V_Z from V_{REF} to 10V		-0.5	-2.7		-0.5	-2.7		-0.5	-2.7	mV/V
	V_Z from V_{REF} to 36V		-1.0	-2.0		-1.0	-2.0		-1.0	-2.0	mV/V
Reference Input Current	$R1 = 10\text{k}\Omega$, $R2 = \infty\Omega$ (test circuit 2)		0.5	4.0		0.5	4.0		0.5	4.0	μA
Reference Input Current Deviation over Temperature	$R1 = 10\text{k}\Omega$, $R2 = \infty\Omega$ $T_A = \text{Full Range}$ (test circuit 2)		0.4	1.2		0.4	1.2		0.4	1.2	μA
Off State Cathode Current	$V_Z = 36\text{V}$, $V_{REF} = 0\text{V}$ (test circuit 3)		0.04	0.5		0.04	0.5		0.04	0.5	μA
Dynamic Output Impedance	$f < 1\text{KHz}$, $V_Z = V_{REF}$ $I_Z = 100\mu\text{A}$ to 100mA (test circuit 1)		0.25	0.5		0.25	0.5		0.25	0.5	Ω
Minimum Operating Current	$V_Z = V_{REF}$ (test circuit 1)		100	250		100	250		100	250	μA

RECOMMENDED OPERATING CONDITIONS:

	Min	Max
Cathode Voltage, (V_Z)	V_{REF}	36 V
Cathode Current, (I_Z)	0.25mA	120mA

TYPICAL APPLICATIONS (Continued)

Over Voltage/Under Voltage Protection Circuit

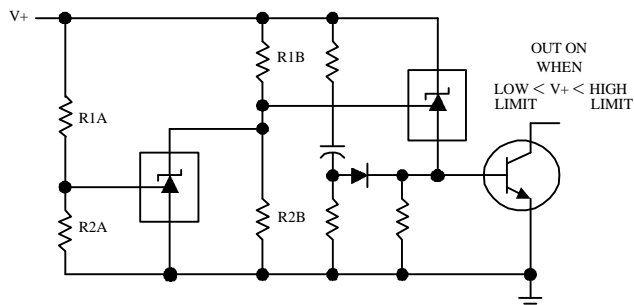

$$\text{LOW LIMIT} \approx V_{\text{REF}}(1 + R1B/R2B) + V_{\text{BE}}$$

$$\text{LOW LIMIT} \approx V_{\text{REF}}(1 + R1A/R2A)$$

Voltage Monitor

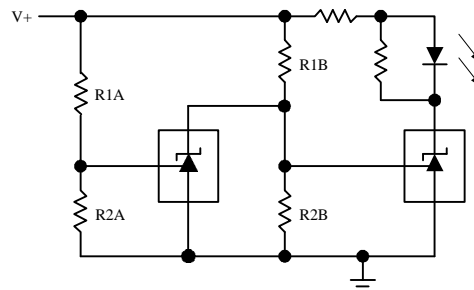

$$\text{LOW LIMIT} \approx V_{\text{REF}}(1 + R1B/R2B) + V_{\text{BE}}$$

$$\text{LOW LIMIT} \approx V_{\text{REF}}(1 + R1A/R2A)$$

LED ON WHEN LOW LIMIT < V+ < HIGH LIMIT

Delay Timer

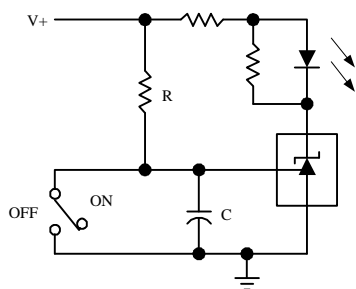

$$\text{DELAY} = R * C * \ln * V+ / (V+ - V_{\text{REF}})$$

Current Limiter or Current Source

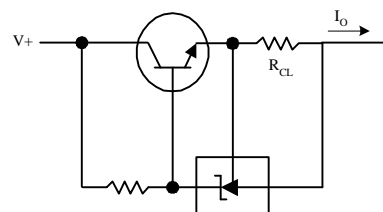

$$I_O = V_{\text{REF}} / R_{\text{CL}}$$

Constant Current Sink

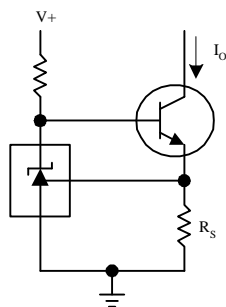

$$I_O = V_{\text{REF}} / R_S$$

TYPICAL PERFORMANCE CHARACTERISTICS

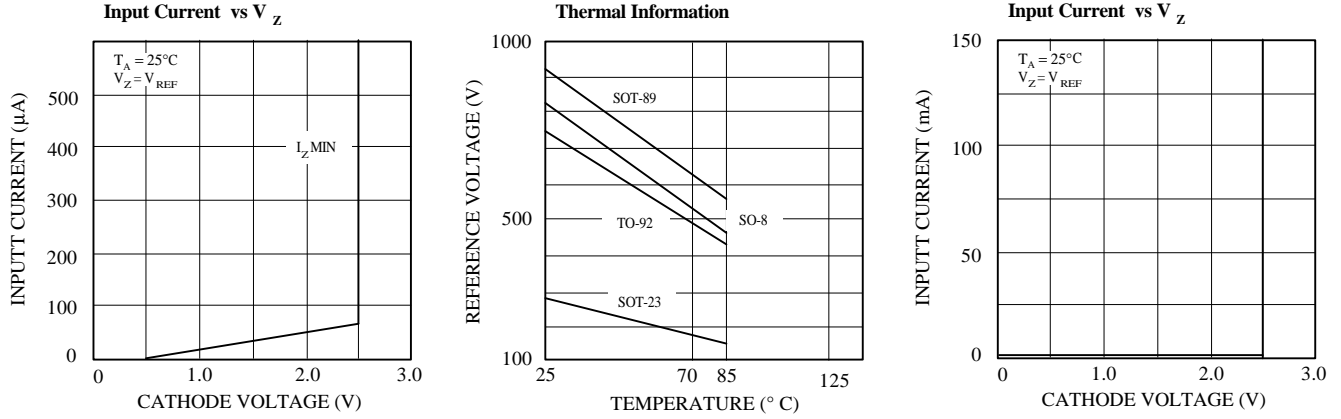

PACKAGE DIMENSIONS inches (millimeters) unless otherwise noted.

3L TO-92 PLASTIC PACKAGE (N)

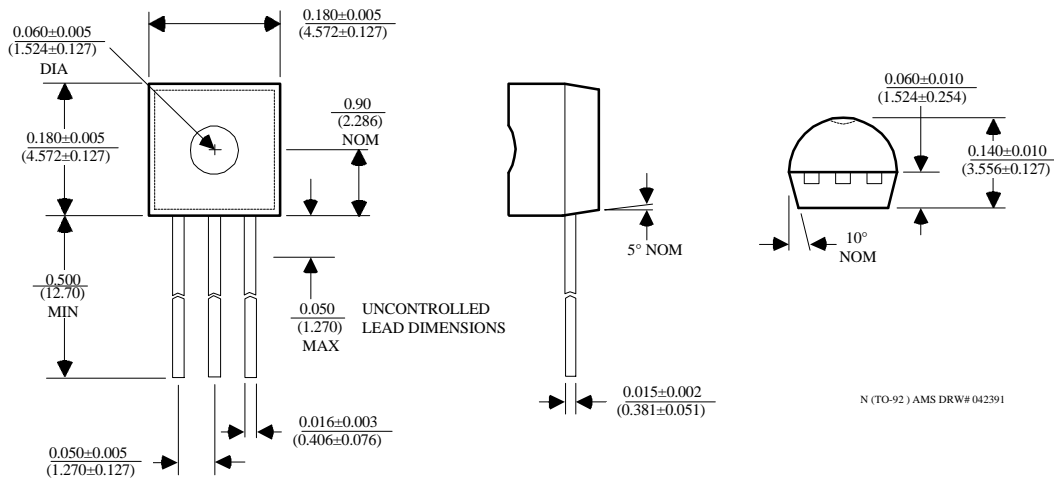

PACKAGE DIMENSIONS inches (millimeters) unless otherwise noted (Continued).

8 LEAD SOIC PLASTIC PACKAGE (S)

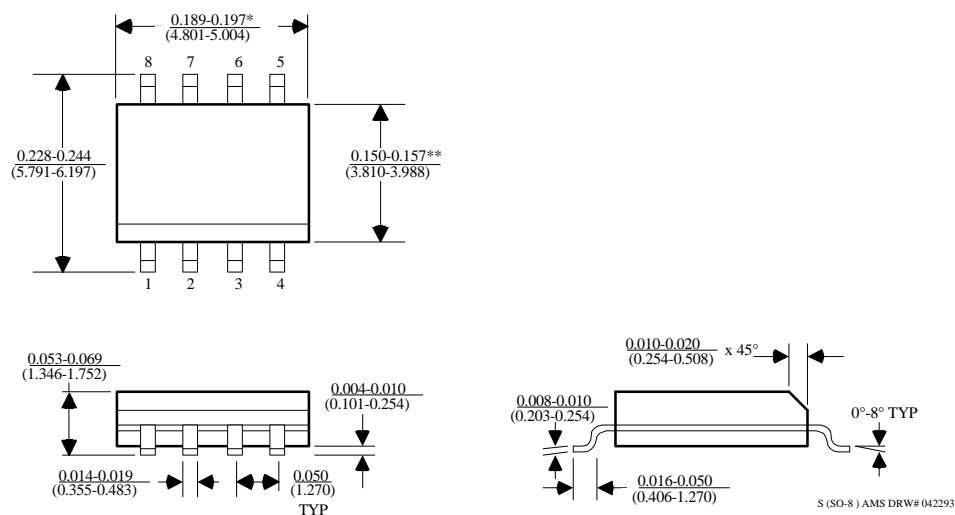

*DIMENSION DOES NOT INCLUDE MOLD FLASH. MOLD FLASH SHALL NOT EXCEED 0.006" (0.152mm) PER SIDE

**DIMENSION DOES NOT INCLUDE INTERLEAD FLASH. INTERLEAD FLASH SHALL NOT EXCEED 0.010" (0.254mm) PER SIDE

SOT-89 PLASTIC PACKAGE (L)

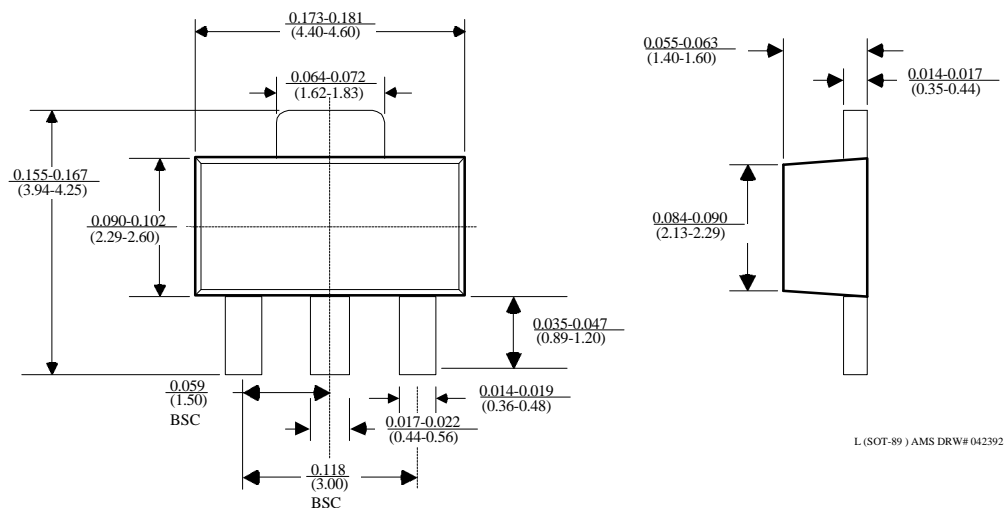

PACKAGE DIMENSIONS inches (millimeters) unless otherwise noted (Continued).

3 LEAD SOT-23 PLASTIC PACKAGE (M)

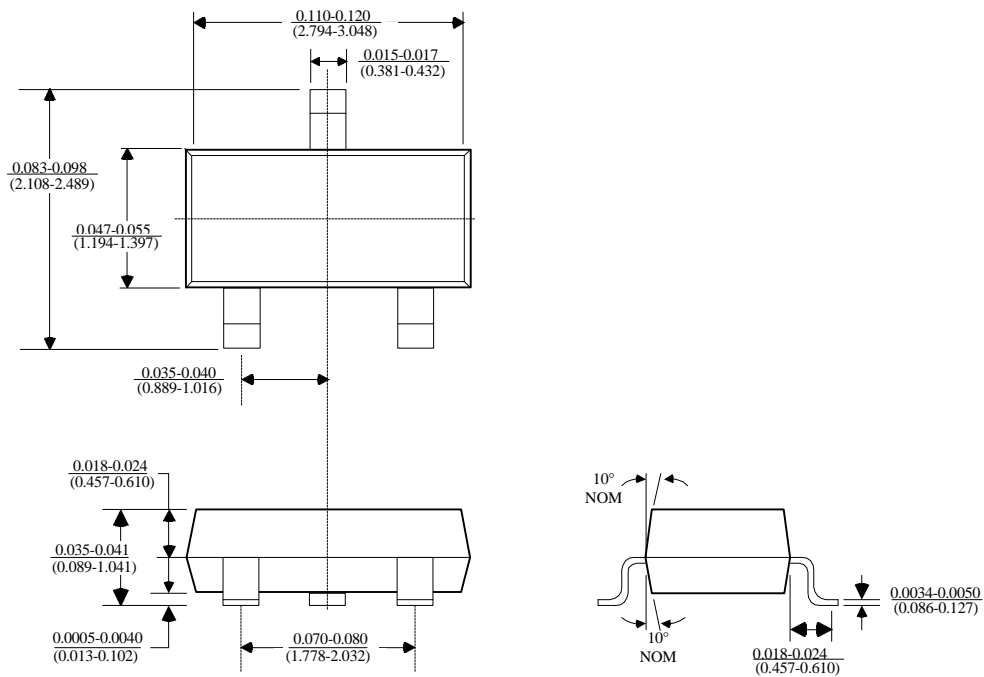

(SOT-23) AMS DRW# 051991