

AN5371NS, AN5379NS

RGB Signal Output IC for LCD TV

Overview

The AN5371NS and the AN5379NS are RGB signal output ICs for LCD TV. They can also output texts to be displayed. They can be directly connected to a signal processor IC of AN5372S. The AN5371NS is normal black, and the AN5379NS is normal white. Select one of them according to the LCD-type of a TV.

Features

- Low operating voltage : $V_{CC1}=5V$, and $V_{CC2}=10V$ typ.
- Including a brightness control circuit
- Gain and DC adjustment available for R and B signals (G signal is the reference)
- Responding to text input (RGB)
- Common-voltage output

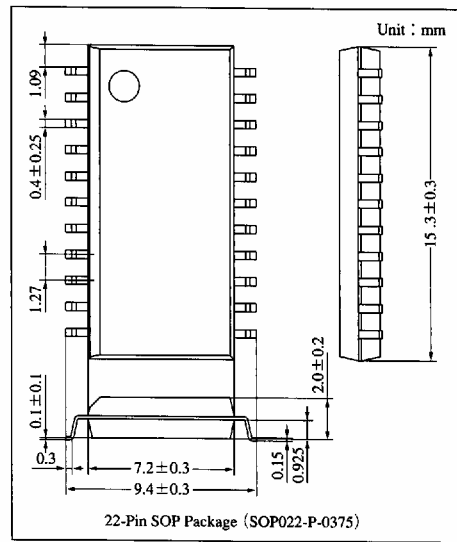

Block Diagram

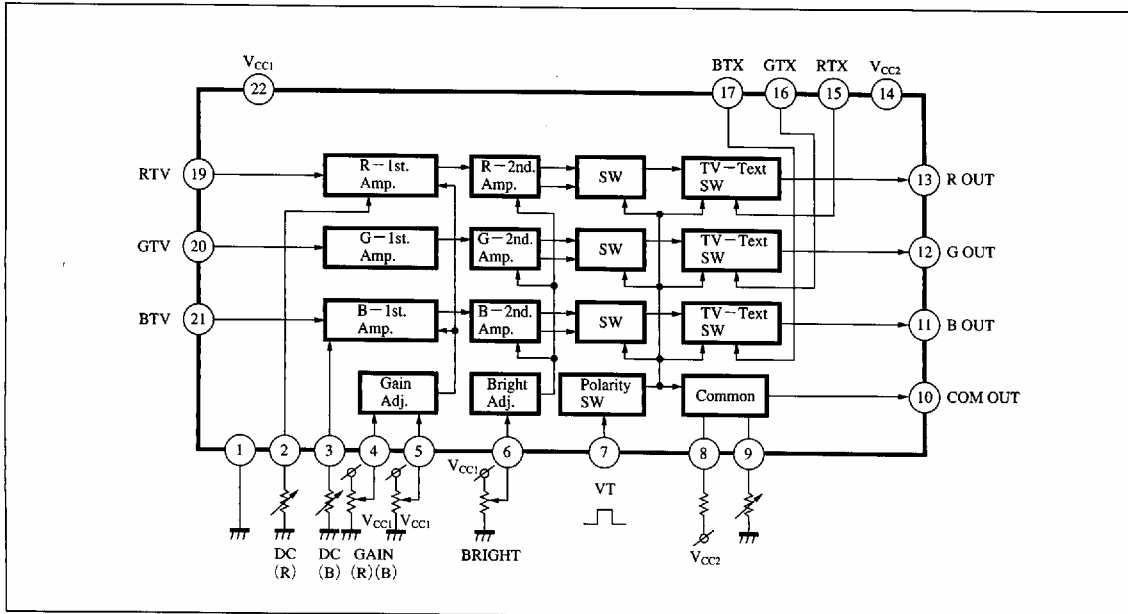

Pin Descriptions

Pin No.	Pin name	Pin No.	Pin name
1	GND	12	G output
2	R adjustment	13	R output
3	B adjustment	14	Power supply ($V_{CC2}=10V$)
4	R voltage gain adj.	15	R _{TX} input
5	B voltage gain adj.	16	G _{TX} input
6	Brightness adjustment	17	B _{TX} input
7	Polarity switching	18	NC
8	Common voltage high level input	19	R input
9	Common voltage low level input	20	G input
10	Common voltage output	21	B input
11	B output	22	Power supply ($V_{CC1}=5V$)

Absolute Maximum Ratings

Parameter	Symbol	Rating	Unit
Supply voltage	V_{CC}	$V_{22}=5.5$	V
		$V_{14}=11.0$	
Supply current	I_{CC}	$I_{22}=5$	mA
		$I_{14}=20$	
Power dissipation	P_D	247.5 *	mW
Operating ambient temperature ^{Note)}	T_{opr}	-20 to +70	°C
Storage temperature ^{Note)}	T_{stg}	-55 to +125	°C

Note) $T_a=25^{\circ}C$ except operating ambient temperature and storage temperature.

* For AN5371NS, the value at $P_D=500mW$

Recommended Operating Range ($T_a=25^{\circ}C$)

Parameter	Symbol	Range
Operating supply voltage range	V_{CC}	V_{22} 4.55V to 5.45V
		V_{14} 9.1V to 10.9V *

* For AN5371NS, the value at $V_{14}=9.5$ to 10.9V