

General Description

The AOT14N50 & AOB14N50 & AOTF14N50 have been fabricated using an advanced high voltage MOSFET process that is designed to deliver high levels of performance and robustness in popular AC-DC applications. By providing low $R_{DS(on)}$, C_{iss} and C_{rss} along with guaranteed avalanche capability these parts can be adopted quickly into new and existing offline power supply designs.

Features

| | |
|---------------------------------|------------|
| V_{DS} | 600V@150°C |
| I_D (at $V_{GS}=10V$) | 14A |
| $R_{DS(ON)}$ (at $V_{GS}=10V$) | < 0.38Ω |

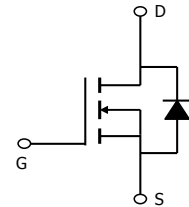

Absolute Maximum Ratings $T_A=25^\circ\text{C}$ unless otherwise noted

| Parameter | Symbol | AOT14N50/AOB14N50 | AOTF14N50 | Units |
|--|----------------|-------------------------|-----------|-------|
| Drain-Source Voltage | V_{DS} | 500 | | V |
| Gate-Source Voltage | V_{GS} | ±30 | | V |
| Continuous Drain Current | I_D | $T_C=25^\circ\text{C}$ | 14 | 14* |
| | | $T_C=100^\circ\text{C}$ | 11 | 11* |
| Pulsed Drain Current ^C | I_{DM} | 56 | | A |
| Avalanche Current ^C | I_{AR} | 6 | | A |
| Repetitive avalanche energy ^C | E_{AR} | 540 | | mJ |
| Single plused avalanche energy ^G | E_{AS} | 1080 | | mJ |
| Peak diode recovery dv/dt | dv/dt | 5 | | V/ns |
| Power Dissipation ^B | P_D | $T_C=25^\circ\text{C}$ | 278 | 50 |
| | | Derate above 25°C | 2.2 | 0.4 |
| Junction and Storage Temperature Range | T_J, T_{STG} | -55 to 150 | | °C |
| Maximum lead temperature for soldering purpose, 1/8" from case for 5 seconds | T_L | 300 | | °C |

Thermal Characteristics

| Parameter | Symbol | AOT14N50/AOB14N50 | AOTF14N50 | Units |
|--|-----------------|-------------------|-----------|-------|
| Maximum Junction-to-Ambient ^{A,D} | $R_{\theta JA}$ | 65 | 65 | °C/W |
| Maximum Case-to-sink ^A | $R_{\theta CS}$ | 0.5 | -- | °C/W |
| Maximum Junction-to-Case | $R_{\theta JC}$ | 0.45 | 2.5 | °C/W |

* Drain current limited by maximum junction temperature.

Electrical Characteristics (T_J=25°C unless otherwise noted)

| Symbol | Parameter | Conditions | Min | Typ | Max | Units |
|------------------------------------|---------------------------------------|---|------|------|---------|-------|
| STATIC PARAMETERS | | | | | | |
| BV _{DSS} | Drain-Source Breakdown Voltage | I _D =250μA, V _{GS} =0V, T _J =25°C I _D =250μA, V _{GS} =0V, T _J =150°C | 500 | | | V |
| BV _{DSS} /ΔT _J | Zero Gate Voltage Drain Current | I _D =250μA, V _{GS} =0V | | 0.5 | | V/°C |
| I _{DSS} | Zero Gate Voltage Drain Current | V _{DS} =500V, V _{GS} =0V V _{DS} =400V, T _J =125°C | | | 1 10 | μA |
| I _{GSS} | Gate-Body leakage current | V _{DS} =0V, V _{GS} =±30V | | | ±100 | nA |
| V _{GS(th)} | Gate Threshold Voltage | V _{DS} =5V, I _D =250μA | 3.3 | 4.2 | 4.5 | V |
| R _{DS(ON)} | Static Drain-Source On-Resistance | V _{GS} =10V, I _D =7A | | 0.29 | 0.38 | Ω |
| g _{FS} | Forward Transconductance | V _{DS} =40V, I _D =7A | | 20 | | S |
| V _{SD} | Diode Forward Voltage | I _S =1A, V _{GS} =0V | | 0.71 | 1 | V |
| I _S | Maximum Body-Diode Continuous Current | | | | 14 | A |
| I _{SM} | Maximum Body-Diode Pulsed Current | | | | 56 | A |
| DYNAMIC PARAMETERS | | | | | | |
| C _{iss} | Input Capacitance | V _{GS} =0V, V _{DS} =25V, f=1MHz | 1531 | 1914 | 2297 | pF |
| C _{oss} | Output Capacitance | | 153 | 191 | 229 | pF |
| C _{rss} | Reverse Transfer Capacitance | | 11 | 16 | 20 | pF |
| R _g | Gate resistance | V _{GS} =0V, V _{DS} =0V, f=1MHz | 1.75 | 3.5 | 5.3 | Ω |
| SWITCHING PARAMETERS | | | | | | |
| Q _g | Total Gate Charge | V _{GS} =10V, V _{DS} =400V, I _D =14A | | 42.8 | 51 | nC |
| Q _{gs} | Gate Source Charge | | 9.3 | 11 | nC | |
| Q _{gd} | Gate Drain Charge | | 20.3 | 24 | nC | |
| t _{D(on)} | Turn-On DelayTime | V _{GS} =10V, V _{DS} =250V, I _D =14A, R _G =25Ω | | 44 | 53 | ns |
| t _r | Turn-On Rise Time | | 84 | 101 | ns | |
| t _{D(off)} | Turn-Off DelayTime | | 92 | 110 | ns | |
| t _f | Turn-Off Fall Time | | 50 | 60 | ns | |
| t _{rr} | Body Diode Reverse Recovery Time | I _F =14A, di/dt=100A/μs, V _{DS} =100V | | 289 | 347 | ns |
| Q _{rr} | Body Diode Reverse Recovery Charge | I _F =14A, di/dt=100A/μs, V _{DS} =100V | | 4.93 | 6 | μC |

A. The value of R_{θJA} is measured with the device in a still air environment with T_A=25°C.

B. The power dissipation P_D is based on T_{J(MAX)}=150°C, using junction-to-case thermal resistance, and is more useful in setting the upper dissipation limit for cases where additional heatsinking is used.

C. Repetitive rating, pulse width limited by junction temperature T_{J(MAX)}=150°C, Ratings are based on low frequency and duty cycles to keep initial T_J=25°C.

D. The R_{θJA} is the sum of the thermal impedance from junction to case R_{θJC} and case to ambient.

E. The static characteristics in Figures 1 to 6 are obtained using <300 μs pulses, duty cycle 0.5% max.

F. These curves are based on the junction-to-case thermal impedance which is measured with the device mounted to a large heatsink, assuming a maximum junction temperature of T_{J(MAX)}=150°C. The SOA curve provides a single pulse rating g.

G. L=60mH, I_{AS}=6A, V_{DD}=150V, R_G=25Ω, Starting T_J=25°C

TYPICAL ELECTRICAL AND THERMAL CHARACTERISTICS

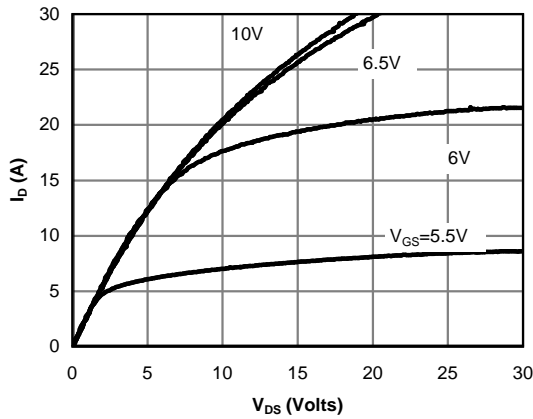

Fig 1: On-Region Characteristics

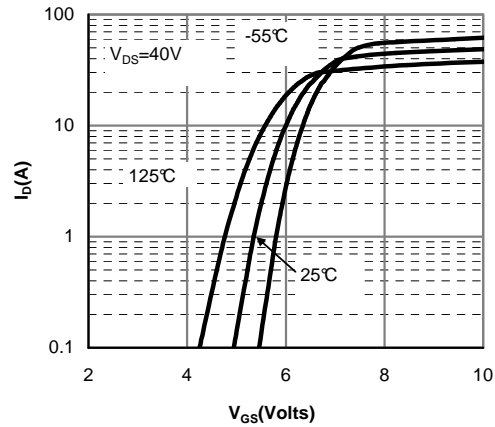

Figure 2: Transfer Characteristics

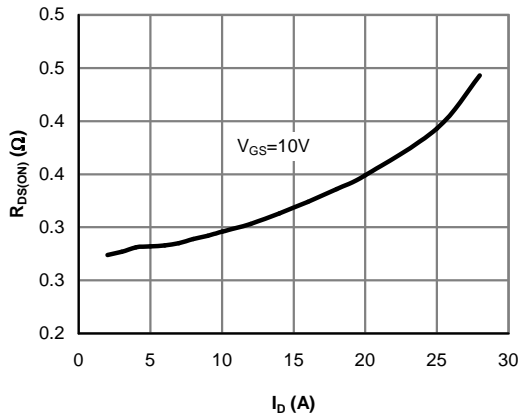

Figure 3: On-Resistance vs. Drain Current and Gate Voltage

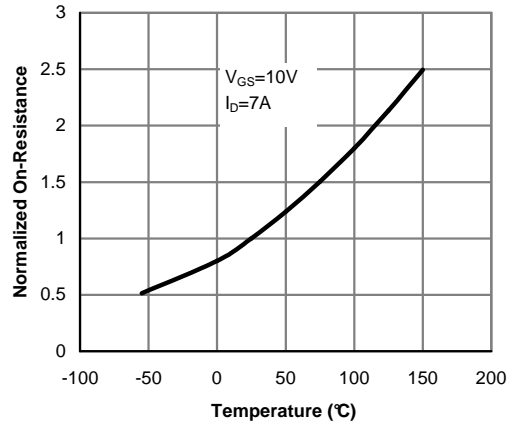

Figure 4: On-Resistance vs. Junction Temperature

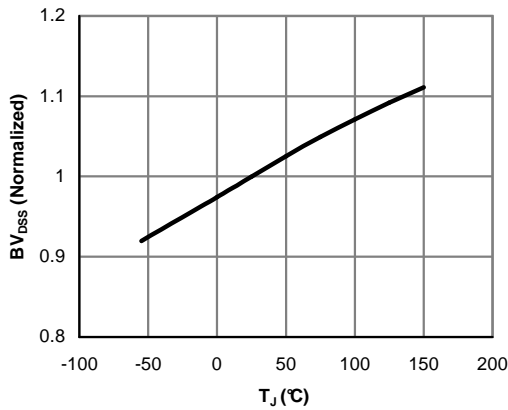

Figure 5: Break Down vs. Junction Temperature

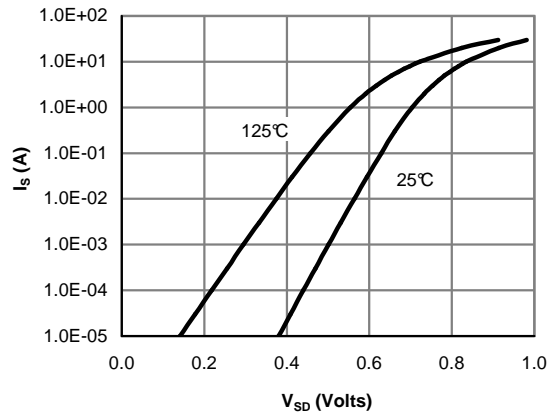

Figure 6: Body-Diode Characteristics (Note E)

TYPICAL ELECTRICAL AND THERMAL CHARACTERISTICS

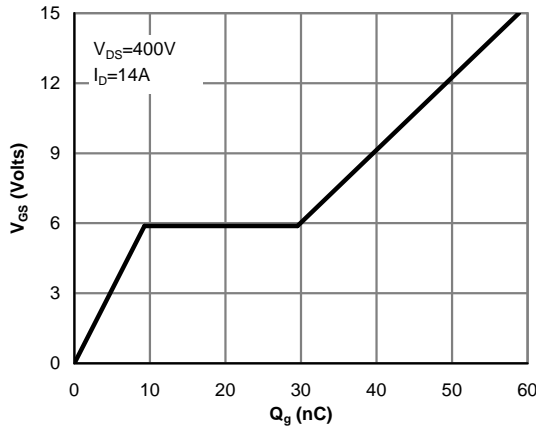

Figure 7: Gate-Charge Characteristics

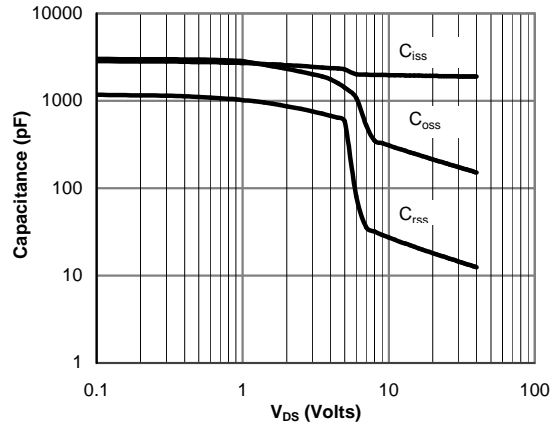

Figure 8: Capacitance Characteristics

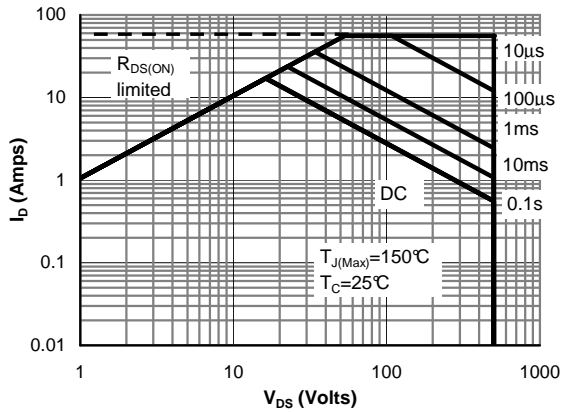

Figure 9: Maximum Forward Biased Safe Operating Area for AOT14N50/AOB14N50 (Note F)

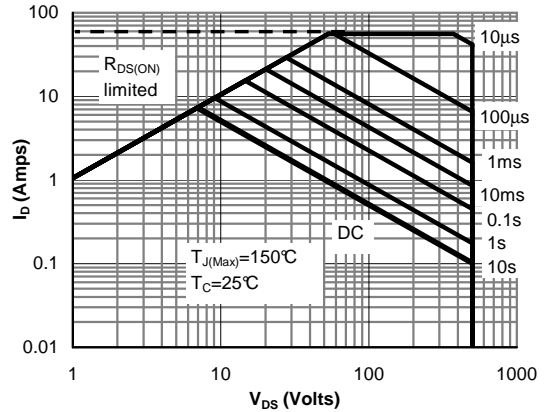

Figure 10: Maximum Forward Biased Safe Operating Area for AOTF14N50 (Note F)

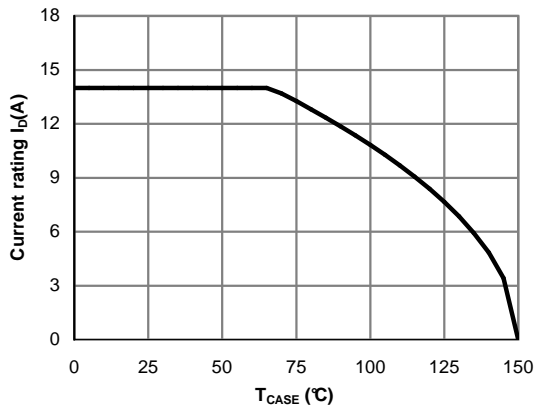

Figure 11: Current De-rating (Note B)

TYPICAL ELECTRICAL AND THERMAL CHARACTERISTICS

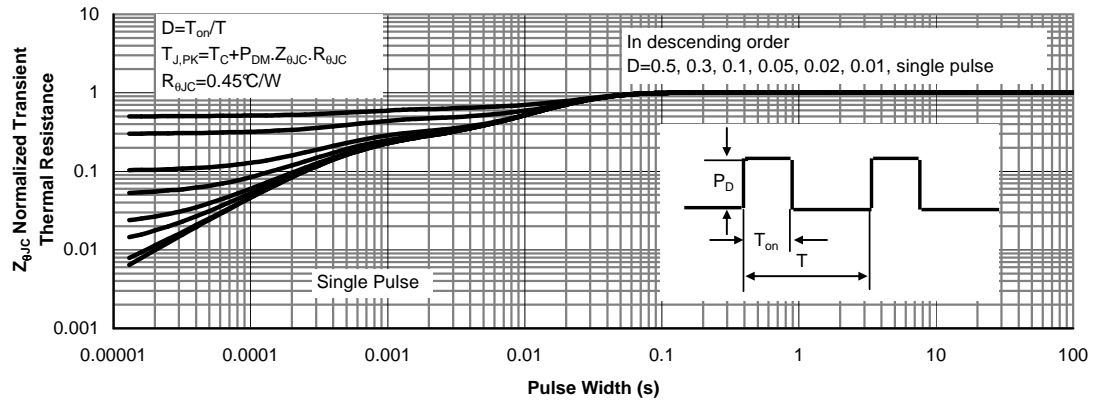

Figure 12: Normalized Maximum Transient Thermal Impedance for AOT14N50/AOB14N50 (Note F)

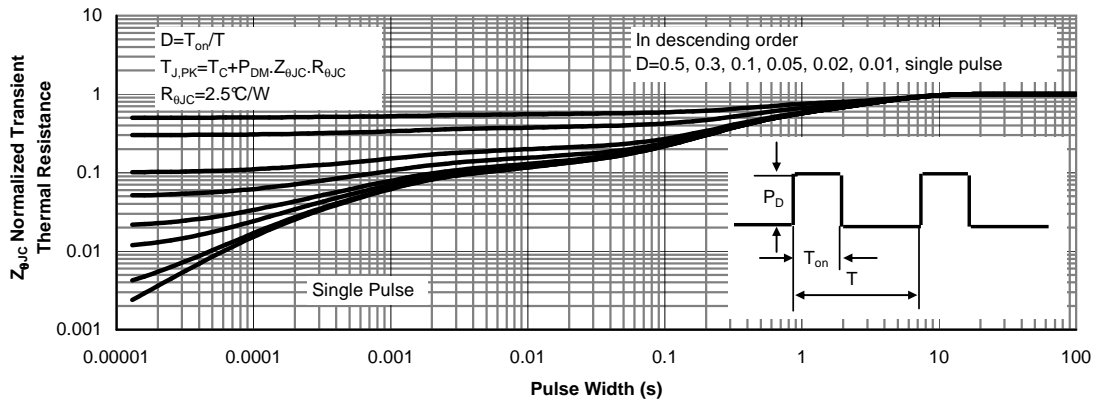
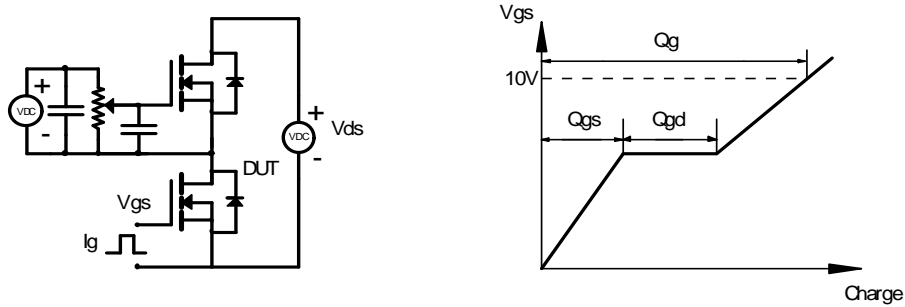
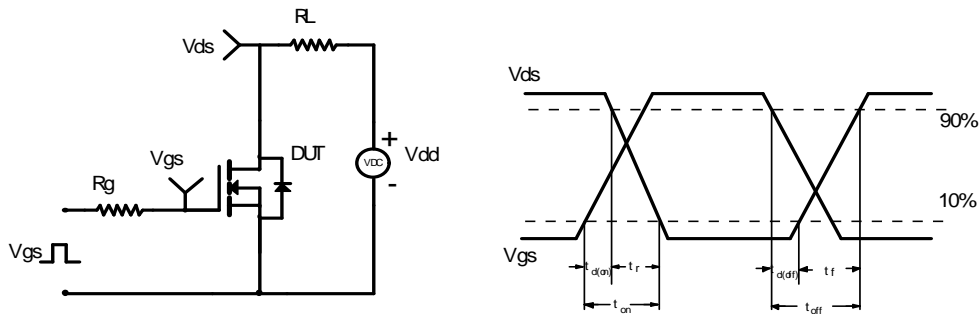

Figure 13: Normalized Maximum Transient Thermal Impedance for AOTF14N50 (Note F)

Gate Charge Test Circuit & Waveform



Resistive Switching Test Circuit & Waveforms



Unclamped Inductive Switching (UIS) Test Circuit & Waveforms

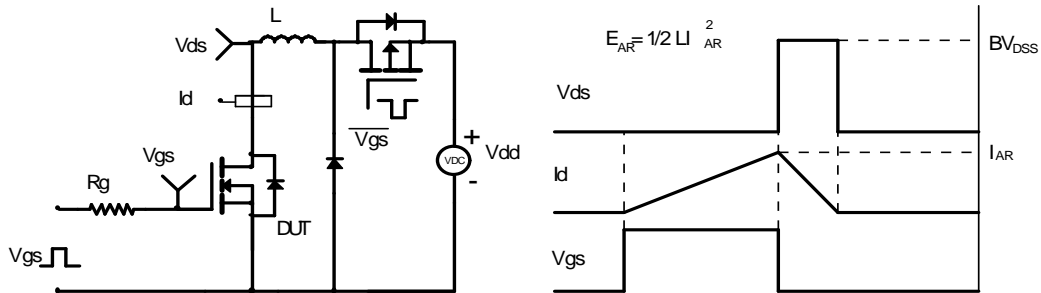

Diode Recovery Test Circuit & Waveforms

