



General Description

The AP2126 is a 300mA, positive Voltage regulator ICs fabricated by CMOS process.

Each of AP2126 is equipped with a voltage reference, an error amplifier, a resistor network for setting output voltage, a chip enable circuit, a current limit circuit and OSTD (over temperature shut down) circuit to prevent the IC from over current and over temperature.

The AP2126 has features of high ripple rejection, low dropout voltage, low noise, high output voltage accuracy, and low current consumption which make it ideal for use in various battery-powered apparatus.

AP2126 has 3.3V fixed voltage version. It is available in SOT-23-5 Package.

Features

- Low Dropout Voltage: 170mV@300mA
- High Output Voltage Accuracy: $\pm 2\%$
- High Ripple Rejection:
65dB@ f=1kHz, 45dB@ f=10kHz
- Low Standby Current: 0.1 μ A
- Low Quiescent Current: 60 μ A Typical
- Low Output Noise: 60 μ Vrms
- Short Current Limit: 50mA
- Over Temperature Protection
- Compatible with Low ESR Ceramic Capacitor:
1 μ F for C_{IN} and C_{OUT}
- Excellent Line/Load Regulation
- Soft Start Time: 50 μ s
- Auto Discharge Resistance: R_{DS(ON)}=60 Ω

Applications

- Datacom
- Notebook Computers
- Mother Board

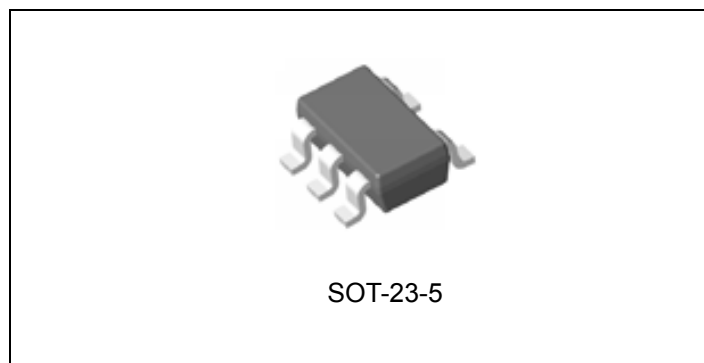

Figure 1. Package Type of AP2126

Pin Configuration

K Package
(SOT-23-5)

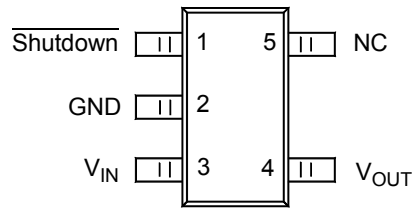

Figure 2. Pin Configuration of AP2126 (Top View)

Functional Block Diagram

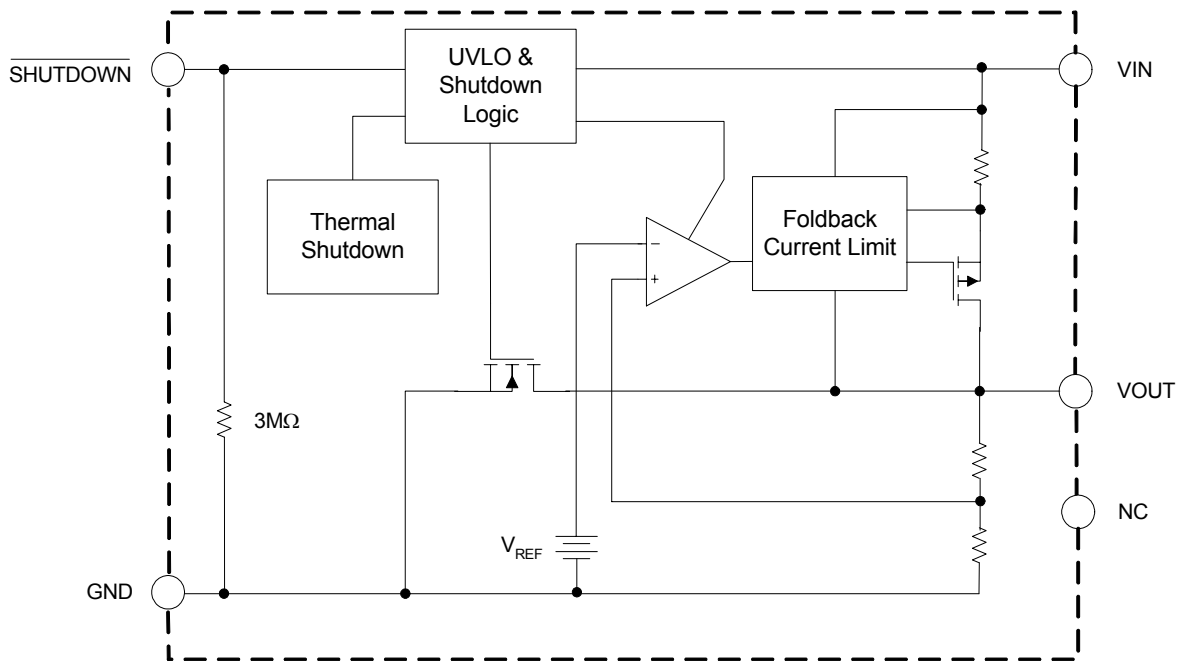
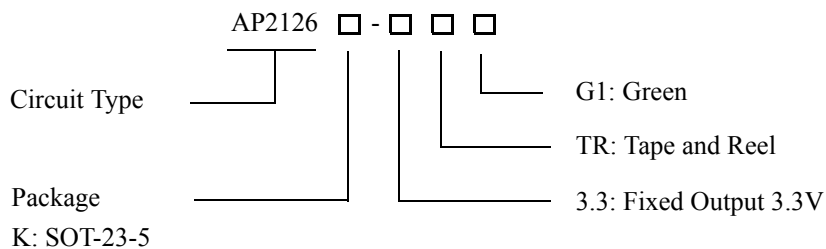

Figure 3. Functional Block Diagram of AP2126



300mA HIGH SPEED, EXTREMELY LOW NOISE CMOS LDO REGULATOR AP2126

Ordering Information



Product	Package	Temperature Range	Part Number	Marking ID	Packing Type
			Green	Green	
AP2126	SOT-23-5	-40 to 85°C	AP2126K-3.3TRG1	FEF	Tape & Reel

BCD Semiconductor's products, as designated with "G1" suffix in the part number, are RoHS compliant and Green.

**300mA HIGH SPEED, EXTREMELY LOW NOISE CMOS LDO REGULATOR****AP2126****Absolute Maximum Ratings (Note 1)**

Parameter	Symbol	Value	Unit
Input Voltage	V_{IN}	6.5	V
Shutdown Input Voltage	V_{CE}	-0.3 to $V_{IN}+0.3$	V
Output Current	I_{OUT}	450	mA
Junction Temperature	T_J	150	°C
Storage Temperature Range	T_{STG}	-65 to 150	°C
Lead Temperature (Soldering, 10sec)	T_{LEAD}	260	°C
Thermal Resistance	$R_{\theta JA}$	250	°C/W
ESD (Human Body Model)	ESD	6000	V
ESD (Machine Model)	ESD	300	V

Note 1: Stresses greater than those listed under "Absolute Maximum Ratings" may cause permanent damage to the device. These are stress ratings only, and functional operation of the device at these or any other conditions beyond those indicated under "Recommended Operating Conditions" is not implied. Exposure to "Absolute Maximum Ratings" for extended periods may affect device reliability.

Recommended Operating Conditions

Parameter	Symbol	Min	Max	Unit
Input Voltage	V_{IN}	-	6	V
Operating Junction Temperature Range	T_J	-40	85	°C



300mA HIGH SPEED, EXTREMELY LOW NOISE CMOS LDO REGULATOR AP2126

Electrical Characteristics (Continued)

(AP2126-3.3V, C_{IN}=1μF, C_{OUT}=1μF, Bold typeface applies over -40°C≤T_J≤85°C, unless otherwise specified.)

Parameter	Symbol	Conditions	Min	Typ	Max	Unit
Output Voltage	V _{OUT}	V _{IN} =V _{OUT} +1V 1mA≤I _{OUT} ≤300mA	98%* V _{OUT}		102%* V _{OUT}	V
Input Voltage	V _{IN}				6	V
Maximum Output Current	I _{OUT(MAX)}			450		mA
Load Regulation	$\frac{\Delta V_{OUT}}{(\Delta I_{OUT} * V_{OUT})}$	V _{IN} -V _{OUT} =1V, 1mA≤I _{OUT} ≤300mA			0.6	%/A
Line Regulation	$\frac{\Delta V_{OUT}}{(\Delta V_{IN} * V_{OUT})}$	V _{OUT} +0.5V≤V _{IN} ≤6V I _{OUT} =30mA			0.06	%/V
Dropout Voltage	V _{DROP}	V _{OUT} =3.3V, I _{OUT} =300mA		170	300	mV
Quiescent Current	I _Q	V _{IN} =V _{OUT} +1V, I _{OUT} =0mA		60	90	μA
Standby Current	I _{STD}	V _{IN} =V _{OUT} +1V, V _{SHUTDOWN} in off mode		0.1	1.0	μA
Power Supply Rejection Ratio	PSRR	Ripple 1Vp-p V _{IN} =V _{OUT} +1V	f=100Hz		65	dB
			f=1KHz		65	dB
			f=10KHz		45	dB
Output Voltage Temperature Coefficient	$\frac{(\Delta V_{OUT}/V_{OUT})}{\Delta T}$	I _{OUT} =30mA, -40°C≤T _J ≤85°C		±100		ppm/°C
Output Current Limit	I _{LIMIT}	V _{IN} -V _{OUT} =1V, V _{OUT} =0.98*V _{OUT}		400		mA
Short Current Limit	I _{SHORT}	V _{OUT} =0V		50		mA
Soft Start Time	t _{UP}			50		μs
RMS Output Noise	V _{NOISE}	T _A =25°C, 10Hz≤f≤100kHz		60		μVrms
Shutdown "High" Voltage		Shutdown input voltage "High"	1.5		6	V
Shutdown "Low" Voltage		Shutdown input voltage "Low"	0		0.4	V
V _{OUT} Discharge MOSFET R _{DS(ON)}		Shutdown input voltage "Low"		60		Ω
Shutdown Pull Down Resistance				3		MΩ
Thermal Shutdown				165		°C
Thermal Shutdown Hysteresis				30		°C



300mA HIGH SPEED, EXTREMELY LOW NOISE CMOS LDO REGULATOR AP2126

Typical Performance Characteristics

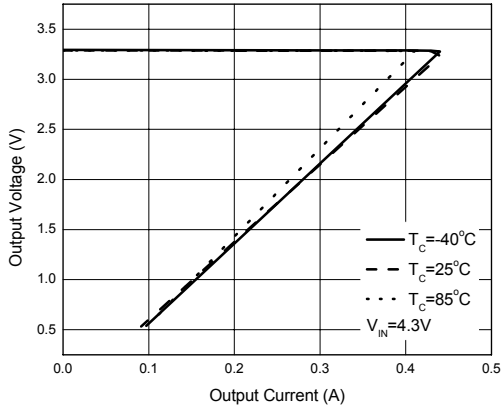

Figure 4. Output Voltage vs. Output Current

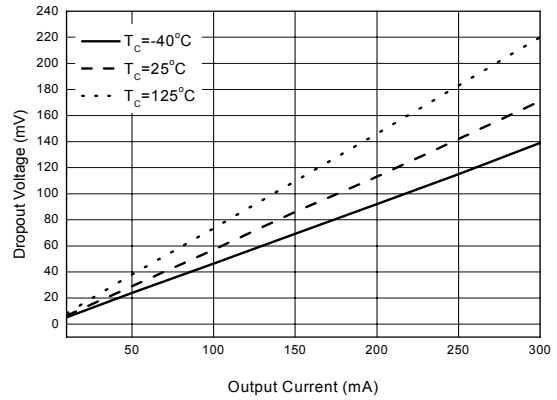

Figure 5. Dropout Voltage vs. Output Current, $V_{OUT}=3.3V$

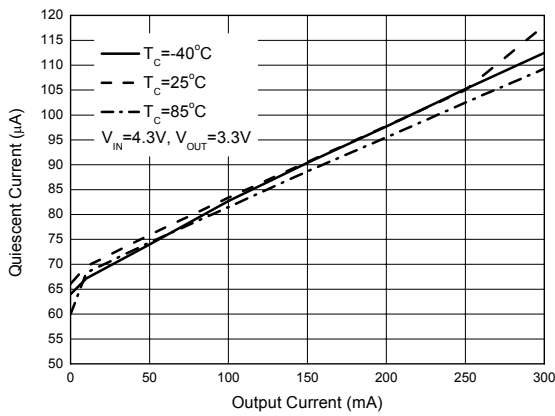

Figure 6. Quiescent Current vs. Output Current

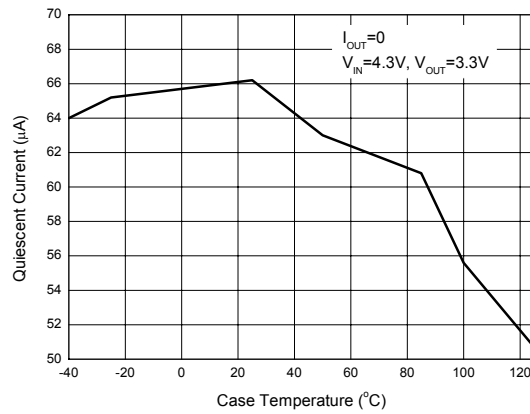

Figure 7. Quiescent Current vs. Case Temperature



300mA HIGH SPEED, EXTREMELY LOW NOISE CMOS LDO REGULATOR AP2126

Typical Performance Characteristics (Continued)

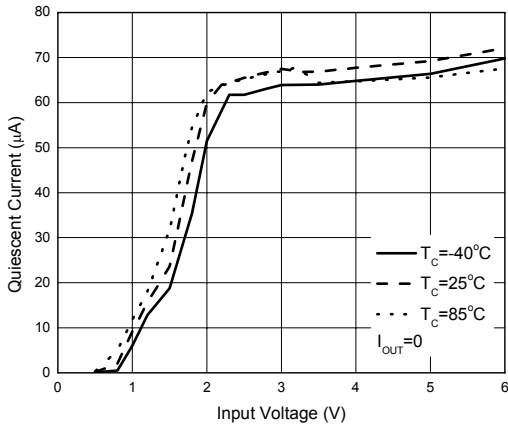

Figure 8. Quiescent Current vs. Input Voltage

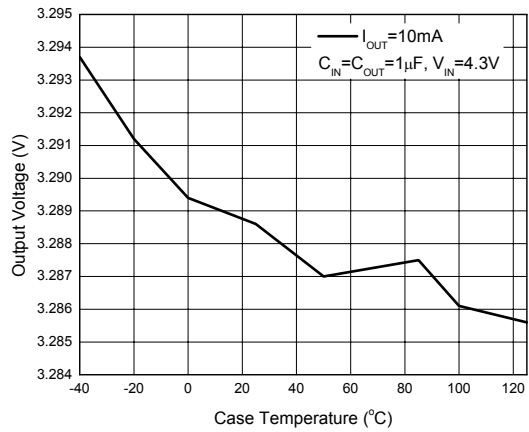

Figure 9. Output Voltage vs. Case Temperature

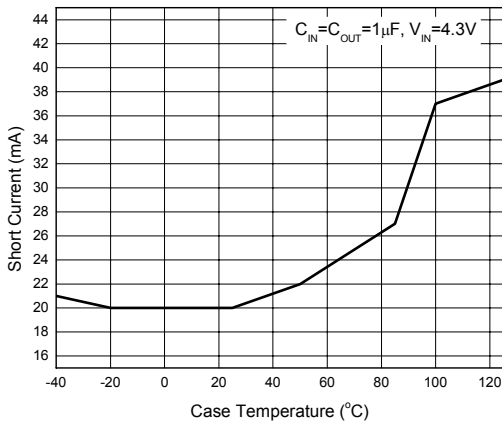

Figure 10. Short Current vs. Case Temperature

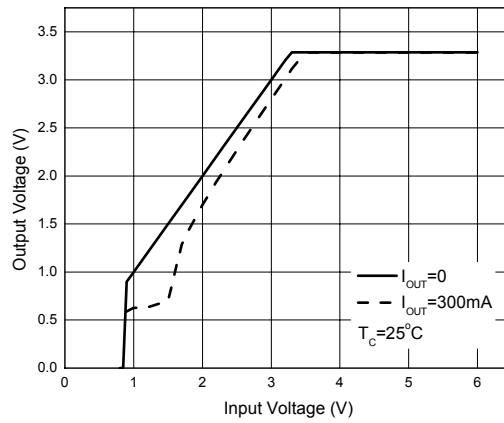

Figure 11. Output Voltage vs. Input Voltage



300mA HIGH SPEED, EXTREMELY LOW NOISE CMOS LDO REGULATOR AP2126

Typical Performance Characteristics (Continued)

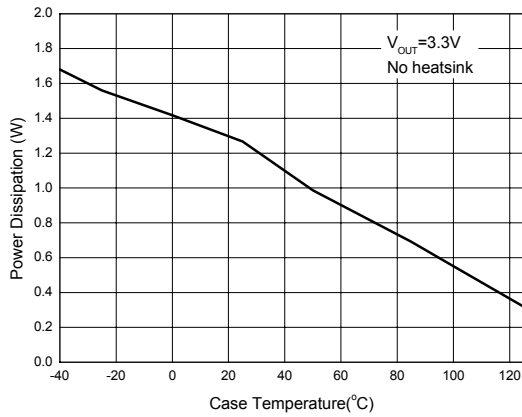

Figure 12. Power Dissipation vs. Case Temperature

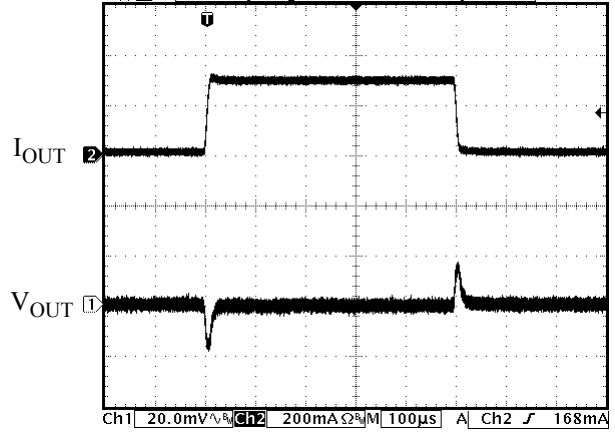

Figure 13. Load Transient
(Conditions: $C_{IN}=C_{OUT}=1\mu F$, $V_{IN}=4.4V$, $V_{OUT}=3.3V$)

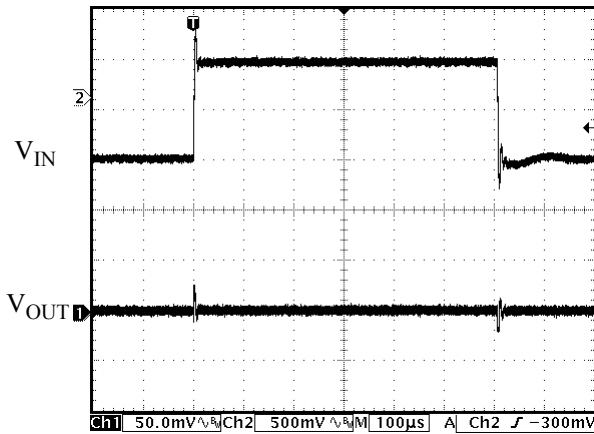

Figure 14. Line Transient
(Conditions: $I_{OUT}=30mA$, $C_{IN}=C_{OUT}=1\mu F$,
 $V_{IN}=4$ to $5V$, $V_{OUT}=3.3V$)

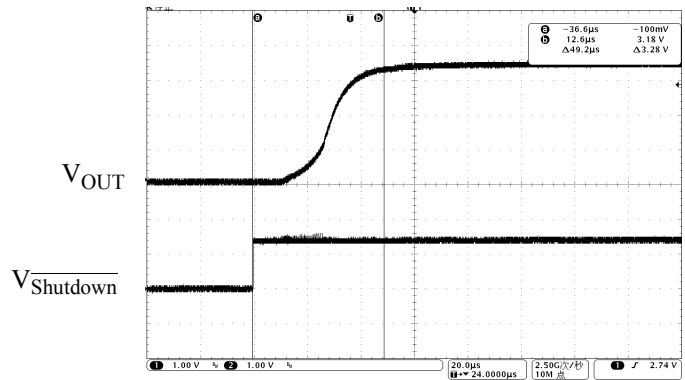

Figure 15. Soft Start Time
(Conditions: $I_{OUT}=0mA$, $C_{IN}=C_{OUT}=1\mu F$,
 $V_{Shutdown}=0$ to $2V$, $V_{OUT}=3.3V$)



Typical Performance Characteristics (Continued)

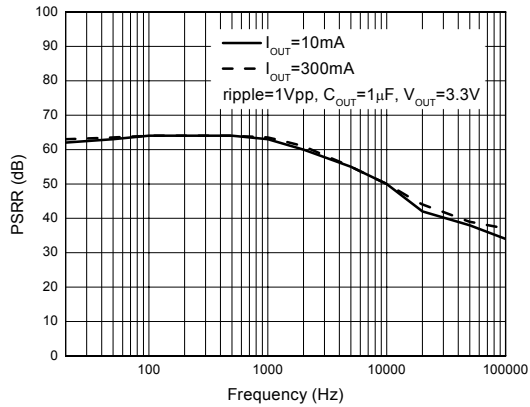

Figure 16. PSRR vs. Frequency

Typical Application

Figure 17. Typical Application of AP2126



300mA HIGH SPEED, EXTREMELY LOW NOISE CMOS LDO REGULATOR AP2126

Mechanical Dimensions

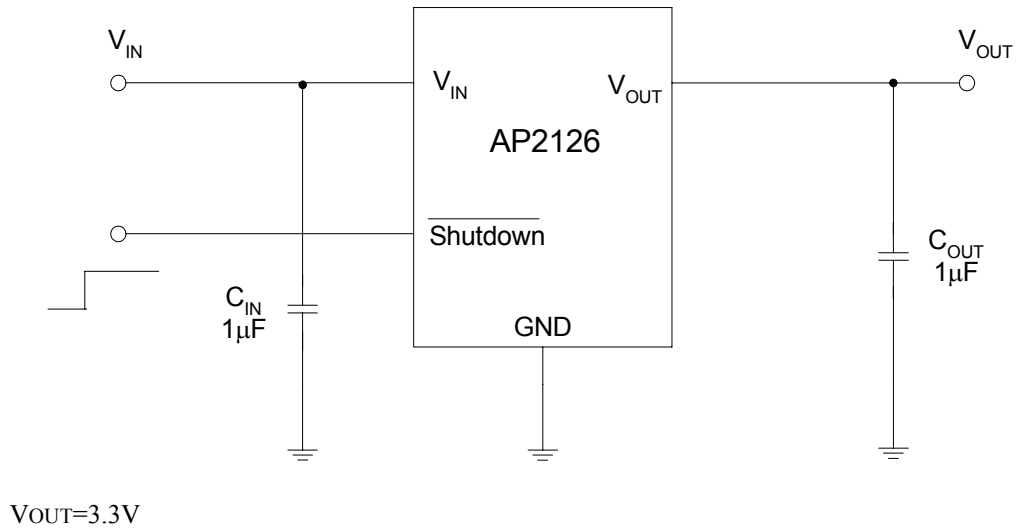
SOT-23-5

Unit: mm(inch)

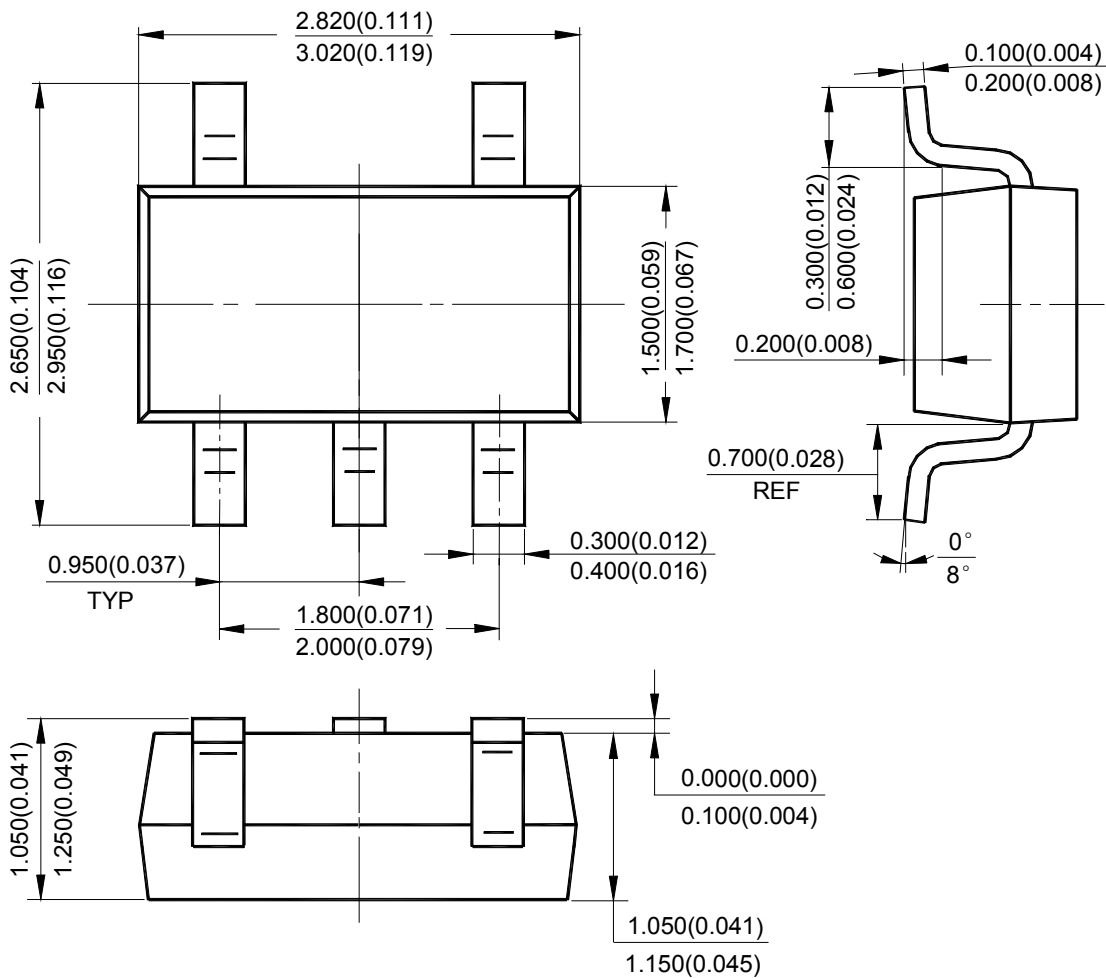



BCD Semiconductor Manufacturing Limited

<http://www.bcdsemi.com>

IMPORTANT NOTICE

BCD Semiconductor Manufacturing Limited reserves the right to make changes without further notice to any products or specifications herein. BCD Semiconductor Manufacturing Limited does not assume any responsibility for use of any its products for any particular purpose, nor does BCD Semiconductor Manufacturing Limited assume any liability arising out of the application or use of any its products or circuits. BCD Semiconductor Manufacturing Limited does not convey any license under its patent rights or other rights nor the rights of others.

MAIN SITE

- Headquarters

BCD Semiconductor Manufacturing Limited

No. 1600, Zi Xing Road, Shanghai Zizhu Science-based Industrial Park, 200241, China
Tel: +86-21-24162266, Fax: +86-21-24162277

- Wafer Fab

Shanghai SIM-BCD Semiconductor Manufacturing Co., Ltd.

800 Yi Shan Road, Shanghai 200233, China
Tel: +86-21-6485 1491, Fax: +86-21-5450 0008

REGIONAL SALES OFFICE

Shenzhen Office

Shanghai SIM-BCD Semiconductor Manufacturing Co., Ltd., Shenzhen Office
Room E, 5F, Noble Center, No.1006, 3rd Fuzhong Road, Futian District, Shenzhen,
518026, China
Tel: +86-755-8826 7951
Fax: +86-755-8826 7865

Taiwan Office

BCD Semiconductor (Taiwan) Company Limited
4F, 298-1, Rui Guang Road, Nei-Hu District, Taipei,
Taiwan
Tel: +886-2-2656 2808
Fax: +886-2-2656 2806

USA Office

BCD Semiconductor Corp.
30920 Huntwood Ave. Hayward,
CA 94544, USA
Tel : +1-510-324-2988
Fax: +1-510-324-2788