

**1A LOW DROPOUT LINEAR REGULATOR****AP2218****General Description**

The AP2218 is a low dropout linear regulator with a typical dropout of 300mV at 1A output current.

The AP2218 provides current limit and thermal shutdown. On-chip thermal shutdown provides protection against any combination of high current and ambient temperature that would create excessive junction temperatures.

The AP2218 has 3.3V and 5.0V versions.

The AP2218 is available in the industry standard TO-220F-4 package.

Features

- Minimum Guaranteed Output Current: 1A
- Dropout Voltage at $I_{OUT}=1A$: 300mV
- Output Accuracy: $\pm 1\%$
- Low Ground Current
- Internal Current Limit and Thermal Protection
- Reversed-battery and Reversed-lead Insertion Protection
- Fast Transient Response

Applications

- Power Module
- Set Top Box
- LCD TV
- PDP TV
- Cordless Phone

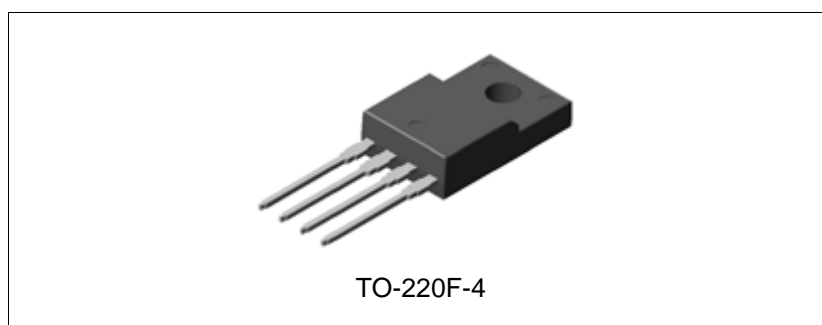

Figure 1. Package Type of AP2218

**1A LOW DROPOUT LINEAR REGULATOR****AP2218****Pin Configuration**T Package
(TO-220F-4)

Figure 2. Pin Configuration of AP2218 (Top View)

Pin Description

Pin Number	Pin Name	Function
1	V_{IN}	Unregulated Input.
2	V_{OUT}	Regulated Output.
3	GND	Ground pin. This pin and TAB are internally connected.
4	EN	Logic high enable input.

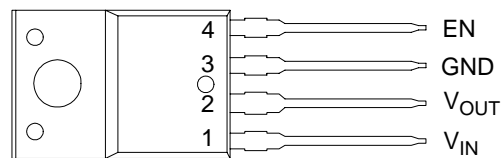

1A LOW DROPOUT LINEAR REGULATOR **AP2218**

Functional Block Diagram

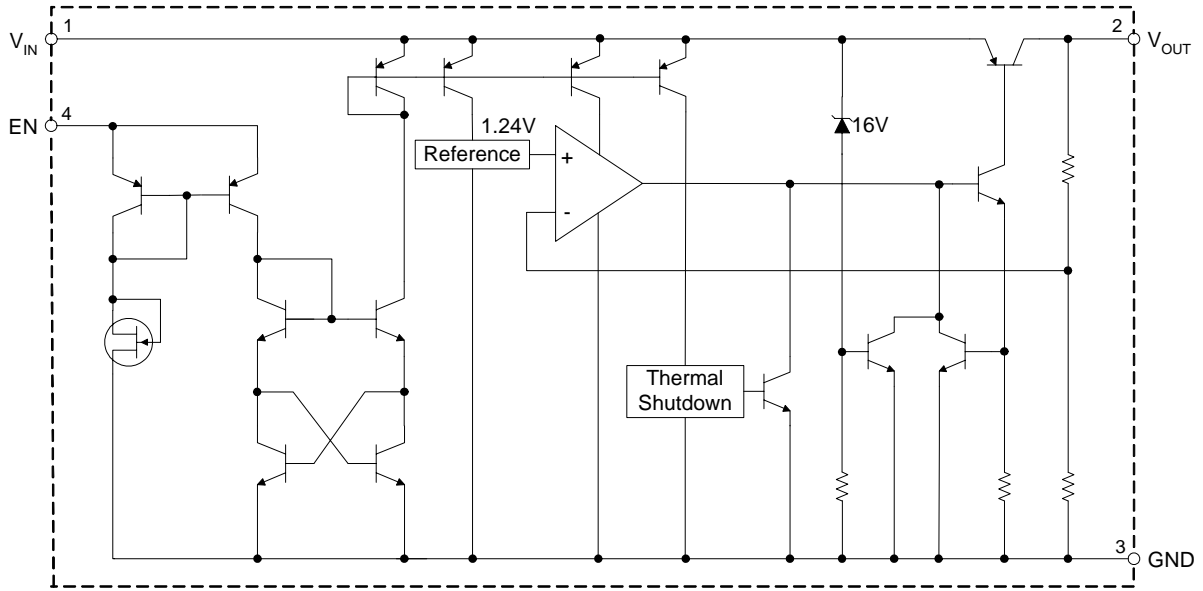
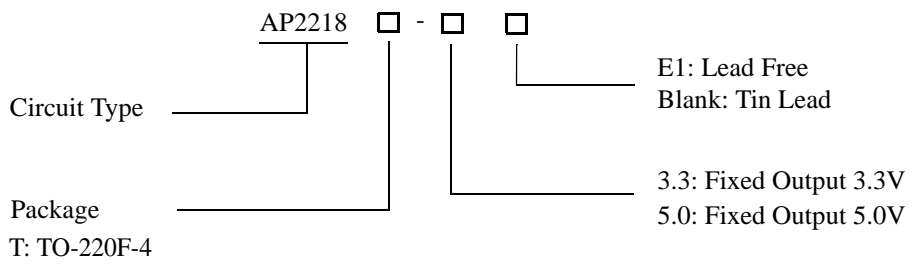

Figure 3. Functional Block Diagram of AP2218

Ordering Information



**1A LOW DROPOUT LINEAR REGULATOR****AP2218****Ordering Information (Continued)**

Package	Temperature Range	Part Number		Marking ID		Package Type
		Tin Lead	Lead Free	Tin Lead	Lead Free	
TO-220F-4	-40 to 125°C	AP2218T-3.3	AP2218T-3.3E1	AP2218T-3.3	AP2218T-3.3E1	Tube
		AP2218T-5.0	AP2218T-5.0E1	AP2218T-5.0	AP2218T-5.0E1	Tube

BCD Semiconductor's Pb-free products, as designated with "E1" suffix in the part number, are RoHS compliant.

Absolute Maximum Ratings (Note 1)

Parameter	Symbol	Value	Unit
Supply Voltage	V_{IN}	15	V
Maximum Operating Junction Temperature	T_J	150	°C
Storage Temperature Range	T_{STG}	-65 to 150	°C
Lead Temperature (Soldering, 10sec)	T_{LEAD}	300	°C
ESD (Machine Model)		350	V
ESD (Human Body Model)		2000	V

Note 1: Stresses greater than those listed under "Absolute Maximum Ratings" may cause permanent damage to the device. These are stress ratings only, and functional operation of the device at these or any other conditions beyond those indicated under "Recommended Operating Conditions" is not implied. Exposure to "Absolute Maximum Ratings" for extended periods may affect device reliability.

Recommended Operating Conditions

Parameter	Symbol	Min	Max	Unit
Supply Voltage	V_{IN}		8	V
Operating Junction Temperature	T_J	-40	125	°C



1A LOW DROPOUT LINEAR REGULATOR **AP2218**

Electrical Characteristics

AP2218-3.3V Electrical Characteristics

Operating Conditions: $V_{IN}=4.3V$, $C_{IN}=10\mu F$, $C_{OUT}=10\mu F$, $T_J=25^\circ C$, unless otherwise specified. The **Boldface** applies over $-40^\circ C \leq T_J \leq 125^\circ C$. ($P \leq$ maximum power dissipation.)

Parameter	Symbol	Condition	Min	Typ	Max	Unit	
Output Voltage	V_{OUT}	$I_{OUT}=10mA$	3.27	3.3	3.33	V	
		$10mA \leq I_{OUT} \leq 1A$, $4.3V \leq V_{IN} \leq 6.3V$ (Note 2)	3.23		3.37	V	
Line Regulation	V_{RLINE}	$I_{OUT}=10mA$, $4.3V \leq V_{IN} \leq 8V$		3.3	33	mV	
Load Regulation	V_{RLOAD}	$V_{IN}=4.3V$, $10mA \leq I_{OUT} \leq 1A$		6.6	50	mV	
Output Voltage Temperature Coefficient	$\Delta V_{OUT}/\Delta T$	$I_{OUT}=10mA$		66	330	$\mu V/^\circ C$	
Dropout Voltage (Note 3)	V_{DROP}	$\Delta V_{OUT}=1\%$		70	200	mV	
			$I_{OUT}=100mA$		300	550	mV
Ground Current	I_{GND}	$V_{IN}=4.3V$	$I_{OUT}=750mA$		6	15	mA
			$I_{OUT}=1A$		10		mA
Current Limit	I_{LIMIT}	$V_{OUT}=0V$ (Note 4)	1.5	2.2		A	
Minimum Load Current	$I_{LOAD(MIN)}$			1	5	mA	
Output Noise Voltage (rms)		10Hz to 100KHz, $I_{OUT}=100mA$, $C_{OUT}=10\mu F$		400		μV	
Enable Input							
Enable Input Voltage	V_{EN}	Logic low (off)			0.8	V	
		Logic high (on)	2.25			V	
Enable Input Current	I_{IN}	$V_{EN}=2.25V$	1	15	30 75	μA	
		$V_{EN}=0.8V$			2 4	μA	
Shutdown Output Current	$I_{OUT(SHDN)}$	(Note 5)		10	20	μA	

Note 2: For the details of V_{IN} range, please refer to $(V_{IN}-V_{OUT}) * I_{LOAD} \leq$ maximum power dissipation (Figure 4).

Note 3: Dropout voltage is defined as the input-to-output differential when the output voltage drops to 99% of its nominal value which is measured at $V_{OUT}+1V$ applied to V_{IN} .

Note 4: $V_{IN}=V_{OUT(NOMINAL)}+1V$.

Note 5: $V_{EN} \leq 0.8V$, $V_{IN} \leq 8V$, $V_{OUT}=0V$.



1A LOW DROPOUT LINEAR REGULATOR **AP2218**

Electrical Characteristics (Continued)

AP2218-5.0V Electrical Characteristics

Operating Conditions: $V_{IN}=6V$, $C_{IN}=10\mu F$, $C_{OUT}=10\mu F$, $T_J=25^\circ C$, unless otherwise specified. The **Boldface** applies over $-40^\circ C \leq T_J \leq 125^\circ C$. ($P \leq$ maximum power dissipation.)

Parameter	Symbol	Condition	Min	Typ	Max	Unit	
Output Voltage	V_{OUT}	$I_{OUT}=10mA$	4.95	5.0	5.05	V	
		$10mA \leq I_{OUT} \leq 1A$, $6V \leq V_{IN} \leq 8V$ (Note 2)	4.90		5.10	V	
Line Regulation	V_{RLINE}	$I_{OUT}=10mA$, $6V \leq V_{IN} \leq 8V$		5	50	mV	
Load Regulation	V_{RLOAD}	$V_{IN}=6V$, $10mA \leq I_{OUT} \leq 1A$		10	75	mV	
Output Voltage Temperature Coefficient	$\Delta V_{OUT}/\Delta T$	$I_{OUT}=10mA$		100	500	$\mu V/^\circ C$	
Dropout Voltage (Note 3)	V_{DROP}	$\Delta V_{OUT}=1\%$	$I_{OUT}=100mA$		70	200	mV
			$I_{OUT}=1A$		300	550	mV
Ground Current	I_{GND}	$V_{IN}=6V$	$I_{OUT}=750mA$		6	15	mA
			$I_{OUT}=1A$		10		mA
Current Limit	I_{LIMIT}	$V_{OUT}=0V$ (Note 4)	1.5	2.2		A	
Minimum Load Current	$I_{LOAD(MIN)}$			1	5	mA	
Output Noise Voltage (rms)		10Hz to 100KHz, $I_{OUT}=100mA$, $C_{OUT}=10\mu F$		400		μV	
Enable Input							
Enable Input Voltage	V_{EN}	Logic low (off)			0.8	V	
		Logic high (on)	2.25			V	
Enable Input Current	I_{IN}	$V_{EN}=2.25V$	1	15	30 75	μA	
		$V_{EN}=0.8V$			2 4	μA	
Shutdown Output Current	$I_{OUT(SHDN)}$	(Note 5)		10	20	μA	

Note 2: For the details of V_{IN} range, please refer to $(V_{IN}-V_{OUT}) * I_{LOAD} \leq$ maximum power dissipation (Figure 4).

Note 3: Dropout voltage is defined as the input-to-output differential when the output voltage drops to 99% of its nominal value which is measured at $V_{OUT}+1V$ applied to V_{IN} .

Note 4: $V_{IN}=V_{OUT(NOMINAL)}+1V$.

Note 5: $V_{EN} \leq 0.8V$, $V_{IN} \leq 8V$, $V_{OUT}=0V$.



1A LOW DROPOUT LINEAR REGULATOR

AP2218

Typical Performance Characteristics

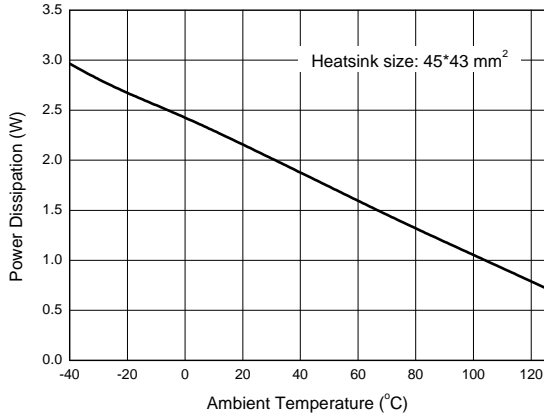

Figure 4. Power Dissipation vs. Ambient Temperature

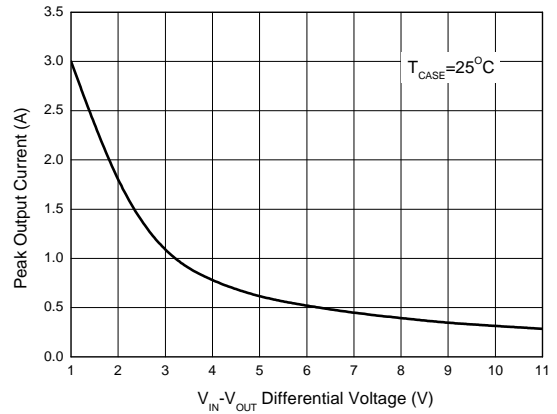

Figure 5. Peak Output Current vs. $V_{IN}-V_{OUT}$ Differential Voltage

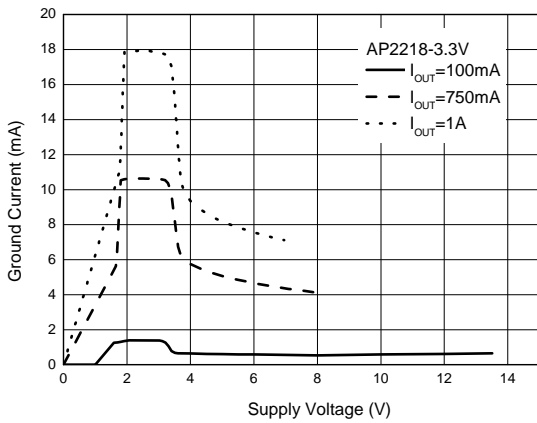

Figure 6. Ground Current vs. Supply Voltage

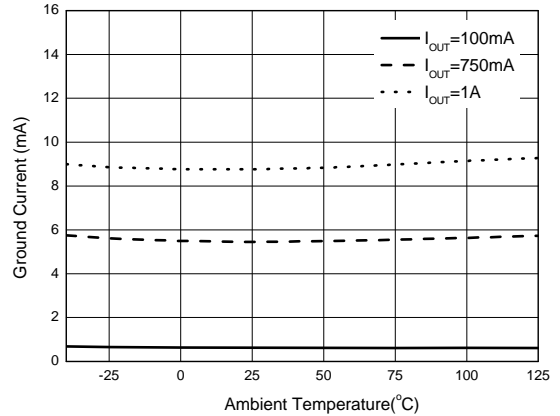

Figure 7. Ground Current vs. Ambient Temperature



1A LOW DROPOUT LINEAR REGULATOR **AP2218**

Typical Performance Characteristics (Continued)

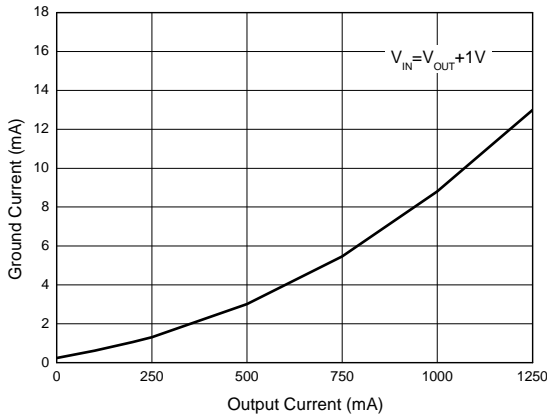

Figure 8. Ground Current vs. Output Current

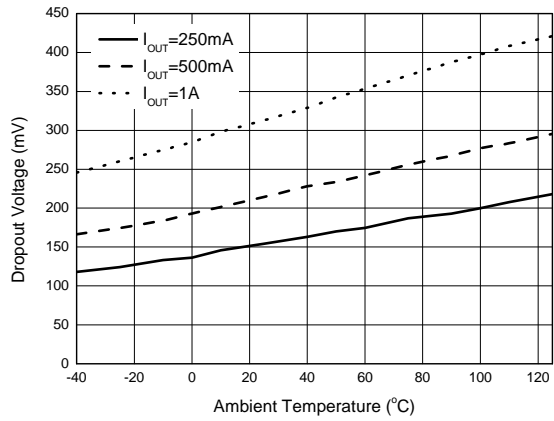

Figure 9. Dropout Voltage vs. Ambient Temperature

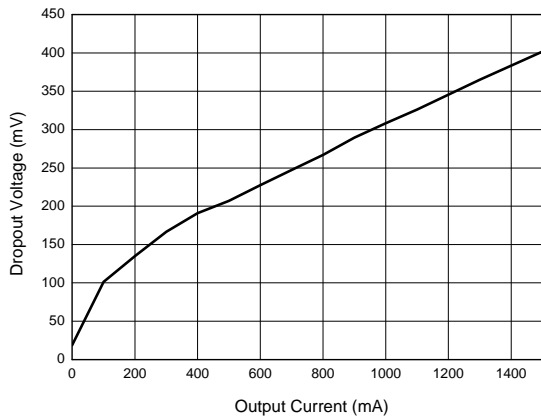

Figure 10. Dropout Voltage vs. Output Current

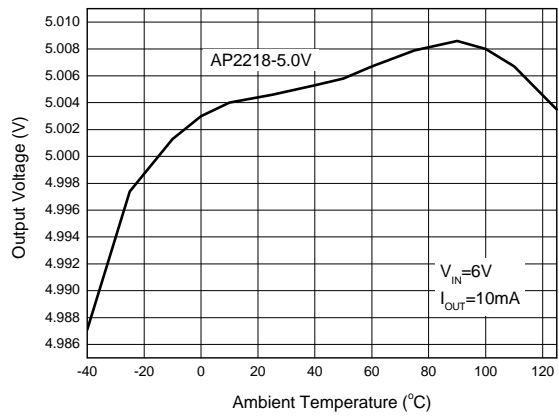

Figure 11. Output Voltage vs. Ambient Temperature



1A LOW DROPOUT LINEAR REGULATOR

AP2218

Typical Performance Characteristics (Continued)

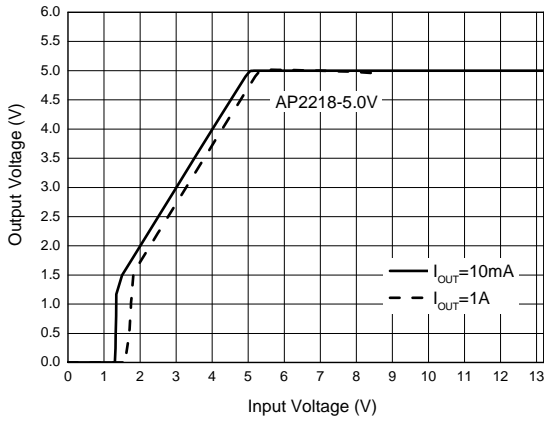

Figure 12. Dropout Characteristics

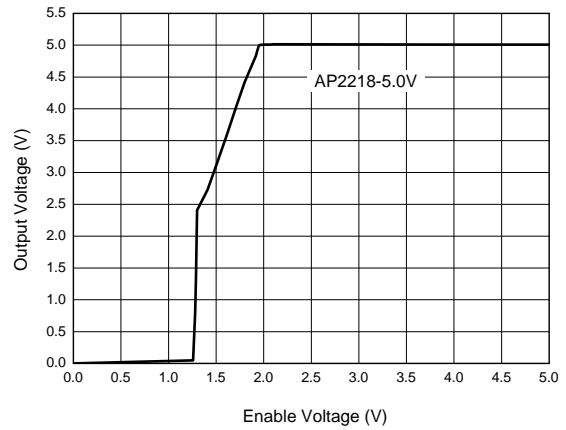

Figure 13. Output Voltage vs. Enable Voltage

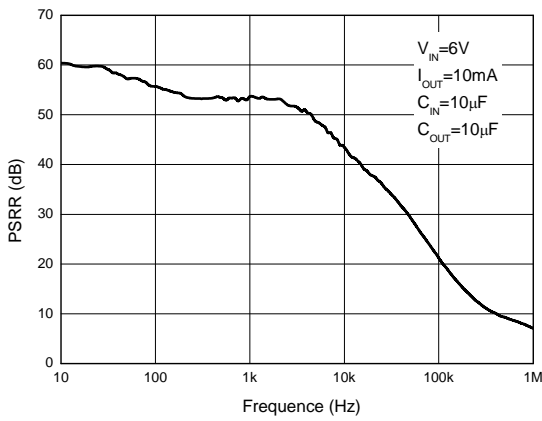

Figure 14. Power Supply Rejection Ratio

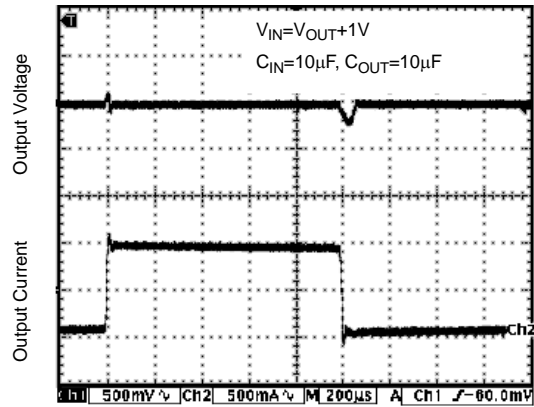

Figure 15. Load Transient



1A LOW DROPOUT LINEAR REGULATOR

AP2218

Typical Performance Characteristics (Continued)

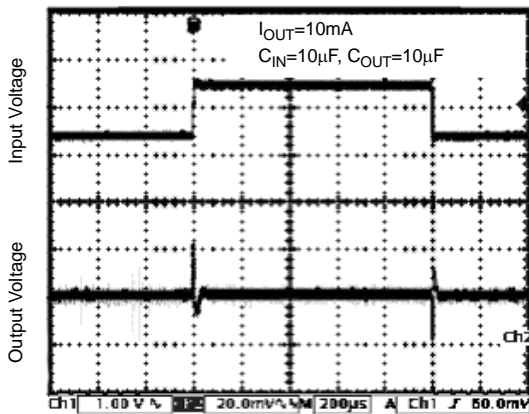

Figure 16. Line Transient



1A LOW DROPOUT LINEAR REGULATOR **AP2218**

Typical Application

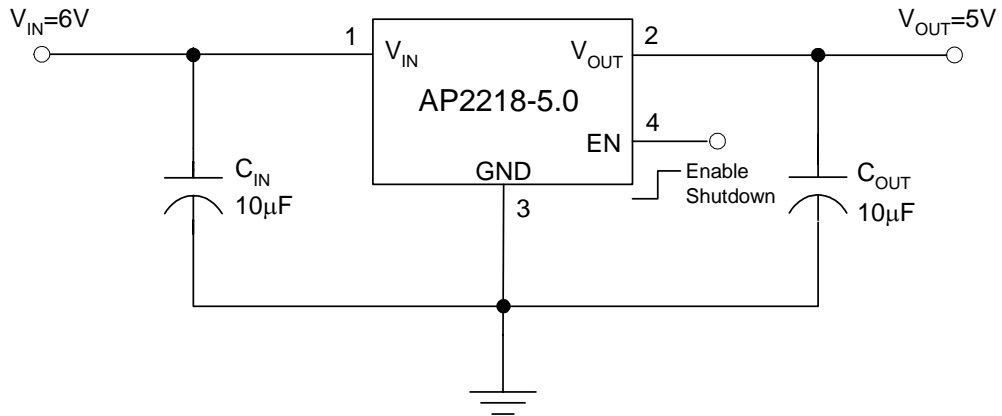

Figure 17. Typical Application of AP2218



1A LOW DROPOUT LINEAR REGULATOR

AP2218

Mechanical Dimensions

TO-220F-4

Unit: mm(inch)

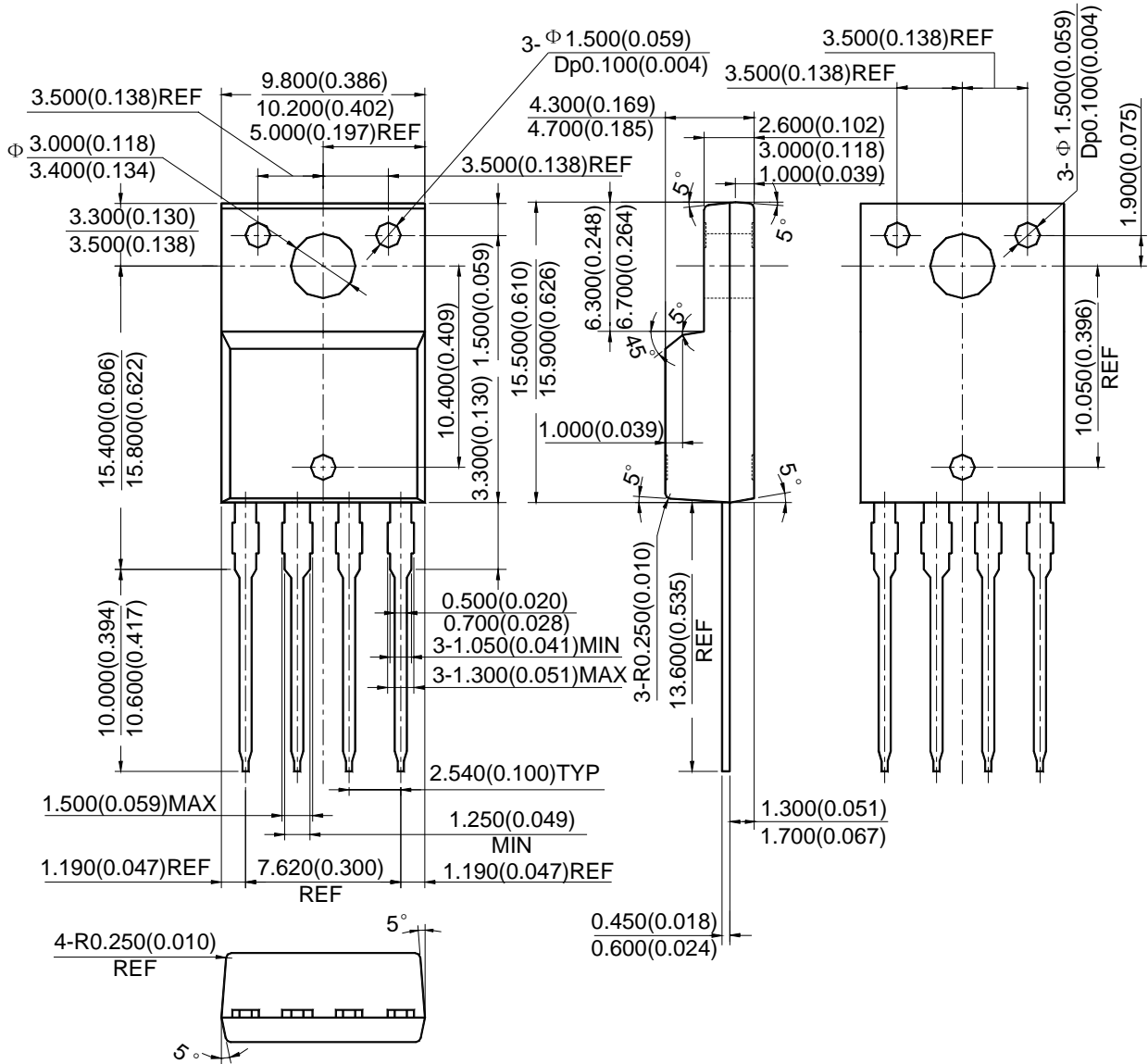



BCD Semiconductor Manufacturing Limited

<http://www.bcdsemi.com>

BCD Semiconductor Corporation

3170 De La Cruz Blvd, Suite # 105 Santa Clara, CA 95054-2411, U.S.A

Tel: +1-408-988 6388, Fax: +1-408-988 6386

Shanghai SIM-BCD Semiconductor Manufacturing Co., Ltd.

800 Yi Shan Road, Shanghai 200233, PRC

Tel: +86-21-6485 1491, Fax: +86-21-5450 0008

Advanced Analog Circuits (Shanghai) Corporation

8F, B Zone, 900 Yi Shan Road, Shanghai 200233, PRC

Tel: +86-21-6495 9539, Fax: +86-21-6485 9673

BCD Semiconductor (Taiwan) Company Limited

4F, 298-1 Rui Guang Road, Nei-Hu District, Taipei, Taiwan

Tel: +886-2-2656-2808, Fax: +886-2-2656-2806

IMPORTANT NOTICE

BCD Semiconductor Manufacturing Limited reserves the right to make changes without further notice to any products or specifications herein. BCD Semiconductor Manufacturing Limited does not assume any responsibility for use of any its products for any particular purpose, nor does BCD Semiconductor Manufacturing Limited assume any liability arising out of the application or use of any its products or circuits. BCD Semiconductor Manufacturing Limited does not convey any license under its patent rights or other rights nor the rights of others.