

### Features

- Up to 88% Max power efficiency
- Wide input voltage range: 2.7V ~ 5.5V
- 1x, 1.5x, and 2x charge-pump modes
- Drive up to 4 white LEDs
- Default maximum current setting: 20mA each channel
- 120mA maximum output current through 4 channels
- Programmable switching frequency, default 1.2MHz
- Up Spread Spectrum Control with 10% frequency deviation
- 1-wire Serial Digital Interface (SDI) or PWM for dimming control
- Soft-start during power-up and mode switching
- Soft-stop during shutdown
- Short-circuit protection
- Over-voltage protection and under-voltage lockout
- Low shutdown current < 1µA
- Industry-leading low profile package
- DFN3030-12: Available in “Green” Molding Compound (No Br, Sb)
- Lead Free Finish / RoHS Compliant (Note 1)

### General Description

The AP3152 is a high efficiency charge-pump white LED driver with 1x, 1.5x, 2x operating modes. The AP3152 operates on power supplies from 2.7v to 5.5v. It drives up to four channels of white LEDs while the intensity of each channel is configured by varying the respective current levels. Each channel can supply up to 30mA current. Up to four channels can be ganged together to provide maximum load current of 120mA.

The Serial Digital Interface (SDI) provides the capability to configure the current for each LED channel. Some other key features, such as Up Spread Spectrum Control, different charge-pump switching frequencies (0.6MHz/1.2MHz/1.8MHz), and PWM dimming control, can also be programmed through the interface.

The AP3152 has a built-in soft-start circuit to minimize the inrush current during power-up and mode switching. Various protections such as short-circuit, over-voltage, under-voltage, and thermal shutdown are integrated to ensure system reliability. The quiescent current of AP3152 during shutdown is less than 1µA.

### Applications

- Mobile Phone
- PDA (Personal Digital Assistant)
- White LED Backlighting
- Camera Flash LED Lighting
- LCD Modules
- Portable Devices

### Ordering Information

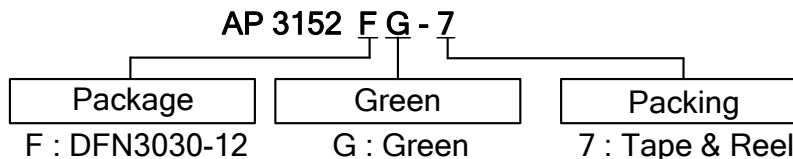

Device	Package Code	Packaging (Note 2)	7" Tape and Reel	
			Quantity	Part Number Suffix
AP3152FG-7	F	DFN3030-12	3000/Tape & Reel	-7

- Notes:
1. EU Directive 2002/95/EC (RoHS). All applicable RoHS exemptions applied. Please visit our website at [http://www.diodes.com/products/lead\\_free.html](http://www.diodes.com/products/lead_free.html).
  2. Pad layout as shown on Diodes Inc. suggested pad layout document AP02001, which can be found on our website at <http://www.diodes.com/datasheets/ap02001.pdf>

**Pin Assignment**

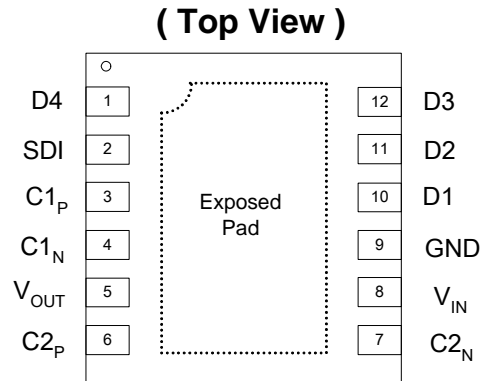

**DFN3030-12**

**Pin Descriptions**

Pin Name	Pin #	Description
D4	1	Current Sink Input #4. Connect to $V_{OUT}$ when un-used.
SDI	2	1-wire Serial Digital Interface Input / PWM input
C1 <sub>P</sub>	3	Positive Terminal of Flying Capacitor. Connect a 1 $\mu$ F capacitor between C1 <sub>P</sub> and C1 <sub>N</sub> .
C1 <sub>N</sub>	4	Negative Terminal of Flying Capacitor.
$V_{OUT}$	5	The charge pump output voltage to drive load circuit. Connect a 1 $\mu$ F capacitor between this pin and ground.
C2 <sub>P</sub>	6	Positive Terminal of Flying Capacitor. Connect a 1 $\mu$ F capacitor between C2 <sub>P</sub> and C2 <sub>N</sub> .
C2 <sub>N</sub>	7	Negative Terminal of Flying Capacitor.
$V_{IN}$	8	Input Power Source. Connect a 1 $\mu$ F capacitor between this pin and ground.
GND	9	Ground.
D1	10	Current Sink Input #1. Connect to $V_{OUT}$ when un-used.
D2	11	Current Sink Input #2. Connect to $V_{OUT}$ when un-used.
D3	12	Current Sink Input #3. Connect to $V_{OUT}$ when un-used.
GND	EP PAD	Exposed Pad (bottom). Connect to ground underneath the package.

**Block Diagram**

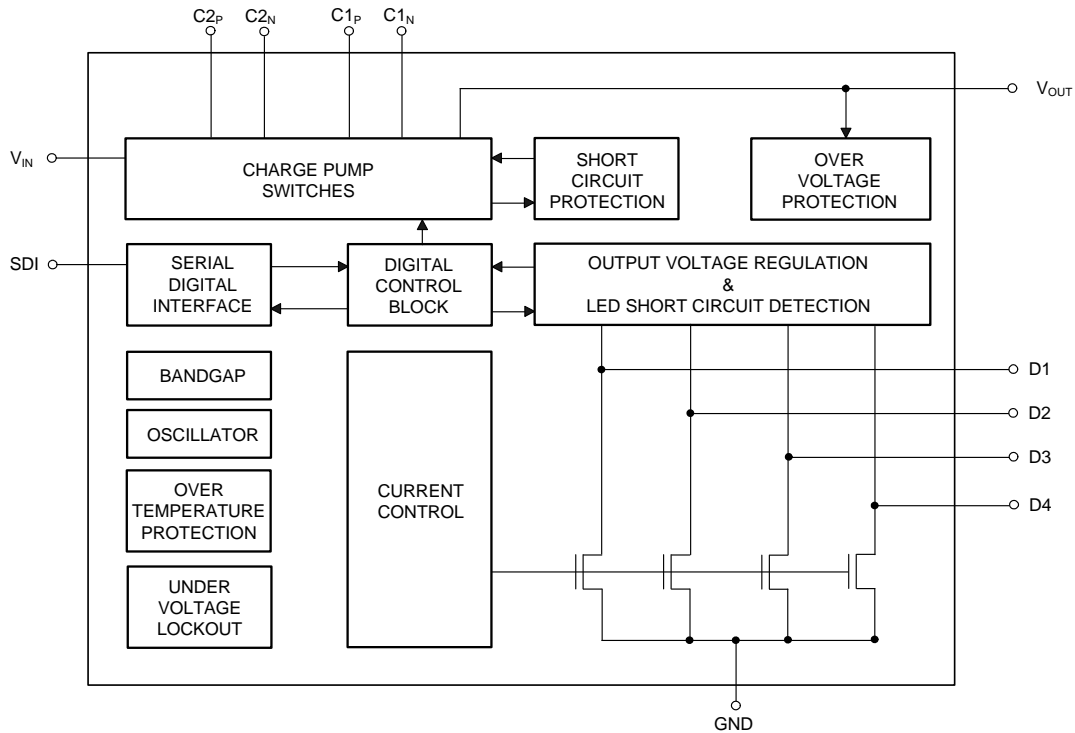

**Typical Application Circuit**

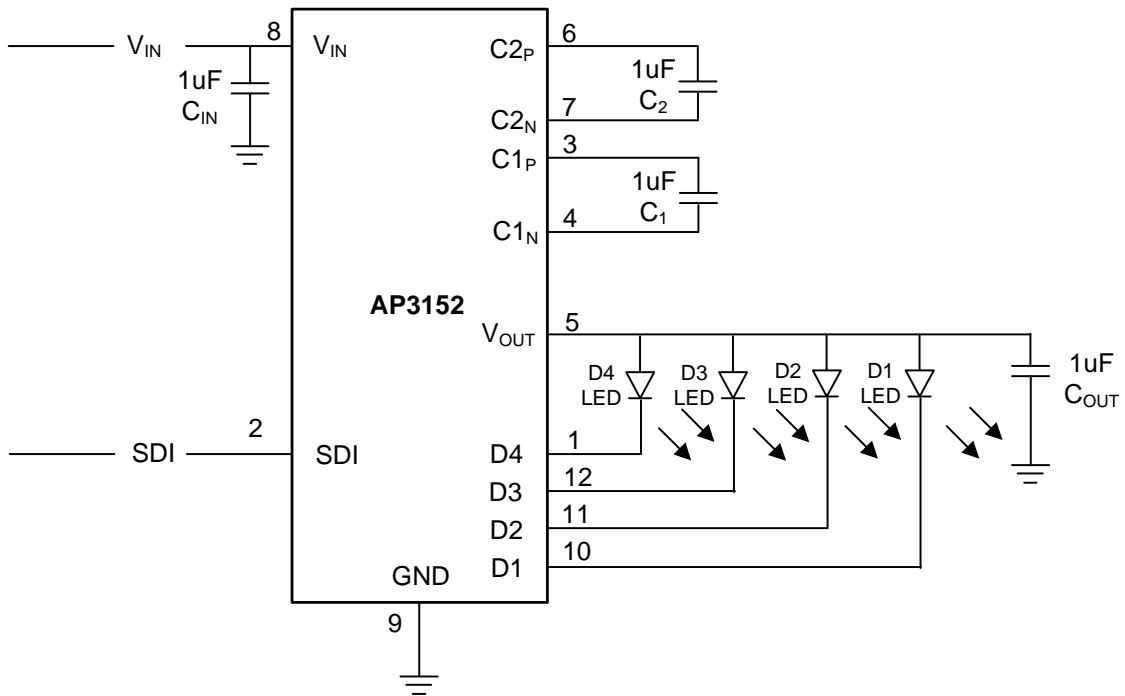

## Absolute Maximum Ratings

Symbol	Description	Value	Units
ESD HBM	Human Body Model ESD Protection	2	KV
ESD MM	Machine Model ESD Protection	200	V
$V_{IN}$	Input Voltage	-0.3 to 6	V
VSDI	SDI to GND Voltage	-0.3 to $V_{IN} + 0.3$	V
$I_{OUT}$	Maximum DC Output Current	150	mA
$P_D$	Maximum Power Dissipation	0.85	W
$T_j$	Operating Junction Temperature Range	-40 to 150	°C

Notes: 3. Exceeding Absolute Maximum Ratings will cause permanent damage to the device.

## Recommended Operating Conditions

Symbol	Parameter	Min	Max	Units
$V_{IN}$	Input Voltage	2.7	5.5	V
$T_A$	Operating Ambient Temperature	-40	85	°C

**Electrical Characteristics**
 $C_{IN} = C_{OUT} = C1 = C2 = 1.0\mu F$ ;  $T_A = 25^\circ C$ ,  $V_{IN} = 3.5V$ . Unless otherwise stated.

Symbol	Description	Conditions	Min	Typ.	Max	Units
$I_Q$	Quiescent Current	1X Mode Fosc=1.2MHz, SDI=HIGH, no load		1.2		mA
$I_{SHDN}$	Shutdown Current	SDI = 0	-1		1	$\mu A$
$I_{DX}$	$I_{SINK}$ Current Accuracy (Note 4)	$I_{SINK} = 20mA$	-10		10	%
$I_{D-Match}$	Current Matching (Note 5)	$V_F: D1=D2=D3=D4$ $I_D = 2, 20mA$			5	%
$T_{SS}$	Soft-start Time			1		ms
$F_{CLK}$	Switching Clock Frequency			0.6/1.2/1.8		MHz
$F_{SSP}$	Spread Spectrum	Enabled		+10		%
$V_{SDI(L)}$	SDI Threshold Low	$V_{IN} = 2.7V$ to $5.5V$			0.4	V
$V_{SDI(H)}$	SDI Threshold High	$V_{IN} = 2.7V$ to $5.5V$	1.6			V
$T_{SLO}$	SDI Low Time		0.05		50	$\mu s$
$T_{SHI}$	SDI High Time		0.05		50	$\mu s$
$f_{PWM}$	PWM Frequency (Range 1)		0.2		1.5	KHz
	PWM Frequency (Range 2)		20		30	KHz
$T_{PWM}$	PWM Signal Period		$1/f_{PWM-Max}$		$1/f_{PWM-Min}$	$\mu s$
$T_{PLO}$	PWM Signal Low (LED off)		1		$T_{PWM} - 1$	$\mu s$
$T_{PHI}$	PWM Signal High (LED on)		1		$T_{PWM} - 1$	$\mu s$
$T_{OFF}$	Chip Disable (held low)	PWM		65	100	ms
		No PWM		512	800	$\mu s$
$T_{SEP}$	Interval between SDI sequences (held high)	PWM		65	100	ms
		No PWM		512	800	$\mu s$
$I_{SDI}$	SDI Input Leakage		-1		1	$\mu A$
$I_{SCP}$	$V_{OUT}$ Short to GND hold Current			500		mA
$T_{SD}$	Thermal Shutdown Temperature			+150		$^\circ C$
$\theta_{JA}$	Thermal Resistance1 – Junction to Ambient	DFN3030-12 (Note 6)		160		$^\circ C/W$
$\theta_{JC}$	Maximum Thermal Resistance1 – Junction to Case	DFN3030-12 (Note 6)		21		$^\circ C/W$

- Notes: 4. Determined by the average current levels of all active channels.  
5. Defined as the deviation of any sink current from the average of all active current channels.  
6. Device mounted on FR-4 substrate PC board, 2oz copper, with minimum recommended pad layout.

**Typical Performance Characteristics**

**Efficiency vs. Supply Voltage**

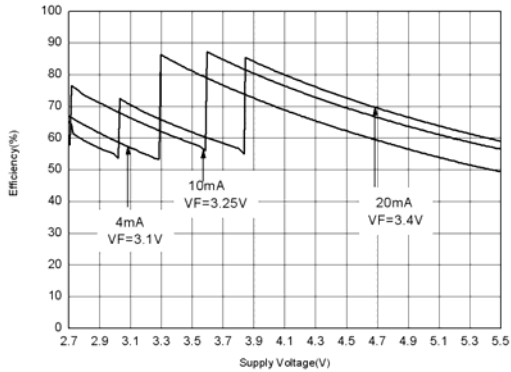

**Turn-On to 1X Mode**  
( $V_{IN} = 4.2V$ ; 20mA Load)

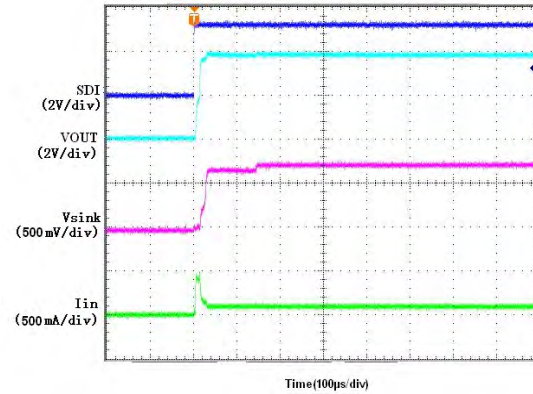

**Turn-On from 1.5X Mode**  
( $V_{IN} = 3.5V$ ; 20mA Load)

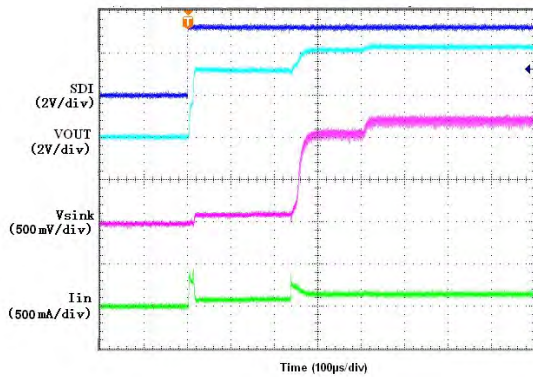

**Turn-On to 2X Mode**  
( $V_{IN} = 2.7V$ ; 20mA Load)

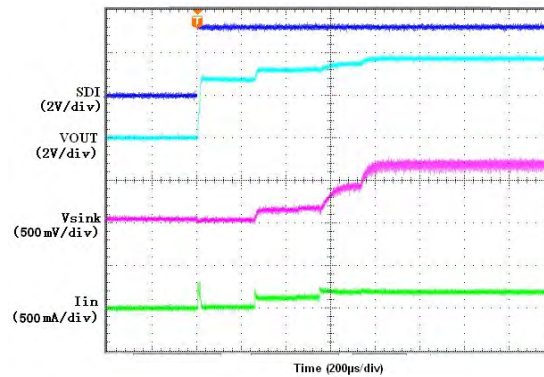

**Turn-Off from 1.5X Mode**  
( $V_{IN} = 3.5V$ ; 20mA Load)

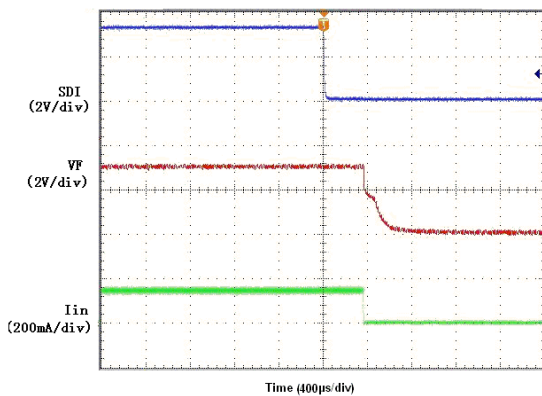

**Current Matching vs. Temperature**

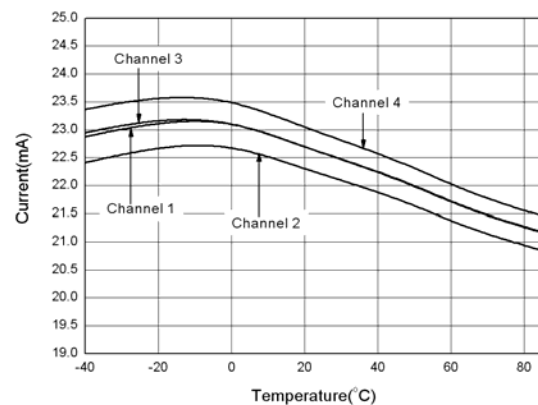

**Typical Performance Characteristics (Continued)**

**Load Characteristics**  
( $V_{IN} = 3.5V$ ; 1.5X Mode; 14mA Load)

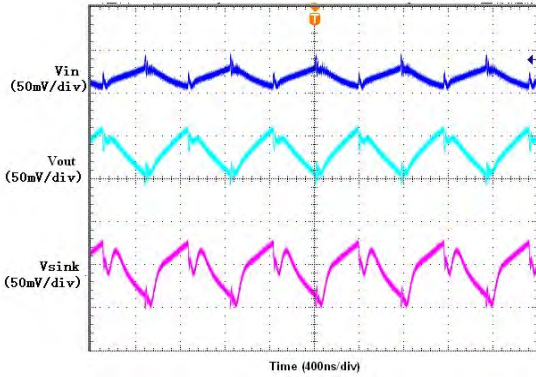

**Load Characteristics**  
( $V_{IN} = 2.7V$ ; 2X Mode; 14mA Load)

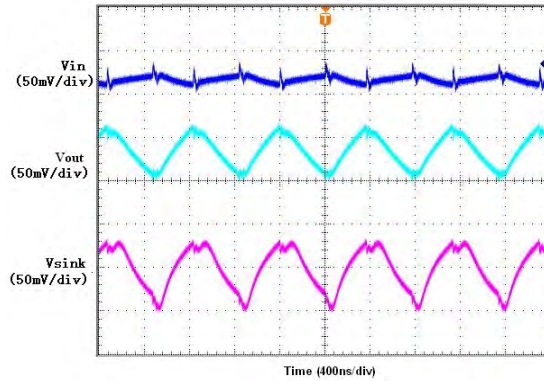

**Load Characteristics**  
( $V_{IN} = 3.5V$ ; 1.5X Mode; 20mA Load)

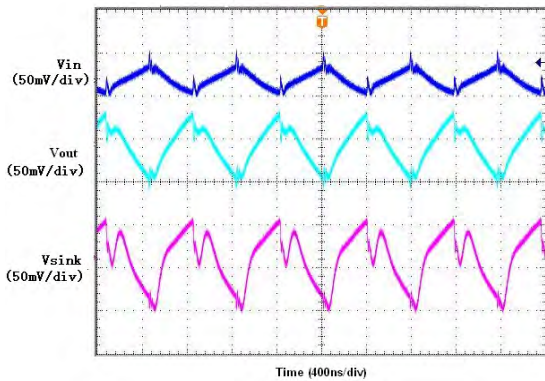

**Load Characteristics**  
( $V_{IN} = 2.7V$ ; 2X Mode; 20mA Load)

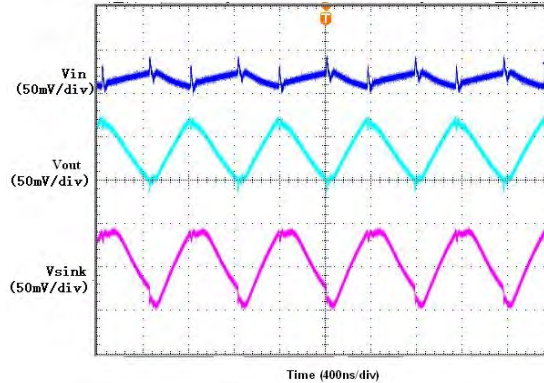

**Load Characteristics**  
( $V_{IN} = 3.5V$ ; 1.5X Mode; 30mA Load)

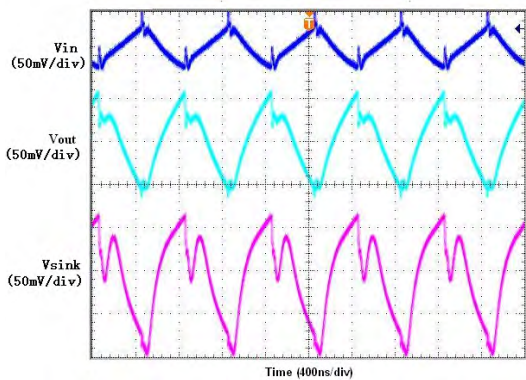

**Load Characteristics**  
( $V_{IN} = 3.1V$ ; 2X Mode; 30mA Load)

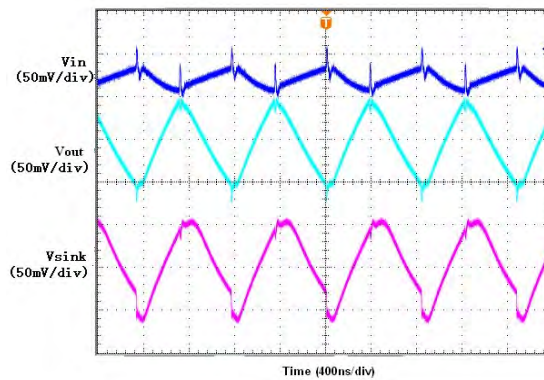

**Typical Performance Characteristics (Continued)**

**Enable Threshold High vs. Input Voltage**

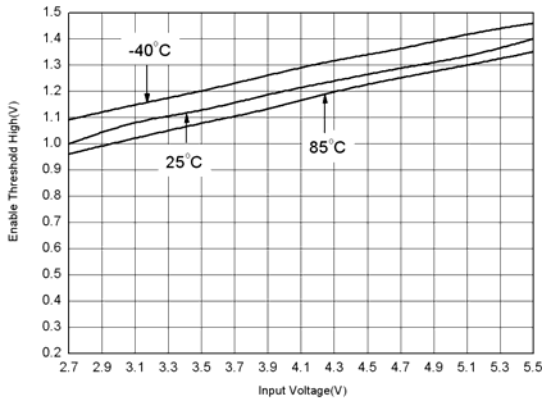

**Enable Threshold Low vs. Input Voltage**

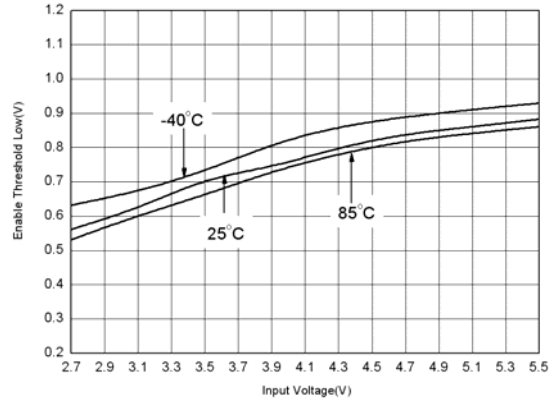

**PWM Dimming Operation**  
( $V_{IN} = 3.5V$ ; 20mA Load; Duty=1:1;  $f=1KHz$ )

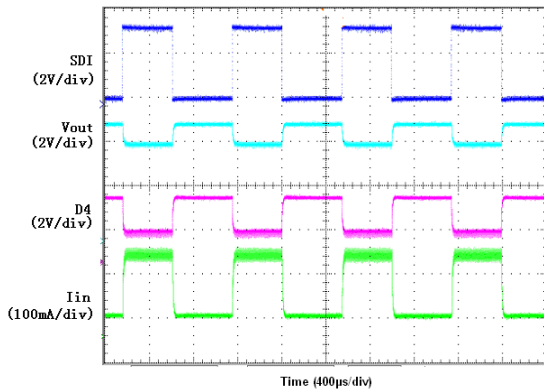

**PWM Dimming Operation**  
( $V_{IN} = 3.5V$ ; 20mA Load; Duty=11:1;  $f=1KHz$ )

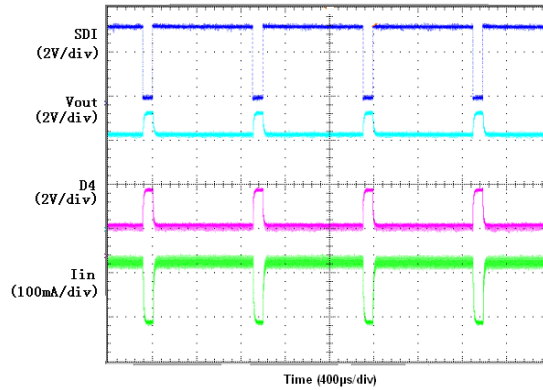

**PWM Dimming Operation**  
( $V_{IN} = 3.5V$ ; 20mA Load; Duty=1:11;  $f=1KHz$ )

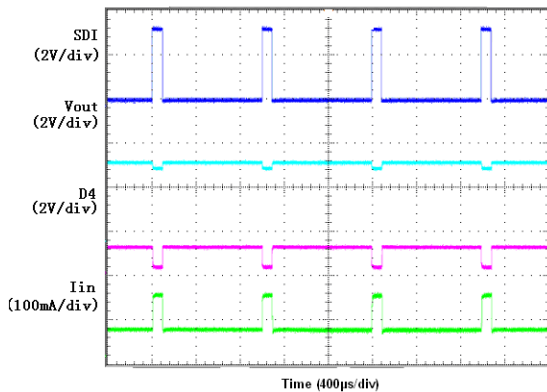



### Functional Description

#### General Functional Description

The AP3152 is designed for white LED applications. An internal comparator circuit compares the voltage at each constant current sink input against a reference voltage. To ensure maximum power efficiency, the most appropriate switching mode (x1, x1.5, x2) is automatically selected.

In applications, only four external components are required: two 1µF ceramic flying capacitors (C<sub>1</sub> and C<sub>2</sub>), one 1µF ceramic capacitor each for input and output (C<sub>IN</sub>, C<sub>OUT</sub>).

AP3152 drives up to four white LEDs with a maximum current of 30mA each. A total of 120mA is provided to the four channels. Through SDI, the current into each channel can be configured in accordance to specific protocol and pre-defined values.

Maximum output current can be set to one of the four possible scales: 2mA, 14mA, 20mA, 30mA. Among these, the '2mA' setting is called "low current mode". This would be useful for applications which require very low operating current, e.g. transmissive LCD panels.

For each maximum output current scale, there are 16 current level settings separated from one another by approximately 1dB. While level-16 corresponds to maximum current output, level-1 corresponds to zero output current. As the current level varies logarithmically, intensity of the LED changes in a linear fashion.

The current level at the individual channels is configured via SDI which supports data rate up to 10MHz. It allows the main controller in the system to be offloaded to perform more mission-critical functions.

#### Serial Digital Interface

SDI is a general purpose 1-wire digital interface designed to transport digital controls for power management ICs such as AP3152. The current levels of the four channels can be configured either together or individually. Up to 16 current levels are allowed. A generic system controller can easily support the SDI protocol via bit-banging over its general purpose I/Os.

The SDI protocol is simple yet flexible enough to accommodate different switching clock frequencies. Any sequence of negative-edged pulses of 63 or less (see table 1), separated by T<sub>SEP</sub> at the SDI pin is interpreted by AP3152 as a channel configuration event. In the future, the number of pulses can be extended to support additional commands.

In addition to the SDI protocol, dimming control can also be achieved by presenting a timing-specific PWM signaling at the SDI pin.

Number of Falling Edges	Command Description
1	Current level step up (1 up to level 16)
2	Current level step down (16 down to level 1)
3	Current level set to 16 (maximum current level)
4	Current level set to 1 (minimum current level)
5	All 4 Channels in dimming control

6	CH2, CH3 and CH4 in dimming control
7	CH1 and CH2 in dimming control
8	CH3 and CH4 in dimming control
9	CH1 in dimming control
10	CH2 in dimming control
11	CH3 in dimming control
12	CH4 in dimming control
13	Low-Current Mode (Maximum Current set to 2mA)
14	Maximum Current set to 14mA (All channels)
15	Maximum Current set to 20mA (All channels)
16	Maximum Current set to 30mA (All channels)
17	10% Up Spread Spectrum Control Enable/Disable
18	Switching Frequency set to 0.6Mhz
19	Switching Frequency set to 1.2Mhz
20	Switching Frequency set to 1.8Mhz
21-62	Reserved
63	PWM Dimming Control Enable/Disable

#### Dimming Control Current Level Setting

AP3152 supports four maximum output current scales including 30mA, 20mA, 14mA, and 2mA low-current scales. For each maximum current scale, there are 16 current level settings separated from one another by approximately 1dB (see table 2). By default, maximum current scale is set to 20mA and dimming control current level is set to maximum (level 16).

Through SDI, certain channels or all four channels can be selected, and dimming control level for these channels can be set to maximum (level 16), minimum (level 1), up from minimum to maximum or down from maximum to minimum (see table 1).

Dimming Control Current Levels	I <sub>out</sub> (20mA)	I <sub>out</sub> (30mA)	I <sub>out</sub> (14mA)	Low-Current (2mA)
16	20.0	30.0	14.0	2.0
15	17.8	26.7	12.5	1.78
14	15.9	23.8	11.1	1.59
13	14.3	21.4	10.0	1.43
12	12.7	19.0	8.9	1.27
11	11.1	16.7	7.8	1.11
10	10.2	15.2	7.1	1.02
9	8.9	13.3	6.2	0.89
8	7.9	11.9	5.6	0.79
7	7.0	10.5	4.9	0.70
6	6.3	9.5	4.4	0.63
5	5.7	8.6	4.0	0.57
4	5.1	7.6	3.5	0.51
3	4.4	6.7	3.1	0.44
2	4.1	6.2	2.9	0.41
1	0.05	0.05	0.05	0.05

Table 2: Dimming Control Current Level

---

**Functional Description (Continued)**

---

**Disabled Current Sinks**

Unused current channels must be disabled by connecting the sinks to  $V_{OUT}$  with only a small sense current flowing through the disabled channel.

**Soft-Start and Soft-Stop**

Soft-start and Soft-stop function are incorporated to prevent excessive inrush current during power-up, mode switching, power-down, transition out of stand-by mode.

**Short-Circuit Protection**

Short-circuit protection function is incorporated to prevent excessive load current when either flying cap terminals or output pin electrically tied to a very low voltage or ground.

**Over-Voltage Protection**

Over-voltage protection function is incorporated to limit the output voltage under a safe value to avoid on-chip device breakdown.

**Under-Voltage Lockout**

Under-voltage lockout feature disables the device when the input voltage drops below UVLO threshold.

**Thermal Shutdown**

When the die temperature exceeds the thermal limit, the device will be disabled and enter stand-by mode. The operation will be resumed whenever the die cools off sufficiently.

**Switching Frequency**

By default, AP3152 is working at 1.2Mhz switching frequency. It can also work at 0.6MHz or 1.8MHz switching frequency set through SDI. User can choose the appropriate switching frequency with consideration of noise immunity, input/output voltage ripple requirement, and capacitor selection etc.

**Up Spread Spectrum Control**

When this feature is enabled through SDI, the switching frequency periodically varies between 100% and 110% of nominal frequency. It flattens the peak energy on nominal frequency over a range of frequency band so that EMI effect is significantly reduced.

**PWM Dimming Control**

The AP3152 provides flexible dimming control with either 16-level SDI protocol control or PWM dimming control through SDI pin. When PWM dimming control is enabled, the sink current is adjusted by the duty cycle of the signal applied on SDI pin.

---

**Serial Digital Interface Continued**

---

**SDI Command Timing**

For an SDI command to be successfully received by the AP3152, all SDI timing specifications should be satisfied. When no command is being sent the SDI pin should be held high. If the SDI pin goes low and stays low for a time length of between  $TSLO(min)$  and  $TSLO(max)$  and then goes high and stays high for between  $TSHI(min)$  and  $TSHI(max)$ , one falling edge is registered by the AP3152. The total number of falling edges registered before the SDI pin is held high for longer than the maximum separation time  $TSEP(max)$  identifies the command that has been received by the AP3152. The next series of falling edges before another separation time  $TSEP$  represents the next command. In other words, the AP3152 counts the number of consecutive falling edges on the SDI pin and a different number represents a different command.

Each command is executed after it is successfully received. If at any time the SDI pin is held low for longer than the maximum chip disable time  $TOFF(max)$ , the AP3152 gets disabled and enters the shutdown mode. Setting the SDI pin high again will re-enable the AP3152 and bring it out of the shutdown mode. Exiting from the shutdown mode, the AP3152 will retain all latest configuration settings and return to the same state as before it was disabled.

The AP3152 enters the SDI mode by default when it is first powered up. The first SDI command 63 (63 falling edges) will put the AP3152 into the PWM mode, where a high level on the SDI pin turns the LEDs on, a low level turns the LEDs off and the duty cycle determines the average LED brightness. The next SDI command 63 will put the AP3152 back into the SDI mode. It should be pointed out that the PWM mode is for dimming control only and configuration settings have to be done in the SDI mode.

**Channel Configuration Example**

The following timing diagram is a dimming control example. In this example, the first command (command 10) selects Channel 2 as the configuration target and the second command (command 2) sets the Channel 2 current level to one step lower while the other channels remain unchanged.

**Serial Digital Interface Continued (Continued)**

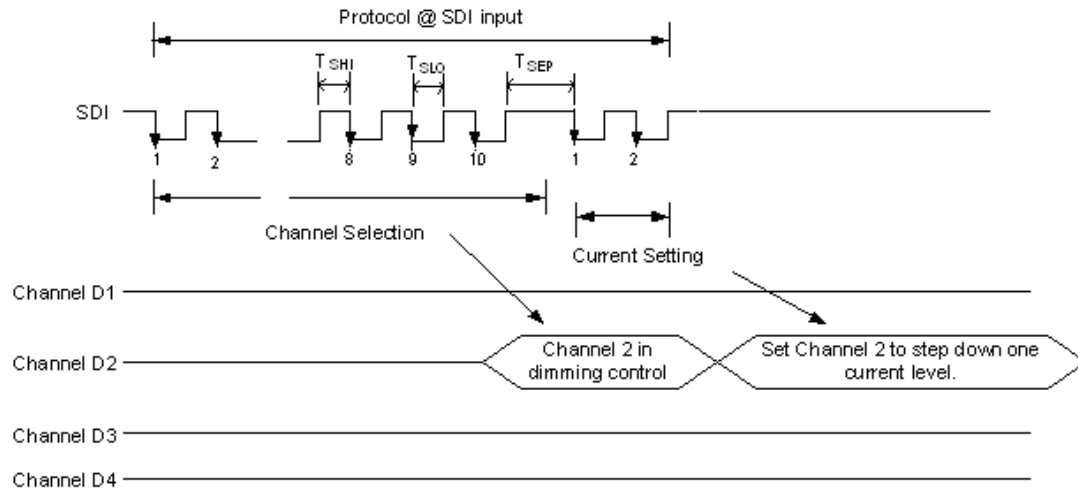

**Marking Information**

(1) DFN3030-12

( Top View )

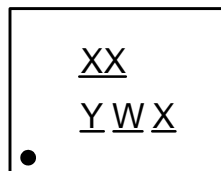

XX : Identification code  
Y : Year 0~9  
W : Week : A~Z : 1~26 week;  
a~z : 27~52 week; z represents  
52 and 53 week  
X : A~Z : Green

Part Number	Package	Identification Code
AP3152F	DFN3030-12	FH

**Package Information** (All Dimensions in mm)

(1) Package type: DFN3030-12

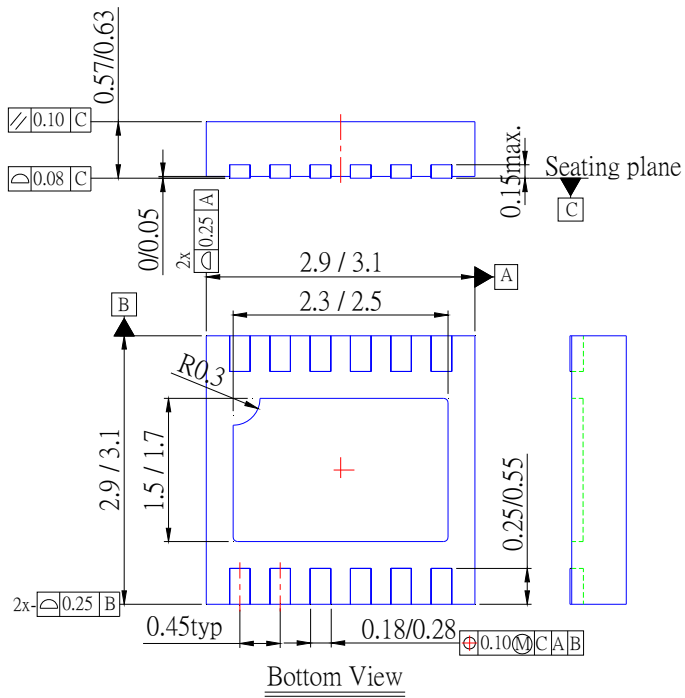

---

## Taping Orientation

---

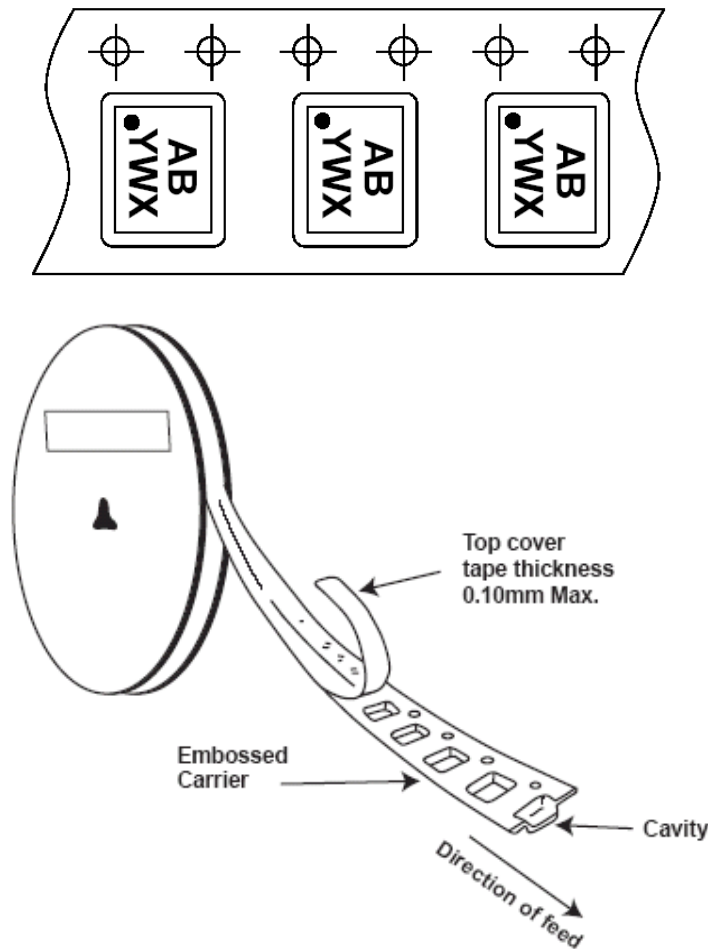

Notes: 7. The taping orientation of the other package type can be found on our website at <http://www.diodes.com/datasheets/ap02007.pdf>

### IMPORTANT NOTICE

Diodes Incorporated and its subsidiaries reserve the right to make modifications, enhancements, improvements, corrections or other changes without further notice to any product herein. Diodes Incorporated does not assume any liability arising out of the application or use of any product described herein; neither does it convey any license under its patent rights, nor the rights of others. The user of products in such applications shall assume all risks of such use and will agree to hold Diodes Incorporated and all the companies whose products are represented on our website, harmless against all damages.

### LIFE SUPPORT

Diodes Incorporated products are not authorized for use as critical components in life support devices or systems without the expressed written approval of the President of Diodes Incorporated.