



Product Features

- 2110 – 2170 MHz
- 30 dB Gain
- +36 dBm P1dB
- -55 dBc ACLR
@ 25 dBm wCDMA linear power
- +12 V Single Supply
- Power Down Mode
- Bias Current Adjustable
- RoHS-compliant flange-mount pkg

Applications

- Final stage amplifiers for repeaters
- Optimized for driver amplifier PA mobile infrastructure

Product Description

The AP502 is a high dynamic range power amplifier in a RoHS-compliant flange-mount package. The multi-stage amplifier module has 30 dB gain, while being able to achieve high performance for PCS-band applications with +36 dBm of compressed 1dB power. The module has been internally optimized for driver applications provide -55 dBc ACLR at 25 for wCDMA applications. The module can be biased down for current when higher efficiency is required.

The AP502 uses a high reliability InGaP/GaAs HBT process technology and does not require any external matching components. The module operates off a +12V supply and does not requiring any negative biasing voltages; an internal active bias allows the amplifier to maintain high linearity over temperature. It has the added feature of a +5V power down control pin. A low-cost metal housing allows the device to have a low thermal resistance to ensure long lifetimes. All devices are 100% RF and DC tested.

The AP502 is targeted for use as a driver or final stage amplifier in wireless infrastructure where high linearity and high power is required. This combination makes the device an excellent candidate for next generation multi-carrier 3G base stations.

Functional Diagram

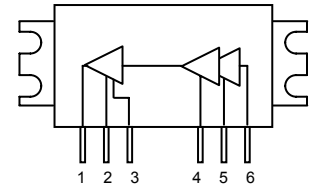

Top View

Pin No.	Function
1	RF Output
2 / 4	Vcc
3 / 5	Vpd
6	RF Input
Case	Ground

Specifications

25 °C, V_{cc}=12V, V_{pd}=5V, I_{cq}=820mA, R7=0Ω, 50Ω unmatched fixture

Parameter	Units	Min	Typ	Max
Operational Bandwidth	MHz	2110 – 2170		
Test Frequency	MHz	2140		
Power Gain	dB	28.5	30	34.5
wCDMA ACLR1 @ 25dBm ⁽¹⁾	dBc		-55	-50
wCDMA ACLR2 @ 25dBm ⁽²⁾			-68	-53
Input Return Loss	dB	11		
Output Return Loss	dB	5.3		
Output P1dB	dBm	+36		
Output IP3	dBm	+52		
Operating Current @ 25 dBm	mA	790	840	940
Quiescent Current, I _{cq}	mA	780	820	920
Device Voltage, V _{cc}	V	+12		
Device Voltage, V _{pd} ⁽²⁾	V	+5		
Load Stability	VSWR	10:1		

1. 3GPP wCDMA signal modulation, Test model 1+32 DPCH, 3.84 MHz BW, ±5 MHz offset.
 2. 3GPP wCDMA signal modulation, Test model 1+32 DPCH, 3.84 MHz BW, ±10 MHz offset.
 3. Pull-down voltage: 0V = "OFF", 5V="ON"

Typical Performance⁽⁴⁾

Parameter	Units	Config1	Config2
Operating Current @ 25 dBm	mA	840	420
Quiescent Current, I _{cq}	mA	820	250
Device Voltage, V _{cc}	V	+12	+12
R7 value	Ω	0	730
Test Frequency	MHz	2140	2140
Power Gain	dB	30	27.7
wCDMA ACLR1 @ 25dBm ⁽²⁾	dBc	-55	-47.5
Input Return Loss	dB	11	10
Output Return Loss	dB	5.3	7
Output P1dB	dBm	+36	+36
Output IP3	dBm	+52	+50

4. Configuration 1 has the module biased in Class AB and is detailed on page 2 of the datasheet. Performance is shown at 25 °C, V_{cc}=12V, V_{pd}=5V, I_{cq}=820mA, R7=0Ω, 50Ω unmatched fixture. Configuration 2 has the module biased in near Class B and is detailed on page 3 of the datasheet. Performance is shown at 25 °C, V_{cc}=12V, V_{pd}=5V, I_{cq}=250mA, R7=730Ω, 50Ω tuned fixture.

Absolute Maximum Rating

Parameter	Rating
Operating Case Temperature	-40 to +85 °C
Storage Temperature	-55 to +150 °C
RF Input Power (continuous) with output terminated in 50 Ω	+15 dBm

Operation of this device above any of these parameters may cause permanent damage.

Ordering Information

Part No.	Description
AP502	UMTS-band 4W HBT Amplifier Module
AP502-PCB	Fully-Assembled Evaluation Board (Class AB configuration, I _{cq} =820mA)

Specifications and information are subject to change without notice



Performance Graphs – Class AB Configuration (AP502-PCB)

The AP502-PCB and AP502 module is configured for Class AB by default. The resistor – R7 – which sets the current draw for the amplifier is set at 0 Ω in this configuration. Increasing that value will decrease the quiescent and operating current of the amplifier module, as described on the next page.

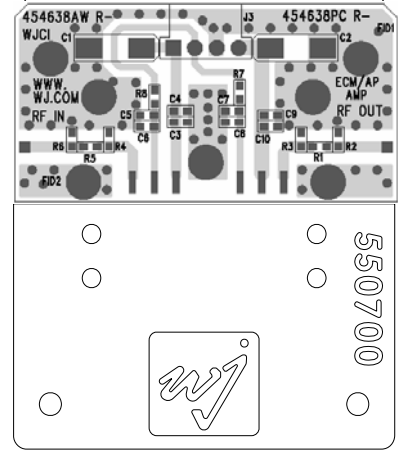
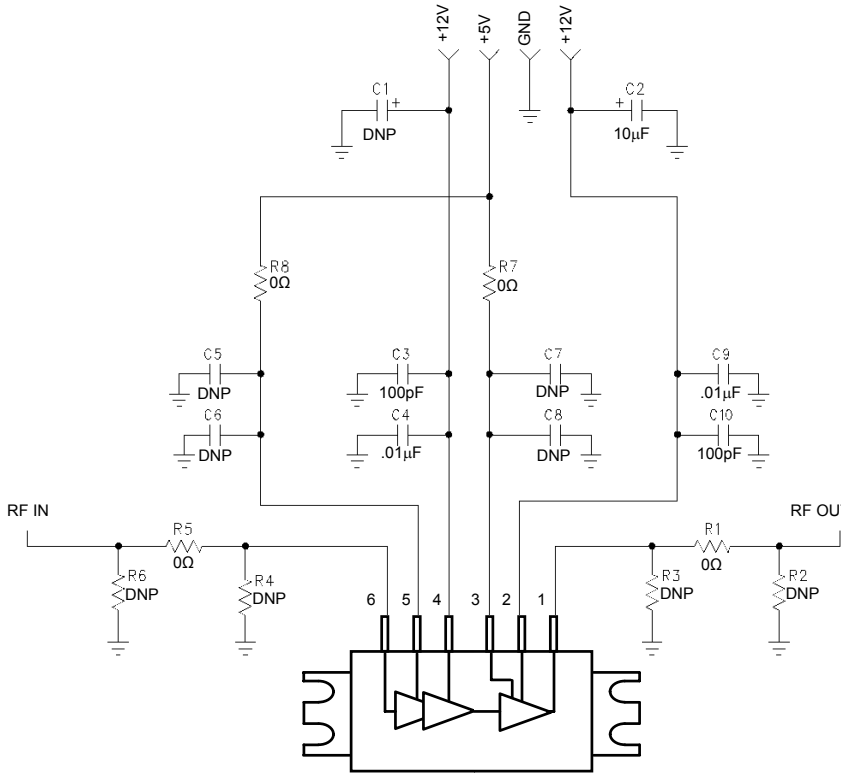

Notes:

- Please note that for reliable operation, the evaluation board will have to be mounted to a much larger heat sink during operation and in laboratory environments to dissipate the power consumed by the device. The use of a convection fan is also recommended in laboratory environments. Details of the mounting holes used in the WJ heatsink are given on the last page of this datasheet.
- The area around the module underneath the PCB should not contain any soldermask in order to maintain good RF grounding.
- For proper and safe operation in the laboratory, the power-on sequencing should be followed:
 - Connect RF In and Out
 - Connect the voltages and ground pins as shown in the circuit.
 - Apply the RF signal
 - Power down with the reverse sequence

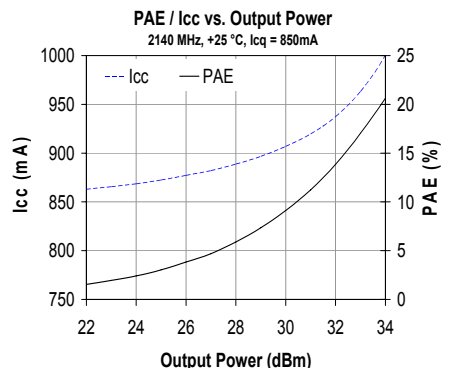
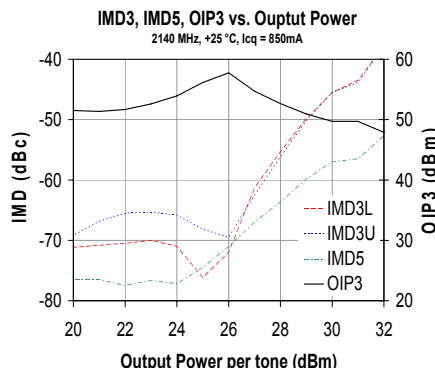
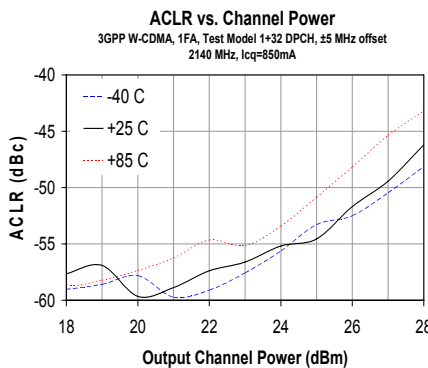
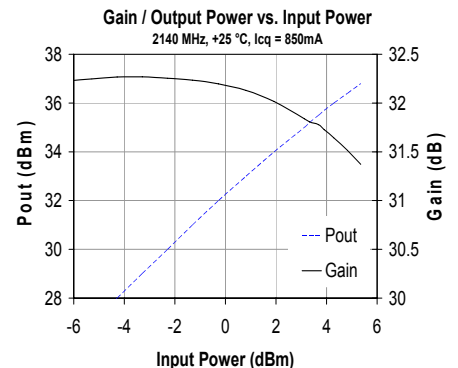
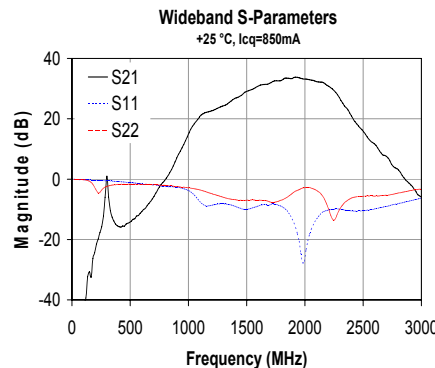
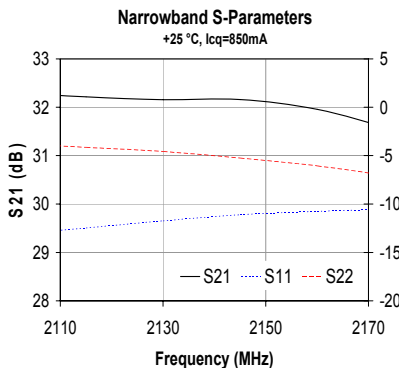

Specifications and information are subject to change without notice



Performance Graphs – Class B Configuration

The AP502 can be adjusted to operate at lower current biasing levels by modifying the R7 resistor for improved efficiency performance. The configuration shown on this page has the AP502 operating with $I_{cq} = 250 \text{ mA}$ ($I_{cc} = 400 \text{ mA}$ @ 27 dBm). Output L-C matching components have been added externally on the circuit to optimize the amplifier for ACPR performance at this biasing configuration.

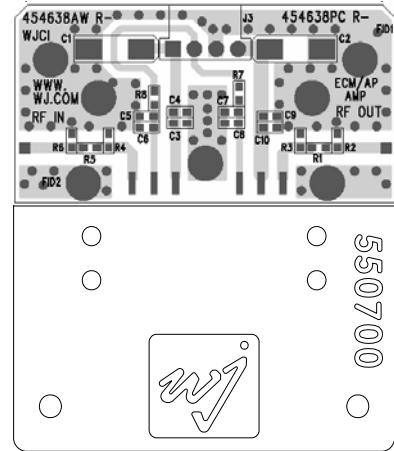
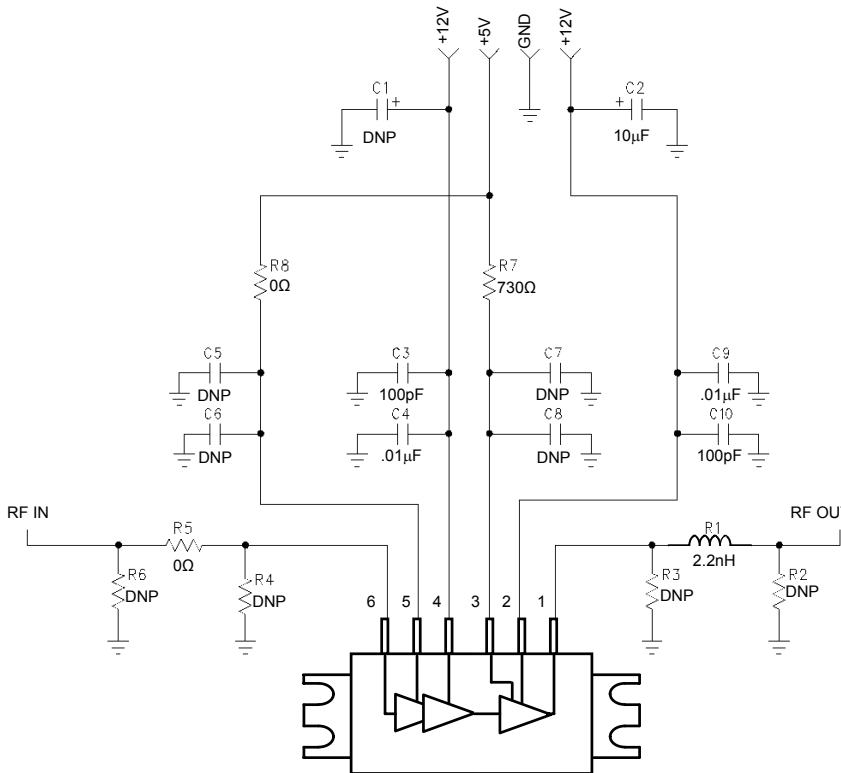

Notes:

- Please note that for reliable operation, the evaluation board will have to be mounted to a much larger heat sink during operation and in laboratory environments to dissipate the power consumed by the device. The use of a convection fan is also recommended in laboratory environments. Details of the mounting holes used in the WJ heatsink are given on the last page of this datasheet.
- The area around the module underneath the PCB should not contain any soldermask in order to maintain good RF grounding.
- For proper and safe operation in the laboratory, the power-on sequencing should be followed:
 - Connect RF In and Out
 - Connect the voltages and ground pins as shown in the circuit.
 - Apply the RF signal
 - Power down with the reverse sequence

Narrowband S-Parameters

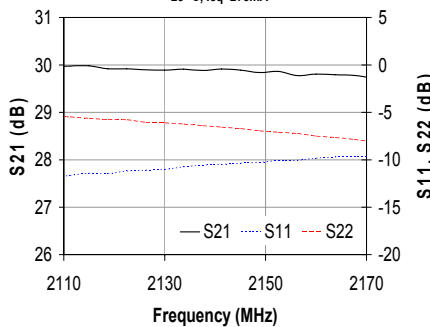

Wideband S-Parameters

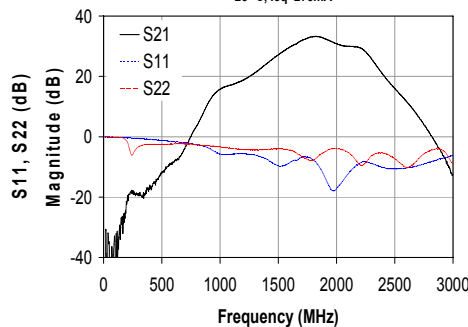

Gain / Output Power vs. Input Power

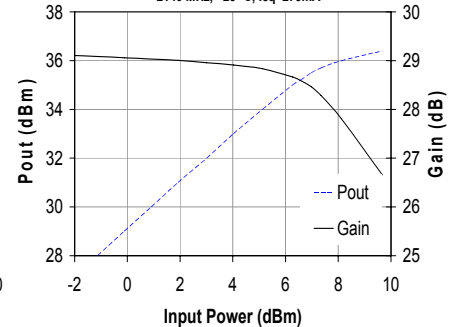

ACLR vs. Channel Power

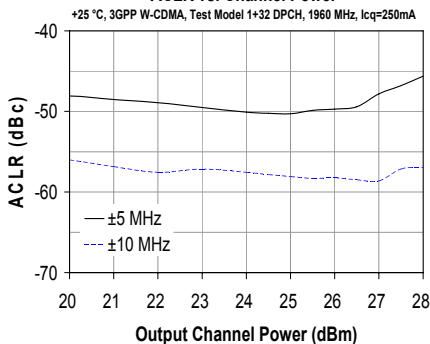

IMD3, IMD5, OIP3 vs. Output Power

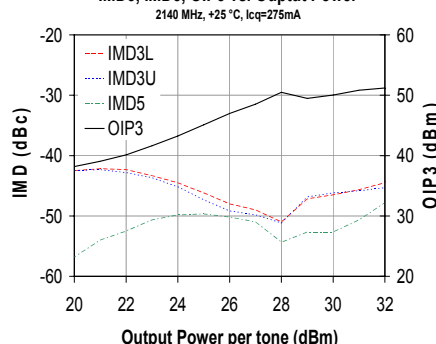

PAE / Icc vs. Output Power

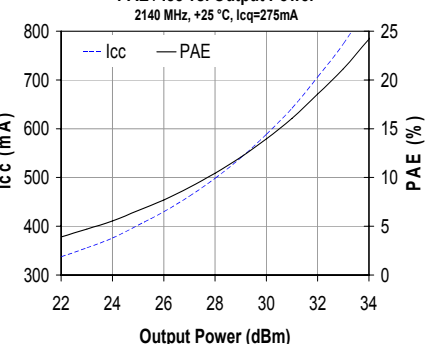



MTTF Calculation

The MTTF of the AP502 can be calculated by first determining how much power is being dissipated by the amplifier module. Because the device's intended application is to be a power amplifier pre-driver or final stage output amplifier, the output RF power of the amplifier will help lower the overall power dissipation. In addition, the amplifier can be biased with different quiescent currents, so the calculation of the MTTF is custom to each application.

The power dissipation of the device can be calculated with the following equation:

$$P_{diss} = V_{cc} * I_{cc} - (\text{Output RF Power} - \text{Input RF Power}),$$

V_{cc} = Operating supply voltage = **12V**
 I_{cc} = Operating current
 {The RF power is converted to Watts}

While the maximum recommended case temperature on the datasheet is listed at 85 °C, it is suggested that customers maintain an MTTF above 1 million hours. This would convert to a derating curve for maximum case temperature vs. power dissipation as shown in the plot below.

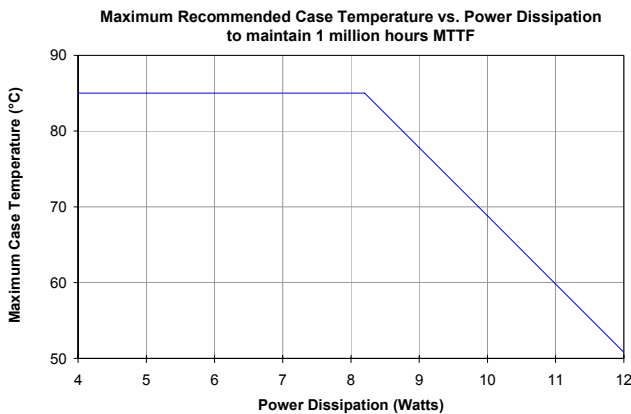

To calculate the MTTF for the module, the junction temperature needs to be determined. This can be easily calculated with the module's power dissipation, the thermal resistance value, and the case temperature of operation:

$$T_j = P_{diss} * R_{th} + T_{case}$$

T_j = Junction temperature
 P_{diss} = Power dissipation (calculated from above)
 R_{th} = Thermal resistance = **9 °C/W**
 T_{case} = Case temperature of module's heat sink

From a numerical standpoint, the MTTF can be calculated using the Arrhenius equation:

$$MTTF = A * e^{(E_a/k/T_j)}$$

A = Pre-exponential Factor = **6.087 x 10⁻¹¹ hours**
 E_a = Activation Energy = **1.39 eV**
 k = Boltzmann's Constant = **8.617 x 10⁻⁵ eV/°K**
 T_j = Junction Temperature (°K) = T_j (°C) + 273

A graphical view of the MTTF can be shown in the plot below.

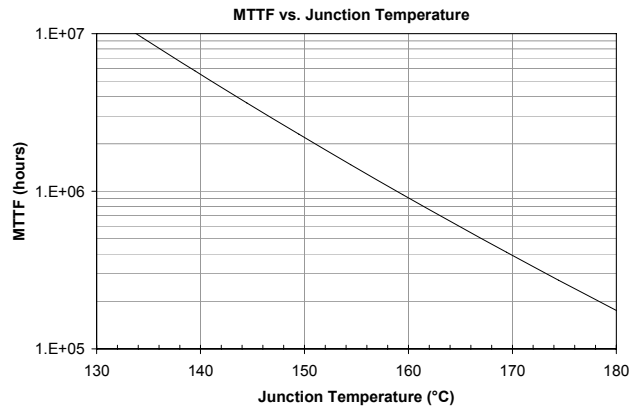



AP502

UMTS-band 4W HBT Amplifier Module

The Communications Edge™

Product Information

Outline Drawing

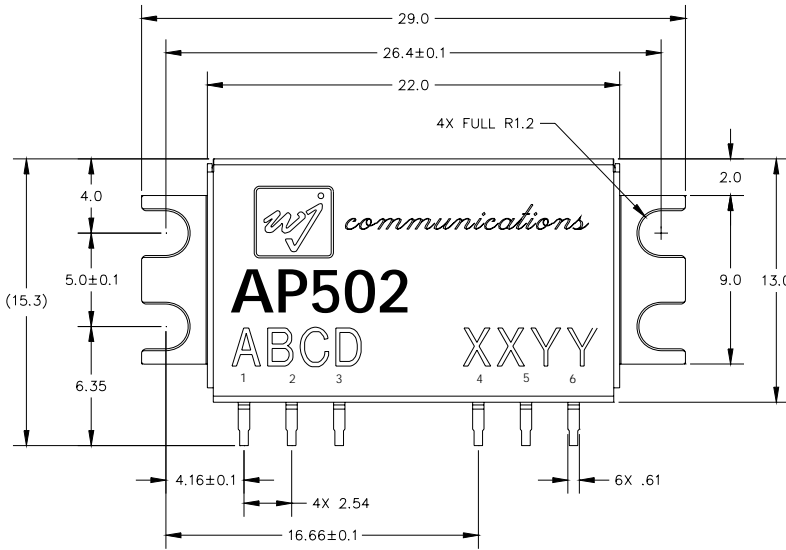

NOTES:

1. DIMENSIONING & TOLERANCING CONFORM TO ANSI Y14.4M-1994.
2. ALL DIMENSIONS ARE IN MILLIMETERS (INCHES). ANGLES ARE IN DEGREES.
3. PIN ASSIGNMENTS:
 [PIN 1] RF OUT
 [PIN 2] +12 Vcc
 [PIN 3] Vpd
 [PIN 4] +12 Vcc
 [PIN 5] Vpd
 [PIN 6] RF IN
 [CASE] GROUND

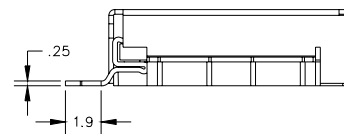
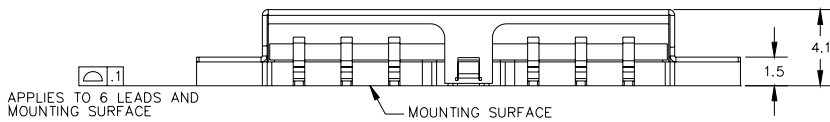

Outline Drawing for the Heatsink Shipped with the WJ Evaluation Board

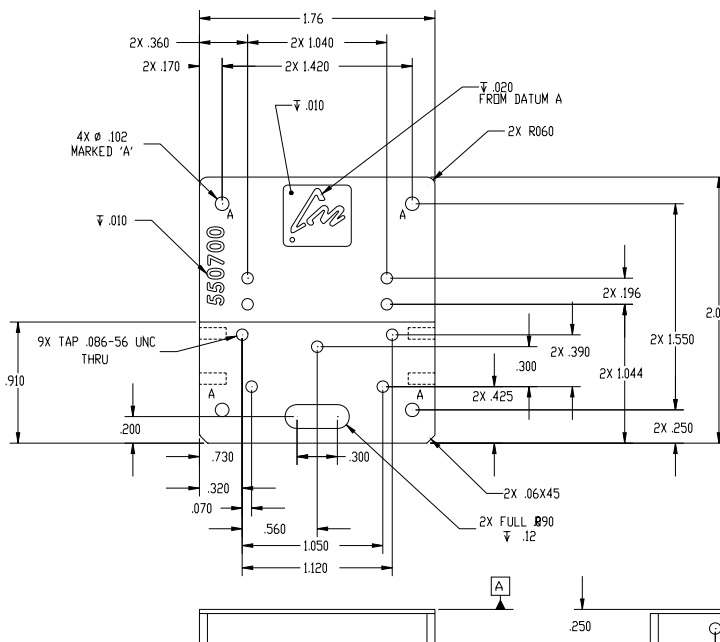

Product Marking

The device will be marked with an "AP502" designator with an alphanumeric lot code on the top surface of the package noted as "ABCD" on the drawing. A manufacturing date will also be printed as "XXYY", where the "XX" represents the week number from 1 – 52.

The product will be shipped in tubes in multiples of 15.

ESD / MSL Information



Caution! ESD sensitive device.

ESD Rating: Class 1C
 Value: Passes at $\geq 1,000$ to $< 2,000$ volts
 Test: Human Body Model (HBM)
 Standard: JEDEC Standard JESD22-A114

ESD Rating: Class III
 Value: Passes ≥ 500 to $< 1,000$ volts
 Test: Charged Device Model (CDM)
 Standard: JEDEC Standard JESD22-C101

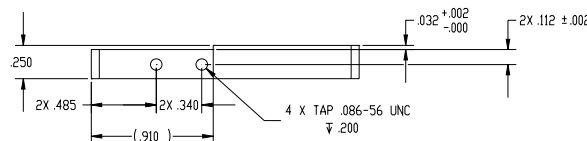

Specifications and information are subject to change without notice