

### Description

The AP7363 is a 1.5A adjustable output voltage linear regulator with ultra-low dropout. The device includes pass element, error amplifier, band-gap, current limit and thermal shutdown circuitry.

The characteristics of low dropout voltage and fast transient response to step changes in load make it suitable for low voltage microprocessor applications. The typical quiescent current is approximately 0.5mA and changes little with load current. The built-in current-limit and thermal-shutdown functions prevent IC from damage in fault conditions.

This device is available in U-DFN2030-8, SO-8EP and SOT223-3L packages.

### Features

- 1.5A ultra-low dropout linear regulator
- Ultra-low dropout: 190mV at 1.5A
- Stable with 10µF input/output capacitor, any types
- Wide input voltage range: 2.7V to 5.5V
- Adjustable output voltage: 0.6V to 5.0V
- Fixed output options: 1V, 1.2V, 1.5V, 1.8V, 2.5V, 3.3V
- Low ground pin current
- 25nA quiescent current in shutdown mode
- $V_{ADJ}$  accuracy of  $\pm 1.5\%$  @ 25°C
- $V_{ADJ}$  accuracy of  $\pm 3\%$  over line, load and temperature
- Excellent Load/Line Transient Response
- Current limit and thermal shutdown protection
- Ambient temperature range: -40°C to 85°C
- U-DFN2030-8, SO-8EP, SOT223-3L: Available in "Green" Molding Compound (No Br, Sb)
- Lead Free Finish/ RoHS Compliant (Note 1)

### Applications

- ASIC power supplies in printers, graphics cards, DVD players, STBs, routers, etc
- FPGA and DSP core or I/O power supplies
- SMPS regulator
- Conversion from 3.3V or 5V rail

Notes: 1. EU Directive 2002/95/EC (RoHS). All applicable RoHS exemptions applied. Please visit our website at [http://www.diodes.com/products/lead\\_free.html](http://www.diodes.com/products/lead_free.html).

### Pin Assignments

(Top View)

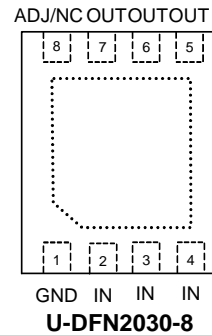

(Top View)

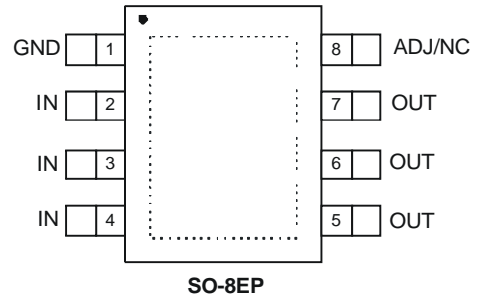

(Top View)

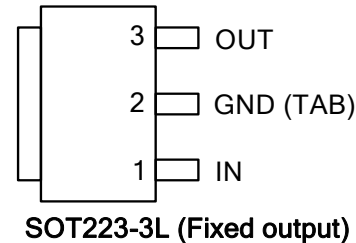

**Typical Application Circuit**

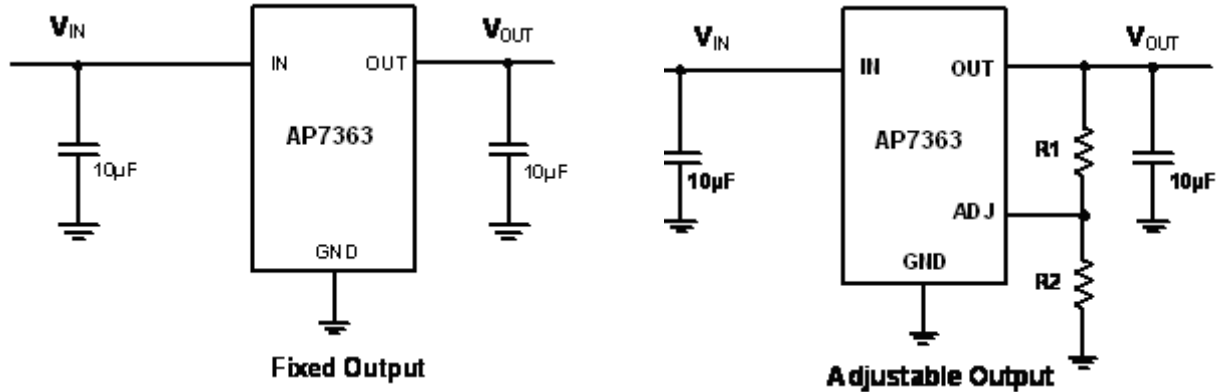

$$V_{OUT} = V_{REF} \left( 1 + \frac{R_1}{R_2} \right) \text{ where } R_2 \leq 10k\Omega$$

**Pin Descriptions**

Pin Name	Pin Number	Description
GND	1	Ground.
IN	2, 3, 4	Voltage input pin.
OUT	5, 6, 7	Voltage output pin.
ADJ	8	Output feedback pin for adjustable version only – a resistor divider from this pin to the OUT pin and ground sets the output voltage.
NC	8	No connection for fixed output version.
EP/TAB	--	The exposed pad (EP) is used to remove heat from the package and it is recommended that it is connected to a copper area. The die is electrically connected to the exposed pad. It is recommended to connect it externally to GND, but should not be the only ground connection.

**Functional Block Diagram**

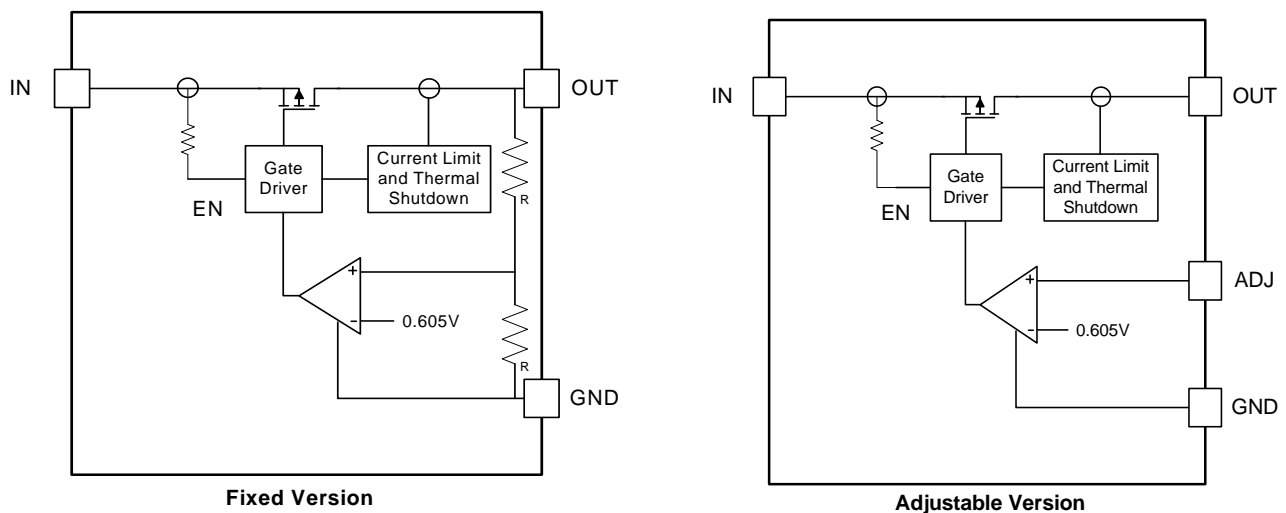

## 1.5A, LOW QUIESCENT CURRENT, FAST TRANSIENT ULTRA-LOW DROPOUT LINEAR REGULATOR

### Absolute Maximum Ratings (Note 2)

Symbol	Parameter	Ratings	Unit
ESD HBM	Human Body Model ESD Protection	2000	V
ESD MM	Machine Model ESD Protection	200	V
$V_{IN}$	Input Voltage	-0.3 to 6.0	V
$V_{OUT}$	OUT Voltage	-0.3V to $V_{IN} + 0.3$	V
$I_{OUT}$	Continuous Load Current	Internal Limited	
$T_{ST}$	Storage Temperature Range	-65 to 150	°C
$T_J$	Maximum Junction Temperature	150	°C

Notes: 2. Stresses beyond those listed under *Absolute Maximum Ratings* may cause permanent damage to the device. These are stress Ratings only, and functional operation of the device at these or any other conditions beyond those indicated is not implied. Exposure to absolute-maximum rated conditions for extended periods may affect device reliability.

### Recommended Operating Conditions

Symbol	Parameter	Min	Max	Unit
$V_{IN}$	Input voltage	2.7	5.5	V
$I_{OUT}$	Output Current	0	1.5	A
$T_A$	Operating Ambient Temperature	-40	85	°C
$T_J$	Operating Junction Temperature (Note 3)	-40	125	°C

Notes: 3. Operating junction temperature must be evaluated and derated as needed, based on ambient temperature ( $T_A$ ), power dissipation ( $P_D$ ), maximum allowable operating junction temperature ( $T_{J-MAX}$ ), and package thermal resistance ( $\theta_{JA}$ ).

## 1.5A, LOW QUIESCENT CURRENT, FAST TRANSIENT ULTRA-LOW DROPOUT LINEAR REGULATOR

### Electrical Characteristics

$T_A = 25^\circ\text{C}$ ,  $V_{IN} = 3.3\text{V}$ ,  $V_{OUT} = 1.8\text{V}$ ,  $I_{OUT} = 10\text{mA}$ ,  $C_{IN} = 10\mu\text{F}$ ,  $C_{OUT} = 10\mu\text{F}$ , unless otherwise stated.

Minimum and maximum limits are guaranteed through test, design, or statistical correlation. Typical values represent the most likely parametric norm at  $T_A = 25^\circ\text{C}$ , and are provided for reference purposes only.

Symbol	Parameter	Test Conditions	Min	Typ.	Max	Unit	
$V_{ADJ}$	ADJ Pin Voltage	$V_{IN} = V_{IN-Min}$ to $V_{IN-Max}$ , $I_{OUT} = 10\text{mA}$ to $1.5\text{A}$	$T_A = 25^\circ\text{C}$	0.584	0.605	0.626	V
			Over temp	0.575		0.635	
$V_{ADJ}$	ADJ Pin Voltage (A Grade)	$V_{IN} = V_{IN-Min}$ to $V_{IN-Max}$ , $I_{OUT} = 10\text{mA}$ to $1.5\text{A}$	$T_A = 25^\circ\text{C}$	0.596	0.605	0.614	V
			Over temp	0.587		0.623	
$I_{ADJ}$	ADJ Pin Bias Current	$V_{IN} = V_{IN-Min}$ to $V_{IN-Max}$	$T_A = 25^\circ\text{C}$		50		nA
			Over temp			750	
$V_{Dropout}$	Dropout Voltage (Note 4)	$I_{OUT} = 1.5\text{A}$ , $V_{OUT} = 2.5\text{V}$	$T_A = 25^\circ\text{C}$		190	240	mV
			Over temp			280	
$\Delta V_{OUT} / \Delta V_{IN}$	Line Regulation (Note 5)	$V_{IN} = V_{IN-Min}$ to $V_{IN-Max}$	$T_A = 25^\circ\text{C}$	-	0.04	-	% / V
			Over temp		0.05		
$\Delta V_{OUT} / \Delta I_{OUT}$	Load Regulation (Note 5)	$I_{OUT} = 10\text{mA}$ to $1.5\text{A}$	$T_A = 25^\circ\text{C}$	-	0.18	-	% / A
			Over temp		0.33		
$I_{GND}$	Ground Pin Current in Normal Operation Mode	$I_{OUT} = 10\text{mA}$ to $1.5\text{A}$	$T_A = 25^\circ\text{C}$		1.0	1.2	mA
			Over temp			1.3	
$I_{OUT-PK}$	Peak Output Current	$V_{OUT} \geq V_{OUT-NOM} - 5\%$			3.6	A	
$I_{SC}$	Short Circuit Current	OUT grounded	$T_A = 25^\circ\text{C}$		3.7		A
			Over temp	2			
$t_{d(off)}$	Turn-off delay	From $V_{EN} < V_{IL}$ to $V_{OUT} = \text{OFF}$ , $I_{OUT} = 1.5\text{A}$		25		$\mu\text{s}$	
$t_{d(on)}$	Turn-on delay	From $V_{EN} > V_{IH}$ to $V_{OUT} = \text{ON}$ , $I_{OUT} = 1.5\text{A}$		25		$\mu\text{s}$	
PSRR	Ripple Rejection	$V_{IN} = 3.0\text{V}$ , $I_{OUT} = 1.5\text{A}$ , $f = 120\text{Hz}$		65		dB	
		$V_{IN} = 3.0\text{V}$ , $I_{OUT} = 1.5\text{A}$ , $f = 1\text{kHz}$		61			
$\rho_n(f)$	Output Noise Density	$F = 120\text{Hz}$ , $C_{OUT} = 10\mu\text{F}$ ceramic		1.0		$\mu\text{V}/\sqrt{\text{Hz}}$	
$e_n$	Output Noise Voltage	$BW = 100\text{Hz} - 100\text{kHz}$ , $C_{OUT} = 10\mu\text{F}$ ceramic		100		$\mu\text{V}(\text{rms})$	
$T_{SHDN}$	Thermal shutdown threshold	$T_J$ rising		170		$^\circ\text{C}$	
$T_{HYS}$	Thermal shutdown hysteresis	$T_J$ falling from $T_{SHDN}$		10		$^\circ\text{C}$	
$\theta_{JA}$	Thermal Resistance Junction-to-Ambient	U-DFN2030-8-8 (Note 6)		174.0		$^\circ\text{C}/\text{W}$	
		SO-8EP (Note 6)		52.8			
		SOT223-3L (Note 6)		105.7			
$\theta_{JC}$	Thermal Resistance Junction-to-Case	U-DFN2030-8-8 (Note 6)		28.2		$^\circ\text{C}/\text{W}$	
		SO-8EP (Note 6)		10.0			
		SOT223-3L (Note 6)		18.5			

- Notes:
- Dropout voltage is the minimum voltage difference between the input and the output at which the output voltage drops 2% below its nominal value. For any output voltage less than 2.5V, the minimum  $V_{IN}$  operating voltage is the limiting factor.
  - The line and load regulation specification contains only the typical number. However, the limits for line and load regulation are included in the adjust voltage tolerance specification.
  - Device mounted on 2" x 2" FR-4 substrate PCB, 2oz copper with minimum recommended pad layout.

**Typical Performance Characteristics**

Unless otherwise specified:  $T_J=25^\circ\text{C}$ ,  $V_{IN}=2.7\text{V}$ ,  $C_{IN}=10\mu\text{F}$ ,  $C_{OUT}=10\mu\text{F}$ ,  $I_{OUT}=10\text{mA}$ ,  $V_{OUT}=1.8\text{V}$

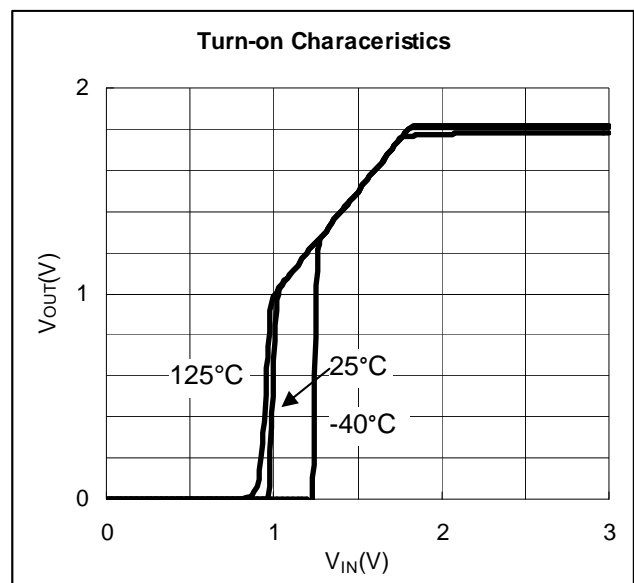
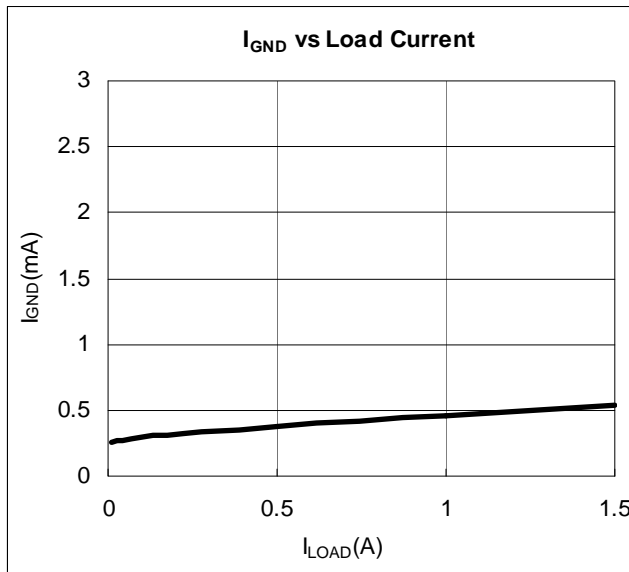
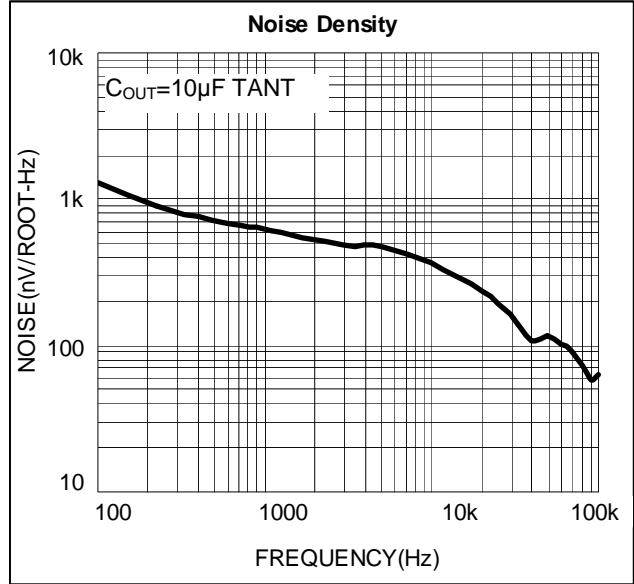
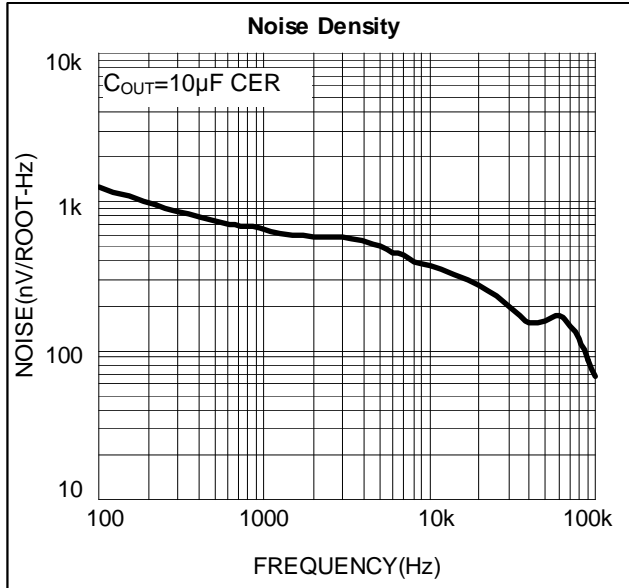

**1.5A, LOW QUIESCENT CURRENT, FAST TRANSIENT  
ULTRA-LOW DROPOUT LINEAR REGULATOR**

NEW PRODUCT

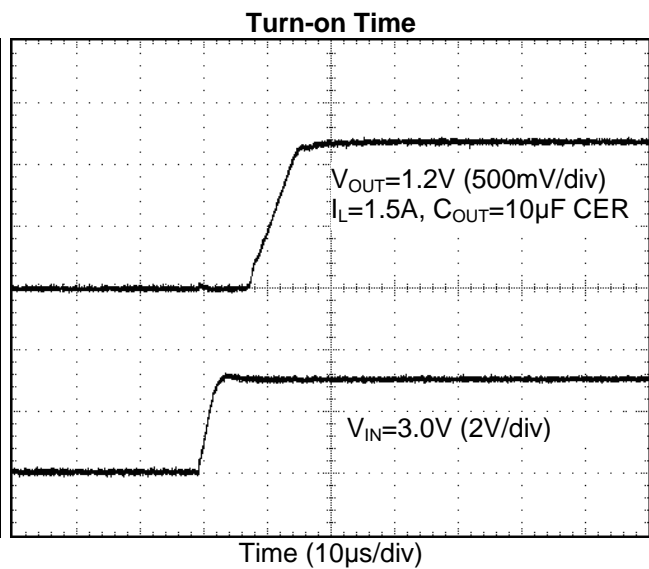
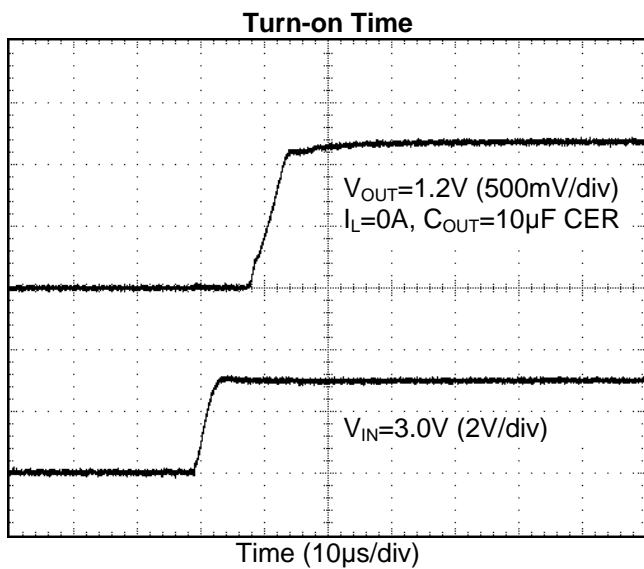
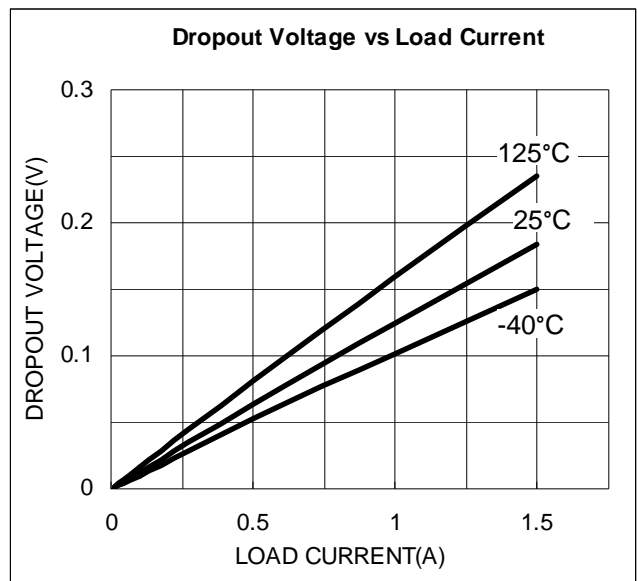
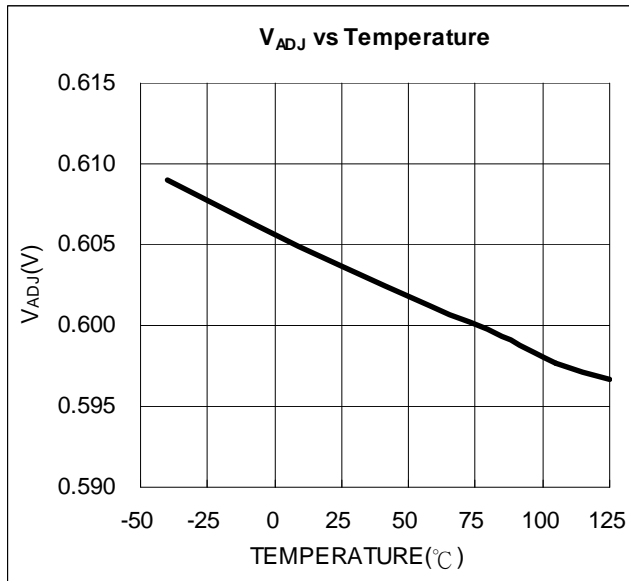

**Load Transient Response**

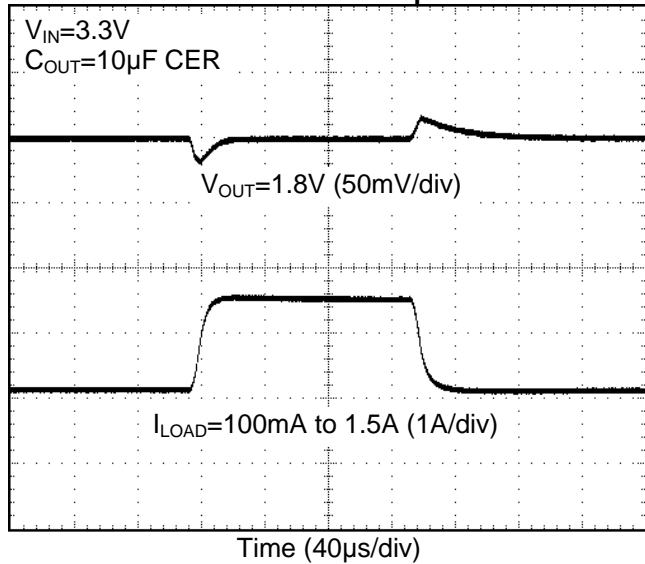

**PSRR**

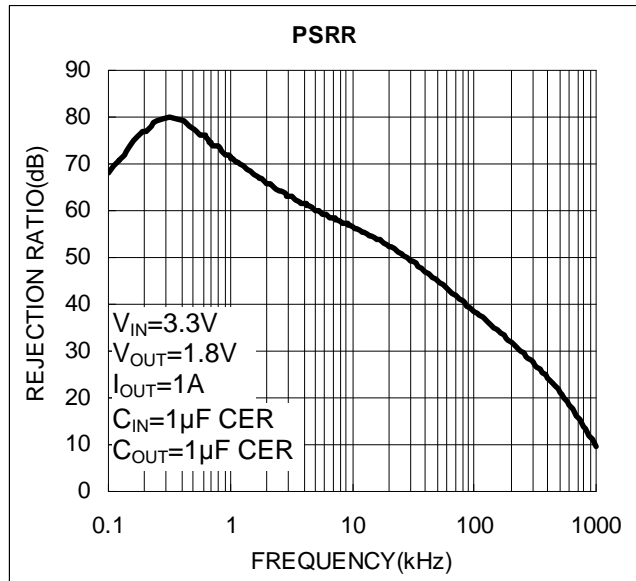

NEW PRODUCT

**Application Note**

**Input Capacitor**

A minimum 2.2µF ceramic capacitor is recommended between IN and GND pins to decouple input power supply glitch and noise. The amount of the capacitance may be increased without limit. Larger input capacitor like 10µF will provide better load transient response. This input capacitor must be located as close as possible to the device to assure input stability and reduce noise. For PCB layout, a wide copper trace is required for both IN and GND pins. A lower ESR capacitor type allows the use of less capacitance, while higher ESR type requires more capacitance.

**Output Capacitor**

The output capacitor is required to stabilize and help the transient response of the LDO. The AP7362 is stable with any type of capacitor, with no limitations on minimum or maximum ESR. The device is designed to have excellent transient response for most applications with a small amount of output capacitance. The device is also stable with multiple capacitors in parallel, which can be of any type of value. Additional capacitance helps to reduce undershoot and overshoot during transient loads. This capacitor should be placed as close as possible to OUT and GND pins for optimum performance.

**Adjustable Operation**

The AP7362 provides output voltage from 0.6V to 5.0V through external resistor divider as shown below.

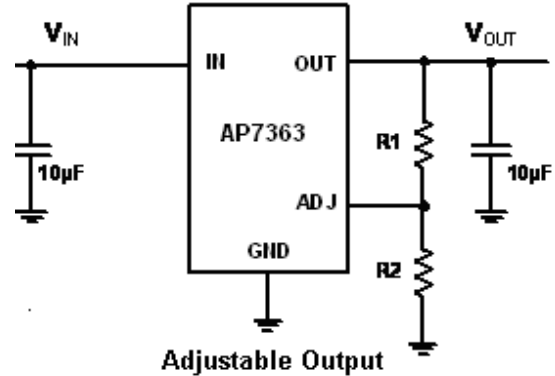

The output voltage is calculated by:

$$V_{OUT} = V_{REF} \left( 1 + \frac{R_1}{R_2} \right)$$

Where  $V_{REF}=0.6V$  (the internal reference voltage)

Rearranging the equation will give the following that is used for adjusting the output to a particular voltage:

$$R_1 = R_2 \left( \frac{V_{OUT}}{V_{REF}} - 1 \right)$$

To maintain the stability of the internal reference voltage,  $R_2$  need to be kept smaller than 10kΩ.

**Application Note (cont.)**

**No Load Stability**

Other than external resistor divider, no minimum load is required to keep the device stable. The device will remain stable and regulated in no load condition.

**Stability and Phase Margin**

Any regulator which operates using a feedback loop must be compensated in such a way as to ensure adequate phase margin, which is defined as the difference between the phase shift and -180 degrees at the frequency where the loop gain crosses unity (0 dB). For most LDO regulators, the ESR of the output capacitor is required to create a zero to add enough phase lead to ensure stable operation. The AP7362 has a internal compensation circuit which maintains phase margin regardless of the ESR of the output capacitor, any type of capacitors can be used.

Below two charts show the gain/phase plot of the AP7362 with an output of 1.2V, 10 μF ceramic output capacitor, delivering 1.5A load current and no load. It can be seen the phase margin is about 90° (which is very stable).

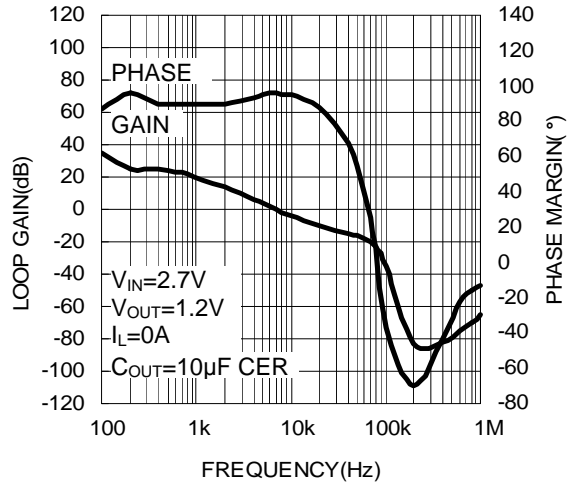

**Gain-Bandwidth Plot for no Load**

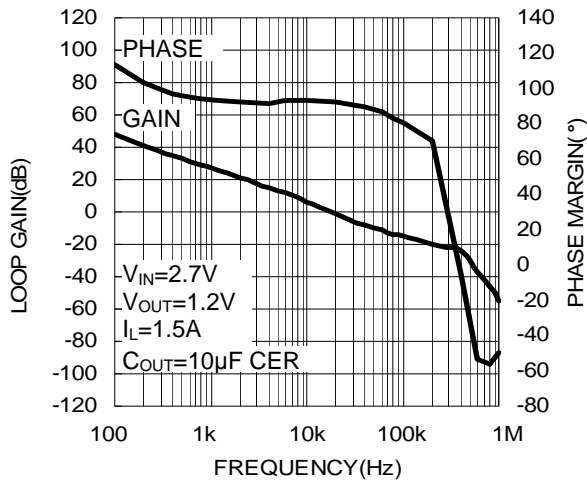

**Gain-Bandwidth Plot for 1.5A Load**

**Short Circuit Protection**

When output current at OUT pin is higher than current limit threshold, the current limit protection will be triggered and clamp the output current to prevent over-current and to protect the regulator from damage due to overheating.

**Thermal Shutdown Protection**

Thermal protection disables the output when the junction temperature rises to approximately +170°C, allowing the device to cool down. When the junction temperature reduces to approximately +160°C the output circuitry is enabled again. Depending on power dissipation, thermal resistance, and ambient temperature, the thermal protection circuit may cycle on and off. This cycling limits the heat dissipation of the regulator, protecting it from damage due to overheating.

**Low Quiescent Current**

The AP7362, consuming only around 0.5mA for all input range, provides great power saving in portable and low power applications.



### Application Note (cont.)

#### Output Noise

This is the integrated value of the output noise over a specified frequency range. Input voltage and output load current are kept constant during the measurement. Results are expressed in  $\mu\text{Vrms}$  or  $\mu\text{V}/\sqrt{\text{Hz}}$ .

The AP7362 is a low noise regulator and needs no external noise reduction capacitor. Output voltage noise is typically  $100\mu\text{Vrms}$  overall noise level between 100 Hz and 100 kHz

Noise is specified in two ways:

**Output noise density** is the RMS sum of all noise sources, measured at the regulator output, at a specific frequency (measured with a 1Hz bandwidth). This type of noise is usually plotted on a curve as a function of frequency.

**Output noise voltage** is the RMS sum of spot noise over a specified bandwidth. Spot noise is measured in units  $\mu\text{V}/\sqrt{\text{Hz}}$  or  $\text{nV}/\sqrt{\text{Hz}}$  and total output noise is

measured in  $\mu\text{V}(\text{rms})$ . The primary source of noise in low-dropout regulators is the internal reference.

#### Power Dissipation

The device power dissipation and proper sizing of the thermal plane that is connected to the thermal pad is critical to avoid thermal shutdown and ensure reliable operation. Power dissipation of the device depends on input voltage and load conditions and can be calculated by:

$$P_D = (V_{IN} - V_{OUT}) \times I_{OUT}$$

The maximum power dissipation, handled by the device, depends on the junction to ambient thermal resistance, and maximum ambient temperature, which can be calculated by the equation in the following:

$$P_{D\_max} = \frac{(+150^\circ\text{C} - T_A)}{R_{\theta JA}}$$

### Ordering Information

AP 7363 - XX XX - X

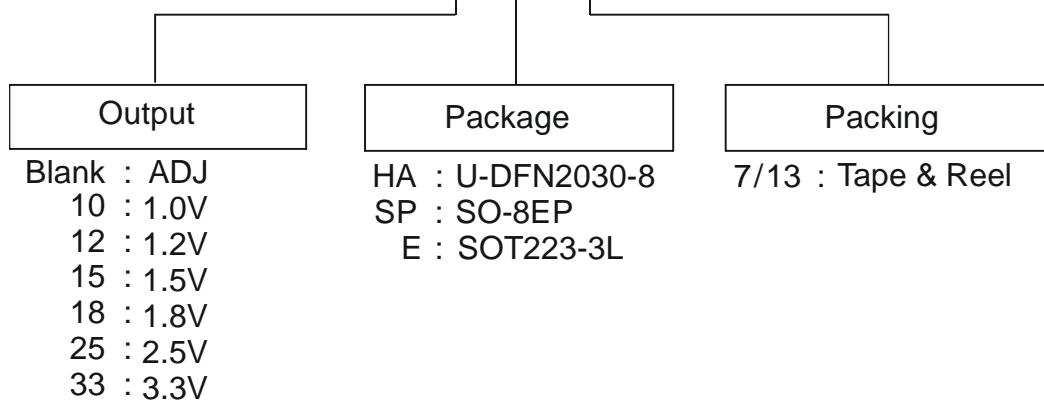

Device	Package Code	Packaging (Note 7 & 8)	7"/13" Tape and Reel	
			Quantity	Part Number Suffix
AP7363-XXHA-7	HA	U-DFN2030-8	3000/Tape & Reel	-7
AP7363-XXSP-13	SP	SO-8EP	2500/Tape & Reel	-13
AP7363-XXE-13	E	SOT223-3L	2500/Tape & Reel	-13

Notes: 7. SOT223-3L is only available with fixed output version.

8. Pad layout as shown on Diodes Inc. suggested pad layout document AP02001, which can be found on our website at <http://www.diodes.com/datasheets/ap02001.pdf>.

### Marking Information

#### (1) U-DFN2030--8

( Top View )

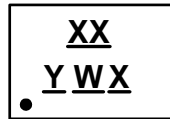

XX : Identification Code  
Y : Year : 0~9  
W : Week : A~Z : 1~26 week;  
a~z : 27~52 week; z represents  
52 and 53 week  
X : G : Green

Device	Package	Identification Code
AP7363ADJ	U-DFN2030-8	SA
AP7363-10	U-DFN2030-8	SB
AP7363-12	U-DFN2030-8	SC
AP7363-15	U-DFN2030-8	SD
AP7363-18	U-DFN2030-8	SE
AP7363-25	U-DFN2030-8	SF
AP7363-33	U-DFN2030-8	SG

#### (2) SO-8EP

( Top View )

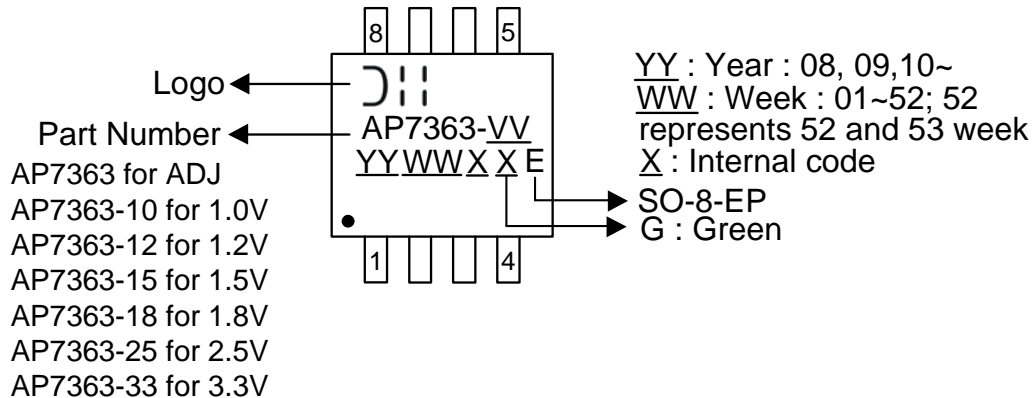

**Marking Information (continued)**

**(3) SOT223-3L**

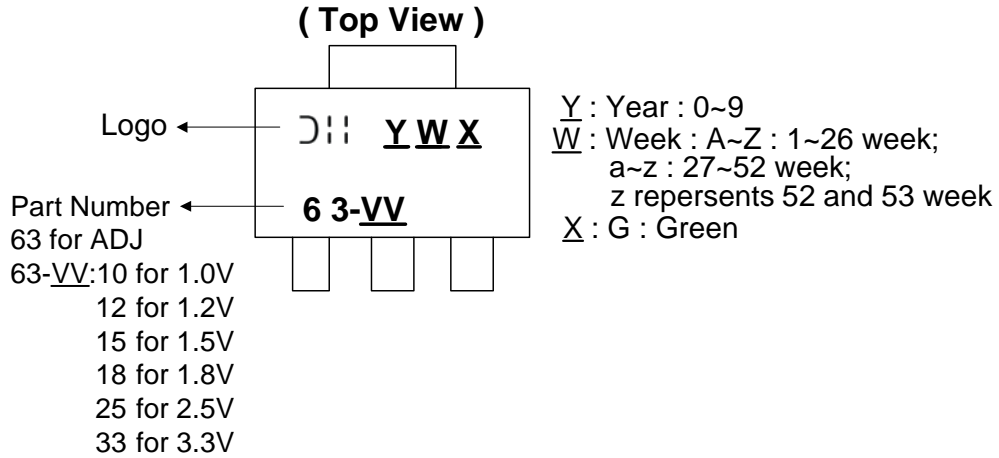

**Package Outline Dimensions (All Dimensions in mm)**

**(1) Package Type: U-DFN2030-8**

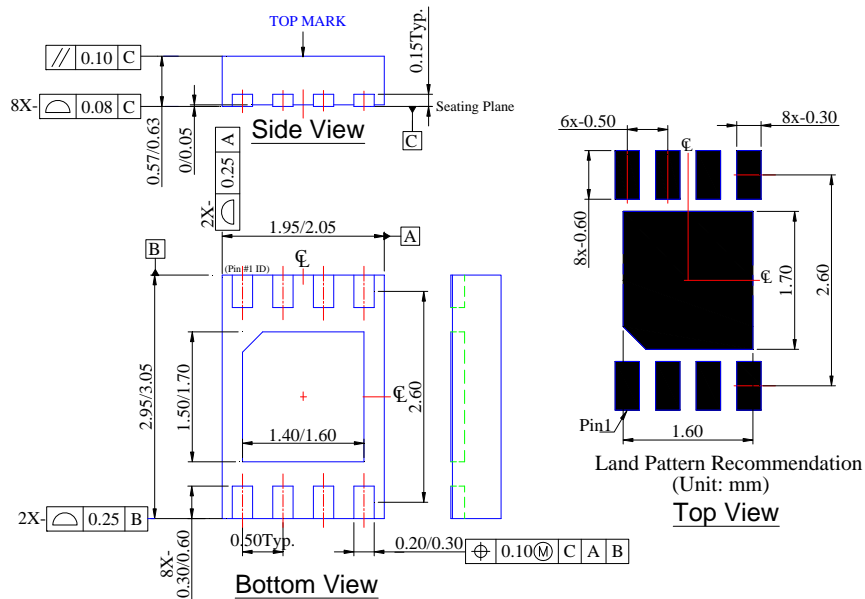

NEW PRODUCT

**1.5A, LOW QUIESCENT CURRENT, FAST TRANSIENT  
ULTRA-LOW DROPOUT LINEAR REGULATOR**

**Package Outline Dimensions (All Dimensions in mm) (cont.)**

**(2) Package Type: SO-8EP**

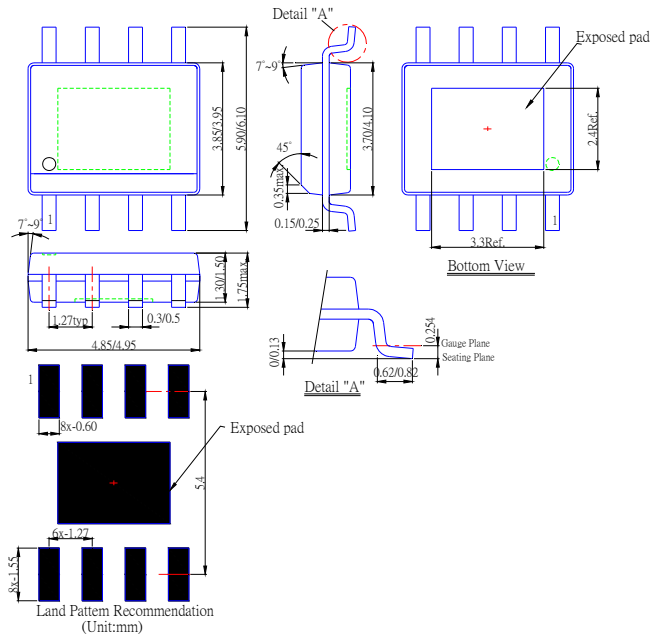

**(3) Package Type: SOT223-3L**

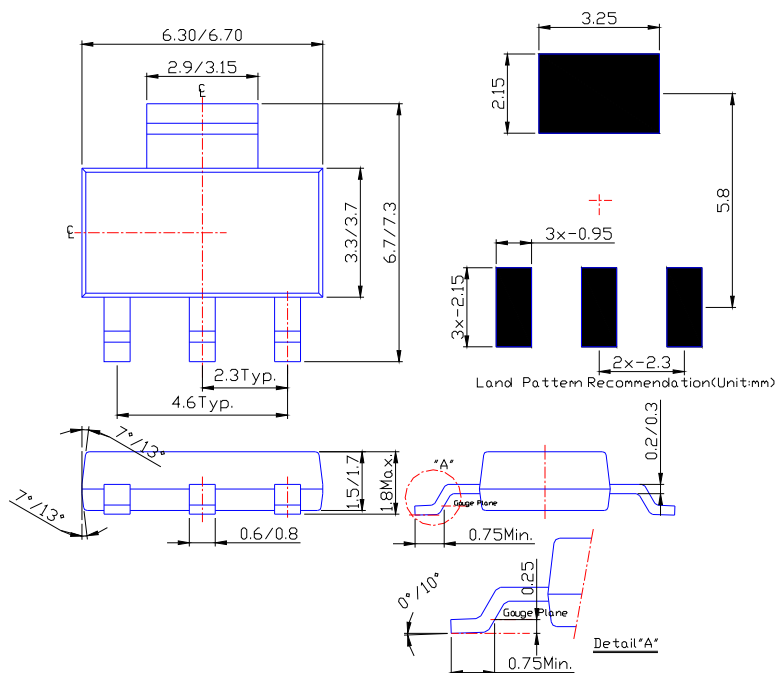

Notes: 9. Coplanarity applies to the exposed heat sink slug as well as the terminals.

**Taping Orientation (Note 10)**

Tape Dimension and Orientation: (Dimensions in mm)

**U-DFN2030-8**

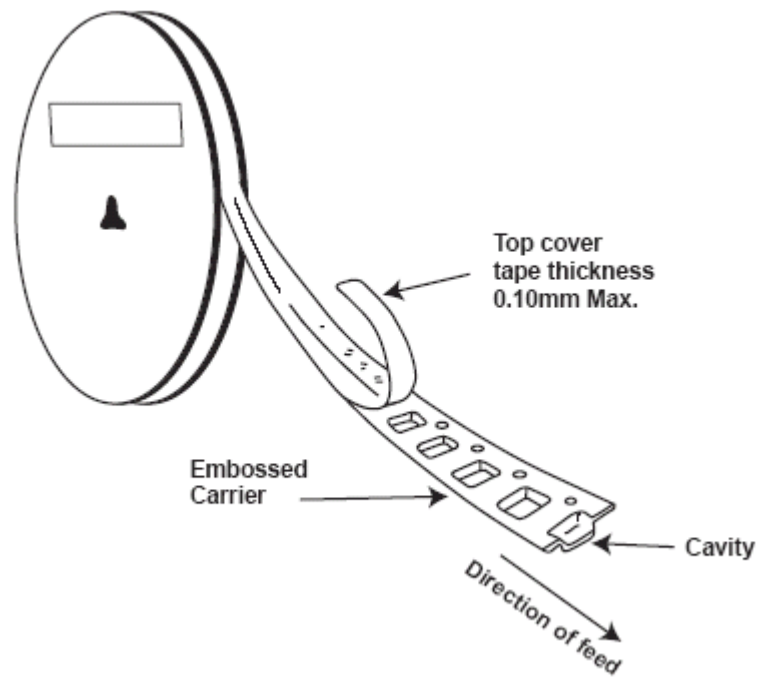
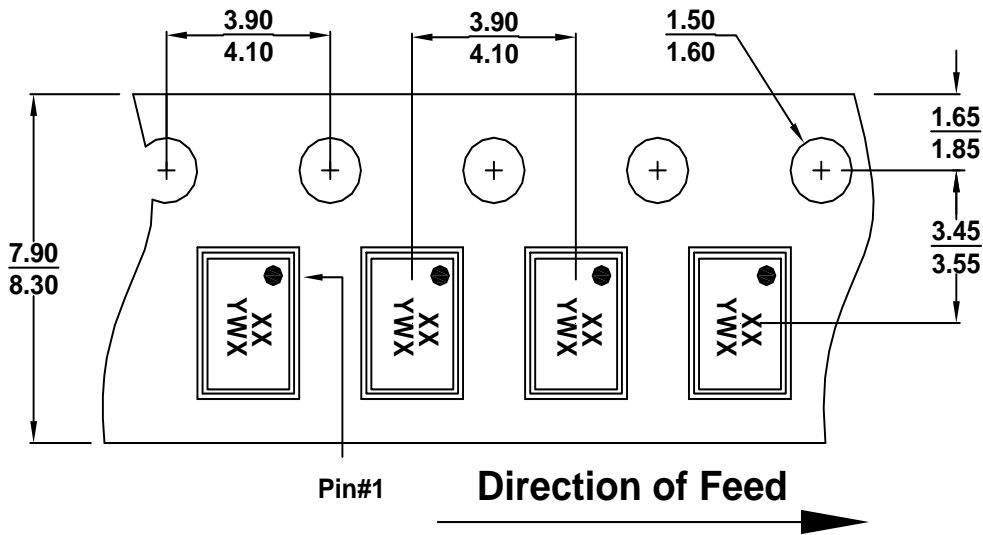

Note: 10. The taping orientation of the other package type can be found on our website at <http://www.diodes.com/datasheets/ap02007.pdf>

**1.5A, LOW QUIESCENT CURRENT, FAST TRANSIENT  
ULTRA-LOW DROPOUT LINEAR REGULATOR****IMPORTANT NOTICE**

DIODES INCORPORATED MAKES NO WARRANTY OF ANY KIND, EXPRESS OR IMPLIED, WITH REGARDS TO THIS DOCUMENT, INCLUDING, BUT NOT LIMITED TO, THE IMPLIED WARRANTIES OF MERCHANTABILITY AND FITNESS FOR A PARTICULAR PURPOSE (AND THEIR EQUIVALENTS UNDER THE LAWS OF ANY JURISDICTION).

Diodes Incorporated and its subsidiaries reserve the right to make modifications, enhancements, improvements, corrections or other changes without further notice to this document and any product described herein. Diodes Incorporated does not assume any liability arising out of the application or use of this document or any product described herein; neither does Diodes Incorporated convey any license under its patent or trademark rights, nor the rights of others. Any Customer or user of this document or products described herein in such applications shall assume all risks of such use and will agree to hold Diodes Incorporated and all the companies whose products are represented on Diodes Incorporated website, harmless against all damages.

Diodes Incorporated does not warrant or accept any liability whatsoever in respect of any products purchased through unauthorized sales channel.

Should Customers purchase or use Diodes Incorporated products for any unintended or unauthorized application, Customers shall indemnify and hold Diodes Incorporated and its representatives harmless against all claims, damages, expenses, and attorney fees arising out of, directly or indirectly, any claim of personal injury or death associated with such unintended or unauthorized application.

Products described herein may be covered by one or more United States, international or foreign patents pending. Product names and markings noted herein may also be covered by one or more United States, international or foreign trademarks.

**LIFE SUPPORT**

Diodes Incorporated products are specifically not authorized for use as critical components in life support devices or systems without the express written approval of the Chief Executive Officer of Diodes Incorporated. As used herein:

A. Life support devices or systems are devices or systems which:

1. are intended to implant into the body, or
2. support or sustain life and whose failure to perform when properly used in accordance with instructions for use provided in the labeling can be reasonably expected to result in significant injury to the user.

B. A critical component is any component in a life support device or system whose failure to perform can be reasonably expected to cause the failure of the life support device or to affect its safety or effectiveness.

Customers represent that they have all necessary expertise in the safety and regulatory ramifications of their life support devices or systems, and acknowledge and agree that they are solely responsible for all legal, regulatory and safety-related requirements concerning their products and any use of Diodes Incorporated products in such safety-critical, life support devices or systems, notwithstanding any devices- or systems-related information or support that may be provided by Diodes Incorporated. Further, Customers must fully indemnify Diodes Incorporated and its representatives against any damages arising out of the use of Diodes Incorporated products in such safety-critical, life support devices or systems.

Copyright © 2011, Diodes Incorporated

[www.diodes.com](http://www.diodes.com)