

Stereo 2.6W Audio Power Amplifier (with DC_Volume Control)

Features

- Low Operating Current with 9mA
- Improved Depop Circuitry to Eliminate Turn-on and Turn-off Transients in Outputs
- High PSRR
- 32 Steps Volume Adjustable by DC Voltage with Hysteresis
- 2.6W per Channel Output Power into 4Ω Load at 5V,BTL Mode
- Two Output Modes Allowable with BTL and SE Modes Selected by SE/BTL pin
- Low Current Consumption in Shutdown Mode (1μA)
- Short Circuit Protection
- Thermal shutdown protection and over current protection circuitry
- Power DIP-16 Package
- Lead Free Available (RoHS Compliant)

General Description

APA2069 is a monolithic integrated circuit, which provides precise DC volume control, and a stereo bridged audio power amplifiers capable of producing 2.6W (1.8W) into 4Ω with less than 10% (1.0%)THD+N. The attenuator range of the volume control in APA2069 is from 20dB (DC_Vol=0V) to -80dB (DC_Vol=3.54V) with 32 steps. The advantage of internal gain setting can be less components and PCB area. Both of the depop circuitry and the thermal shutdown protection circuitry are integrated in APA2069, that reduce pops and clicks noise during power up or shutdown mode operation. It also improves the power off pop noise and protects the chip from being destroyed by over temperature and short current failure. To simplify the audio system design, APA2069 combines a stereo bridge-tied loads (BTL) mode for speaker drive and a stereo single-end (SE) mode for headphone drive into a single chip, where both modes are easily switched by the SE/BTL input control pin signal.

Applications

- Notebook PC
- LCD Monitor or TV

ANPEC reserves the right to make changes to improve reliability or manufacturability without notice, and advise customers to obtain the latest version of relevant information to verify before placing orders.

Ordering and Marking Information

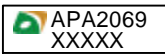
<p>APA2069 □□-□□□</p> <ul style="list-style-type: none"> □□ - Lead Free Code □□ - Handling Code □ - Temp. Range □ - Package Code 	<p>Package Code J : PDIP-16 Operating Ambient Temp. Range I : - 40 to 85 °C Handling Code TU : Tube Lead Free Code L : Lead Free Device Blank : Original Device</p>
<p>APA2069 J :  XXXXX</p>	<p>XXXXX - Date Code</p>

Note: ANPEC lead-free products contain molding compounds/die attach materials and 100% matte tin plate termination finish; which are fully compliant with RoHS and compatible with both SnPb and lead-free soldering operations. ANPEC lead-free products meet or exceed the lead-free requirements of IPC/JEDEC J STD-020C for MSL classification at lead-free peak reflow temperature.

Block Diagram

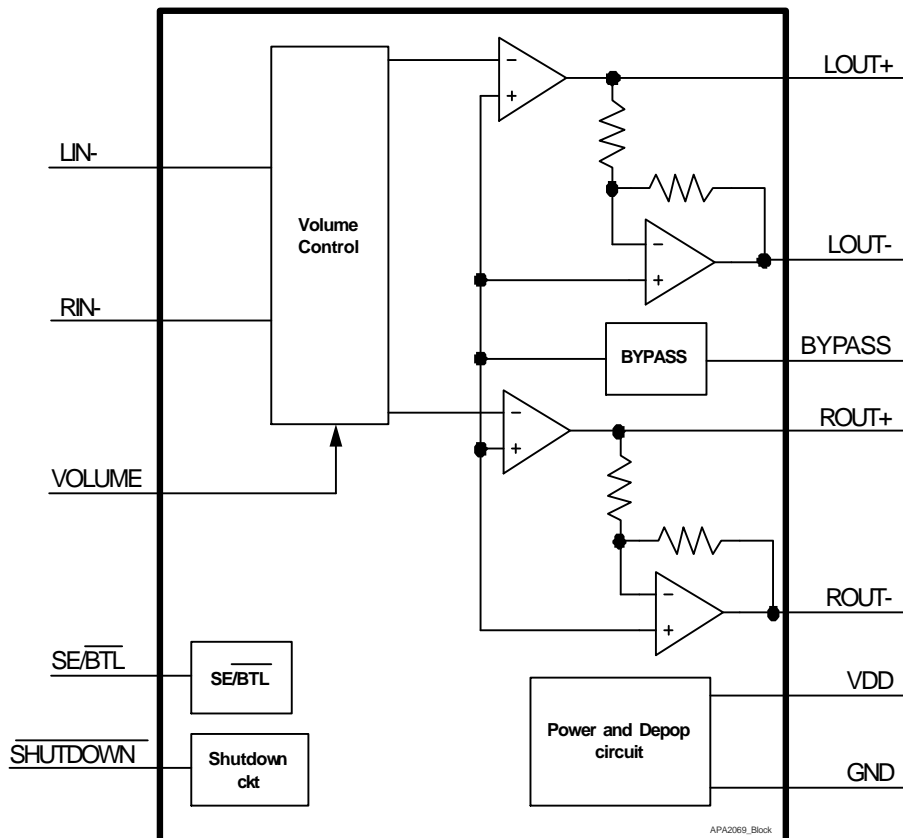

Absolute Maximum Ratings

(Over operating free-air temperature range unless otherwise noted.)

Symbol	Parameter	Rating	Unit
V_{DD}	Supply Voltage Range	-0.3 to 6	V
V_{IN}	Input Voltage Range, SE/ \overline{BTL} , SHUTDOWN	-0.3 to $V_{DD}+0.3$	V
T_A	Operating Ambient Temperature Range	-40 to 85	°C
T_J	Maximum Junction Temperature	Internal Limited* ¹	°C
T_{STG}	Storage Temperature Range	-65 to +150	°C
T_S	Soldering Temperature, 10 seconds	260	°C
V_{ESD}	Electrostatic Discharge	-3000 to 3000* ² -200 to 200* ³	V
P_D	Power Dissipation	Internal Limited	

Notes:

- 1.APA2069 integrated internal thermal shutdown protection when junction temperature ramp up to 150°C
- 2.Human body model: C=100pF, R=1500Ω, 3 positives pulse plus 3 negative pulses
- 3.Machine model: C=200pF, L=0.5μF, 3 positive pulses plus 3 negative pulses

Recommended Operating Conditions

		Min.	Max.	Unit
Supply Voltage, V_{DD}		4.5	5.5	V
High level threshold voltage, V_{IH}	SHUTDOWN	2		V
	SE/ \overline{BTL}	4		
Low level threshold voltage, V_{IL}	SHUTDOWN		1.0	V
	SE/ \overline{BTL}		3	
Common mode input voltage, V_{ICM}		$V_{DD}-1.0$		V

Thermal Characteristics

Symbol	Parameter	Value	Unit
R_{THJA}	Thermal Resistance from Junction to Ambient in Free Air DIP-16	45	°C/W

Electrical Characteristics

$V_{DD}=5V$, $-20^{\circ}C < T_A < 85^{\circ}C$ (unless otherwise noted)

Symbol	Parameter	Test Condition	APA2069			Unit
			Min.	Typ.	Max.	
V_{DD}	Supply Voltage		4.5		5.5	V
I_{DD}	Supply Current	$SE/\overline{BTL}=0V$		9	20	mA
		$SE/\overline{BTL}=5V$		4	10	
I_{SD}	Supply Current in Shutdown Mode	$SE/\overline{BTL}=0V$ $SHUTDOWN=0V$		1		μA
I_{IH}	High input Current			900		nA
I_{IL}	Low Input Current			900		nA
V_{OS}	Output Differential Voltage			5		mV

Operating Characteristics, BTL mode.

$V_{DD}=5V$, $T_A=25^{\circ}C$, $R_L=4\Omega$, Gain=2V/V (unless otherwise noted)

Symbol	Parameter	Test Condition	APA2069			Unit
			Min.	Typ.	Max.	
P_o	Maximum Output Power	THD=10%, $R_L=3\Omega$, $F_{in}=1kHz$		2.9		W
		THD=10%, $R_L=4\Omega$, $F_{in}=1kHz$		2.6		
		THD=10%, $R_L=8\Omega$, $F_{in}=1kHz$		1.6		
		THD=1%, $R_L=3\Omega$, $F_{in}=1kHz$		2.4		
		THD=1%, $R_L=4\Omega$, $F_{in}=1kHz$		1.8		
		THD=0.5%, $R_L=8\Omega$, $F_{in}=1kHz$	1	1.3		
THD+N	Total Harmonic Distortion Plus Noise	$P_o=1.2W$, $R_L=4\Omega$, $F_{in}=1kHz$		0.07		%
		$P_o=0.9W$, $R_L=8\Omega$, $F_{in}=1kHz$		0.08		
PSRR	Power Ripple Rejection Ratio	$V_{IN}=0.1V_{rms}$, $R_L=8\Omega$, $C_B=1\mu F$, $F_{in}=120Hz$		60		dB
Xtalk	Channel Separation	$C_B=1\mu F$, $R_L=8\Omega$, $F_{in}=1kHz$		90		dB
S/N	Signal to Noise Ratio	$P_o=1.1W$, $R_L=8\Omega$, A_wieght		95		dB

Operating Characteristics, SE mode.

$V_{DD}=5V$, $T_A=25^{\circ}C$, Gain=1V/V (unless otherwise noted)

Symbol	Parameter	Test Condition	APA2069			Unit
			Min.	Typ.	Max.	
P_o	Maximum Output Power	THD=10%, $R_L=16\Omega$, $F_{in}=1kHz$		220		mW
		THD=10%, $R_L=32\Omega$, $F_{in}=1kHz$		120		
		THD=1%, $R_L=16\Omega$, $F_{in}=1kHz$		160		
		THD=1%, $R_L=32\Omega$, $F_{in}=1kHz$		95		

Electrical Characteristics (Cont.)

Operating Characteristics, SE mode.

$V_{DD}=5V, T_A=25^{\circ}C, \text{Gain}=1V/V$ (unless otherwise noted)

Symbol	Parameter	Test Condition	APA2069			Unit
			Min.	Typ.	Max.	
THD+N	Total Harmonic Distortion Plus Noise	$P_o=125mW, R_L=16\Omega, F_{in}=1kHz$		0.09		%
		$P_o=65mW, R_L=32\Omega, F_{in}=1kHz$		0.09		
PSRR	Power Ripple Rejection Ratio	$V_{IN}=0.1V_{rms}, R_L=8\Omega, C_B=1\mu F, F_{in}=120Hz$		60		dB
Xtalk	Channel Separation	$C_B=1\mu F, R_L=32\Omega, F_{in}=1kHz$		60		dB
S/N	Signal to Noise Ratio	$P_o=75mW, SE, R_L=32\Omega, A_{weight}$		100		dB

Pin Description

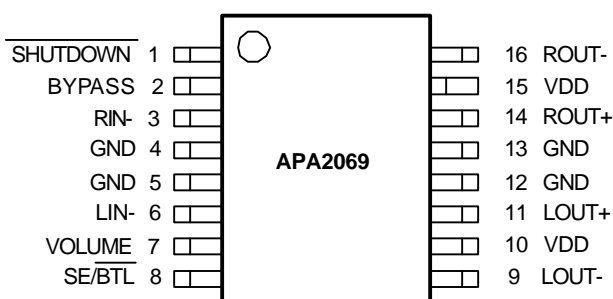

Pin Function Description

Pin		Config	Function Description
No.	Name		
1	SHUTDOWN	I	It will be into shutdown mode when pull low. $I_{SD} = 1\mu A$
2	BYPASS	I	Bias voltage generator
3	RIN-	I	Right channel input terminal
4,5,12,13	GND	-	Ground connection, Connected to thermal pad.
6	LIN-	I	Left channel input terminal
7	VOLUME	I	Input signal for internal volume gain setting.
8	SE/BTL	I	Output mode control input, high for SE output mode and low for BTL mode.
9	LOUT-	O	Left channel positive output in BTL mode and SE mode.
10,15	VDD	-	Supply voltage
11	LOUT+	O	Left channel negative output in BTL mode and high impedance in SE mode.
14	ROUT+	O	Right channel negative output in BTL mode and high impedance in SE mode.
16	ROUT-	O	Right channel positive output in BTL mode and SE mode.

Typical Application Circuit

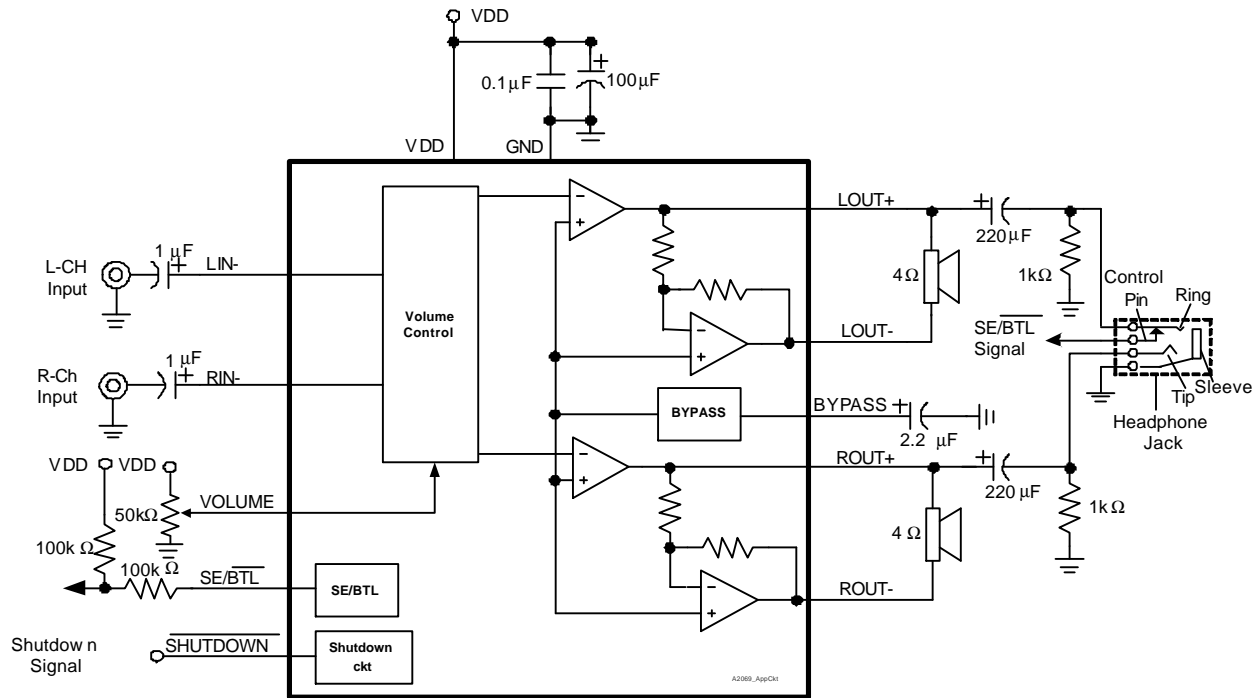

Volume Control Table_BTL Mode

Supply Voltage Vdd=5V

Gain(dB)	High(V)	Low(V)	Hysteresis(mV)	Recommended Voltage(V)
20	0.12	0.00		0
18	0.23	0.17	52	0.20
16	0.34	0.28	51	0.31
14	0.46	0.39	50	0.43
12	0.57	0.51	49	0.54
10	0.69	0.62	47	0.65
8	0.80	0.73	46	0.77
6	0.91	0.84	45	0.88
4	1.03	0.96	44	0.99
2	1.14	1.07	43	1.10
0	1.25	1.18	41	1.22
-2	1.37	1.29	40	1.33
-4	1.48	1.41	39	1.44
-6	1.59	1.52	38	1.56
-8	1.71	1.63	37	1.67

Volume Control Table_BTL Mode (Cont.)

Supply Voltage Vdd=5V

Gain(dB)	High(V)	Low(V)	Hysteresis(mV)	Recommended Voltage(V)
-10	1.82	1.74	35	1.78
-12	1.93	1.85	34	1.89
-14	2.05	1.97	33	2.01
-16	2.16	2.08	32	2.12
-18	2.28	2.19	30	2.23
-20	2.39	2.30	29	2.35
-22	2.50	2.42	28	2.46
-24	2.62	2.53	27	2.57
-26	2.73	2.64	26	2.69
-28	2.84	2.75	24	2.80
-30	2.96	2.87	23	2.91
-32	3.07	2.98	22	3.02
-34	3.18	3.09	21	3.14
-36	3.30	3.20	20	3.25
-38	3.41	3.32	18	3.36
-40	3.52	3.43	17	3.48
-80	5.00	3.54	16	5

Typical Characteristics

THD+N vs. Output Power

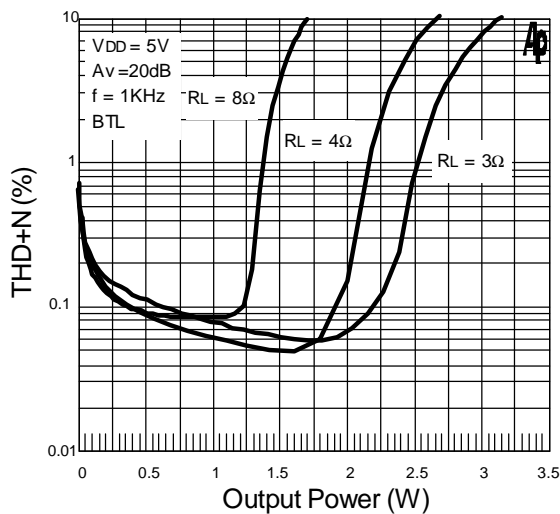

THD+N vs. Output Power

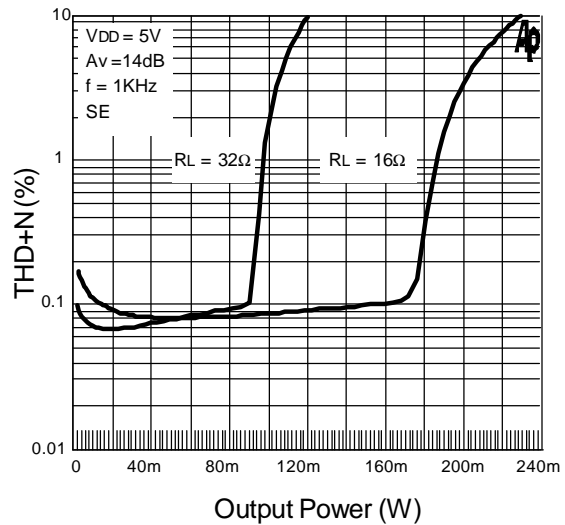

Typical Characteristics (Cont.)

THD+N vs. Output Power

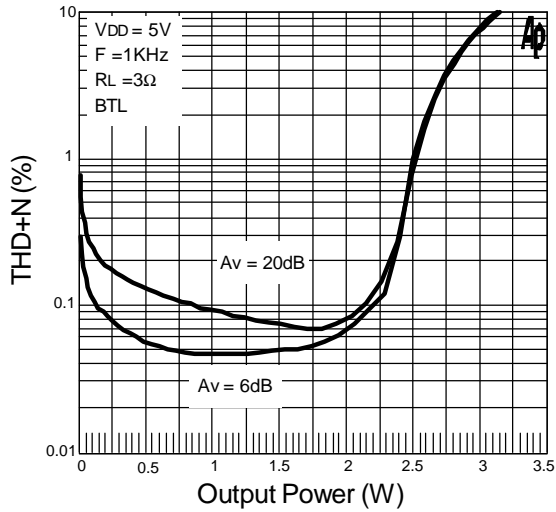

THD+N vs. Output Power

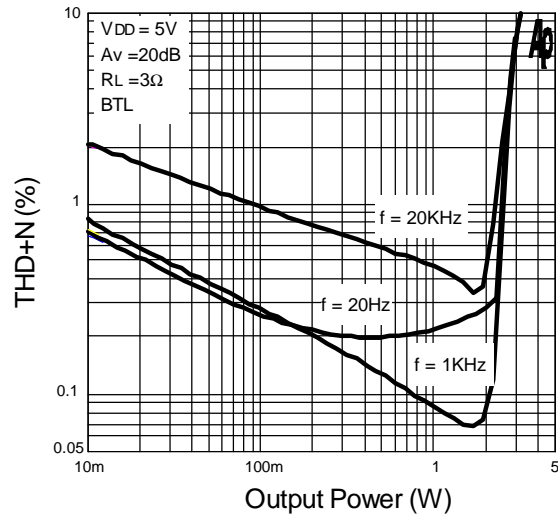

THD+N vs. Frequency

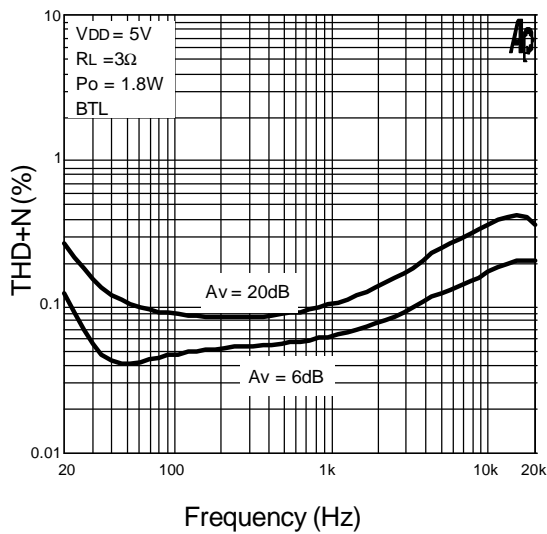

THD+N vs. Frequency

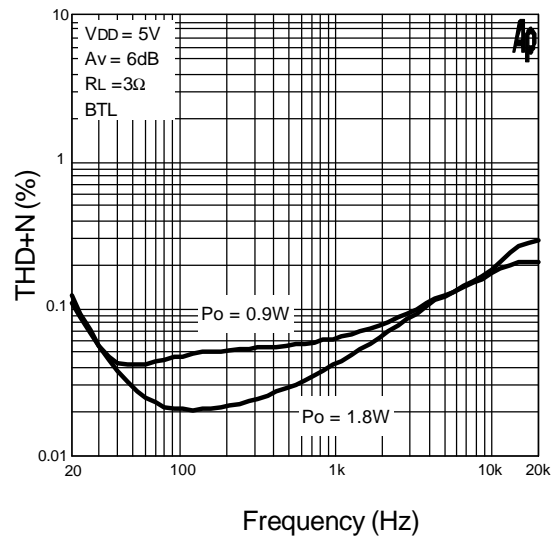

Typical Characteristics (Cont.)

THD+N vs. Output Power

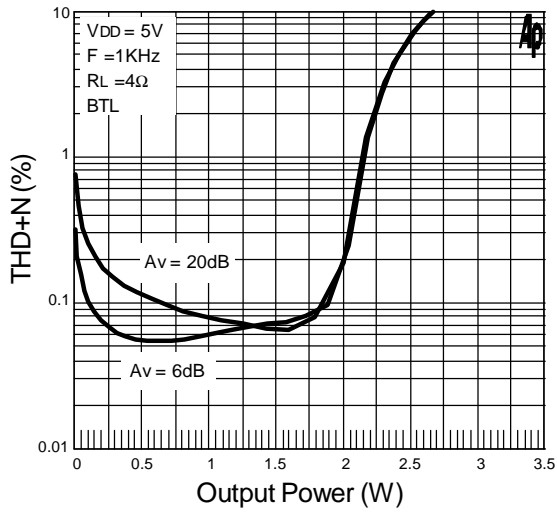

THD+N vs. Output Power

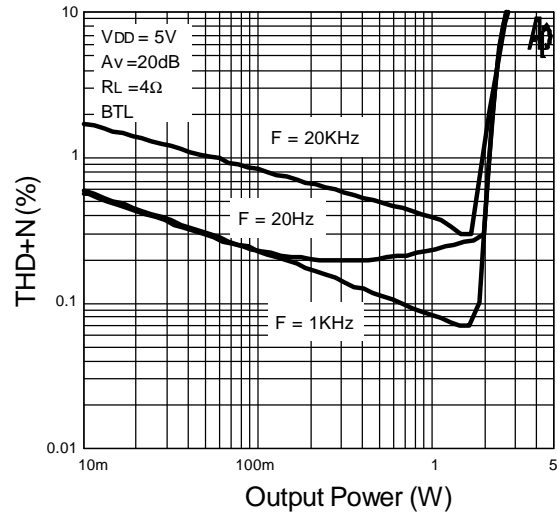

THD+N vs. Frequency

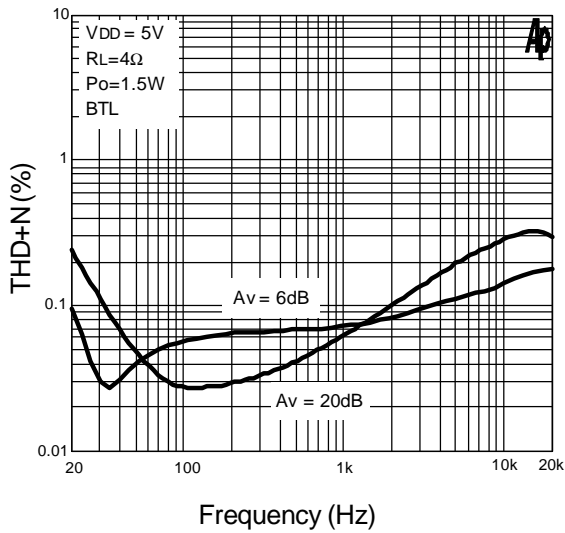

THD+N vs. Frequency

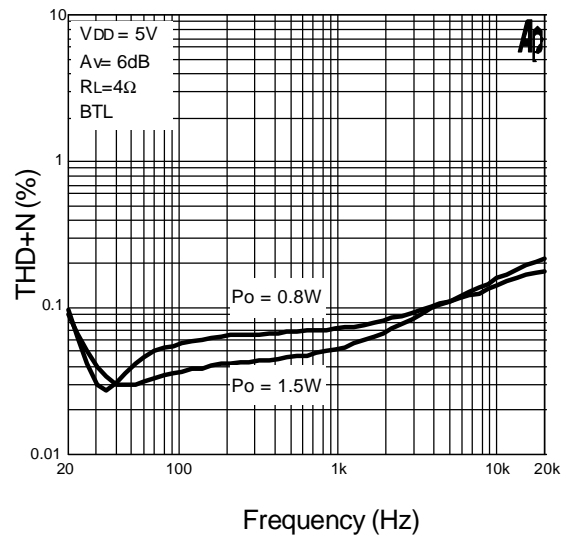

Typical Characteristics (Cont.)

THD+N vs. Output Power

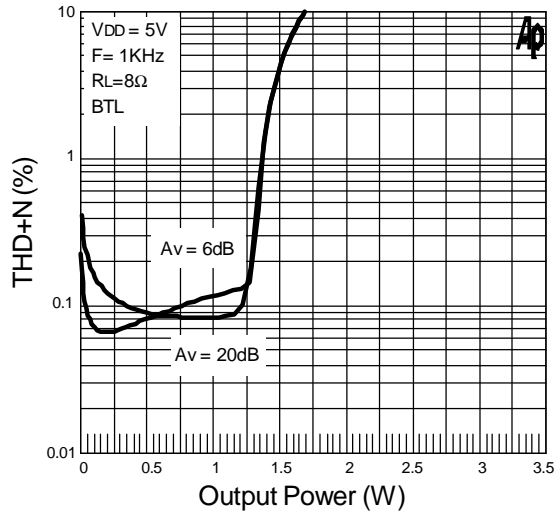

THD+N vs. Output Power

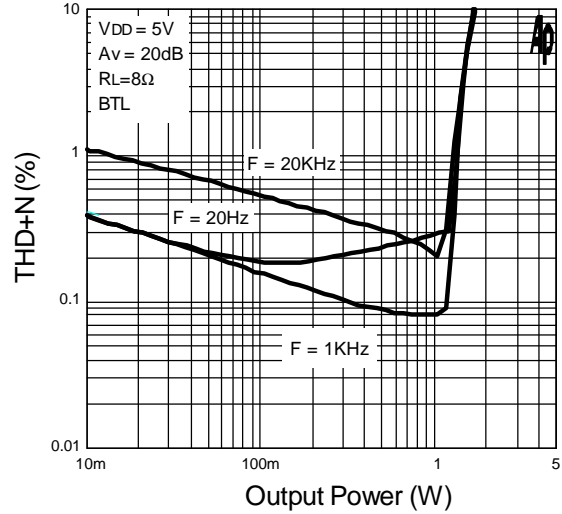

THD+N vs. Frequency

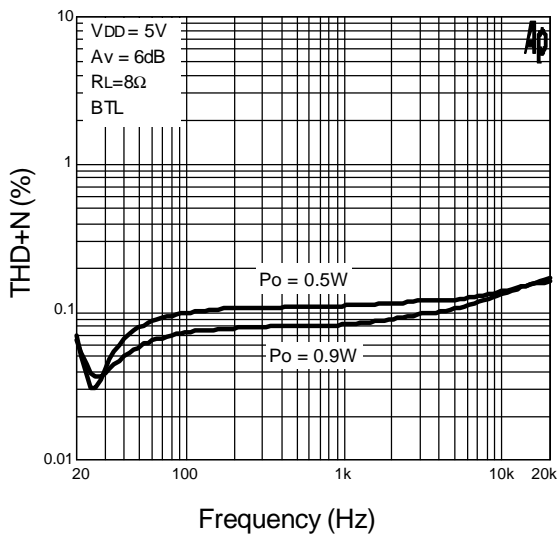

THD+N vs. Frequency

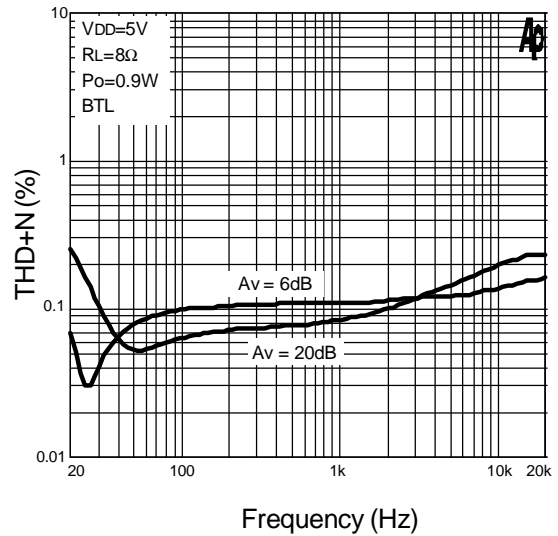

Typical Characteristics (Cont.)

THD+N vs. Output Power

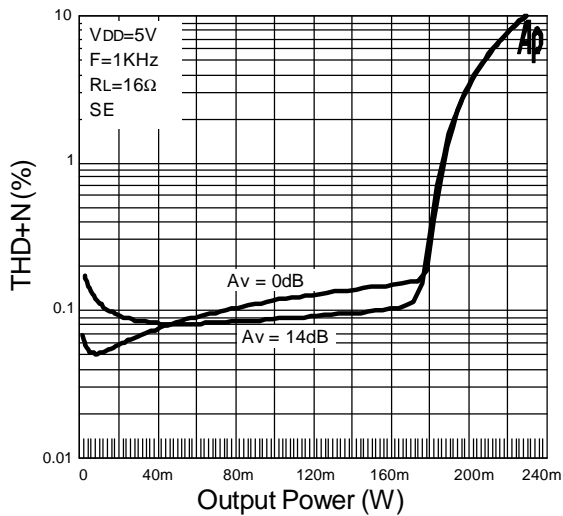

THD+N vs. Output Power

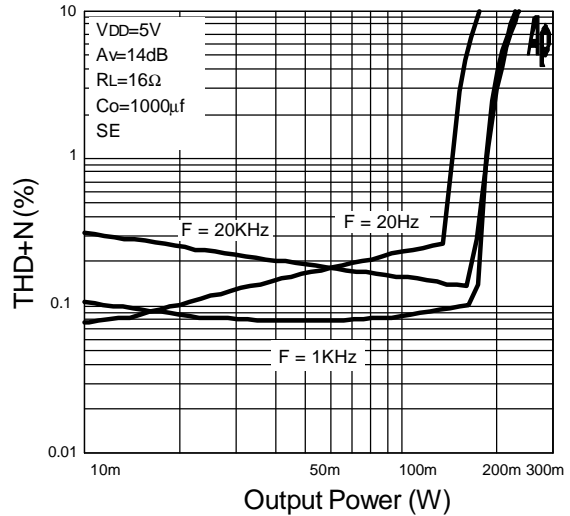

THD+N vs. Frequency

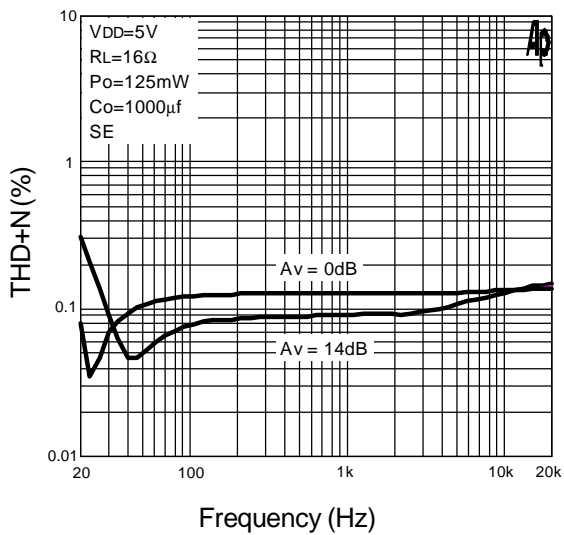

THD+N vs. Frequency

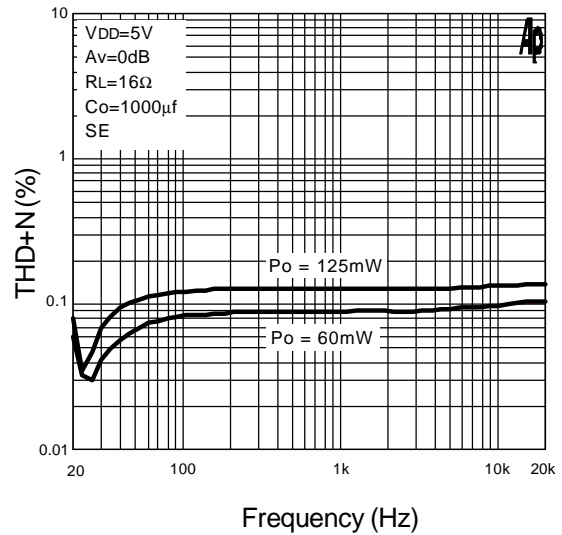

Typical Characteristics (Cont.)

THD+N vs. Output Power

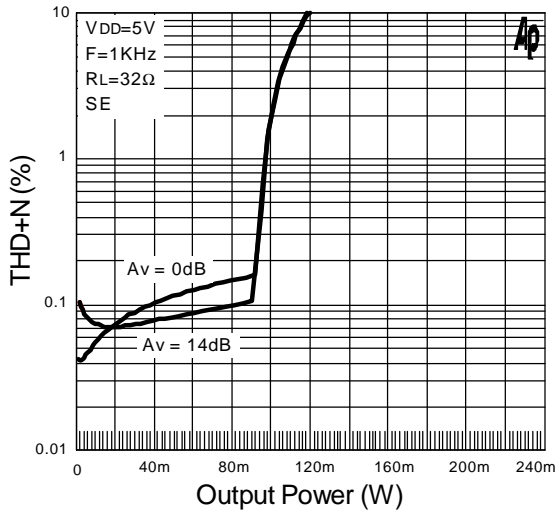

THD+N vs. Output Power

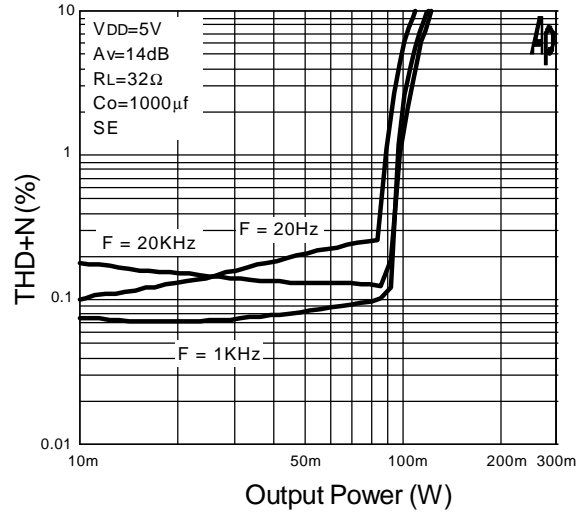

THD+N vs. Frequency

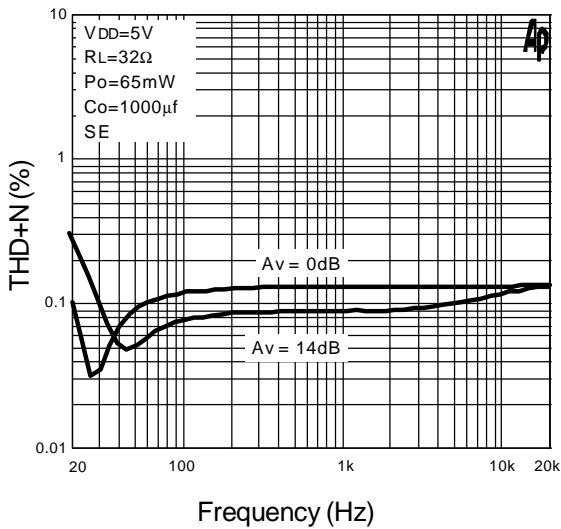

THD+N vs. Frequency

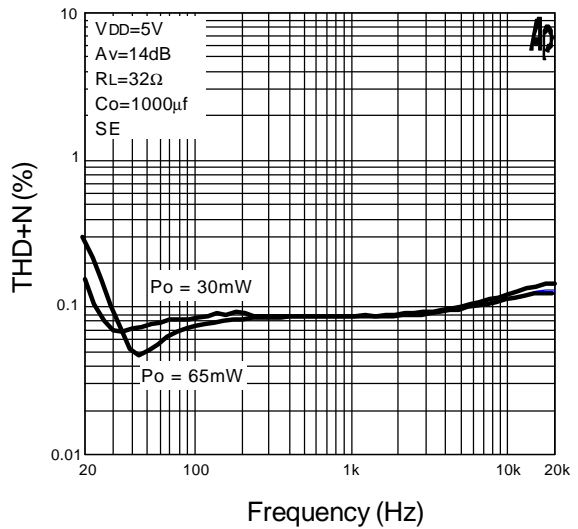

Typical Characteristics (Cont.)

Frequency Response

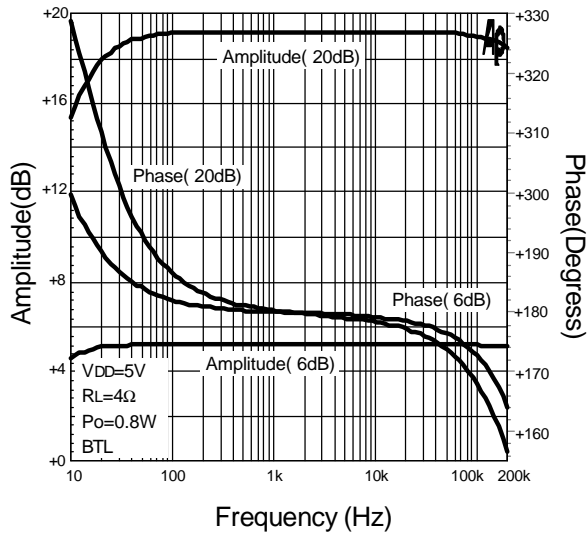

Frequency Response

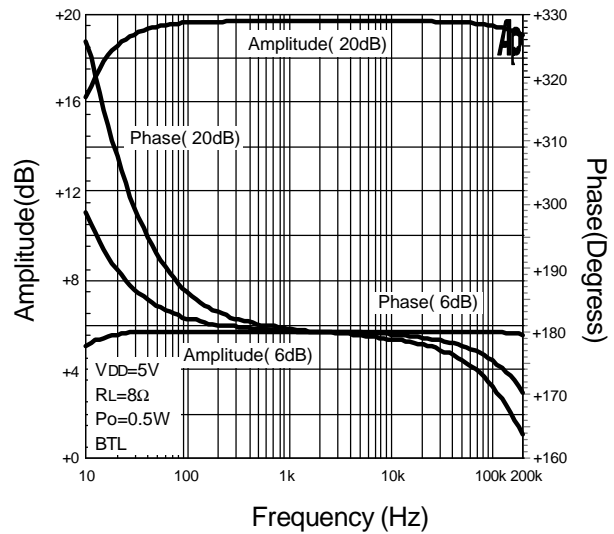

Frequency Response

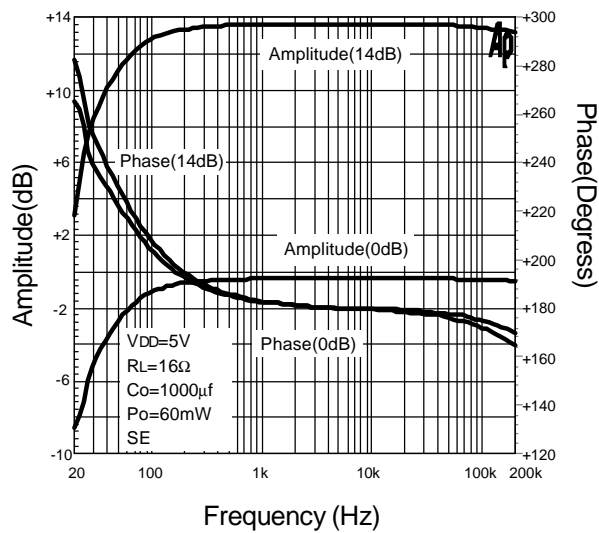

Frequency Response

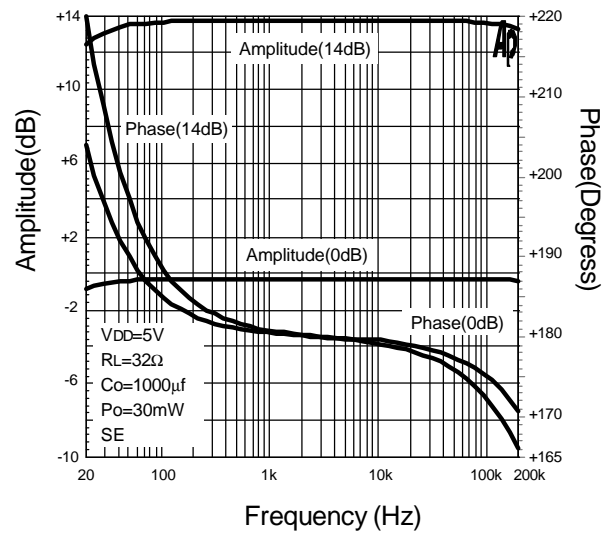

Typical Characteristics (Cont.)

Crosstalk vs. Frequency

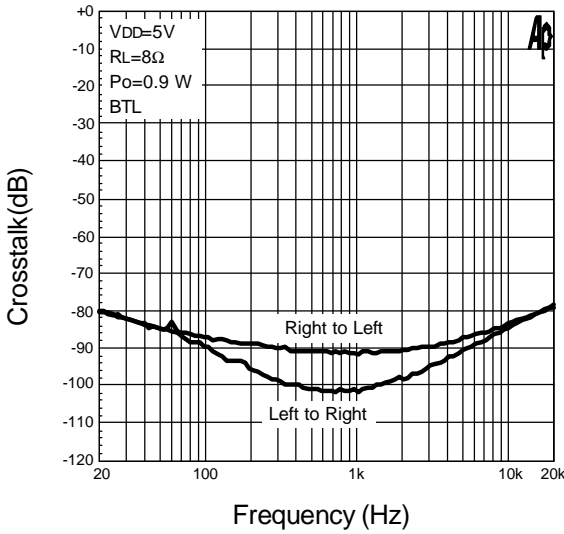

Crosstalk vs. Frequency

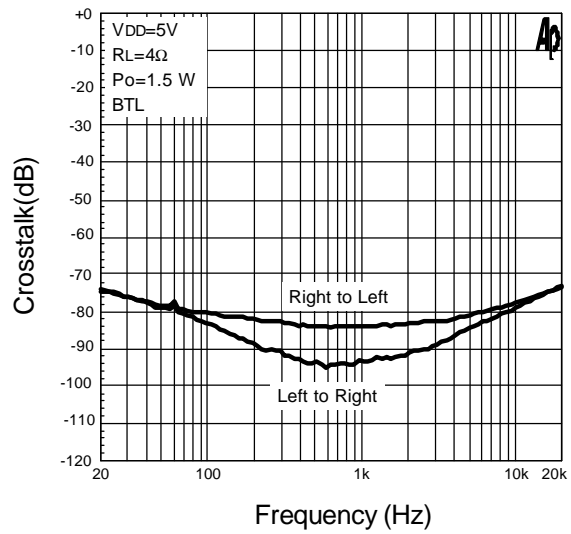

Crosstalk vs. Frequency

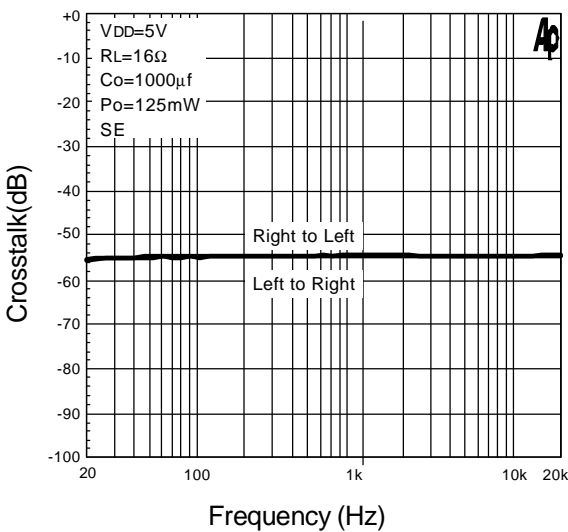

Crosstalk vs. Frequency

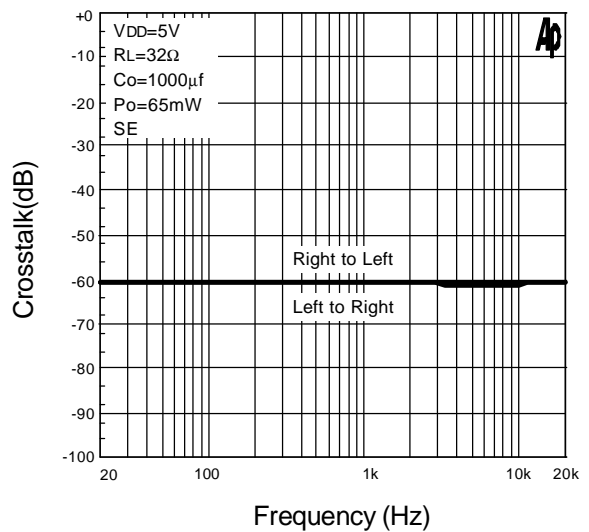

Typical Characteristics (Cont.)

Output Noise Voltage vs. Frequency

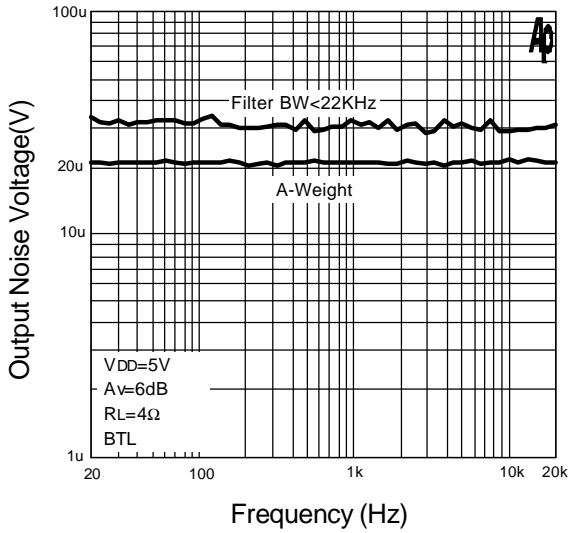

Output Noise Voltage vs. Frequency

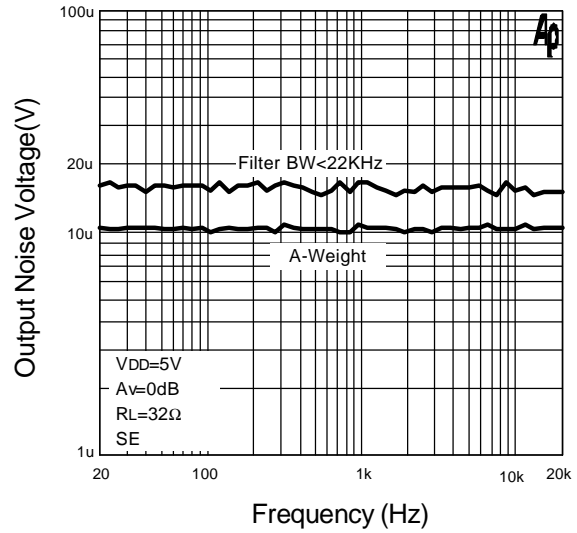

PSRR vs. Frequency

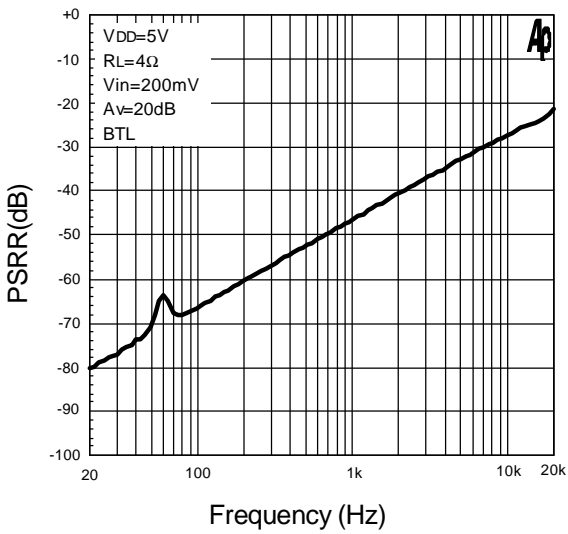

PSRR vs. Frequency

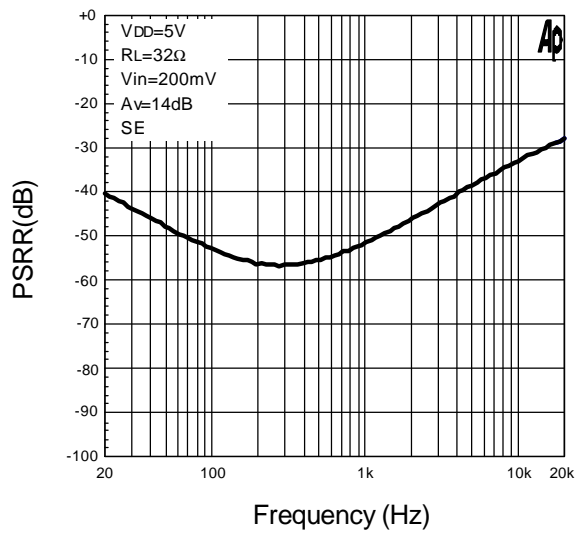

Typical Characteristics (Cont.)

Shutdown Attenuation vs. Frequency

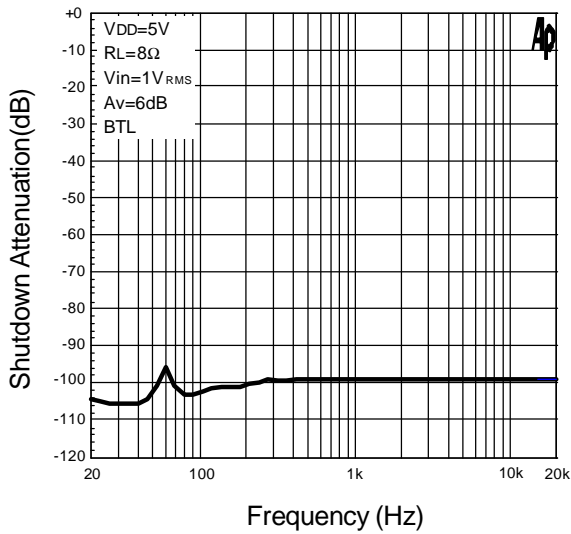

Gain vs. DC volume Voltage

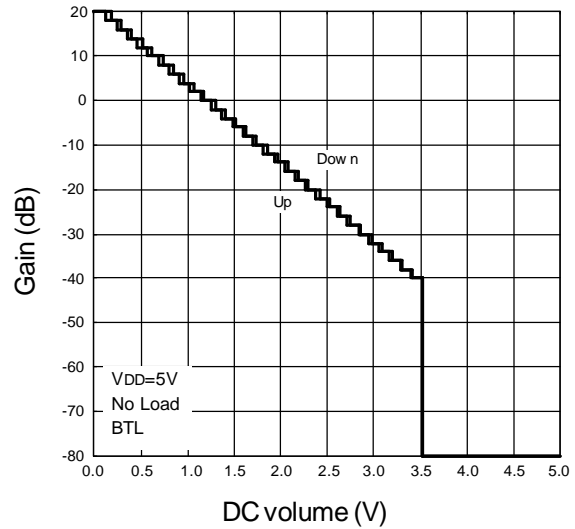

Supply Current vs. Supply Voltage

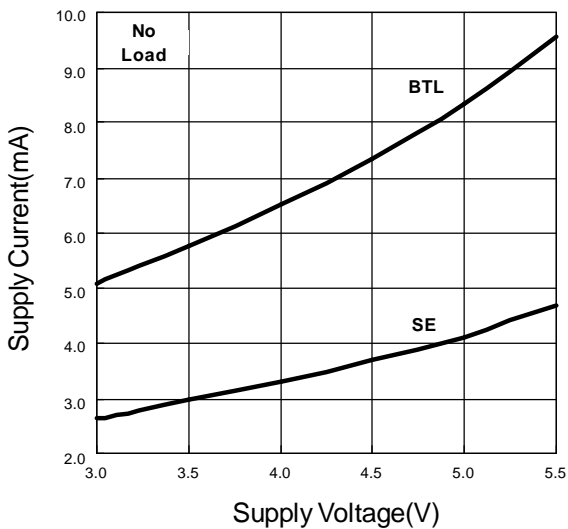

Power Dissipation vs. Output Power

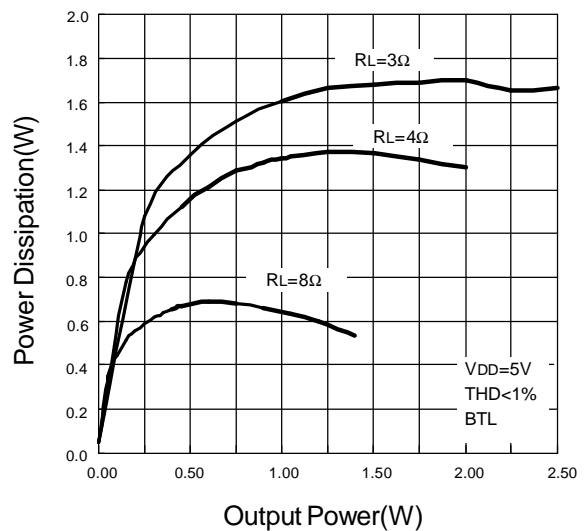

Typical Characteristics (Cont.)

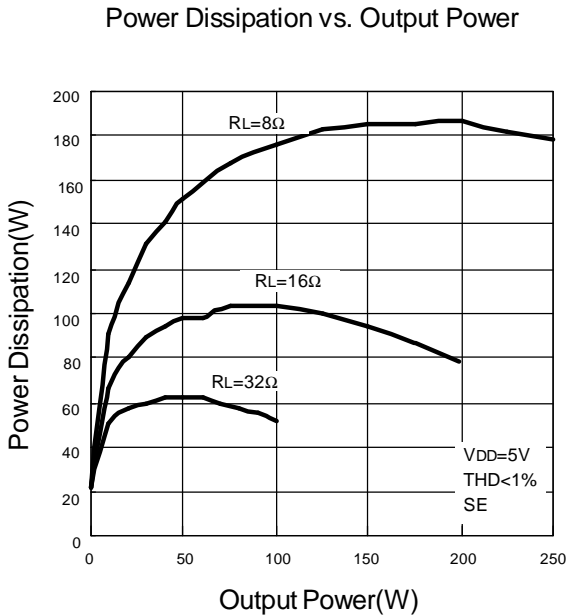

Application Descriptions

BTL Operation

The APA2069 output stage (power amplifier) has two pairs of operational amplifiers internally, allowed for different amplifier configurations.

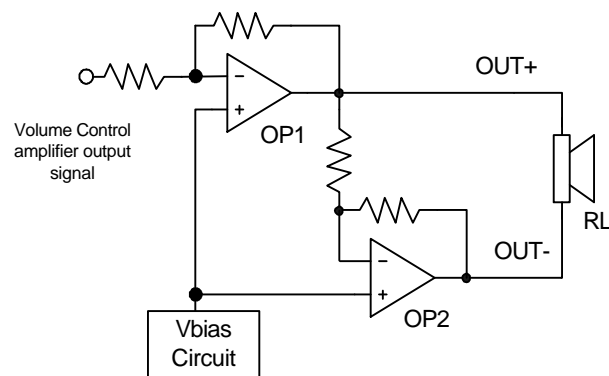

Figure 1: APA2069 internal configuration
(each channel)

The power amplifier's OP1 gain is setting by internal unity-gain and input audio signal is come from internal volume control amplifier, while the second amplifier OP2 is internally fixed in a unity-gain, inverting configuration. Figure 1 shows that the output of OP1 is connected to the input to OP2, which results in the output signals of with both amplifiers with identical in magnitude, but out of phase 180° . Consequently, the differential gain for each channel is 2 x (Gain of SE mode).

By driving the load differentially through outputs OUT+ and OUT-, an amplifier configuration commonly referred to as bridged mode is established. BTL mode operation is different from the classical single-ended SE amplifier configuration where one side of its load is connected to ground.

A BTL amplifier design has a few distinct advantages

Application Descriptions (Cont.)

BTL Operation (Cont.)

over the SE configuration, as it provides differential drive to the load, thus doubling the output swing for aspecified supply voltage.

Four times the output power is possible as compared to a SE amplifier under the same conditions. A BTL configuration, such as the one used in APA2069, also creates a second advantage over SE amplifiers. Since the differential outputs, ROUT+, ROUT-, LOU+, and LOU-, are biased at half-supply, no DC voltage exists across the load. This eliminates the need for an output coupling capacitor which is required in a single supply, SE configuration.

Single-Ended Operation

Consider the single-supply SE configuration shown Application Circuit. A coupling capacitor is required to block the DC offset voltage from reaching the load. These capacitors can be quite large (approximately 33µF to 1000µF) so they tend to be expensive, occupy valuable PCB area, and have the additional drawback of limiting low-frequency performance of the system (refer to the Output Coupling Capacitor). The rules described still hold with the addition of the following relationship:

$$\frac{1}{C_{bypass} \times 125k\Omega} \leq \frac{1}{R_i C_i} \ll \frac{1}{R_L C_c} \quad (1)$$

Output SE/BTL Operation

The ability of the APA2069 to easily switch between BTL and SE modes is one of its most important cost saving features. This feature eliminates the requirement for an additional headphone amplifier in applications where internal stereo speakers are driven in BTL mode but external headphone or speakers must be accommodated.

Internal to the APA2069, two separate amplifiers drive OUT+ and OUT- (see Figure 1). The SE/BTL input

controls the operation of the follower amplifier that drives LOU+ and LOU-.

- When SE/BTL is held low, the OP2 is turned on and the APA2069 is in the BTL mode.
- When SE/BTL is held high, the OP2 is in a high output impedance state, which configures the APA2069 as SE driver from OUT+. I_{DD} is reduced by approximately one-half in SE mode.

Control of the SE/BTL input can be a logic-level TTL source or a resistor divider network or the stereo headphone jack with switch pin as shown in Application Circuit.

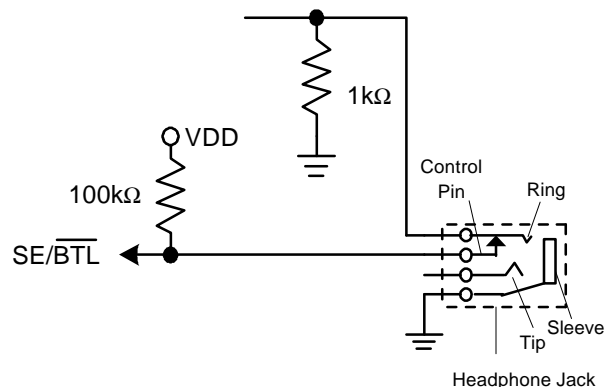

Figure 2: SE/BTL input selection by phonejack plug

In Figure 2, input SE/BTL operates as follows: When the phonejack plug is inserted, the 1kΩ resistor is disconnected and the SE/BTL input is pulled high and enables the SE mode. When the input goes high, the OUT- amplifier is shutdown causing the speaker to mute. The OUT+ amplifier then drives through the output capacitor (C_o) into the headphone jack. When there is no headphone plugged into the system, the contact pin of the headphone jack is connected from the signal pin, the voltage divider set up by resistors 100kΩ and 1kΩ. Resistor 1kΩ then pulls low the SE/BTL pin, enabling the BTL function.

Application Descriptions (Cont.)

Volume Control Function

APA2069 has an internal stereo volume control whose setting is a function of the DC voltage applied to the VOLUME input pin. The APA2069 volume control consists of 32 steps that are individually selected by a variable DC voltage level on the VOLUME control pin. The range of the steps, controlled by the DC voltage, are from 20dB to -80dB. Each gain step corresponds to a specific input voltage range, as shown in table. To minimize the effect of noise on the volume control pin, which can affect the selected gain level, hysteresis and clock delay are implemented. The amount of hysteresis corresponds to half of the step width, as shown in volume control graph.

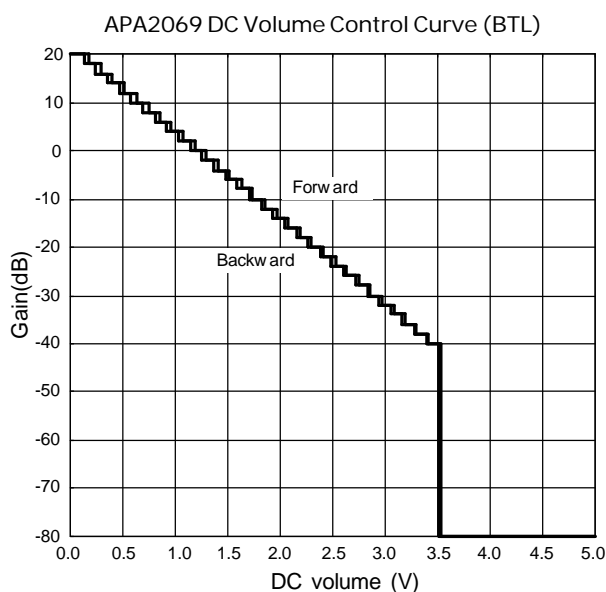

Figure 3: Gain setting vs VOLUME pin voltage

For highest accuracy, the voltage shown in the 'recommended voltage' column of the table is used to select a desired gain. This recommended voltage is exactly halfway between the two nearest transitions. The gain levels are 2dB/step from 20dB to -40dB in BTL mode, and the last step at -80dB as mute mode.

Input Resistance, Ri

The gain for each audio input of the APA2069 is set by the internal resistors (R_i and R_f) of volume control amplifier in inverting configuration.

$$SE \text{ Gain} = A_v = -\frac{R_f}{R_i} \quad (2)$$

$$BTL \text{ Gain} = -2 \times \frac{R_f}{R_i} \quad (3)$$

BTL mode operation brings the factor of 2 in the gain equation due to the inverting amplifier mirroring the voltage swing across the load. For the varying gain setting, APA2069 generates each input resistance on figure 4. The input resistance will affect the low frequency performance of audio signal. The minimum input resistance is 10kΩ when gain setting is 20dB and the resistance will ramp up when close loop gain below 20dB. The input resistance has wide variation (+/-10%) caused by process variation.

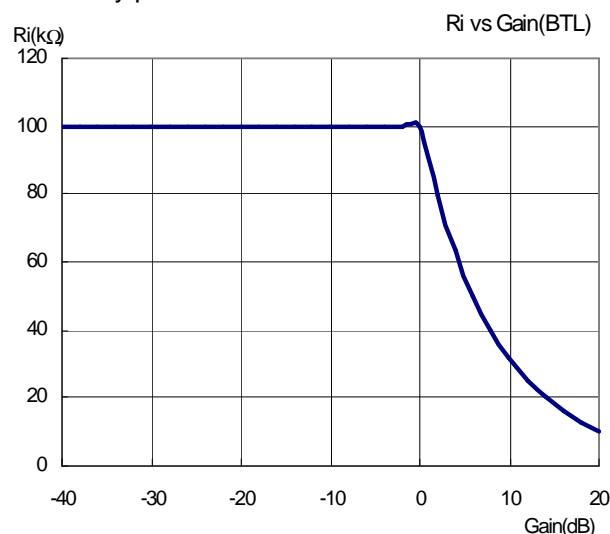

Figure 4: Input resistance vs Gain setting

Input Capacitor, Ci

In the typical application an input capacitor, C_i , is required to allow the amplifier to bias the input signal to the proper DC level for optimum operation. In this

Application Descriptions (Cont.)

Input Capacitor, Ci (Cont.)

case, Ci and the minimum input impedance Ri (10kΩ) form a high-pass filter with the corner frequency determined in the follow equation:

$$F_c(\text{highpass}) = \frac{1}{2\pi \times 10\text{k}\Omega \times C_i} \quad (4)$$

The value of Ci is important to consider as it directly affects the low frequency performance of the circuit. Consider the example where Ri is 10kΩ and the specification calls for a flat bass response down to 100Hz. Equation is reconfigured as follow :

$$C_i = \frac{1}{2\pi \times 10\text{k}\Omega \times f_c} \quad (5)$$

Consider to input resistance variation, the Ci is 0.16μF so one would likely choose a value in the range A further consideration for this capacitor is the leakage path from the input source through the input network (Ri+Rf, Ci) to the load. This leakage current creates a DC offset voltage at the input to the amplifier that reduces useful headroom, especially in high gain applications. For this reason a low-leakage tantalum or ceramic capacitor is the best choice. When polarized capacitors are used, the positive side of the capacitor should face the amplifier input in most applications as the DC level there is held at $V_{DD}/2$, which is likely higher than the source DC level. Please note that it is important to confirm the capacitor polarity in the application.

Effective Bypass Capacitor, Cbypass

As other power amplifiers, proper supply bypassing is critical for low noise performance and high power supply rejection.

The capacitors located on both the bypass and power supply pins should be as close to the device as possible. The effect of a larger bypass capacitor will improve PSRR due to increased supply stability. Typical applications employ a 5V regulator with 1.0μF and a 0.1μF bypass capacitor as supply filtering. This

does not eliminate the need for bypassing the supply nodes of the APA2069. The selection of bypass capacitors, especially Cbypass, is thus dependent upon desired PSRR requirements, click and pop performance.

To avoid start-up pop noise occurred, the bypass voltage should rise slower than the input bias voltage and the relationship shown in equation (6) should be maintained.

$$\frac{1}{C_{\text{bypass}} \times 125\text{k}\Omega} \ll \frac{1}{100\text{k}\Omega \times C_i} \quad (6)$$

The bypass capacitor is fed thru from a 125kΩ resistor inside the amplifier and the 100kΩ is maximum input resistance of (Ri+ Rf). Bypass capacitor, Cb, values of 3.3μF to 10μF ceramic or tantalum low-ESR capacitors are recommended for the best THD and noise performance.

The bypass capacitance also effects to the start up time. It is determined in the following equation :

$$T_{\text{start up}} = 5 \times (C_{\text{bypass}} \times 125\text{k}\Omega) \quad (7)$$

Output Coupling Capacitor, Cc

In the typical single-supply SE configuration, an output coupling capacitor (Cc) is required to block the DC bias at the output of the amplifier thus preventing DC currents in the load. As with the input coupling capacitor, the output coupling capacitor and impedance of the load form a high-pass filter governed by equation.

$$F_c(\text{highpass}) = \frac{1}{2\pi R_L C_c} \quad (8)$$

For example, a 330μF capacitor with an 8Ω speaker would attenuate low frequencies below 60.6Hz. The main disadvantage, from a performance standpoint, is the load impedance is typically small, which drives the low-frequency corner higher degrading the bass response. Large values of Cc are required to pass low frequencies into the load.

Application Descriptions (Cont.)

Power Supply Decoupling, Cs

The APA2069 is a high-performance CMOS audio amplifier that requires adequate power supply decoupling to ensure the output total harmonic distortion (THD) is as low as possible. Power supply decoupling also prevents the oscillations causing by long lead length between the amplifier and the speaker. The optimum decoupling is achieved by using two different type capacitors that target on different type of noise on the power supply leads.

For higher frequency transients, spikes, or digital hash on the line, a good low equivalent-series-resistance (ESR) ceramic capacitor, typically 0.1 μ F placed as close as possible to the device V_{DD} lead works best. For filtering lower-frequency noise signals, a large aluminum electrolytic capacitor of 10 μ F or greater placed near the audio power amplifier is recommended.

Optimizing Depop Circuitry

Circuitry has been included in the APA2069 to minimize the amount of popping noise at power-up and when coming out of shutdown mode. Popping occurs whenever a voltage step is applied to the speaker. In order to eliminate clicks and pops, all capacitors must be fully discharged before turn-on. Rapid on/off switching of the device or the shutdown function will cause the click and pop circuitry.

The value of C_i will also affect turn-on pops (Refer to Effective Bypass Capacitance). The bypass voltage ramp up should be slower than input bias voltage. Although the bypass pin current source cannot be modified, the size of C_{bypass} can be changed to alter the device turn-on time and the amount of clicks and pops. By increasing the value of C_{bypass} , turn-on pop can be reduced. However, the tradeoff for using a larger bypass capacitor is to increase the turn-on time for this device. There is a linear relationship between the

size of C_{bypass} and the turn-on time. In a SE configuration, the output coupling capacitor, C_c , is of particular concern.

This capacitor discharges through the internal 10k Ω resistors. Depending on the size of C_c , the time constant can be relatively large. To reduce transients in SE mode, an external 1k Ω resistor can be placed in parallel with the internal 10k Ω resistor. The tradeoff for using this resistor is an increase in quiescent current. In the most cases, choosing a small value of C_i in the range of 0.33 μ F to 1 μ F, C_b being equal to 4.7 μ F and an external 1k Ω resistor should be placed in parallel with the internal 10k Ω resistor should produce a virtually clickless and popless turn-on.

A high gain amplifier intensifies the problem as the small delta in voltage is multiplied by the gain. So it is advantageous to use low-gain configurations.

Shutdown Function

In order to reduce power consumption while not in use, the APA2069 contains a shutdown pin to externally turn off the amplifier bias circuitry. This shutdown feature turns the amplifier off when a logic low is placed on the SHUTDOWN pin. The trigger point between a logic high and logic low level is typically 2.0V. It is best to switch between ground and the supply V_{DD} to provide maximum device performance.

By switching the SHUTDOWN pin to low, the amplifier enters a low-current state, $I_{DD} < 1\mu$ A. APA2069 is in shutdown mode. On normal operating, SHUTDOWN pin pull to high level to keeping the IC out of the shutdown mode. The SHUTDOWN pin should be tied to a definite voltage to avoid unwanted state changes.

BTL Amplifier Efficiency

An easy-to-use equation to calculate efficiency starts out as being equal to the ratio of power from the power

Application Descriptions (Cont.)

BTL Amplifier Efficiency (Cont.)

supply to the power delivered to the load.

The following equations are the basis for calculating amplifier efficiency.

$$\text{Efficiency} = \frac{P_o}{P_{SUP}} \quad (9)$$

Where :

$$P_o = \frac{V_{ORMS} \times V_{ORMS}}{R_L} = \frac{V_p \times V_p}{2R_L}$$

$$V_{ORMS} = \frac{V_p}{\sqrt{2}} \quad (10)$$

$$P_{SUP} = V_{DD} \times I_{DDAVG} = V_{DD} \times \frac{2V_p}{\pi R_L} \quad (11)$$

Efficiency of a BTL configuration :

$$\frac{P_o}{P_{SUP}} = \left(\frac{V_p \times V_p}{2R_L} \right) / \left(V_{DD} \times \frac{2V_p}{\pi R_L} \right) = \frac{\pi V_p}{4V_{DD}} \quad (12)$$

Table 1 calculates efficiencies for four different output power levels.

Note that the efficiency of the amplifier is quite low for lower power levels and rises sharply as power to the load is increased resulting in a nearly flat internal power dissipation over the normal operating range.

Note that the efficiency of the amplifier is quite low for lower power levels and rises sharply as power to the load is increased resulting in a nearly flat internal power dissipation over the normal operating range. Note that the internal dissipation at full output power is less than in the half power range. Calculating the efficiency for a specific system is the key to proper power supply design. For a stereo 1W audio system with 8Ω loads and a 5V supply, the maximum draw on the power supply is almost 3W.

A final point to remember about linear amplifiers (either SE or BTL) is how to manipulate the terms in the efficiency equation to utmost advantage when possible.

Note that in equation, V_{DD} is in the denominator. This indicates that as V_{DD} goes down, efficiency goes up. In other words, use the efficiency analysis to choose the correct supply voltage and speaker impedance for the application.

Po (W)	Efficiency (%)	I _{DD} (A)	V _{PP} (V)	P _D (W)
0.25	31.25	0.16	2.00	0.55
0.50	47.62	0.21	2.83	0.55
1.00	66.67	0.30	4.00	0.5
1.25	78.13	0.32	4.47	0.35

**High peak voltages cause the THD to increase.

Table 1. Efficiency Vs Output Power in 5-V/8Ω BTL Systems

Power Dissipation

Whether the power amplifier is operated in BTL or SE modes, power dissipation is a major concern. In equation 13 states the maximum power dissipation point for a SE mode operating at a given supply voltage and driving a specified load.

$$\text{SE mode : } P_{D,MAX} = \frac{V_{DD}^2}{2\pi^2 R_L} \quad (13)$$

In BTL mode operation, the output voltage swing is doubled as in SE mode. Thus the maximum power dissipation point for a BTL mode operating at the same given conditions is 4 times as in SE mode.

$$\text{BTL mode : } P_{D,MAX} = \frac{4V_{DD}^2}{2\pi^2 R_L} \quad (14)$$

Since the APA2069 is a dual channel power amplifier, the maximum internal power dissipation is 2 times that both of equations depending on the mode of operation. Even with this substantial increase in power dissipation, the APA2069 does not require extra heatsink. The power dissipation from equation 14, assuming a 5V-power supply and an 8Ω load, must not

Application Descriptions (Cont.)

BTL Amplifier Efficiency (Cont.)

be greater than the power dissipation that results from the equation15 :

$$P_{D,MAX} = \frac{T_{J,MAX} - T_A}{\theta_{JA}} \quad (15)$$

For PDIP16 package with thermal pad, the thermal resistance (θ_{JA}) is equal to 45°C/W.

Since the maximum junction temperature ($T_{J,MAX}$) of APA2069 is 150°C and the ambient temperature (T_A) is defined by the power system design, the maximum power dissipation which the IC package is able to handle can be obtained from equation15.

Once the power dissipation is greater than the maximum limit ($P_{D,MAX}$), either the supply voltage (V_{DD}) must be decreased, the load impedance (R_L) must be increased or the ambient temperature should be reduced.

Thermal Considerations

Linear power amplifiers dissipate a significant amount of heat in the package under normal operating conditions.

To calculate maximum ambient temperatures, first consideration is that the numbers from the **Power Dissipation vs. Output Power** graphs are per channel values, so the dissipation of the IC heat needs to be doubled for two-channel operation. Given θ_{JA} , the maximum allowable junction temperature (T_{JMAX}), and the total internal dissipation (P_D), the maximum ambient temperature can be calculated with the following equation. The maximum recommended junction temperature for the APA2069 is 150°C. The internal dissipation figures are taken from the **Power Dissipation vs. Output Power** graphs.

$$T_{AMax} = T_{JMax} - \theta_{JA} P_D \quad (16)$$

$$150 - 45(0.8*2) = 78^\circ\text{C}$$

The APA2069 is designed with a thermal shutdown

protection that turns the device off when the junction temperature surpasses 150°C to prevent damaging the IC.

Packaging Information

PDIP-16 pin (Reference JEDEC Registration MS-001)

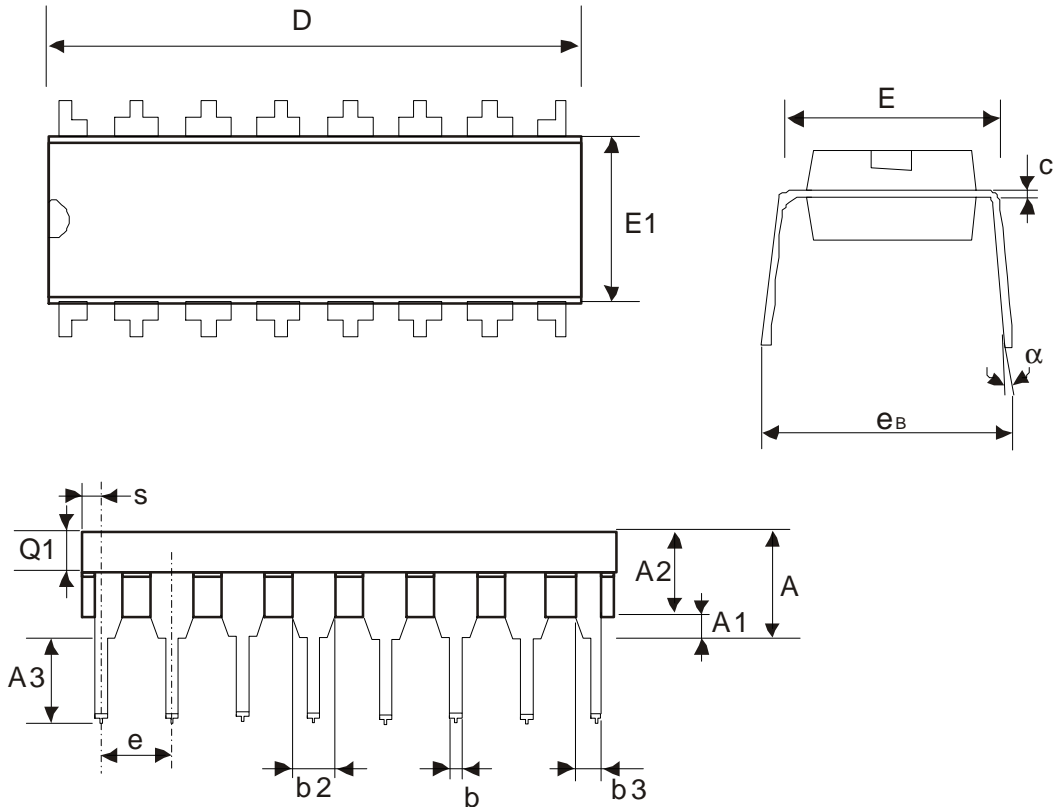

Dim	Millimeters		Inches	
	Min.	Max.	Min.	Max.
A	-	5.32	-	0.210
A1	0.38	-	0.015	-
A2	3.17	3.42	0.125	0.135
A3	2.92	3.80	0.115	0.150
b	0.36	0.56	0.014	0.022
b2	1.14	1.78	0.045	0.070
b3	0.76	1.14	0.030	0.045
c	0.20	0.36	0.008	0.014
D	18.632	19.646	0.735	0.775
E	7.605BSC		0.300BSC	
E1	6.223	6.477	0.245	0.255
e	2.54BSC		0.100BSC	
eB	8.492	9.506	0.335	0.375
Q1	1.397	1.651	0.055	0.065
s	0.58	0.84	0.023	0.033
α	3°	8°	3°	8°

Physical Specifications

Terminal Material	Solder-Plated Copper (Solder Material : 90/10 or 63/37 SnPb), 100%Sn
Lead Solderability	Meets EIA Specification RSI86-91, ANSI/J-STD-002 Category 3.

Reflow Condition (IR/Convection or VPR Reflow)

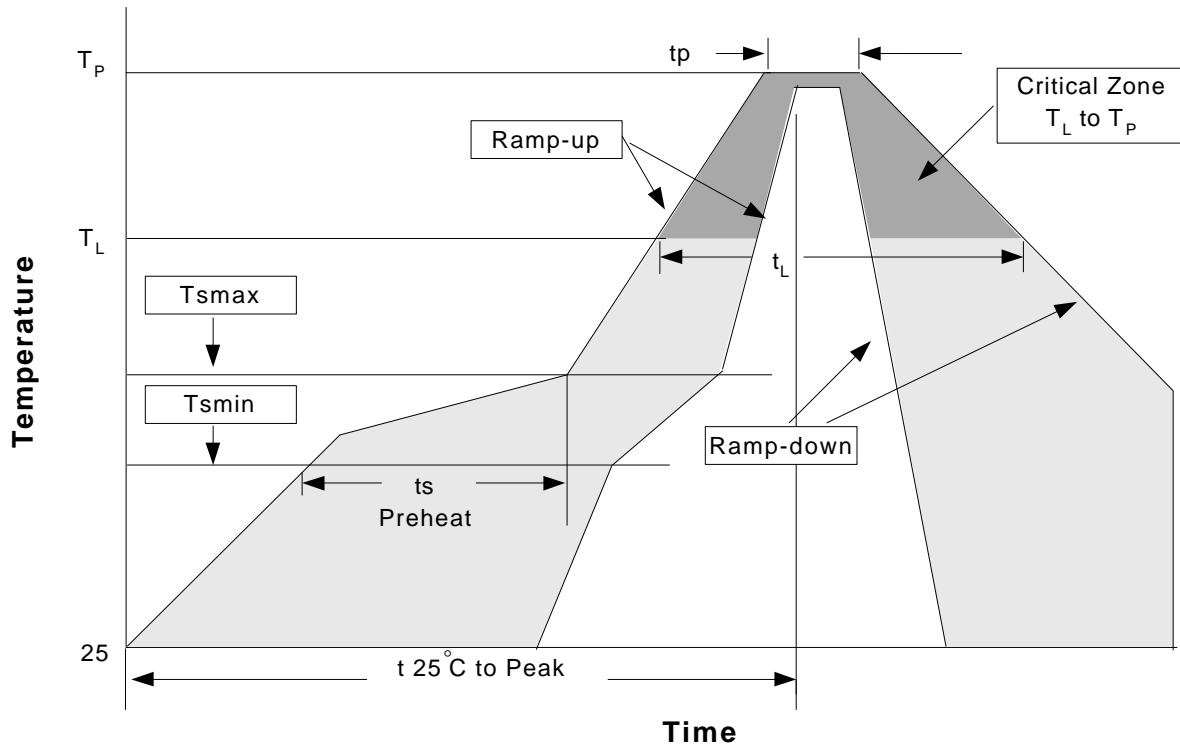

Classification Reflow Profiles

Profile Feature	Sn-Pb Eutectic Assembly	Pb-Free Assembly
Average ramp-up rate (T_L to T_P)	3°C/second max.	3°C/second max.
Preheat		
- Temperature Min (T_{smin})	100°C	150°C
- Temperature Max (T_{smax})	150°C	200°C
- Time (min to max) (t_s)	60-120 seconds	60-180 seconds
Time maintained above:		
- Temperature (T_L)	183°C	217°C
- Time (t_L)	60-150 seconds	60-150 seconds
Peak/Classification Temperature (T_p)	See table 1	See table 2
Time within 5°C of actual Peak Temperature (t_p)	10-30 seconds	20-40 seconds
Ramp-down Rate	6°C/second max.	6°C/second max.
Time 25°C to Peak Temperature	6 minutes max.	8 minutes max.

Notes: All temperatures refer to topside of the package .Measured on the body surface.

Classification Reflow Profiles (Cont.)

Table 1. SnPb Eutectic Process – Package Peak Reflow Temperatures

Package Thickness	Volume mm ³ <350	Volume mm ³ ≥350
<2.5 mm	240 +0/-5°C	225 +0/-5°C
≥2.5 mm	225 +0/-5°C	225 +0/-5°C

Table 2. Pb-free Process – Package Classification Reflow Temperatures

Package Thickness	Volume mm ³ <350	Volume mm ³ 350-2000	Volume mm ³ >2000
<1.6 mm	260 +0°C*	260 +0°C*	260 +0°C*
1.6 mm – 2.5 mm	260 +0°C*	250 +0°C*	245 +0°C*
≥2.5 mm	250 +0°C*	245 +0°C*	245 +0°C*

*Tolerance: The device manufacturer/supplier **shall** assure process compatibility up to and including the stated classification temperature (this means Peak reflow temperature +0°C. For example 260°C+0°C) at the rated MSL level.

Reliability Test Program

Test item	Method	Description
SOLDERABILITY	MIL-STD-883D-2003	245°C, 5 SEC
HOLT	MIL-STD-883D-1005.7	1000 Hrs Bias @ 125°C
PCT	JESD-22-B,A102	168 Hrs, 100%RH, 121°C
TST	MIL-STD-883D-1011.9	-65°C~150°C, 200 Cycles
ESD	MIL-STD-883D-3015.7	VHBM > 2KV, VMM > 200V
Latch-Up	JESD 78	10ms, 1 _{tr} > 100mA

Customer Service

Anpec Electronics Corp.

Head Office :

5F, No. 2 Li-Hsin Road, SBIP,

Hsin-Chu, Taiwan, R.O.C.

Tel : 886-3-5642000

Fax : 886-3-5642050

Taipei Branch :

7F, No. 137, Lane 235, Pac Chiao Rd.,

Hsin Tien City, Taipei Hsien, Taiwan, R. O. C.

Tel : 886-2-89191368

Fax : 886-2-89191369