

## 3A Low Dropout Fast Response Positive Adjustable Regulator and Fixed 3.3V

### Features

- Fast Transient Response
- Guaranteed Dropout Voltage at Multiple Currents
- Load Regulation : 0.05% Typ.
- Line Regulation : 0.03% Typ.
- Low Dropout Voltage : 1.2V Typ. at  $I_{OUT} = 3A$
- Trimmed Current Limit : 3A Typ. at  $T_j = 125\text{ }^\circ\text{C}$
- On-Chip Thermal Limiting : 150  $^\circ\text{C}$  Typ.
- Standard 3-pin TO-220 , TO-252 and TO-263 Power Package

### Applications

- Pentium™ Processor Supplies
- PowerPC™ Supplies
- Low Voltage Logic Supplies
- Battery-Powered Circuitry
- Post Regulator for Switching Power Supply

### General Description

The APL1085 is a low dropout three-terminal adjustable regulator with 3A output current capability. In order to obtain lower dropout voltage and faster transient response, which is critical for low voltage applications, the APL1085 has been optimized. The output available voltage range of adjustable version is from 1.25~5.75V with an input supply below 7V , and the fixed 3.3V output voltage device is also available.

Current limit is trimmed to ensure specified output current and controlled short-circuit current. On-chip thermal limiting provides protection against any combination of overload that would create excessive junction temperatures.

The APL1085 is available in both the through-hole and surface mount versions of the industry standard

### Pin Description

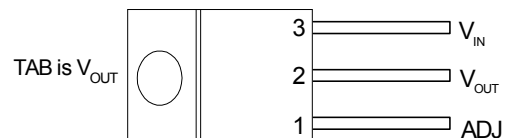

Front View APL1085 TO-220 Package

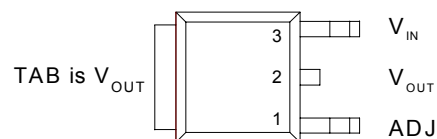

Front View APL1085 TO-252 Package

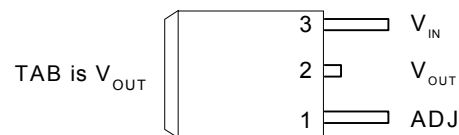

Front View APL1085 TO-263 Package

ANPEC reserves the right to make changes to improve reliability or manufacturability without notice, and advise customers to obtain the latest version of relevant information to verify before placing orders.



## Electrical Characteristics Cont.

Symbol	Parameter	Test Conditions	APL1085			Unit
			Min.	Typ.	Max.	
$\Delta I_{ADJ}$	Adjust Pin Current Change APL1085	$1.5V \leq (V_{IN} - V_{OUT}) \leq 5.75V$ , $10mA \leq I_{OUT} \leq 3A$		0.2	5	$\mu A$
$I_{LMIN}$	Minimum Load Current APL1085	$1.5V \leq (V_{IN} - V_{OUT}) \leq 5.75V$ , $T_J = 0 \sim 125^\circ C$		2	10	mA
$I_Q$	Quiescent Current APL1085-3.3	$V_{IN} = 5V$		8	13	mA
PSRR	Ripple Rejection	$F = 120Hz$ , $C_{out} = 22\mu F$ , Tant. , $(V_{IN} - V_{OUT}) = 3V$ , $I_{OUT} = 3A$	60			dB
$L_S$	Long -Term Stability	$T_J = 125^\circ C$ , 1000Hrs.		0.03	1.0	%
$V_N$	RMS Output Noise(% of $V_{OUT}$ )	$T_J = 25^\circ C$ , 10Hz? F? 10kHz		0.003		%
$\theta_{JC}$	Thermal Resistance Junction to Case	Control Circuitry/Power Transistor			0.7/3.0	$^\circ C/W$

NOTE 1: See thermal regulation specifications for changes in output voltage due to heating effects. Load and line regulations are measured at a constant junction temperature by low duty cycle pulse testing.

## Application Circuits

Typical Regulator

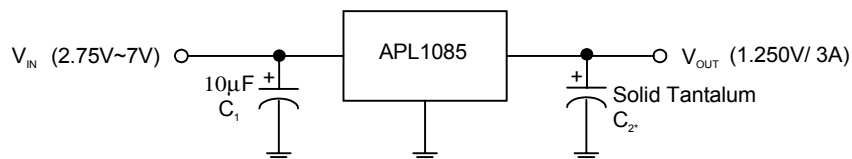

5V to 3.3V Regulator

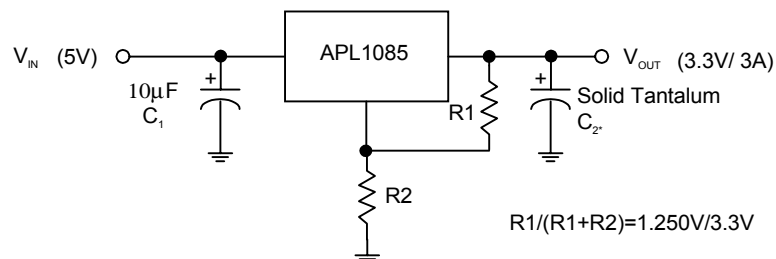

\*Required for stability

APL1085:  $C_2 = 10\mu F$

\* R1 is typically in range of 100 $\Omega$  to 120 $\Omega$

## Typical Characteristics

Dropout Voltage vs Output Current

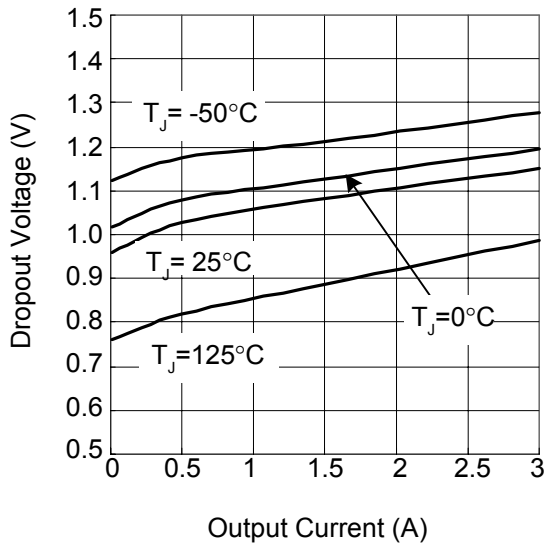

Short-Circuit Current vs Temperature

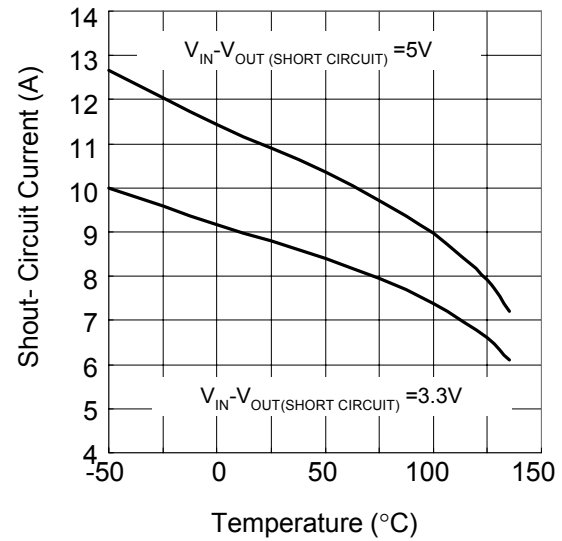

Load Regulation vs Temperature

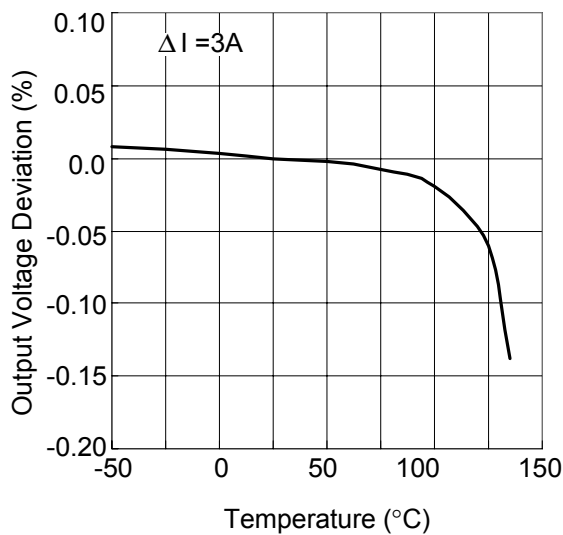

Reference Voltage vs Temperature

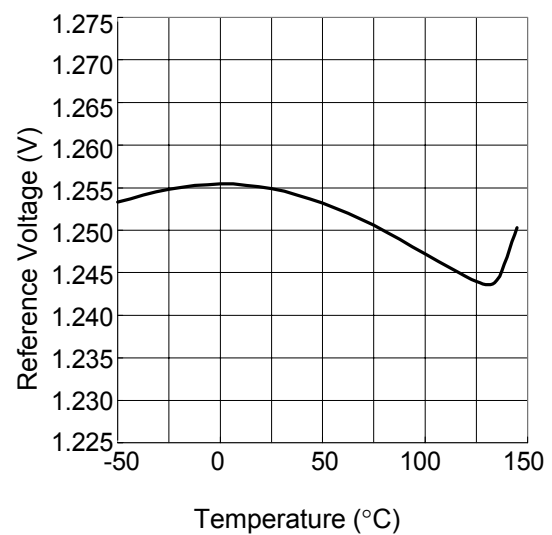

## Typical Characteristics (Cont.)

Minimum Load Current vs Temperature

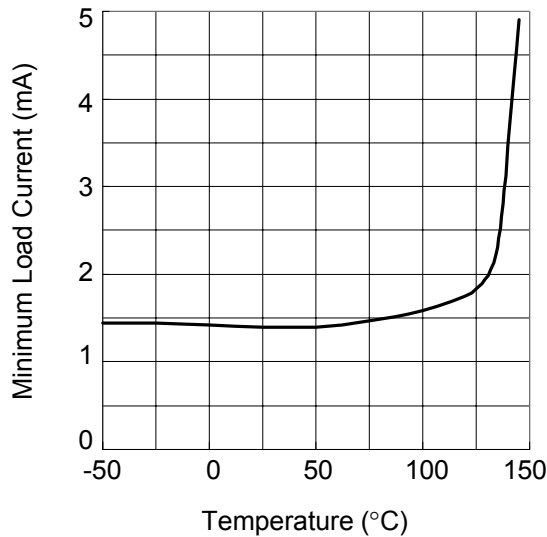

Adjust Pin Current vs Temperature

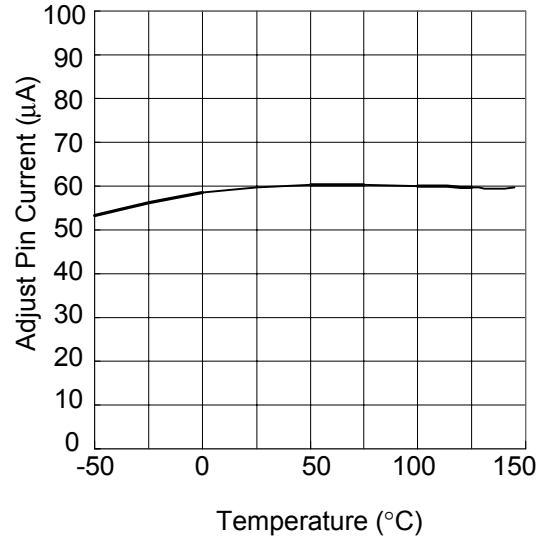

Ripple Rejection vs Frequency

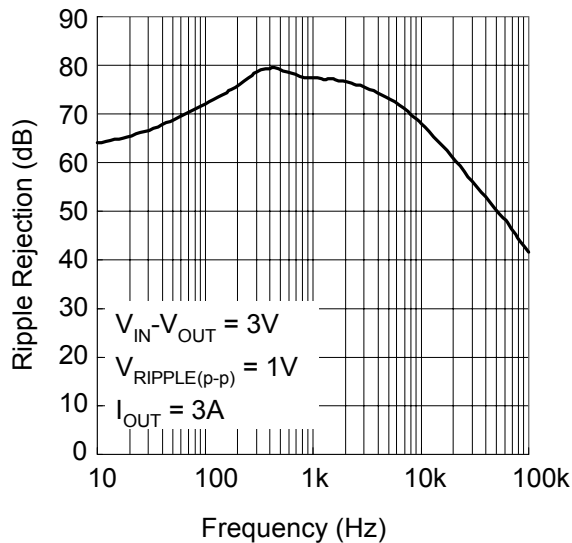

Maximum Power Dissipation\*

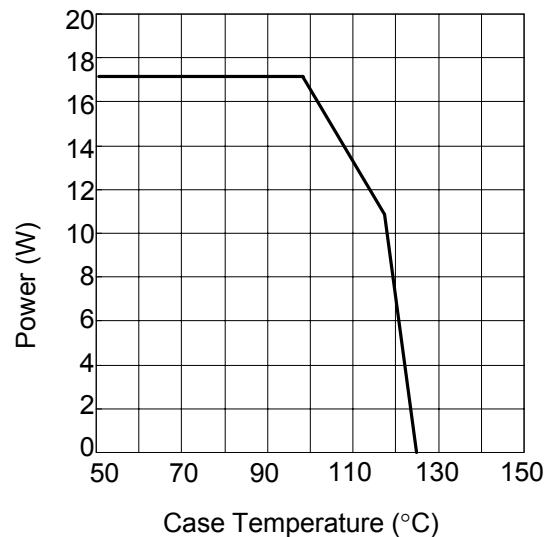

\* as Limited by Maximum Jcnction Temperature

**Package Information**

TO-220 ( Reference JEDEC Registration TO-220)

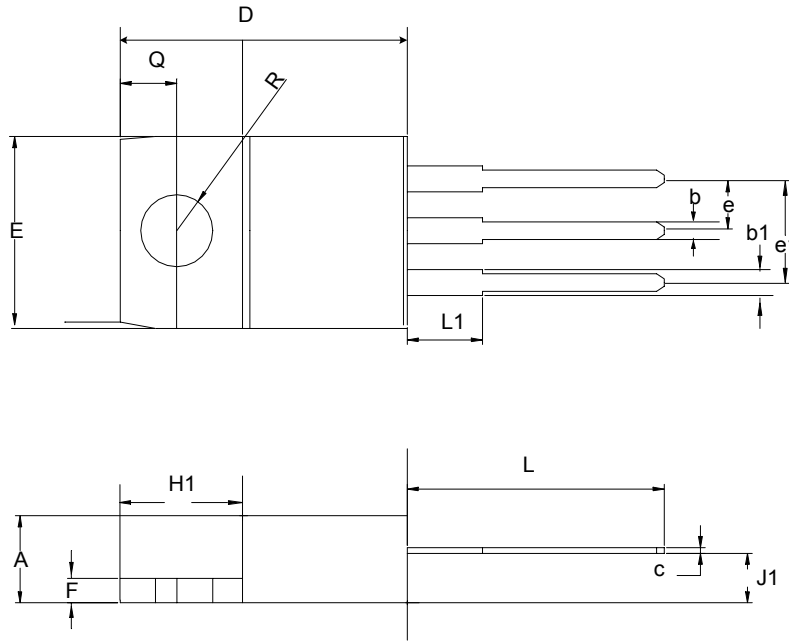

Dim	Millimeters		Inches	
	Min.	Max.	Min.	Max.
A	3.56	4.83	0.140	0.190
b1	1.14	1.78	0.045	0.070
b	0.51	1.14	0.020	0.045
c	0.31	1.14	0.012	0.045
D	14.23	16.51	0.560	0.650
e	2.29	2.79	0.090	0.110
e1	4.83	5.33	0.190	0.210
E	9.65	10.67	0.380	0.420
F	0.51	1.40	0.020	0.055
H1	5.84	6.86	0.230	0.270
J1	2.03	2.92	0.080	0.115
L	12.7	14.73	0.500	0.580
L1	3.65	6.35	0.143	0.250
R	3.53	4.09	0.139	0.161
Q	2.54	3.43	0.100	0.135

**Package Information**

TO-252( Reference JEDEC Registration TO-252)

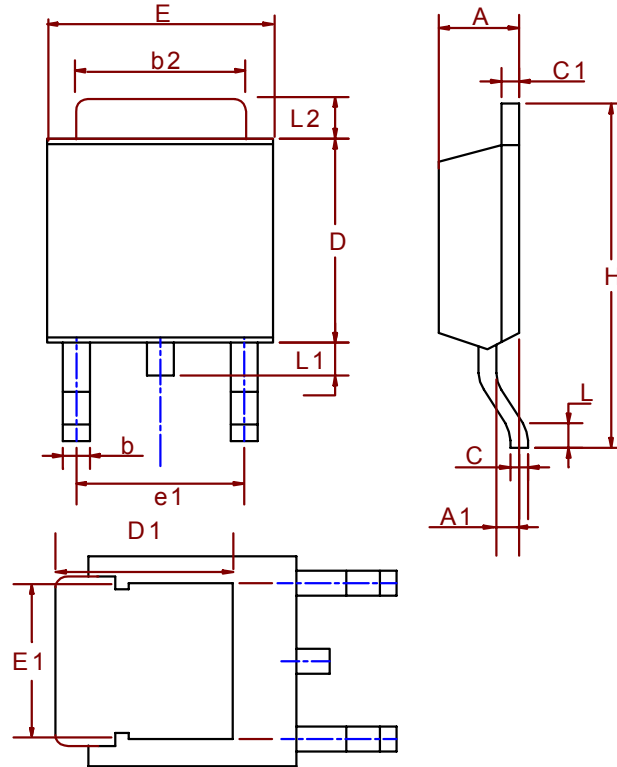

Dim	Millimeters		Inches	
	Min.	Max.	Min.	Max.
A	2.18	2.39	0.086	0.094
A1	0.89	1.27	0.035	0.050
b	0.508	0.89	0.020	0.035
b2	5.207	5.461	0.205	0.215
C	0.46	0.58	0.018	0.023
C1	0.46	0.58	0.018	0.023
D	5.334	6.22	0.210	0.245
D1	5.2 REF		0.205 REF	
E	6.35	6.73	0.250	0.265
E1	5.3 REF		0.209 REF	
e1	3.96	5.18	0.156	0.204
H	9.398	10.41	0.370	0.410
L	0.51		0.020	
L1	0.64	1.02	0.025	0.040
L2	0.89	2.032	0.035	0.080

**Package Information**

TO-263

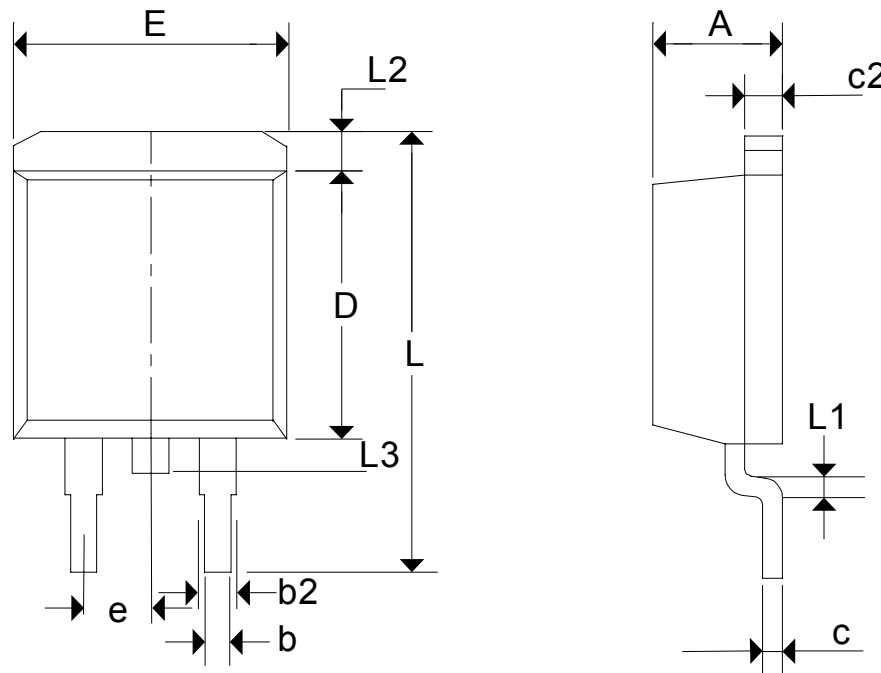

Dim	Millimeters		Inches	
	Min.	Max.	Min.	Max.
A	4.06	4.83	0.160	0.190
b	0.51	0.992	0.02	0.039
b2	1.14	1.399	0.045	0.055
c	0.38 TYP.		0.015 TYP.	
c2	1.14	1.40	0.045	0.055
D	8.64	9.65	0.340	0.380
E	9.66	10.299	0.380	0.405
e	2.543 BSC.		0.100 BSC.	
L	14.60	15.88	0.575	0.625
L1	2.24	2.84	0.090	0.110
L2	-	2.92	-	0.115
L3	1.20	1.78	0.050	0.070



## Physical Specifications

Terminal Material	Solder-Plated Copper (Solder Material : 90/10 or 63/37 SnPb), 100%Sn
Lead Solderability	Meets EIA Specification RSI86-91, ANSI/J-STD-002 Category 3.

### Reflow Condition (IR/Convection or VPR Reflow)

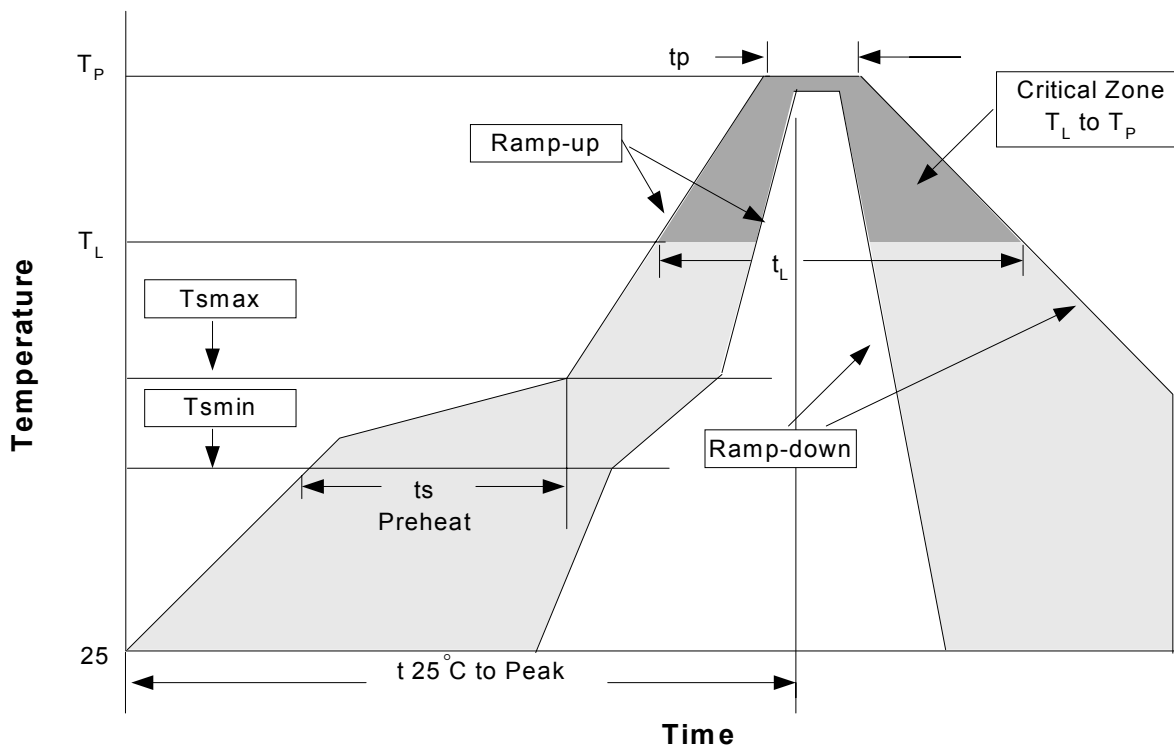

### Classification Reflow Profiles

Profile Feature	Sn-Pb Eutectic Assembly	Pb-Free Assembly
Average ramp-up rate ( $T_L$ to $T_P$ )	3°C/second max.	3°C/second max.
Preheat		
- Temperature Min ( $T_{smin}$ )	100°C	150°C
- Temperature Max ( $T_{smax}$ )	150°C	200°C
- Time (min to max) ( $t_s$ )	60-120 seconds	60-180 seconds
Time maintained above:		
- Temperature ( $T_L$ )	183°C	217°C
- Time ( $t_L$ )	60-150 seconds	60-150 seconds
Peak/Classification Temperature ( $T_p$ )	See table 1	See table 2
Time within 5°C of actual Peak Temperature ( $t_p$ )	10-30 seconds	20-40 seconds
Ramp-down Rate	6°C/second max.	6°C/second max.
Time 25°C to Peak Temperature	6 minutes max.	8 minutes max.

Notes: All temperatures refer to topside of the package .Measured on the body surface.

## Classification Reflow Profiles(Cont.)

Table 1. SnPb Eutectic Process – Package Peak Reflow Temperatures

Package Thickness	Volume mm <sup>3</sup> <350	Volume mm <sup>3</sup> ≥350
<2.5 mm	240 +0/-5°C	225 +0/-5°C
≥2.5 mm	225 +0/-5°C	225 +0/-5°C

Table 2. Pb-free Process – Package Classification Reflow Temperatures

Package Thickness	Volume mm <sup>3</sup> <350	Volume mm <sup>3</sup> 350-2000	Volume mm <sup>3</sup> >2000
<1.6 mm	260 +0°C*	260 +0°C*	260 +0°C*
1.6 mm – 2.5 mm	260 +0°C*	250 +0°C*	245 +0°C*
≥2.5 mm	250 +0°C*	245 +0°C*	245 +0°C*

\*Tolerance: The device manufacturer/supplier **shall** assure process compatibility up to and including the stated classification temperature (this means Peak reflow temperature +0°C. For example 260°C+0°C) at the rated MSL level.

## Reliability Test Program

Test item	Method	Description
SOLDERABILITY	MIL-STD-883D-2003	245°C, 5 SEC
HOLT	MIL-STD-883D-1005.7	1000 Hrs Bias @125°C
PCT	JESD-22-B,A102	168 Hrs, 100%RH, 121°C
TST	MIL-STD-883D-1011.9	-65°C~150°C, 200 Cycles
ESD	MIL-STD-883D-3015.7	VHBM > 2KV, VMM > 200V
Latch-Up	JESD 78	10ms, 1 <sub>tr</sub> > 100mA

## Carrier Tape & Reel Dimension

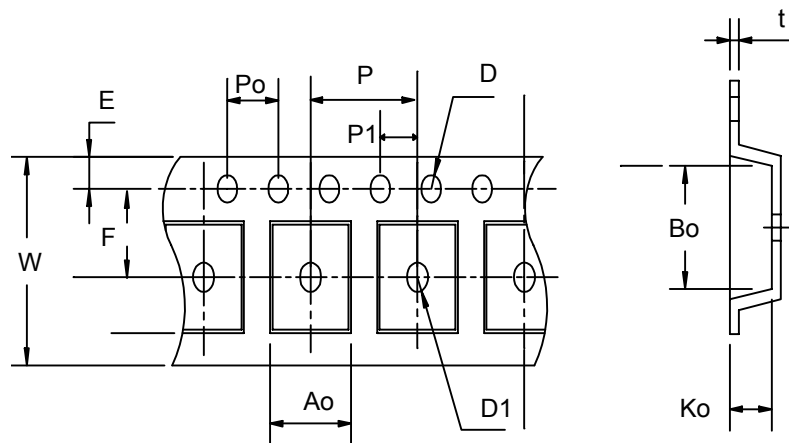

**Carrier Tape & Reel Dimension(Cont.)**

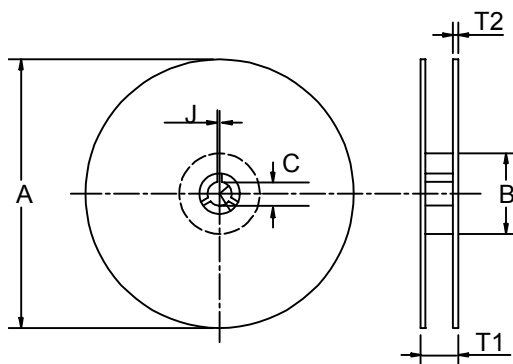

Application	A	B	C	J	T1	T2	W	P	E
TO-252	330 ±3	100 ± 2	13 ± 0.5	2 ± 0.5	16.4 +0.3 -0.2	2.5 ± 0.5	16 + 0.3 -0.1	8 ± 0.1	1.75 ± 0.1
	F	D	D1	Po	P1	Ao	Bo	Ko	t
	7.5 ± 0.1	1.5 +0.1	1.5 ± 0.25	4.0 ± 0.1	2.0 ± 0.1	6.8 ± 0.1	10.4 ± 0.1	2.5 ± 0.1	0.3 ± 0.05
Application	A	B	C	J	T1	T2	W	P	E
TO-263	380 ±3	80 ± 2	13 ± 0.5	2 ± 0.5	24 ± 4	2 ± 0.3	24 + 0.3 -0.1	16 ± 0.1	1.75 ± 0.1
	F	D	D1	Po	P1	Ao	Bo	Ko	t
	11.5 ± 0.1	1.5 +0.1	1.5 ± 0.25	4.0 ± 0.1	2.0 ± 0.1	10.8 ± 0.1	16.1 ± 0.1	5.2 ± 0.1	0.35 ± 0.013

(mm)

**Cover Tape Dimensions**

Application	Carrier Width	Cover Tape Width	Devices Per Reel
TO- 252	16	13.3	2500
TO- 263	24	21.3	1000

**Customer Service**

**Anpec Electronics Corp.**

Head Office :

5F, No. 2 Li-Hsin Road, SBIP,

Hsin-Chu, Taiwan, R.O.C.

Tel : 886-3-5642000

Fax : 886-3-5642050

Taipei Branch :

7F, No. 137, Lane 235, Pac Chiao Rd.,

Hsin Tien City, Taipei Hsien, Taiwan, R. O. C.

Tel : 886-2-89191368

Fax : 886-2-89191369