

Features

- **Ultra Low Quiescent Current: 4mA**
- **Ultra Low Dropout Voltage: 200mV@3.3V/150mA**
- **Fixed Output Voltages: 1.2V~3.5V, Steps 100mV**
- **Guaranteed 150mA Output Current**
- **Stable with 1mF Output Capacitor**
- **Ceramic Capacitor can be used**
- **Current-Limit Protection**
- **Controlled Short Circuit Current: 50mA**
- **Build-in Thermal Protection**
- **SOT-23, SOT-23-5, and SOT-89 Packages**
- **Lead Free and Green Devices Available (RoHS Compliant)**

General Description

The APL5101/2 are micro-power and ultra low dropout linear regulators, which operate from 2V to 6V input voltage and deliver up to 150mA. Typical dropout voltage is only 200mV at 150mA loading. Designed for use in battery-powered system, the low 4 μ A quiescent current makes it an ideal choice. Design with an internal P-channel MOSFET pass transistor, the APL5101/2 maintain a low supply current, independent of the load current and dropout voltage.

Other features include thermal-shutdown protection and current limit protection to ensure specified output current and controlled short-circuit current. The APL5101/2 regulators come in a miniature SOT-23, SOT-23-5, and SOT-89 packages.

Applications

- **Hand-Held Equipment**
- **RTC or CMOS Backup Power**
- **Battery Powered Equipment**

Pin Configuration

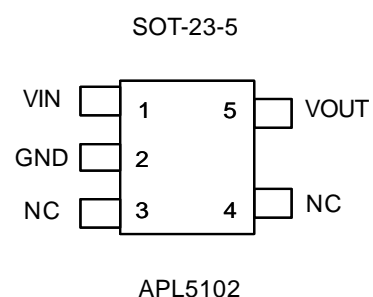
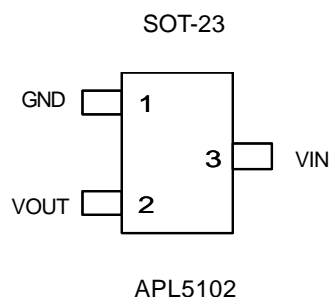
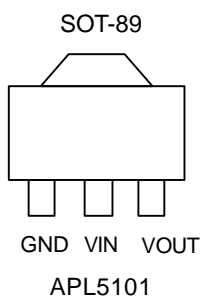
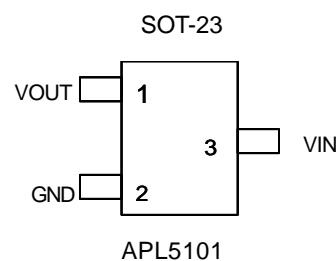
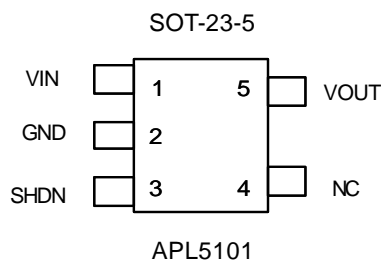

ANPEC reserves the right to make changes to improve reliability or manufacturability without notice, and advise customers to obtain the latest version of relevant information to verify before placing orders.

Ordering and Marking Information

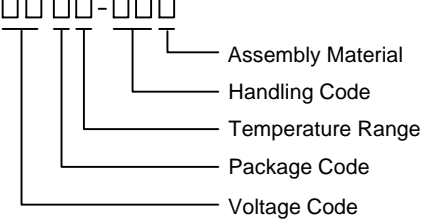
<p>APL5101/2 - □□□□-□□□□</p>  <p>Assembly Material Handling Code Temperature Range Package Code Voltage Code</p>	<p>Package Code A : SOT-23 B : SOT-23-5 D : SOT-89 Operating Ambient Temperature Range I : -40 to 85 °C Handling Code TR : Tape & Reel Voltage Code : 12 : 1.2V ~ 35 : 3.5V Assembly Material L : Lead Free Device G : Halogen and Lead Free Device</p>
<p>APL5101 -12 A/B: 105X X - Date Code : 5 - 1.2V</p>	<p>APL5101 -12 D: APL5101 XXXXX12 XXXXX - Date Code : 12 - 1.2V</p>
<p>APL5102 -12 A/B: AB5X X - Date Code : 5 - 1.2V</p>	<p>APL5102 -12 D: APL5102 XXXXX12 XXXXX - Date Code : 12 - 1.2V</p>

Note: ANPEC lead-free products contain molding compounds/die attach materials and 100% matte tin plate termination finish; which are fully compliant with RoHS. ANPEC lead-free products meet or exceed the lead-free requirements of IPC/JEDEC J-STD-020D for MSL classification at lead-free peak reflow temperature. ANPEC defines "Green" to mean lead-free (RoHS compliant) and halogen free (Br or Cl does not exceed 900ppm by weight in homogeneous material and total of Br and Cl does not exceed 1500ppm by weight).

SOT-23 and SOT-23-5 packages

Product Name	Marking	Product Name	Marking
APL5101-12A/B	105X	APL5102-12A/B	AB5X
APL5101-13A/B	107X	APL5102-13A/B	AB7X
APL5101-14A/B	108X	APL5102-14A/B	AB8X
APL5101-15A/B	109X	APL5102-15A/B	AB9X
APL5101-16A/B	10AX	APL5102-16A/B	ABAX
APL5101-17A/B	10BX	APL5102-17A/B	ABBX
APL5101-18A/B	10CX	APL5102-18A/B	ABCX
APL5101-19A/B	10DX	APL5102-19A/B	ABDX
APL5101-20A/B	10EX	APL5102-20A/B	ABEX
APL5101-21A/B	10FX	APL5102-21A/B	ABFX
APL5101-22A/B	10GX	APL5102-22A/B	ABGX
APL5101-23A/B	10HX	APL5102-23A/B	ABHX
APL5101-24A/B	10IX	APL5102-24A/B	ABIX
APL5101-25A/B	10JX	APL5102-25A/B	ABJX
APL5101-26A/B	10KX	APL5102-26A/B	ABKX
APL5101-27A/B	10LX	APL5102-27A/B	ABLX
APL5101-28A/B	10MX	APL5102-28A/B	ABMX
APL5101-29A/B	10NX	APL5102-29A/B	ABNX
APL5101-30A/B	10OX	APL5102-30A/B	ABOX
APL5101-31A/B	10PX	APL5102-31A/B	ABPX
APL5101-32A/B	10QX	APL5102-32A/B	ABQX
APL5101-33A/B	10RX	APL5102-33A/B	ABRX
APL5101-34A/B	10SX	APL5102-34A/B	ABSX
APL5101-35A/B	10TX	APL5102-35A/B	ABTX

Absolute Maximum Ratings

Symbol	Parameter	Rating	Unit
V_{IN}, V_{OUT}	Input Voltage or Out Voltage	6.5	V
SHDN	VOOUT Shutdown Control Pin	6.5	V
$R_{TH,JA}$	Thermal Resistance-Junction to Ambient SOT-23 SOT-23-5 SOT-89	260 260 180	$^{\circ}C/W$
$R_{TH,JC}$	Thermal Resistance-Junction to Ambient SOT-23 SOT-23-5 SOT-89	130 130 90	$^{\circ}C/W$
P_D	Power Dissipation	Internally Limited	W
T_J	Junction Temperature Range	-40 to 150	$^{\circ}C$
T_{STG}	Storage Temperature Range	-65 to +150	$^{\circ}C$
T_L	Maximum Lead Soldering Temperature, 10 Seconds	260	$^{\circ}C$

Electrical Characteristics

Unless otherwise noted these specifications apply over full temperature, $V_{IN} = 5V$, $C_{IN} = C_{OUT} = 1\mu F$, $T_A = -40$ to $85^{\circ}C$. Typical values refer to $T_A = 25^{\circ}C$.

Symbol	Parameter	Test Conditions	APL5101/2			Unit
			Min.	Typ.	Max.	
V_{IN}	Input Voltage		2	-	6	V
V_{OUT}	Output Voltage Accuracy	$V_{IN} = 5V$	-2	-	2	%
	Output Voltage Range		1.2	-	3.5	V
I_{LIMIT}	Current-Limit	$V_{IN} = 5V$	250	300	370	mA
I_Q	Quiescent Current	$I_{OUT} = 0mA$	-	4	7	μA
		$I_{OUT} = 150mA$	-	4	10	
	Shutdown Supply Current	$V_{SHDN} = High$	-	0.1	1	
I_{OUT}	Load Current		150	-	-	mA
REG _{LINE}	Line Regulation	$V_{OUT} + 0.5V < V_{IN} < 6V$, $I_{OUT} = 10mA$	-	2	10	mV
REG _{LOAD}	Load Regulation	$V_{IN} = 5V$, $0mA < I_{OUT} < I_{MAX}$	-	15	30	mV
V_{DROP}	Dropout Voltage ^(Note)	$V_{OUT} = 1.4V$, $I_{OUT} = 150mA$	-	1000	1300	mV
		$V_{OUT} = 1.8V$, $I_{OUT} = 150mA$	-	600	900	
		$V_{OUT} = 3.3V$, $I_{OUT} = 150mA$	-	200	300	
PSRR	Ripple Rejection	$F = 1kHz$, $C_{OUT} = 1\mu F$, $I_{OUT} = 10mA$	30	40	-	dB
I_{SHORT}	Short Circuit Current	$V_{OUT} = 0V$	-	55	-	mA

Electrical Characteristics (Cont.)

Unless otherwise noted these specifications apply over full temperature, $V_{IN} = 5V$, $C_{IN} = C_{OUT} = 1\mu F$, $T_A = -40$ to $85^\circ C$. Typical values refer to $T_A = 25^\circ C$.

Symbol	Parameter	Test Conditions	APL5101/2			Unit
			Min.	Typ.	Max.	
e_n	Noise	$F = 22Hz$ to $80kHz$, $C_{OUT} = 1\mu F$, $I_{OUT} = 10mA$	-	200	250	$\mu VRMS$
I_{SHDN}	Shutdown Input Bias Current	$V_{SHDN} = LOW$	-	0.1	1	μA
V_{SHDN}	High Threshold Voltage		1.6	-	$V_{IN}+0.3$	V
	Low Threshold Voltage		-0.3	-	0.4	V
T_{EXIT}	Shutdown Exit Delay	$V_{OUT} = 90%$, $R_{LOAD} = 25\Omega$	1.5	2	2.5	mS
OTS	Over Temperature Shutdown		120	135	-	$^\circ C$
	Over Temperature Shutdown Hysteresis		10	20	30	$^\circ C$
T_C	Output Voltage Temperature Coefficient	$T_A = -40^\circ C \sim 100^\circ C$	-	100	200	ppm/ $^\circ C$
C_{OUT}	Output Capacitor		1	-	10	μF
	ESR		10	-	1000	m Ω

Note: Dropout voltage definition: $V_{IN} - V_{OUT}$ when V_{OUT} is 2% below the value of V_{OUT} for $V_{IN} = V_{OUT} + 1V$.

Pin Description

PIN		I/O	FUNCTION
NO.	NAME		
1	VIN	I	Voltage supply input pin
2	GND		GND pin
3	SHDN	I	Shutdown control pin, high = off, low = normal
4	NC		Not connected
5	VOUT	O	Regulator output pin

Block Diagram

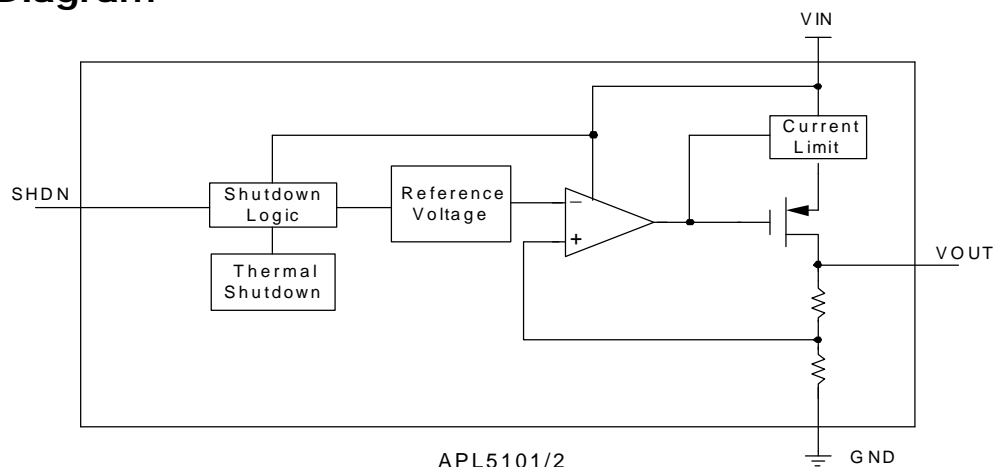

Typical Application Circuit

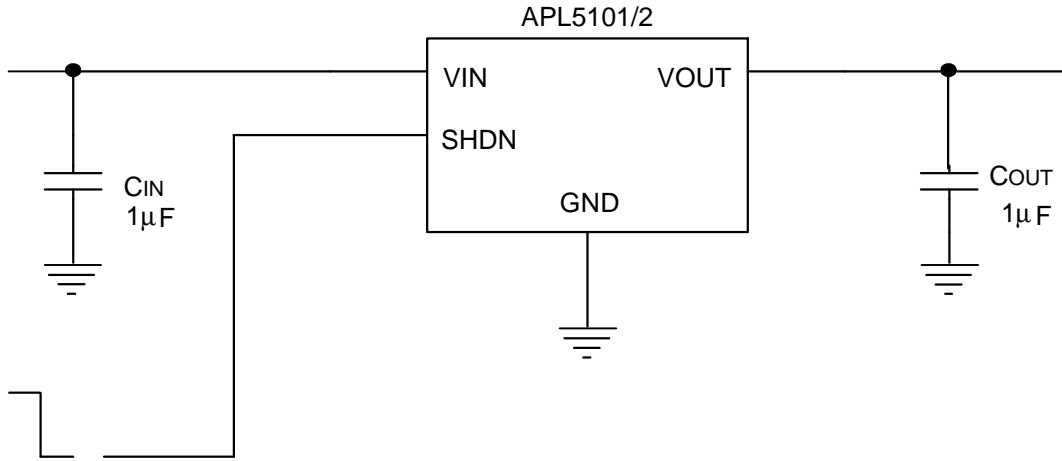

Typical Operating Characteristics

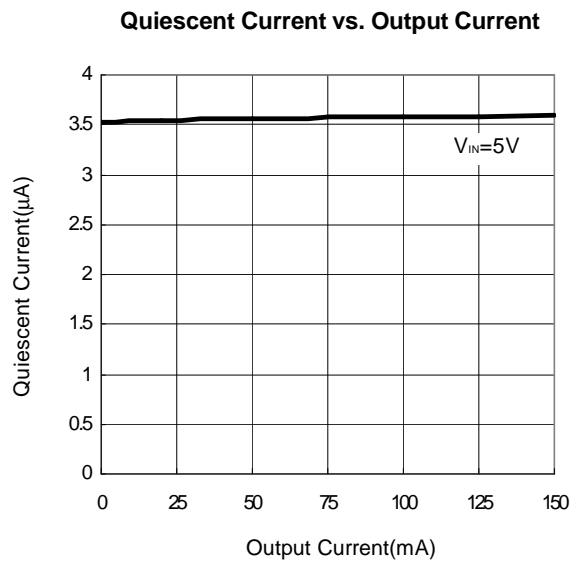
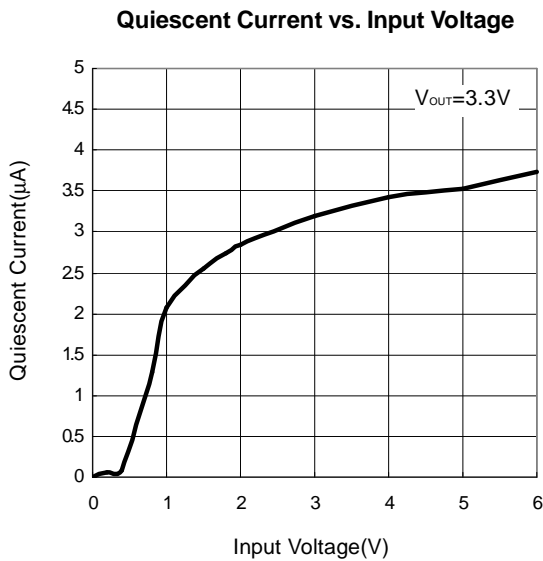

Typical Operating Characteristics (Cont.)

Output Voltage vs. Input Voltage

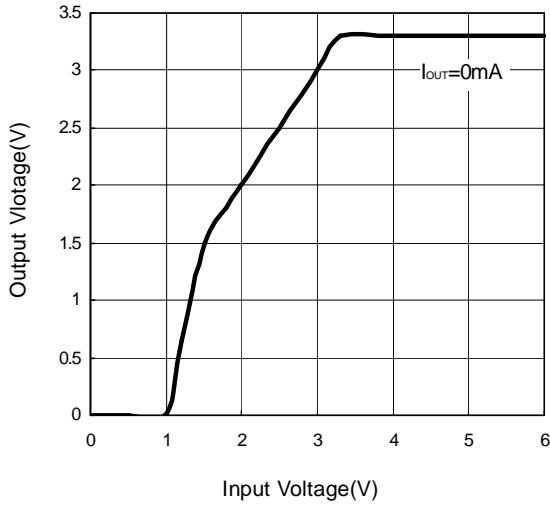

Quiescent Current vs. Ambient Temperature

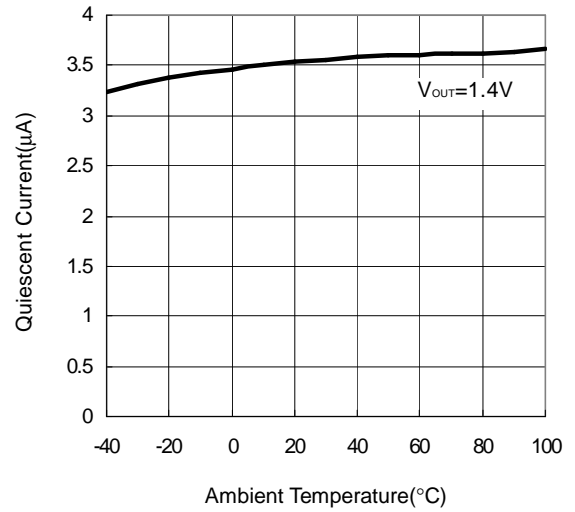

Dropout Voltage vs. Output Current

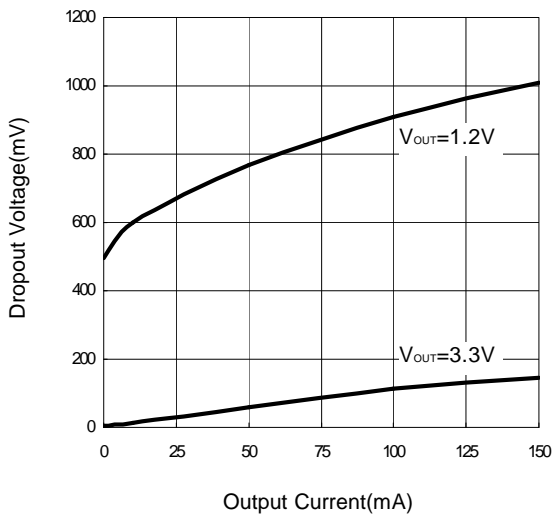

PSRR vs. Frequency

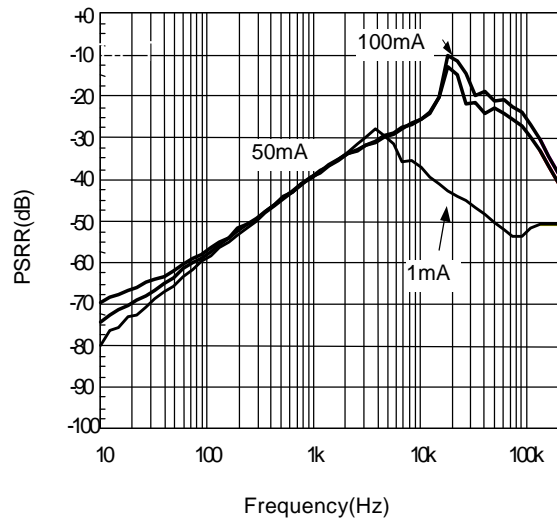

Typical Operating Characteristics (Cont.)

Load Transient Response

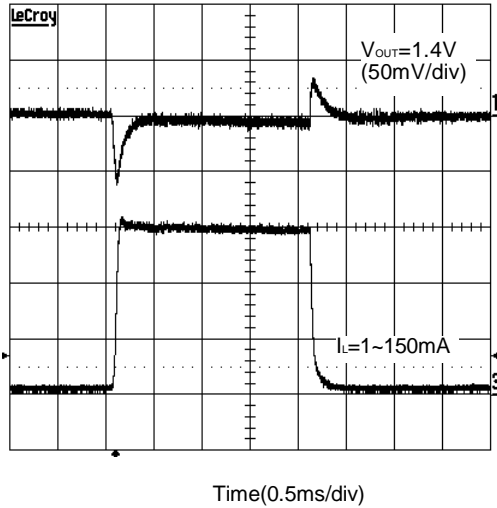

Load Transient Response

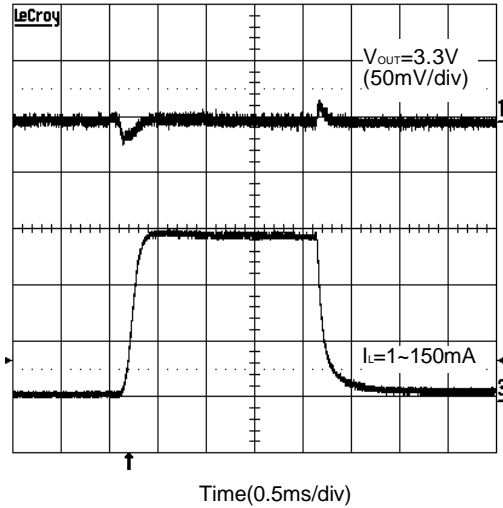

Line Transient Response

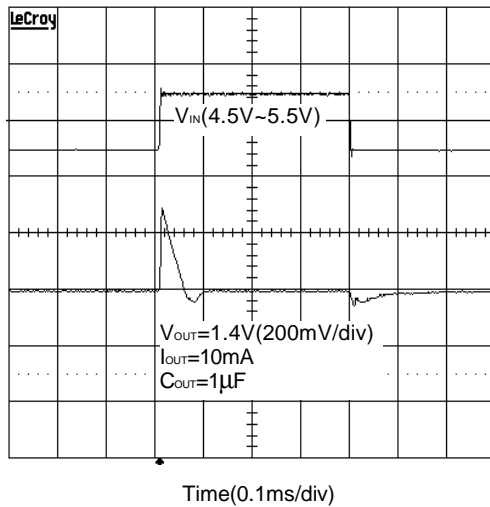

Line Transient Response

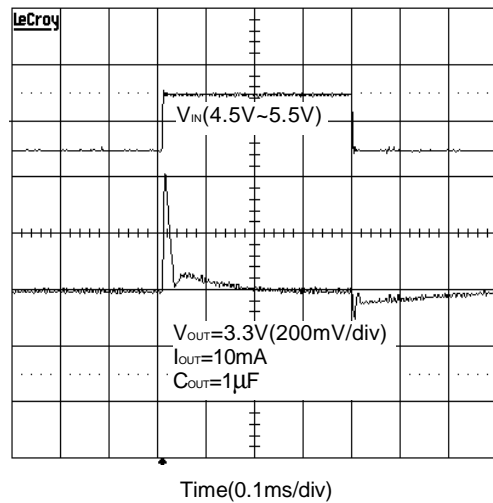

Typical Operating Characteristics (Cont.)

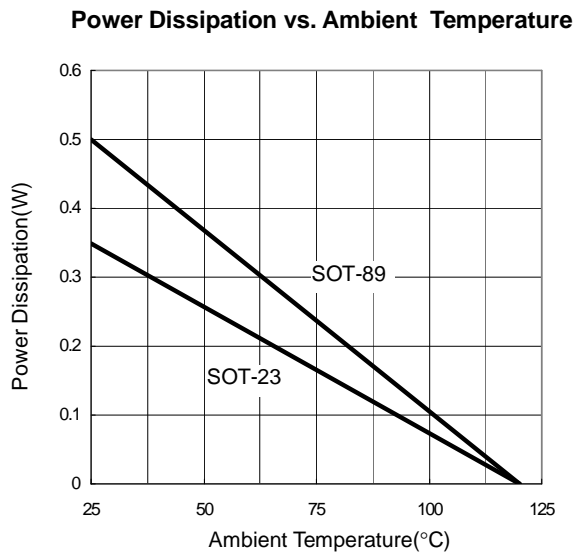
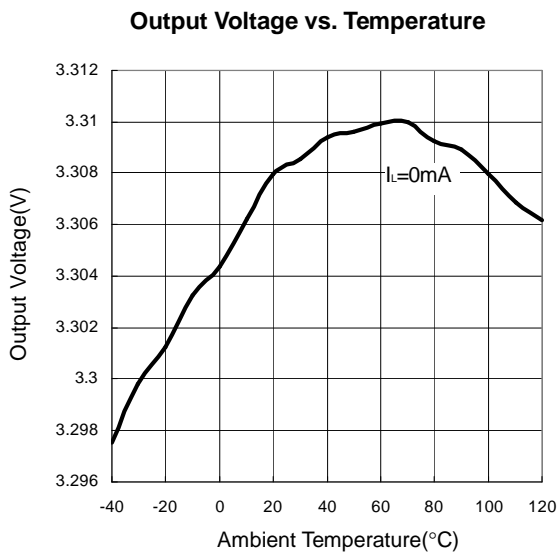
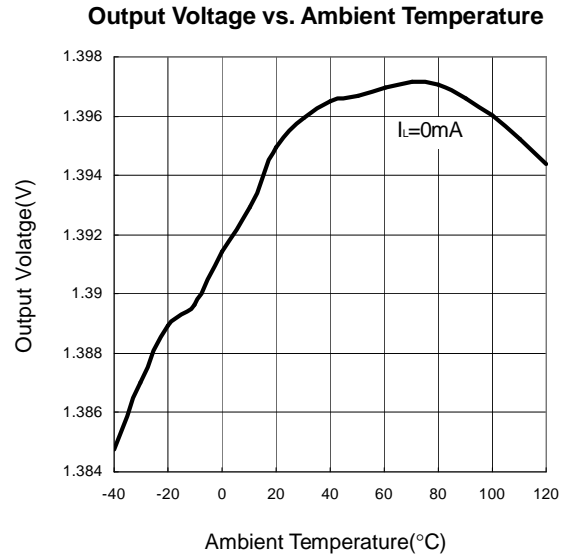
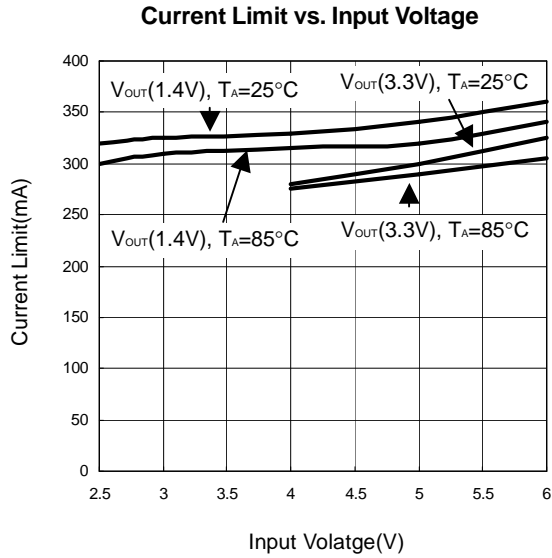

Application Information

Capacitor Selection and Regulation Stability

The APL5101/2 use at least a 1μF capacitor on the input. This capacitor can use Aluminum, Tantalum or Ceramic capacitors. Input capacitor with large value and low ESR provides better PSRR and line transient response. The output capacitor also can use Aluminum, Tantalum or Ceramic capacitor, and its proper values is recommended 1μF, ESR must be above 10mΩ Large output capacitor values can reduce noise and improve load-transient response, stability, and PSRR. With X5R and Y5V dielectrics, 1μF is sufficient at all operating temperatures. The selection of output capacitor is important because it with COUT forms a zero to provide the sufficient phase margin.

Input-Output (Dropout) Voltage

The minimum input-output voltage differential (dropout) determines the lowest usable supply voltage. The dropout voltage is the function of drain-to-source on resistance multiplied by the load current.

Current Limit and Short Circuit

APL5101/2 include a current-limit circuitry for this linear regulator. The current limit protection, which sense the current flows the P-channel MOSFET, and controls the output voltage. The point where limiting occurs is $I_{OUT}=300mA$. When output is shorted to ground, the APL5101/2 will keep short circuit current at 50mA. This design is a method for an indefinite amount of time without damaging to the part.

Thermal Protection

Thermal protection limits total power dissipation in the APL5101/2. When the junction temperature exceeds $T_J=+135^{\circ}C$, the thermal sensor generate a logic signal to turn off the pass transistor and let IC to cool. When the IC's junction temperature cools by $20^{\circ}C$, the thermal sensor will turn the pass transistor on again, resulting in a pulsed output during continuous thermal protection. Thermal protection is designed to protect the IC in the event of fault conditions. For continual operation, the junction temperature do not exceed $T_J=+125^{\circ}C$.

Operating Region and Power Dissipation

The thermal resistance of the case and circuit board, ambient and junction air temperature, and the rate of air flow all control the APL5101/2's maximum power dissipation. The power dissipation across the device is $P = I_{OUT} (V_{IN}-V_{OUT})$. The maximum power dissipation is:

$$P_{MAX} = (T_J - T_A) / (\theta_{JC} + \theta_{CA})$$

where $T_J - T_A$ is the temperature difference between the junction and ambient air. θ_{JC} is the thermal resistance of the package, θ_{CA} is the thermal resistance through the printed circuit board, copper traces, and other materials to the surrounding air. The GND pin provides an electrical connection to ground and channeling heat away. The printed circuit board (PCB) forms a heat sink and dissipates most of the heat into ambient air.

Recommended Minimum Footprint

SOT-23

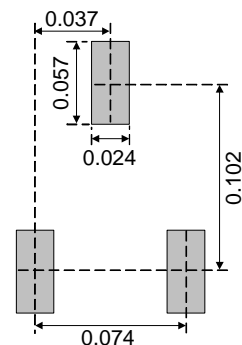

Unit : Inch

SOT-23-5

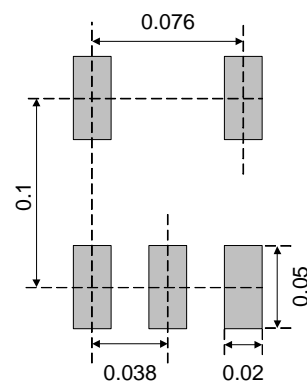

Unit : Inch

Application Information (Cont.)

Recommended Minimum Footprint (Cont.)

SOT-89

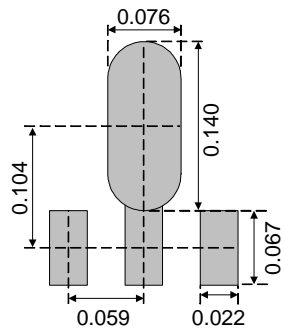

Unit : Inch

Package Information

SOT-23

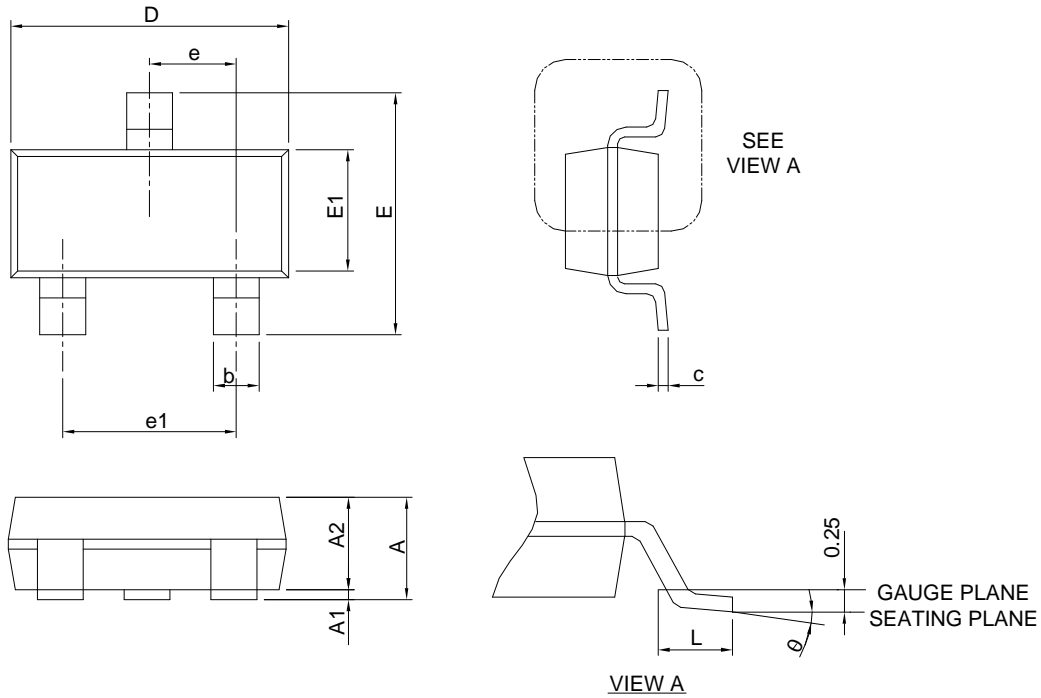

SYMBOL	SOT-23			
	MILLIMETERS		INCHES	
	MIN.	MAX.	MIN.	MAX.
A		1.45		0.057
A1	0.00	0.15	0.000	0.006
A2	0.90	1.30	0.035	0.051
b	0.30	0.50	0.012	0.020
c	0.08	0.22	0.003	0.009
D	2.70	3.10	0.106	0.122
E	2.60	3.00	0.102	0.118
E1	1.40	1.80	0.055	0.071
e	0.95 BSC		0.037 BSC	
e1	1.90 BSC		0.075 BSC	
L	0.30	0.60	0.012	0.024
θ	0°	8°	0°	8°

Note : Dimension D and E1 do not include mold flash, protrusions or gate burrs. Mold flash, protrusion or gate burrs shall not exceed 10 mil per side.

Package Information

SOT-23-5

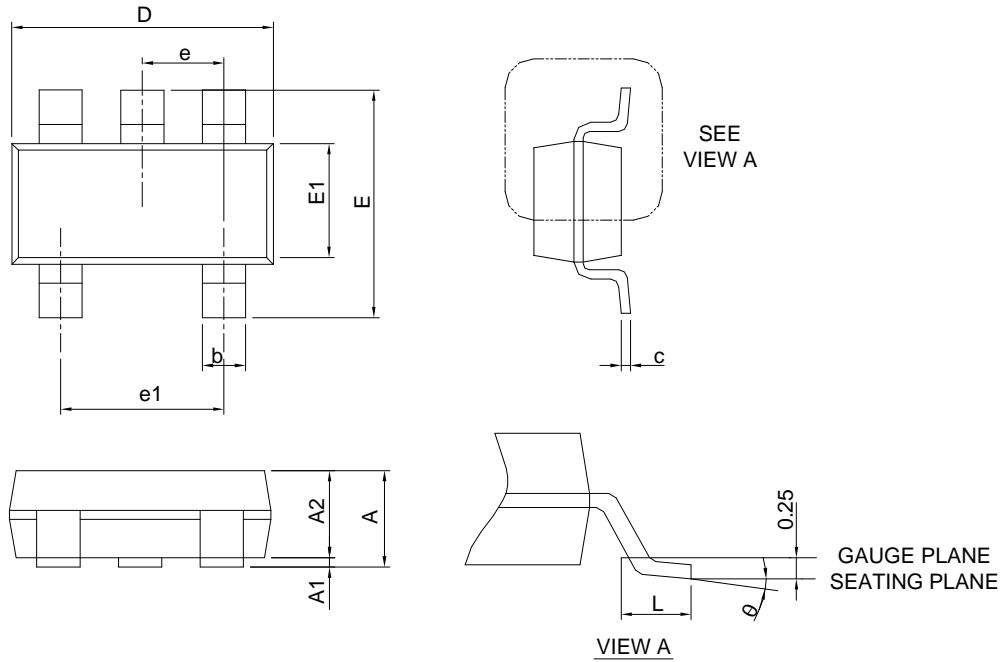

SYMBOL	SOT-23-5			
	MILLIMETERS		INCHES	
	MIN.	MAX.	MIN.	MAX.
A		1.45		0.057
A1	0.00	0.15	0.000	0.006
A2	0.90	1.30	0.035	0.051
b	0.30	0.50	0.012	0.020
c	0.08	0.22	0.003	0.009
D	2.70	3.10	0.016	0.122
E	2.60	3.00	0.102	0.118
E1	1.40	1.80	0.055	0.071
e	0.95 BSC		0.037 BSC	
e1	1.90 BSC		0.075 BSC	
L	0.30	0.60	0.012	0.024
θ	0°	8°	0°	8°

Note : 1. Follow JEDEC TO-178 AA.

2. Dimension D and E1 do not include mold flash, protrusions or gate burrs. Mold flash, protrusion or gate burrs shall not exceed 10 mil per side.

Package Information

SOT-89

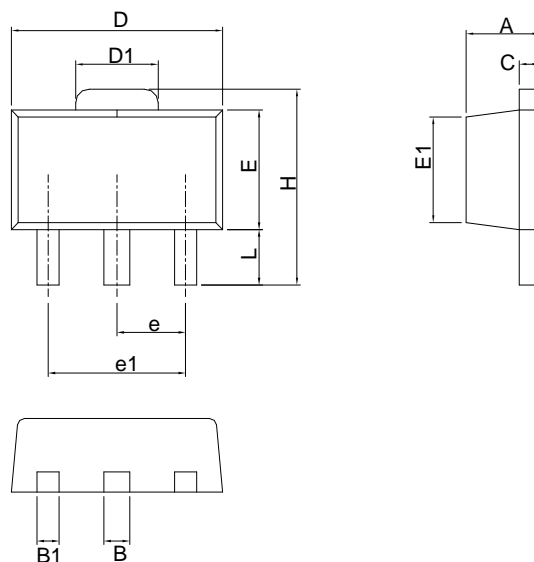

SYMBOL	SOT-89			
	MILLIMETERS		INCHES	
	MIN.	MAX.	MIN.	MAX.
A	1.40	1.60	0.055	0.063
B	0.44	0.56	0.017	0.022
B1	0.36	0.48	0.014	0.019
C	0.35	0.44	0.014	0.017
D	4.40	4.60	0.173	0.181
D1	1.62	1.83	0.064	0.072
E	2.29	2.60	0.090	0.102
E1	2.13	2.29	0.084	0.090
e	1.50 BSC		0.059 BSC	
e1	3.00 BSC		0.118 BSC	
H	3.94	4.25	0.155	0.167
L	0.89	1.20	0.035	0.047

Note : Follow JEDEC TO-243 AA.

Carrier Tape & Reel Dimensions

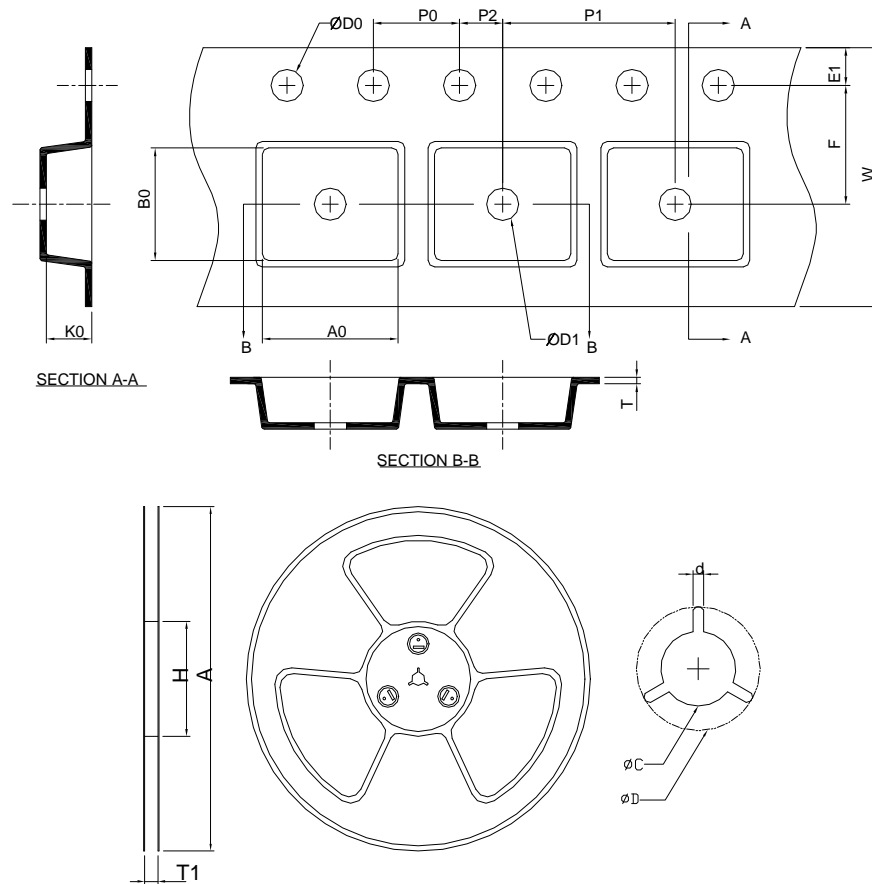

Application	A	H	T1	C	d	D	W	E1	F
SOT-23-3	178.0 ± 2.00	50 MIN.	8.4+2.00 -0.00	13.0+0.50 -0.20	1.5 MIN.	20.2 MIN.	8.0 ± 0.30	1.75 ± 0.10	3.5 ± 0.05
	P0	P1	P2	D0	D1	T	A0	B0	K0
	4.0 ± 0.10	4.0 ± 0.10	2.0 ± 0.05	1.5+0.10 -0.00	1.0 MIN.	0.6+0.00 -0.40	3.20 ± 0.20	3.10 ± 0.20	1.50 ± 0.20
Application	A	H	T1	C	d	D	W	E1	F
SOT-23-5	178.0 ± 2.00	50 MIN.	8.4+2.00 -0.00	13.0+0.50 -0.20	1.5 MIN.	20.2 MIN.	8.0 ± 0.30	1.75 ± 0.10	3.5 ± 0.05
	P0	P1	P2	D0	D1	T	A0	B0	K0
	4.0 ± 0.10	4.0 ± 0.10	2.0 ± 0.05	1.5+0.10 -0.00	1.0 MIN.	0.6+0.00 -0.40	3.20 ± 0.20	3.10 ± 0.20	1.50 ± 0.20
Application	A	H	T1	C	d	D	W	E1	F
SOT-89	178.0 ± 2.00	50 MIN.	12.4+2.00 -0.00	13.0+0.50 -0.20	1.5 MIN.	20.2 MIN.	12.0 ± 0.30	1.75 ± 0.10	5.50 ± 0.05
	P0	P1	P2	D0	D1	T	A0	B0	K0
	4.0 ± 0.10	8.0 ± 0.10	2.0 ± 0.05	1.5+0.10 -0.00	1.5 MIN.	0.6+0.00 -0.40	4.80 ± 0.20	4.50 ± 0.20	1.80 ± 0.20

(mm)

Devices Per Unit

Package Type	Unit	Quantity
SOT-23-3	Tape & Reel	3000
SOT-23-5	Tape & Reel	3000
SOT-89	Tape & Reel	1000

Taping Direction Information

SOT-23-3

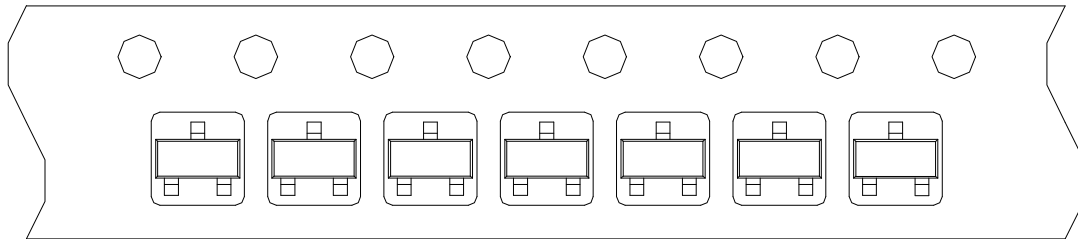

SOT-23-5

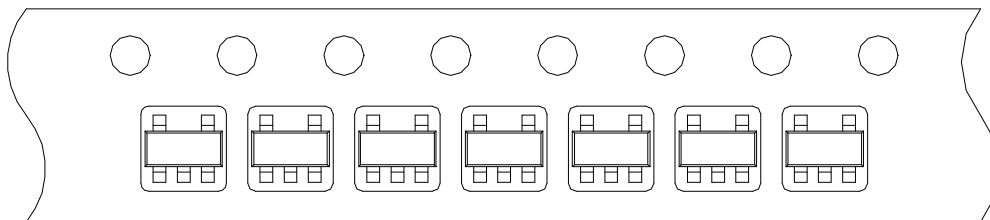
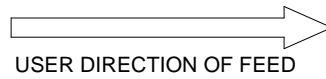

SOT-89

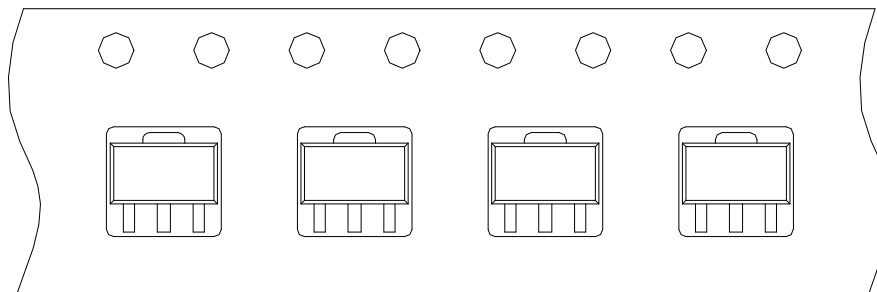
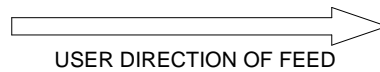

Classification Profile

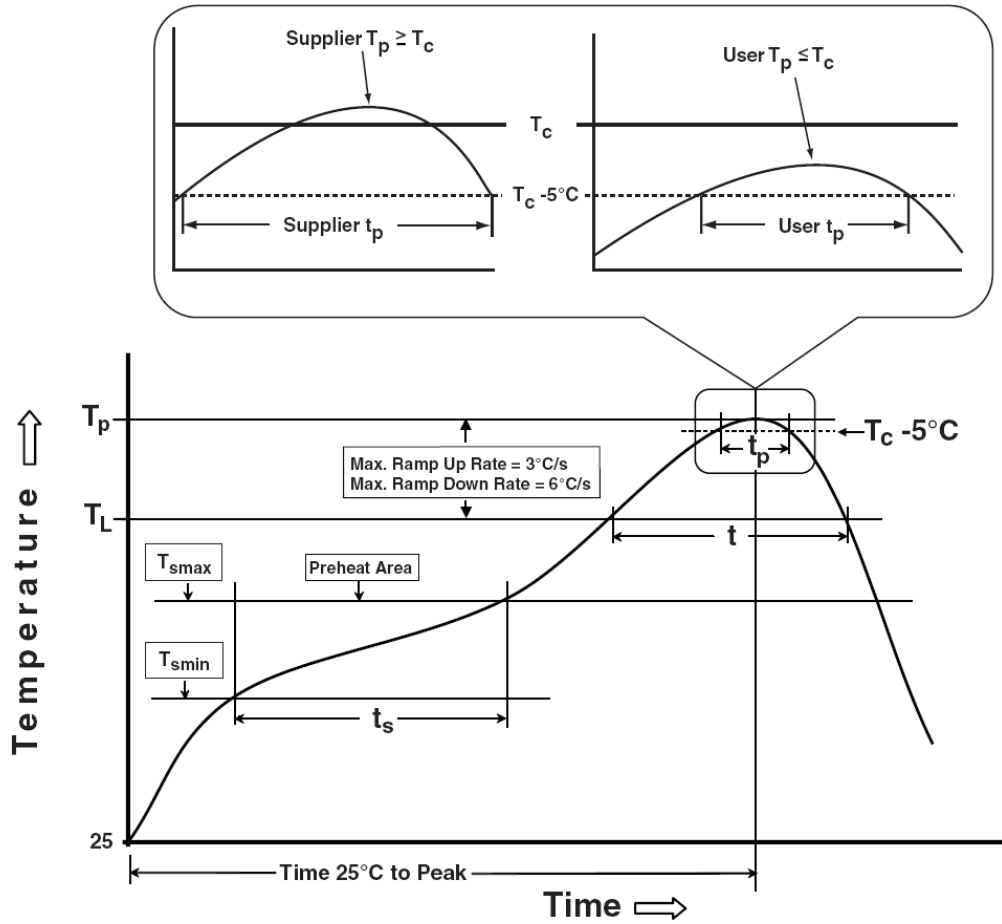

Classification Reflow Profiles

Profile Feature	Sn-Pb Eutectic Assembly	Pb-Free Assembly
Preheat & Soak Temperature min (T_{smin}) Temperature max (T_{smax}) Time (T_{smin} to T_{smax}) (t_s)	100 °C 150 °C 60-120 seconds	150 °C 200 °C 60-120 seconds
Average ramp-up rate (T_{smax} to T_p)	3 °C/second max.	3°C/second max.
Liquidous temperature (T_L) Time at liquidous (t_L)	183 °C 60-150 seconds	217 °C 60-150 seconds
Peak package body Temperature (T_p)*	See Classification Temp in table 1	See Classification Temp in table 2
Time (t_p)** within 5°C of the specified classification temperature (T_c)	20** seconds	30** seconds
Average ramp-down rate (T_p to T_{smax})	6 °C/second max.	6 °C/second max.
Time 25°C to peak temperature	6 minutes max.	8 minutes max.
* Tolerance for peak profile Temperature (T_p) is defined as a supplier minimum and a user maximum. ** Tolerance for time at peak profile temperature (t_p) is defined as a supplier minimum and a user maximum.		

Table 1. SnPb Eutectic Process – Classification Temperatures (T_c)

Package Thickness	Volume mm ³ <350	Volume mm ³ ≥350
<2.5 mm	235 °C	220 °C
≥2.5 mm	220 °C	220 °C

Table 2. Pb-free Process – Classification Temperatures (T_c)

Package Thickness	Volume mm ³ <350	Volume mm ³ 350-2000	Volume mm ³ >2000
<1.6 mm	260 °C	260 °C	260 °C
1.6 mm – 2.5 mm	260 °C	250 °C	245 °C
≥2.5 mm	250 °C	245 °C	245 °C

Reliability Test Program

Test item	Method	Description
SOLDERABILITY	JESD-22, B102	5 Sec, 245°C
HOLT	JESD-22, A108	1000 Hrs, Bias @ $T_j=125^\circ\text{C}$
PCT	JESD-22, A102	168 Hrs, 100%RH, 2atm, 121°C
TCT	JESD-22, A104	500 Cycles, -65°C~150°C
HBM	MIL-STD-883-3015.7	VHBM 2KV
MM	JESD-22, A115	VMM 200V
Latch-Up	JESD 78	10ms, 1_{tr} 100mA

Customer Service

Anpec Electronics Corp.

Head Office :

No.6, Dusing 1st Road, SBIP,

Hsin-Chu, Taiwan

Tel : 886-3-5642000

Fax : 886-3-5642050

Taipei Branch :

2F, No. 11, Lane 218, Sec 2 Jhongsing Rd.,

Sindian City, Taipei County 23146, Taiwan

Tel : 886-2-2910-3838

Fax : 886-2-2917-3838