

## Low $I_Q$ , Low Dropout 560mA Fixed Voltage Regulator

### Features

- Low Quiescent Current : 60 $\mu$ A (No load)
- Low Dropout Voltage : 600mV (@560mA)
- Very low Shutdown Current : < 0.5 $\mu$ A
- Fixed Output Voltage : 1.5V ~ 4.5V by step 0.1V increment
- Stable with 1 $\mu$ F Output Capacitor
- Stable with Aluminum, Tantalum or Ceramic Capacitors .
- No Protection Diodes Needed
- Built in Thermal Protection
- Built in Current Limit Protection
- Controlled Short Circuit Current : 50mA
- Fast Transient Response
- Short Setting Time
- SOT-23, SOT-89 and SOT-223 Packages

### General Description

The APL5508/9/R series are micropower, low dropout linear regulators, which operate from 2.7V to 6V input voltage and deliver up to 560mA. Typical dropout voltage is only 600mV at 560mA loading. Designed for use in battery-powered system, the low 60 $\mu$ A quiescent current makes it an ideal choice. Design with an internal P-channel MOSFET pass transistor, the APL5508/9/R maintain a low supply current, independent of the load current and dropout voltage. Other features include thermal-shutdown protection, current limit protection to ensure specified output current and controlled short-circuit current. The APL5508/9/R regulators come in a miniature SOT-23, SOT-89 and SOT-223 packages.

### Applications

- 5V to 3.3~4.3V Linear Regulators
- 3.3V to 1.5~2.5V Linear Regulators
- CD-R/W, DVD Player
- LAN Card, ADSL/Cable Modem
- Computers

### Pin Configuration

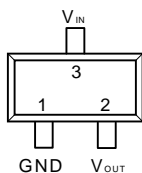

SOT-23 (Top View)  
APL5508

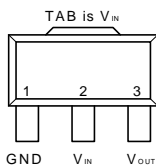

SOT-89 (Top View)  
APL5508

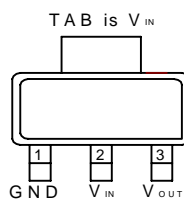

SOT-223 (Top View)  
APL5508

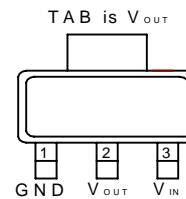

SOT-223 (Top View)  
APL5508R

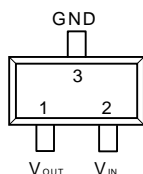

SOT-23 (Top View)  
APL5509

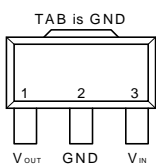

SOT-89 (Top View)  
APL5509

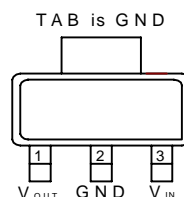

SOT-223 (Top View)  
APL5509

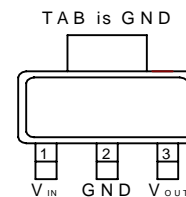

SOT-223 (Top View)  
APL5509R

ANPEC reserves the right to make changes to improve reliability or manufacturability without notice, and advise customers to obtain the latest version of relevant information to verify before placing orders.

## Ordering and Marking Information

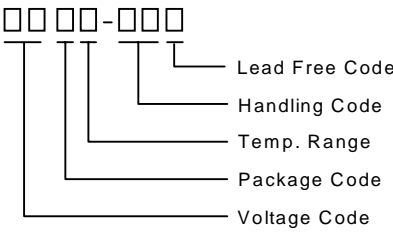
APL5508/9/R - □□□□-□□□□ 	Package Code A : SOT-23                      D : SOT-89                      V : SOT-223 Temp. Range C : 0 to 70°C Handling Code TR : Tape & Reel Voltage Code : 15 : 1.5V ~ 45 : 4.5V Lead Free Device L : Lead Free Device                      Blank : Original Device
APL5508/9/R -15 D/V : <span style="border: 1px solid black; padding: 2px;">APL5508/9/R XXXXX 15</span>	XXXXX - Date Code    ;    15 - 1.5V

## Marking Information

SOT-23 package

Product Name	Marking	Product Name	Marking	Product Name	Marking	Product Name	Marking
APL5508-15A	589X	APL5508R-15A	58R9X	APL5509-15A	599X	APL5509R-15A	59R9X
APL5508-16A	58AX	APL5508R-16A	58RAX	APL5509-16A	59AX	APL5509R-16A	59RAX
APL5508-17A	58BX	APL5508R-17A	58RBX	APL5509-17A	59BX	APL5509R-17A	59RBX
APL5508-18A	58CX	APL5508R-18A	58RCX	APL5509-18A	59CX	APL5509R-18A	59RCX
APL5508-19A	58DX	APL5508R-19A	58RDX	APL5509-19A	59DX	APL5509R-19A	59RDX
APL5508-20A	58EX	APL5508R-20A	58REX	APL5509-20A	59EX	APL5509R-20A	59REX
APL5508-21A	58FX	APL5508R-21A	58RFX	APL5509-21A	59FX	APL5509R-21A	59RFX
APL5508-22A	58GX	APL5508R-22A	58RGX	APL5509-22A	59GX	APL5509R-22A	59RGX
APL5508-23A	58HX	APL5508R-23A	58RHX	APL5509-23A	59HX	APL5509R-23A	59RHX
APL5508-24A	58IX	APL5508R-24A	58RIX	APL5509-24A	59IX	APL5509R-24A	59RIX
APL5508-25A	58JX	APL5508R-25A	58RJX	APL5509-25A	59JX	APL5509R-25A	59RJX
APL5508-26A	58KX	APL5508R-26A	58RKX	APL5509-26A	59KX	APL5509R-26A	59RKX
APL5508-27A	58LX	APL5508R-27A	58RLX	APL5509-27A	59LX	APL5509R-27A	59RLX
APL5508-28A	58MX	APL5508R-28A	58RMX	APL5509-28A	59MX	APL5509R-28A	59RMX
APL5508-29A	58NX	APL5508R-29A	58RNX	APL5509-29A	59NX	APL5509R-29A	59RNX
APL5508-30A	58OX	APL5508R-30A	58ROX	APL5509-30A	59OX	APL5509R-30A	59ROX
APL5508-31A	58PX	APL5508R-31A	58RPX	APL5509-31A	59PX	APL5509R-31A	59RPX
APL5508-32A	58QX	APL5508R-32A	58RQX	APL550932A	59QX	APL5509R-32A	59RQX
APL5508-33A	58RX	APL5508R-33A	58RRX	APL5509-33A	59RX	APL5509R-33A	59RRX
APL5508-34A	58SX	APL5508R-34A	58RSX	APL5509-34 A	59SX	APL5509R-34 A	59RSX
APL5508-35A	58TX	APL5508R-35A	58RTX	APL5509-35A	59TX	APL5509R-35A	59RTX
APL5508-43A	58UX	APL5508R-43A	58RUX	APL5509-43A	59UX	APL5509R-43A	59RUX
APL5508-45A	58VX	APL5508R-45A	58RVX	APL5509-45A	59VX	APL5509R-45A	59RVX

The last character "X" in the marking is for data code.

## Pin Description

PIN		I/O	Description
No.	Name		
1	V <sub>IN</sub>	I	Supply voltage input.
2	GND		Ground pins of the circuitry, and all ground pins must be soldered To PCB with proper power dissipation.
3	V <sub>OUT</sub>	O	Output pin of the regulator.

## Absolute Maximum Ratings

Symbol	Parameter	Rating	Unit
V <sub>IN</sub> , V <sub>OUT</sub>	Input Voltage or Out Voltage	6.5	V
R <sub>TH,JA</sub>	Thermal Resistance – Junction to Ambient	SOT-23 : 260 SOT-89 : 180 SOT-223 : 135	°C/W
R <sub>TH,JC</sub>	Thermal Resistance – Junction to Case	SOT-23 : 130 SOT-89 : 38 SOT-223 : 15	°C/W
P <sub>D</sub>	Power Dissipation	Internally Limited	W
T <sub>J</sub>	Operating Junction Temperature Control Section Power Transistor	0 to 125 0 to 150	°C
T <sub>STG</sub>	Storage Temperature Range	-65 to +150	°C
T <sub>L</sub>	Lead Temperature (Soldering, 10 second)	260	°C

## Electrical Characteristics

Unless otherwise noted these specifications apply over full temperature, C<sub>IN</sub>=C<sub>OUT</sub>=1uF, T<sub>J</sub>=0 to 125°C. Typical values refer to T<sub>J</sub>=25°C.

Symbol	Parameter	Test Conditions	APL5508/9/R			Unit
			Min.	Typ.	Max.	
V <sub>IN</sub>	Input Voltage		2.7		6	V
V <sub>OUT</sub>	Output Voltage	V <sub>OUT</sub> +1.0V < V <sub>CC</sub> <6.0V, 0mA < I <sub>OUT</sub> < I <sub>MAX</sub>	V <sub>OUT</sub> -2%	V <sub>OUT</sub>	V <sub>OUT</sub> +2%	V
I <sub>LIMIT</sub>	Circuit Current Limit	V <sub>IN</sub> =V <sub>OUT</sub> +1V		800		mA
I <sub>SHORT</sub>	Short Current	V <sub>OUT</sub> =0V		50		mA
I <sub>OUT</sub>	Load Current	V <sub>IN</sub> =V <sub>OUT</sub> +1V	560			mA
REG <sub>LINE</sub>	Line Regulation	V <sub>OUT</sub> +1V < V <sub>CC</sub> <6.0V, I <sub>OUT</sub> =1mA		1	10	mV
REG <sub>LOAD</sub>	Load Regulation	V <sub>IN</sub> =V <sub>OUT</sub> +1V, 0mA < I <sub>OUT</sub> < I <sub>MAX</sub>		20	40	mV
	Load Transient	V <sub>IN</sub> = V <sub>OUT</sub> +1V , I <sub>OUT</sub> =1mA-560mA in 1μs		150	250	mV

## Electrical Characteristics (Cont.)

Unless otherwise noted these specifications apply over full temperature,  $C_{IN}=C_{OUT}=1\mu F$ ,  $T_J=0$  to  $125^\circ C$ . Typical values refer to  $T_J=25^\circ C$ .

Symbol	Parameter	Test Conditions	APL5508/9/R			Unit	
			Min.	Typ.	Max.		
$V_{DROP}$	Dropout Voltage <sup>(Note1)</sup>	$I_{OUT}=560mA$	$1.5V \leq V_{OUT} < 2.0V$		1.1	1.3	V
			$2.0V \leq V_{OUT} < 2.5V$		0.9	1.0	
			$2.5V \leq V_{OUT} < 3V$		0.7	0.8	
			$3V \leq V_{OUT} \leq 3.5V$		0.6	0.7	
PSRR	Ripple Rejection	$F \leq 1kHz$ , $1V_{pp}$ at $V_{IN} = V_{OUT} + 1.0V$	45	55		dB	
$I_Q$	Quiescent Current	No load		60	100	$\mu A$	
		$I_{OUT}=560mA$		450	500		
OTS	Over Temperature			150		$^\circ C$	
	Over Temperature	Hysteresis		30		$^\circ C$	
TC	Output Voltage Temperature Coefficient			50		ppm/ $^\circ C$	
$C_{OUT}$	Output Capacitor			4.7		$\mu F$	
	ESR		0.01	0.1	1	Ohm	

Note1 : Dropout voltage definition :  $V_{IN}-V_{OUT}$  when  $V_{OUT}$  is 2% below the value of  $V_{OUT}$  for  $V_{IN} = V_{OUT} + 1V$

## Application Circuit

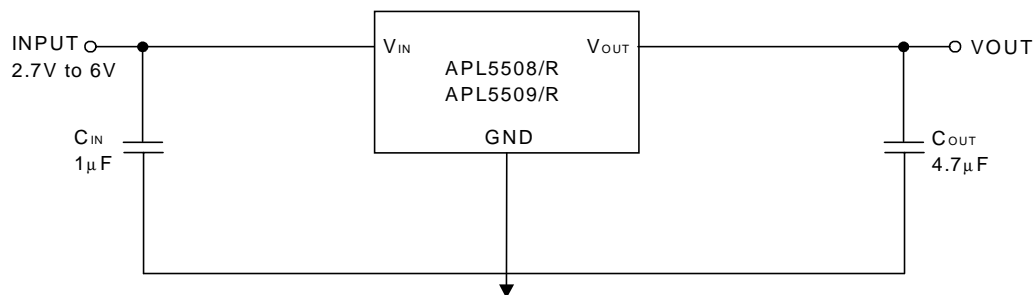

## Typical Characteristics

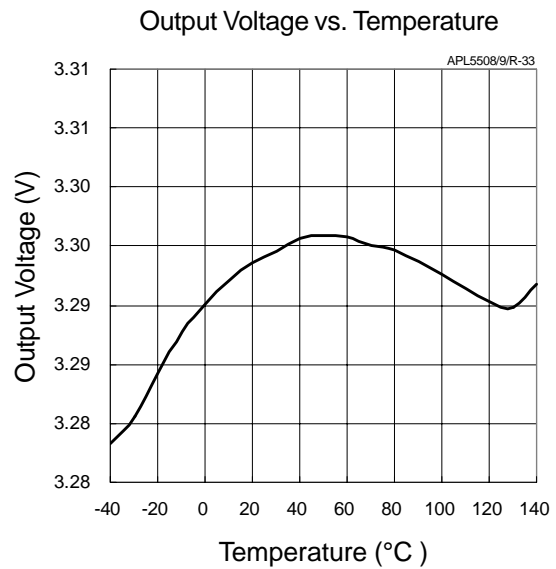
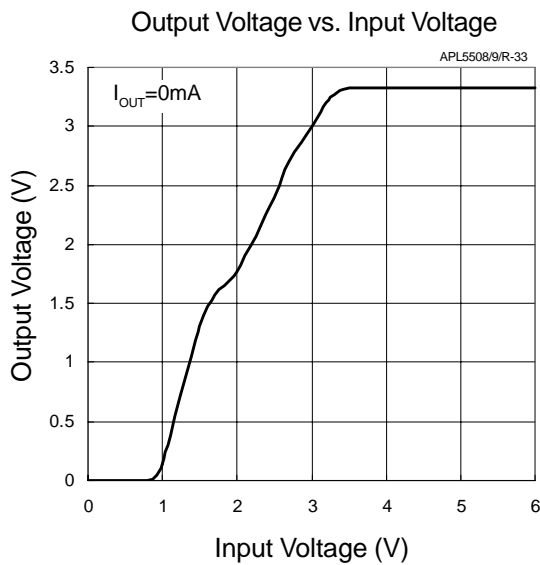
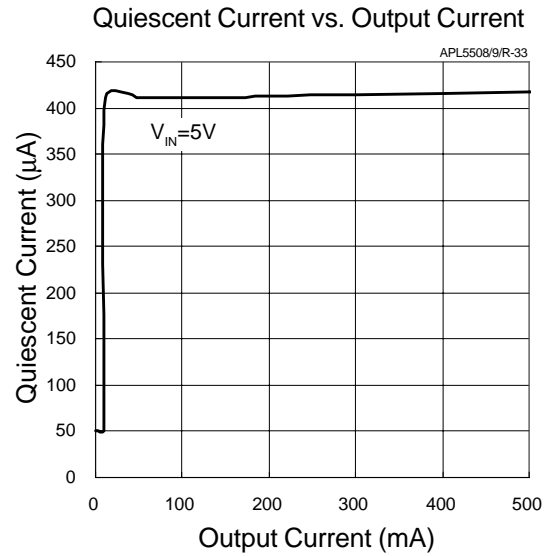
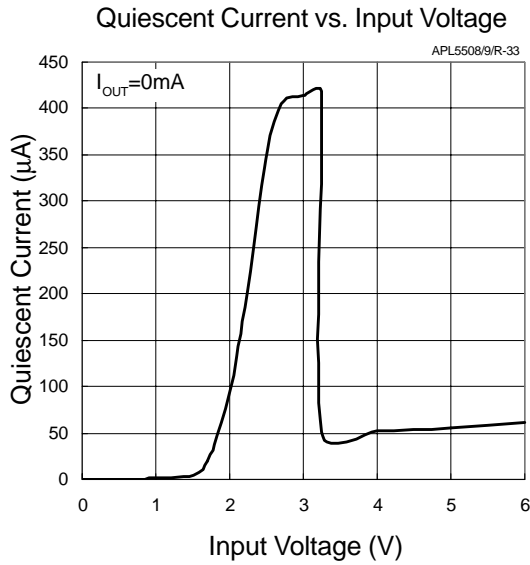

## Typical Characteristics

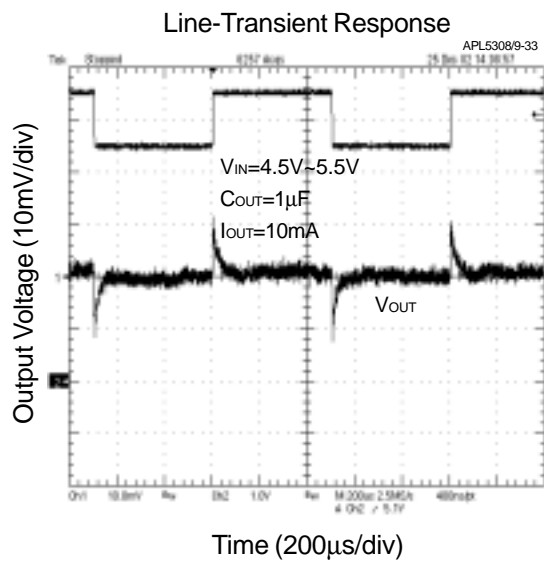
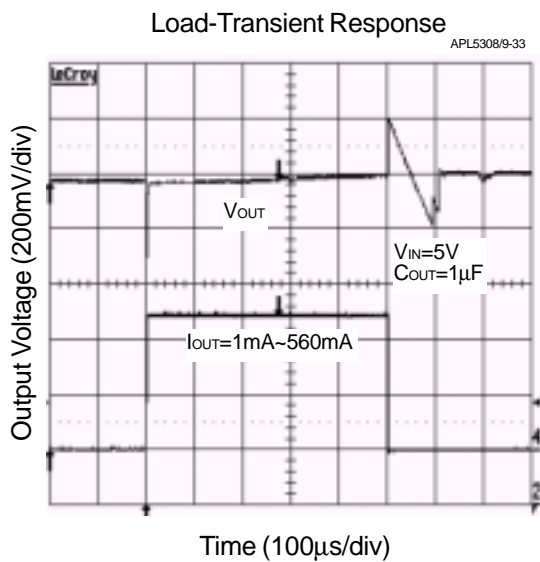
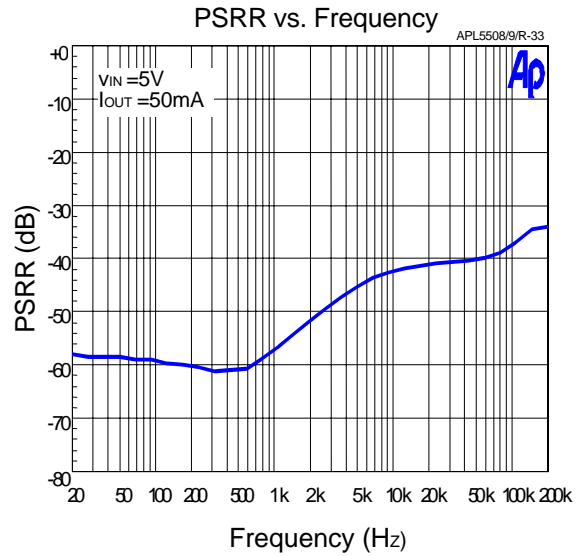
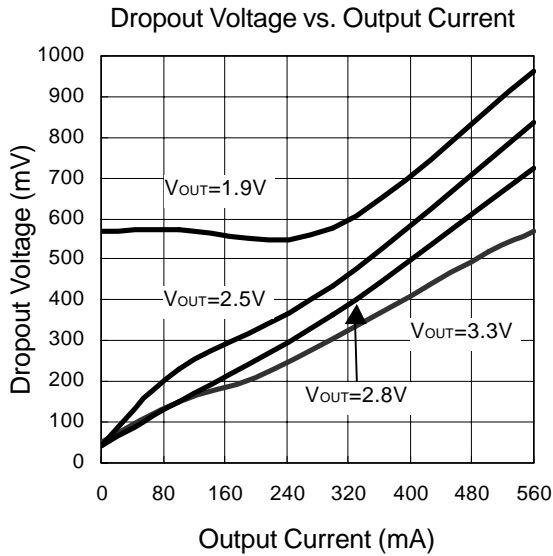

## Typical Characteristics

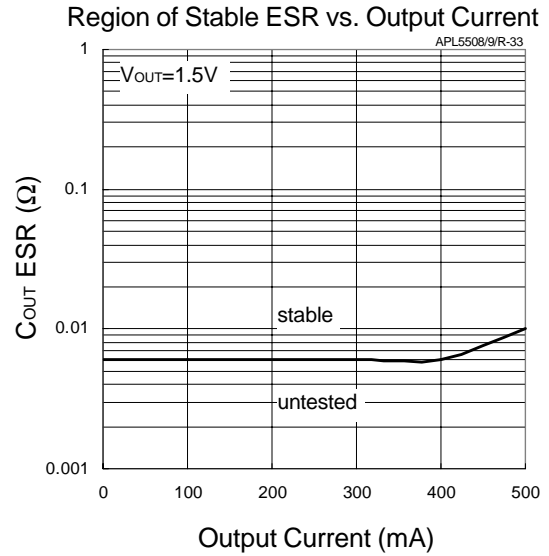
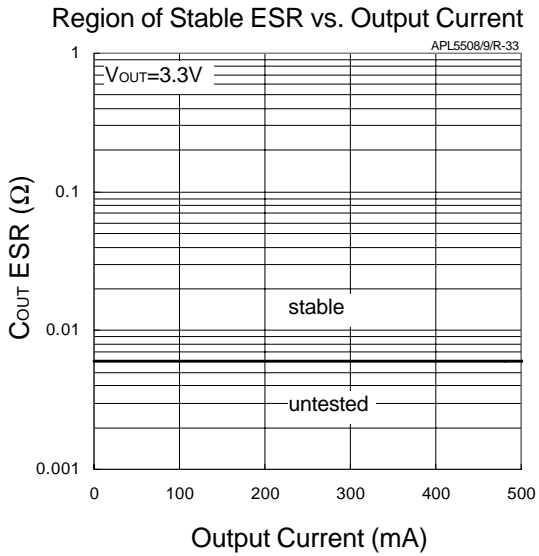

## Packaging Information

SOT-23

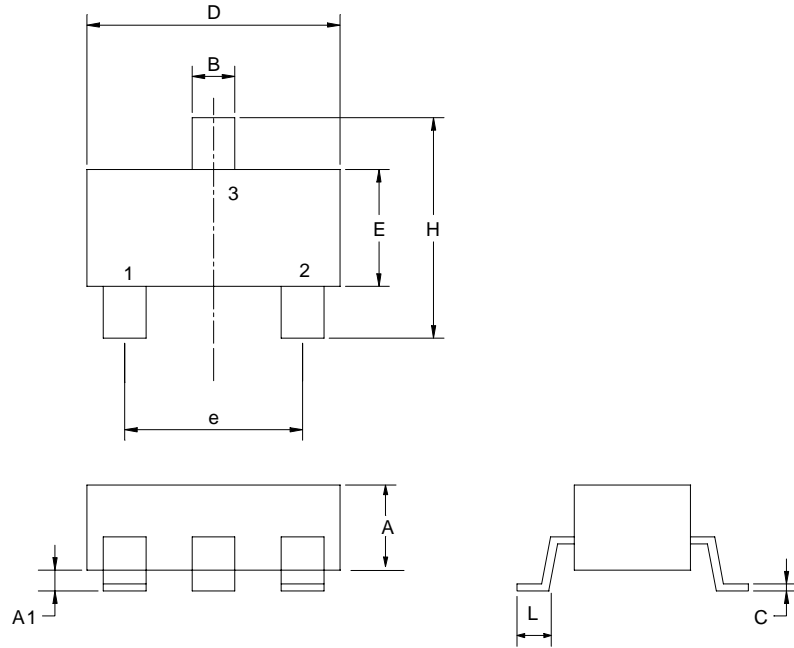

Dim	Millimeters		Inches	
	Min.	Max.	Min.	Max.
A	1.00	1.30	0.039	0.051
A1	0.00	0.10	0.000	0.004
B	0.35	0.51	0.014	0.020
C	0.10	0.25	0.004	0.010
D	2.70	3.10	0.106	0.122
E	1.40	1.80	0.055	0.071
e	1.90/2.1 BSC		0.075/0.083 BSC	
H	2.40	3.00	0.094	0.118
L	0.37		0.015	



## Packaging Information

SOT-89 (Reference EIAJ ED-7500A Registration SC-62)

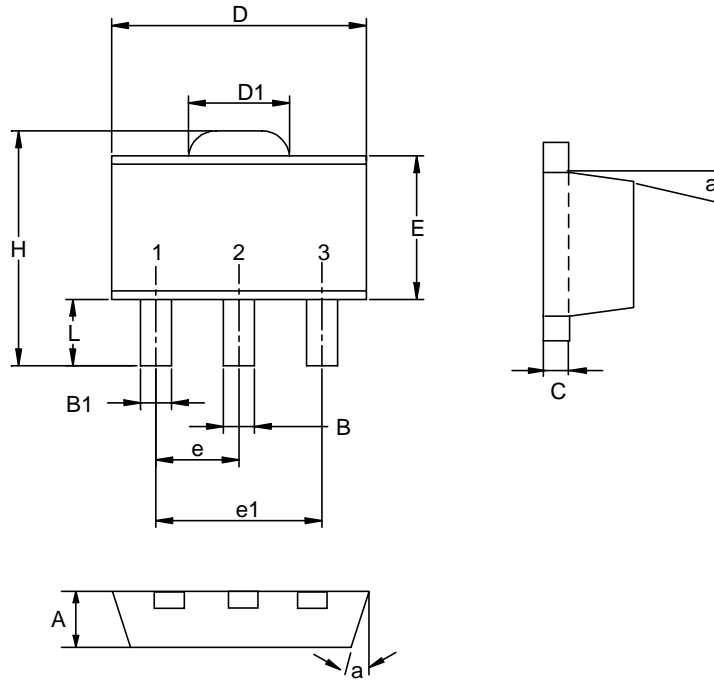

Dim	Millimeters		Inches	
	Min.	Max.	Min.	Max.
A	1.40	1.60	0.055	0.063
B	0.40	0.56	0.016	0.022
B1	0.35	0.48	0.014	0.019
C	0.35	0.44	0.014	0.017
D	4.40	4.60	0.173	0.181
D1	1.35	1.83	0.053	0.072
e	1.50 BSC		0.059 BSC	
e1	3.00 BSC		0.118 BSC	
E	2.29	2.60	0.090	0.102
H	3.75	4.25	0.148	0.167
L	0.80	1.20	0.031	0.047
α		10°		10°

## Package Information

SOT-223( Reference JEDEC Registration SOT-223)

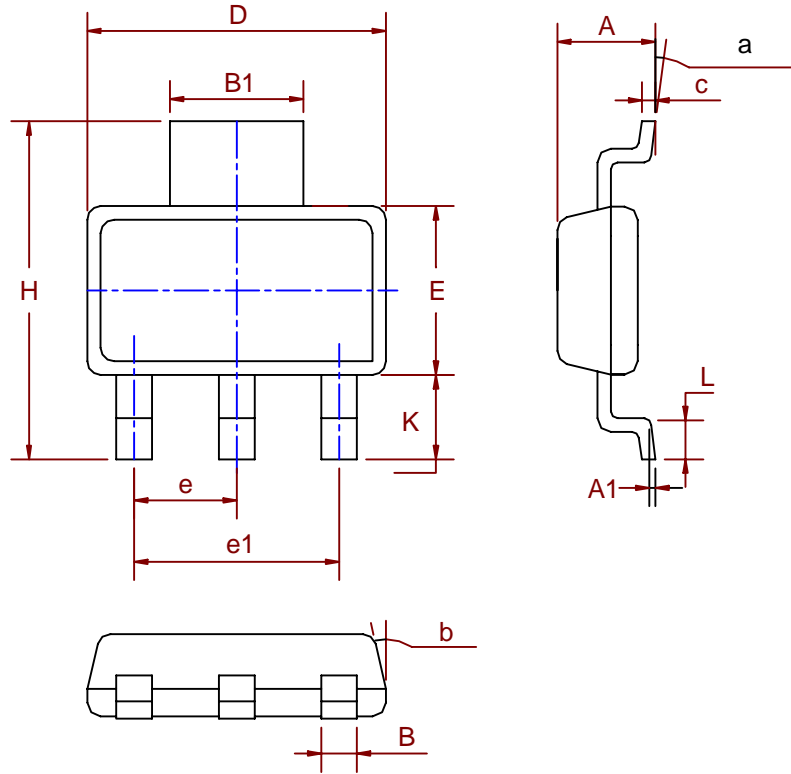

Dim	Millimeters		Inches	
	Min.	Max.	Min.	Max.
A	1.50	1.80	0.06	0.07
A1	0.02	0.08		
B	0.60	0.80	0.02	0.03
B1	2.90	3.10	0.11	0.12
c	0.28	0.32	0.01	0.01
D	6.30	6.70	0.25	0.26
E	3.30	3.70	0.13	0.15
e	2.3 BSC		0.09 BSC	
e1	4.6 BSC		0.18 BSC	
H	6.70	7.30	0.26	0.29
L	0.91	1.10	0.04	0.04
K	1.50	2.00	0.06	0.08
α	0°	10°	0°	10°
β	13°		13°	

## Physical Specifications

Terminal Material	Solder-Plated Copper (Solder Material : 90/10 or 63/37 SnPb), 100%Sn
Lead Solderability	Meets EIA Specification RSI86-91, ANSI/J-STD-002 Category 3.

### Reflow Condition (IR/Convection or VPR Reflow)

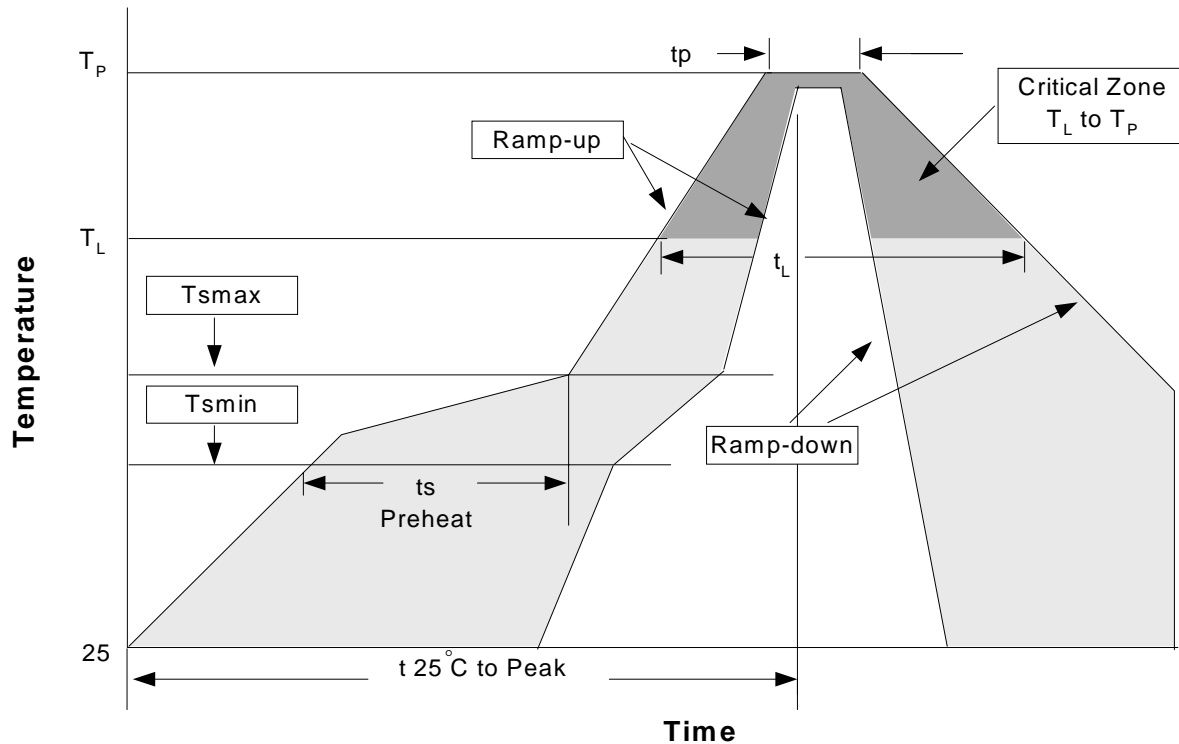

### Classification Reflow Profiles

Profile Feature	Sn-Pb Eutectic Assembly	Pb-Free Assembly
Average ramp-up rate ( $T_L$ to $T_P$ )	3°C/second max.	3°C/second max.
Preheat		
- Temperature Min ( $T_{smin}$ )	100°C	150°C
- Temperature Max ( $T_{smax}$ )	150°C	200°C
- Time (min to max) ( $t_s$ )	60-120 seconds	60-180 seconds
Time maintained above:		
- Temperature ( $T_L$ )	183°C	217°C
- Time ( $t_L$ )	60-150 seconds	60-150 seconds
Peak/Classification Temperature ( $T_p$ )	See table 1	See table 2
Time within 5°C of actual Peak Temperature ( $t_p$ )	10-30 seconds	20-40 seconds
Ramp-down Rate	6°C/second max.	6°C/second max.
Time 25°C to Peak Temperature	6 minutes max.	8 minutes max.

Notes: All temperatures refer to topside of the package .Measured on the body surface.

## Classification Reflow Profiles(Cont.)

Table 1. SnPb Eutectic Process – Package Peak Reflow Temperatures

Package Thickness	Volume mm <sup>3</sup> <350	Volume mm <sup>3</sup> ≥350
<2.5 mm	240 +0/-5°C	225 +0/-5°C
≥2.5 mm	225 +0/-5°C	225 +0/-5°C

Table 2. Pb-free Process – Package Classification Reflow Temperatures

Package Thickness	Volume mm <sup>3</sup> <350	Volume mm <sup>3</sup> 350-2000	Volume mm <sup>3</sup> >2000
<1.6 mm	260 +0°C*	260 +0°C*	260 +0°C*
1.6 mm – 2.5 mm	260 +0°C*	250 +0°C*	245 +0°C*
≥2.5 mm	250 +0°C*	245 +0°C*	245 +0°C*

\*Tolerance: The device manufacturer/supplier **shall** assure process compatibility up to and including the stated classification temperature (this means Peak reflow temperature +0°C. For example 260°C+0°C) at the rated MSL level.

## Reliability test program

Test item	Method	Description
SOLDERABILITY	MIL-STD-883D-2003	245°C , 5 SEC
HOLT	MIL-STD-883D-1005.7	1000 Hrs Bias @ 125 °C
PCT	JESD-22-B, A102	168 Hrs, 100 % RH , 121°C
TST	MIL-STD-883D-1011.9	-65°C ~ 150°C, 200 Cycles
ESD	MIL-STD-883D-3015.7	VHBM > 2KV, VMM > 200V
Latch-Up	JESD 78	10ms , I <sub>tr</sub> > 100mA

## Carrier Tape

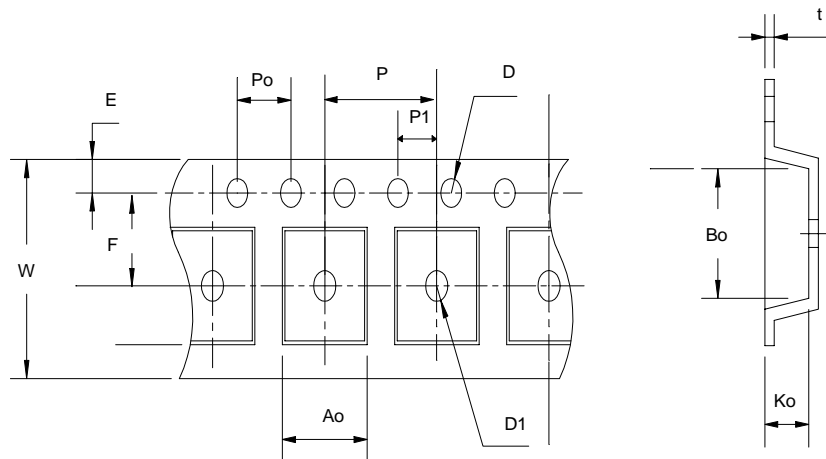

Carrier Tape(Cont.)

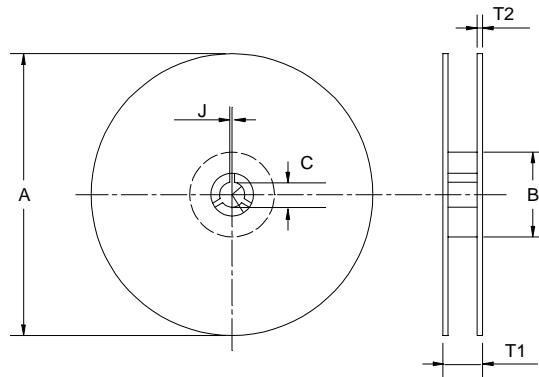

<b>Application</b>	A	B	C	J	T1	T2	W	P	E
<b>SOT-23</b>	178±1	60 ± 1.0	12.0	2.5 ± 0.15	9.0 ± 0.5	1.4	8.0 <sup>+0.3</sup> <sub>-0.3</sub>	4.0	1.75
	F	D	D1	Po	P1	Ao	Bo	Ko	t
	3.5 ± 0.05	1.5 +0.1	φ 0.1MIN	4.0	2.0 ± 0.05	3.1	3.0	1.3	0.2±0.03
<b>Application</b>	A	B	C	J	T1	T2	W	P	E
<b>SOT-89</b>	178 ± 1	70 ± 2	13.5 ± 0.15	3 ± 0.15	14 ± 2	1.3 ± 0.3	12 <sup>+0.3</sup> <sub>12 -0.1</sub>	8 ± 0.1	1.75± 0.1
	F	D	D1	Po	P1	Ao	Bo	Ko	t
	5.5 ± 0.05	1.5± 0.1	1.5± 0.1	4.0 ± 0.1	2.0 ± 0.1	4.8 ± 0.1	4.5± 0.1	1.80± 0.1	0.3±0.013
<b>Application</b>	A	B	C	J	T1	T2	W	P	E
<b>SOT-223</b>	330±1	62±1.5	12.75± 0.15	2 ± 0.6	12.4 +0.2	2± 0.2	12 ± 0.3	8 ± 0.1	1.75± 0.1
	F	D	D1	Po	P1	Ao	Bo	Ko	t
	5.5 ± 0.05	1.5+ 0.1	1.5+ 0.1	4.0 ± 0.1	2.0 ± 0.05	6.9 ± 0.1	7.5± 0.1	2.1± 0.1	0.3±0.05

(mm)

Cover Tape Dimensions

Application	Carrier Width	Cover Tape Width	Devices Per Reel
<b>SOT- 23</b>	8	5.3	3000
<b>SOT- 89</b>	12	9.3	1000
<b>SOT- 223</b>	12	9.3	2500

Customer Service

**Anpec Electronics Corp.**

Head Office :

5F, No. 2 Li-Hsin Road, SBIP,

Hsin-Chu, Taiwan, R.O.C.

Tel : 886-3-5642000

Fax : 886-3-5642050

Taipei Branch :

7F, No. 137, Lane 235, Pac Chiao Rd.,

Hsin Tien City, Taipei Hsien, Taiwan, R. O. C.

Tel : 886-2-89191368

Fax : 886-2-89191369