

Power Semiconductors

Power Modules

RF Power MOSFETs

# About Microsemi

---

Microsemi Corporation (Nasdaq: MSCC) offers a comprehensive portfolio of semiconductor and system solutions for communications, defense & security, aerospace and industrial markets. Products include high-performance, radiation-hardened and highly reliable analog mixed-signal integrated circuits, FPGAs, SoCs and ASICs; power management products; timing and voice processing devices; RF solutions; discrete components; security technologies and scalable anti-tamper products; Power-over-Ethernet ICs and midspans; as well as custom design capabilities and services.

Microsemi is headquartered in Aliso Viejo, Calif., and has approximately 3,000 employees globally. Learn more at [www.microsemi.com](http://www.microsemi.com).

## CONTENTS

	Page No.
<b>HIGH VOLTAGE SMPS TRANSISTORS</b>	
IGBTs (Insulated Gate Bipolar Transistors).....	3-5
Power MOS 8™ MOSFETs / FREDFETs .....	6-8
Ultra Low Gate Charge MOSFETs.....	9
COOLMOS™ MOSFETs.....	10
High Voltage Linear MOSFETs .....	10
<b>DIODES</b>	
SiC Schottky and Ultra Fast Recovery Diodes .....	11-13
<b>HIGH VOLTAGE RF MOSFETS.....</b>	<b>14</b>
<b>DRIVER-RF MOSFET HYBRIDS .....</b>	<b>14</b>
<b>HIGH FREQUENCY RF MOSFETS .....</b>	<b>15</b>
<b>REFERENCE DESIGN KIT .....</b>	<b>15</b>
<b>POWER MODULES</b>	
Contents.....	16
Electrical Configuration .....	17
Packaging.....	18
Know How and Capabilities .....	19-20
Part Numbering System .....	21
IGBTs (Insulated Gate Bipolar Transistors) .....	22-26
MOSFETs .....	27-31
Renewable Energy Power Modules .....	31-32
SiC Power Modules.....	33-35
Diodes and Rectifiers .....	36-38
<b>PACKAGE OUTLINE DRAWINGS.....</b>	<b>39-43</b>

# Insulated Gate Bipolar Transistors (IGBTs)

## IGBTs from Microsemi

IGBT products from Microsemi provide high quality solutions for a wide range of high voltage, high power applications. The switching frequency range spans from DC for minimal conduction loss to over 100kHz for very high power density SMPS applications. The frequency range for each product type is shown in the graph below. Each IGBT product represents the latest in IGBT technology, providing the best possible performance/cost combination for the targeted application. There are six product series that utilize three different IGBT technologies: Non-Punch-Through (NPT), Punch-Through (PT) and Field Stop.

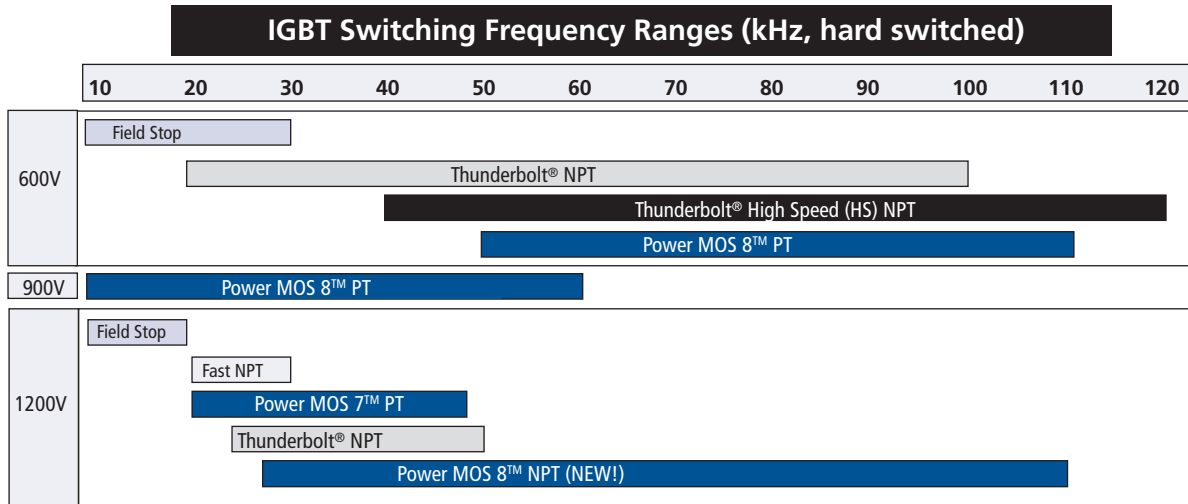

Note: Frequency ranges shown are typical for a 50A IGBT. Refer to product data sheet max frequency vs current graph for more information.

Standard Series	Voltage Ratings (V)	Technology	Easy to Parallel	Short Circuit SOA	Comment
Thunderbolt®	600, 1200	NPT	X	X	General purpose, high speed
Thunderbolt® High Speed	600	NPT	X	X	Highest speed
FAST	1200	NPT	X	X	General purpose, medium speed
MOS 7™	1200	PT			Ultra-low gate charge
MOS 8™	600, 900, 1200	PT, NPT			Highest efficiency
Field Stop Trench Gate	600, 1200	Field Stop	X	X	Lowest conduction loss

## Product Options

All standard IGBT products are available as a single IGBT or as a Combi product packaged with an anti-parallel DQ series diode. Package options include TO-220, TO-247, T-MAX®, TO-264, and SOT-227. Customized products are available; contact factory for details.

# Insulated Gate Bipolar Transistors (IGBTs)

## POWER MOS 8™

**New!**  
1200V

- NPT Technology
- High Speed Switching
- Low Switching Losses
- Easy to Parallel

## POWER MOS 8™

- PT Technology
- Fast Switching
- Highest Efficiency
- Combi with High Speed DQ Diode

## FIELD STOP

- Trench Technology
- Short Circuit Rated
- Lowest Conduction Loss
- Easy Paralleling
- Combi with High Speed DQ Diode

	BV <sub>CES</sub> Volts	V <sub>CE(ON)</sub> Typ 25°C	I <sub>C2</sub> 100°C	Maximum I <sub>C</sub> at Frequency		Part Number	Package Style
				50 kHz	80 kHz		
<b>POWER MOS 8™</b>	SINGLE	2.5	25	25	21	APT25GR120B	TO-247
				40	28	APT40GR120B	TO-247
				50	36	APT50GR120B2	T-MAX®
				25	42	APT70GR120B2	T-MAX®
				70	30	APT70GR120J	ISOTOP®
	85	46	APT85GR120L	TO-264			
					85*	31	APT85GR120J
	Combi (IGBT & Diode)	2.5	25	25			
					25	21	APT25GR120SD15
				25			
					25	21	APT25GR120SSCD10
				40			
					40	28	APT40GR120B2SCD10
25				32			
					70*	30	APT70GR120JD60
85*				31			
					<b>POWER MOS 8™</b>	SINGLE	2.0
26	20	APT44GA60B	TO-247				
				30			
35	27	APT68GA60B	TO-247				
				40			
51	39	APT102GA60B2	T-MAX® or TO-264				
				17			
21	13	APT43GA90B	TO-247				
				29			
34	23	APT80GA90B	TO-247 or D <sup>3</sup>				
				Combi (IGBT & "DQ" FRED)		2.0	36
26	20	APT44GA60BD30	TO-247				
48	36	APT60GA60JD60	ISOTOP®				
40	31	APT80GA60LD40	TO-264				
17	10	APT35GA90BD15	TO-247				
					21		
33	21	APT46GA90JD40	ISOTOP®				
				29	19	APT64GA90B2D30	T-MAX® or TO-264
34	23	APT80GA90LD40	TO-264				
				<b>FIELD STOP</b>	SINGLE	1.5	24
20	14	APT30GN60BG	TO-247				
42	30	APT75GN60BG	TO-247				
54	39	APT100GN60B2G	T-MAX®				
103	75	APT200GN60B2G	T-MAX®				
19	13	APT25GN120BG	TO-247 or D <sup>3</sup>				
					24	17	APT35GN120BG
32	22	APT50GN120B2G	T-MAX®				
					44	27	APT100GN120J
45	30	APT75GN120B2G	T-MAX® or TO-264				
					58	38	APT100GN120B2G
60	36	APT150GN120J	ISOTOP®				

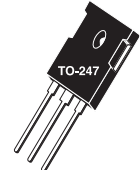

TO-247[B]



D<sup>3</sup> PAK[S]

Part Numbers for D<sup>3</sup> packages - replace "B" with "S" in part number



T-MAX®[B2]

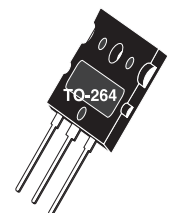

TO-264[L]

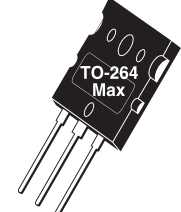

264-MAX™[L2]

Part Numbers for TO-264 packages - replace "B2" with "L" in part number

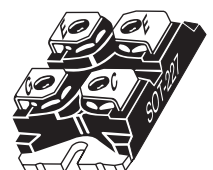

ISOTOP®[J]  
SOT-227

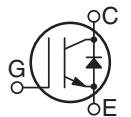

Current @ Frequency Test Conditions: T<sub>j</sub> = 125°C, T<sub>c</sub> = 100°C except Isotop® where T<sub>c</sub> = 80°C, V<sub>cc</sub> = 67% rated voltage Hard Switch

\* I<sub>c2</sub> for ISOTOP® packages measured at 70°C for 1200V NPT IGBTs

# Insulated Gate Bipolar Transistors (IGBTs)

	BV <sub>CES</sub> Volts	V <sub>CE(ON)</sub> Typ 25°C	I <sub>C2</sub> 100°C	Maximum I <sub>C</sub> at Frequency		Part Number	Package Style
				15 kHz	30 kHz		
<b>Combi (IGBT &amp; "DQ" FRED)</b>				15 kHz	30 kHz		
600	1.5	24	15	10	APT20GN60BDQ1G	TO-247	
	1.5	37	20	14	APT30GN60BDQ2G	TO-247	
	1.5	64	30	21	APT50GN60BDQ2G	TO-247	
	1.5	93	42	30	APT75GN60LDQ3G	TO-264	
	1.5	123	75	47	APT150GN60JDQ4	ISOTOP®	
	1.5	135	54	39	APT100GN60LDQ4G	TO-264	
	1.5	190	79	57	APT150GN60LDQ4G	TO-264	
1200	1.5	158	100	66	APT200GN60JDQ4	ISOTOP®	
			10 kHz	20 kHz			
	1.7	22	14	10	APT15GN120BDQ1G	TO-247 or D <sup>3</sup>	
	1.7	33	19	13	APT25GN120B2DQ2G	T-MAX®	
	1.7	46	24	17	APT35GN120L2DQ2G	264-MAX™	
	1.7	57	36	22	APT75GN120JDQ3	ISOTOP®	
	1.7	66	32	22	APT50GN120L2DQ2G	264-MAX™	
1200	1.7	70	44	27	APT100GN120JDQ4	ISOTOP®	
	1.7	99	60	36	APT150GN120JDQ4	ISOTOP®	
	<b>SINGLE</b>		20 kHz	40 kHz			
	1200	3.3	33	19	12	APT25GP120BG	TO-247
		3.3	46	24	15	APT35GP120BG	TO-247
		3.3	54	29	18	APT45GP120BG	TO-247
3.3		34	28	18	APT45GP120J	ISOTOP	
3.3		91	42	24	APT75GP120B2G	T-MAX™	
3.3	57	40	23	APT75GP120J	ISOTOP		
<b>Combi (IGBT &amp; "DQ" FRED)</b>				20 kHz	40 kHz		
1200	3.3	20	11	7	APT13GP120BDQ1G	TO-247	
	3.3	33	19	12	APT25GP120BDQ1G	TO-247	
	3.3	46	24	15	APT35GP120B2DQ2G	T-MAX™	
	3.3	54	29	18	APT45GP120B2DQ2G	T-MAX™	
	3.3	34	28	18	APT45GP120JDQ2	ISOTOP	
	3.3	57	40	23	APT75GP120JDQ3	ISOTOP	
<b>SINGLE</b>		30 kHz	60 kHz				
600	2.0	20	14	10	APT20GT60BRG	TO-247	
	2.0	30	19	13	APT30GT60BRG	TO-247	
	2.0	40	25	16	APT40GT60BRG	TO-247	
	2.0	50	30	20	APT50GT60BRG	TO-247	
	2.0	60	35	22	APT60GT60BRG	TO-247 or D <sup>3</sup>	
	2.0	100	56	35	APT100GT60B2RG	T-MAX® or TO-264	
	2.0	200	72	--	APT200GT60JR	ISOTOP®	
1200			20 kHz	40 kHz			
	3.2	18	11	8	APT15GT120BRG	TO-247	
	3.2	25	16	11	APT25GT120BRG	TO-247	
	3.2	50	27	17	APT50GT120B2RG	T-MAX® or TO-264	
	3.2	60	40	21	APT100GT120JR	ISOTOP®	
	3.2	90	52	25	APT150GT120JR	ISOTOP®	
<b>Combi (IGBT &amp; "DQ" FRED)</b>				30 kHz	60 kHz		
600	2.0	15	11	8	APT15GT60BRDQ1G	TO-247	
	2.0	20	14	10	APT20GT60BRDQ1G	TO-247	
	2.0	30	19	13	APT30GT60BRDQ2G	TO-247	
	2.0	50	30	20	APT50GT60BRDQ2G	TO-247 or D <sup>3</sup>	
	2.0	100	37	22	APT100GT60JRDQ4	ISOTOP®	
	1200			20 kHz	40 kHz		
3.2		18	11	8	APT15GT120BRDQ1G	TO-247	
3.2		25	16	11	APT25GT120BRDQ2G	TO-247	
3.2		50	27	17	APT50GT120B2RDQ2G	T-MAX® or TO-264	
3.2		42	34	19	APT75GT120JRDQ3	ISOTOP®	
3.2	60	40	21	APT100GT120JRDQ4	ISOTOP®		
<b>SINGLE</b>		50 kHz	80 kHz				
600	2.8	50	23	16	APT50GS60BRG	TO-247	
<b>Combi (IGBT &amp; "DQ" FRED)</b>				50 kHz	80 kHz		
600	2.8	30	14	9	APT30GS60BRDQ2G	TO-247	
	2.8	50	23	16	APT50GS60BRDQ2G	TO-247	
<b>SINGLE</b>		15 kHz	30 kHz				
1200	2.5	14	8	5	APT11GF120KRG	TO-220	
	2.5	20	11	7	APT20GF120KRG	TO-220	
	2.5	35	16	10	APT33GF120BRG	TO-247	
	2.5	75	27	17	APT50GF120B2RG	T-MAX®	
	2.5	75	27	17	APT50GF120LRG	TO-264	

## Power MOS 7® and IGBT

- PT Technology
- Ultra-low Gate Charge
- Combi with High Speed DQ Diode

## THUNDERBOLT®

- NPT Technology
- Short Circuit Rated
- Moderate to High Frequency
- Easy Paralleling

## THUNDERBOLT® HIGH SPEED

- High Speed Switching - Reduced Eoff
- Fastest Switching
- NPT Technology



TO-220[K]



D<sup>3</sup> PAK[S]

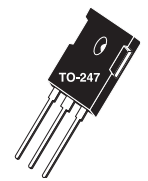

TO-247[B]

Part Numbers for D<sup>3</sup> packages - replace "B" with "S" in part number

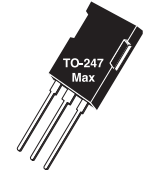

T-MAX®[B2]

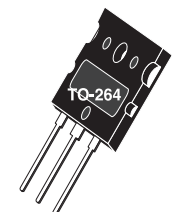

TO-264[L]

Part Numbers for L packages - replace "B2" with "L" in part number



ISOTOP®[J]  
SOT-227

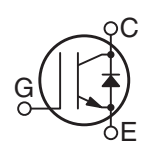

Current @ Frequency Test Conditions: T<sub>j</sub> = 125°C, T<sub>c</sub> = 100°C except Isotop® where T<sub>c</sub> = 80°C, V<sub>cc</sub> = 67% rated voltage Hard Switch

# Insulated Gate Bipolar Transistors (IGBTs)

## FAST

- NPT Technology
- Short Circuit Rated
- Low to Moderate Freq.
- Low Conduction Loss
- Easy Paralleling

BV <sub>CES</sub> Volts	V <sub>CE(ON)</sub> Typ 25°C	I <sub>C2</sub> 100°C	Maximum I <sub>c</sub> at Frequency		Part Number	Package Style
<b>Combi (IGBT &amp; "DQ" FRED)</b>						
1200	2.5	35	15 kHz	30 kHz	APT33GF120B2RDQ2G	T-MAX®
	2.5	64	16	10	APT50GF120JRDQ3	ISOTOP®
	2.5	80	33	17	APT60GF120JRDQ3	ISOTOP®
<b>Combi (IGBT &amp; "DL" FRED)</b>						
600	2.8	50	50 kHz	80 kHz	APT50GS60BRDLG	TO-247
	2.8	30	23	16	APT30GS60BRDLG	TO-247
	2.2	50	14	9	APT50GP60LDL	TO-264
	2.2	45	41	31	APT30GP60B2DL	T-MAX® or TO-264
	2.2	25	28	22	APT15GP60BDL	TO-247
1200	3.2	50	20 kHz	40 kHz	APT50GT120B2RDL	T-MAX®
	3.2	100	28	17	APT100GT120JRD	ISOTOP®



## Power MOS 8™ MOSFETs / FREDFETs (fast body diode)

Power MOS 8™ is Microsemi's latest family of high speed, high voltage (500-1200V) N-channel switch-mode power transistors with lower EMI characteristics and lower cost compared to previous generation devices. These new MOSFETs / FREDFETs have been optimized for both hard and soft switching in high frequency, high voltage applications rated above 500W. There are 2 product types in the Power MOS 8™ MOSFET family:



- 1) **MOSFET**
- 2) **FREDFETs** have a fast recovery body diode characteristic, providing high commutation dv/dt ruggedness and high reliability in ZVS circuits.

### Features

- Fast switching
- Low EMI
- Quiet switching
- Avalanche energy rated
- Low gate charge
- Lower cost

### Applications

- Power factor correction
- Server and telecom power systems
- Solar inverters
- Semiconductor capital equipment
- Induction heating
- Arc welding
- Plasma cutting
- Battery chargers
- Medical

### Quiet Switching

The new Power MOS 8™ series is a result of extensive research into quiet switching. Input and reverse transfer capacitance values as well as their ratio were set at specific values to achieve quiet switching with minimal switching loss. The Power MOS 8™ series of devices are inherently quiet switching, stable when connected in parallel, very efficient, and lower cost than previous generations.

### Body Diode Options

As with previous generation products, Power MOS 8™ MOSFETs and FREDFETs are available in all voltage ratings. A FREDFET is a MOSFET with a faster recovery intrinsic body diode. This results in improved reliability in ZVS circuits due to shorter minority carrier lifetime and increased commutation dv/dt ruggedness. If a fast recovery body diode is not needed, MOSFET versions are available.



# Power MOS 8™ MOSFETs / FREDFETs

$BV_{(DSS)}$ Volts	$R_{DS(ON)}$ Max	$I_D$	MOSFET Part #	$I_D$	FREDFET Part #	Package Style
1200	3.80	5	APT4M120K			TO-220
	4.20			4	APT4F120K	TO-220
	2.40			7	APT7F120B	TO-247 or D <sup>3</sup>
	2.10	8	APT7M120B			TO-247
	1.20			14	APT13F120B	TO-247 or D <sup>3</sup>
	1.10	14	APT14M120B			TO-247
	0.70			23	APT22F120B2	T-MAX® or TO-264
	0.63	24	APT24M120B2			T-MAX® or TO-264
	0.58			27	APT26F120B2	T-MAX® or TO-264
	0.58			18	APT17F120J	ISOTOP®
	0.53	29	APT28M120B2			T-MAX® or TO-264
	0.53	19	APT19M120J			ISOTOP®
	0.32			33	APT32F120J	ISOTOP®
	0.29	35	APT34M120J			ISOTOP®
1000	2.80			5	APT5F100K	TO-220
	2.50	6	APT6M100K			TO-220
	2.00			7	APT7F100B	TO-247
	1.80	8	APT8M100B			TO-247
	1.60			9	APT9F100B	TO-247 or D <sup>3</sup>
	1.40	9	APT9M100B			TO-247
	0.98			14	APT14F100B	TO-247 or D <sup>3</sup>
	0.88	14	APT14M100B			TO-247 or D <sup>3</sup>
	0.78			17	APT17F100B	TO-247 or D <sup>3</sup>
	0.70	18	APT18M100B			TO-247
	0.44			30	APT29F100B2	T-MAX® or TO-264
	0.44			20	APT19F100J	ISOTOP®
	0.38	32	APT31M100B2	35	APT34F100B2	T-MAX® or TO-264
	0.38	21	APT21M100J	23	APT22F100J	ISOTOP®
	0.33	37	APT37M100B2			T-MAX® or TO-264
	0.33	25	APT25M100J			ISOTOP®
	0.20			42	APT41F100J	ISOTOP®
0.18	45	APT45M100J			ISOTOP®	
800	1.50			7	APT7F80K	TO-220
	1.35	8	APT8M80K			TO-220
	0.90			12	APT11F80B	TO-247 or D <sup>3</sup>
	0.80	13	APT12M80B			TO-247
	0.58			18	APT17F80B	TO-247 or D <sup>3</sup>
	0.53	19	APT18M80B			TO-247 or D <sup>3</sup>
	0.43			23	APT22F80B	TO-247 or D <sup>3</sup>
	0.39	25	APT24M80B			TO-247 or D <sup>3</sup>
	0.24			41	APT38F80B2	T-MAX® or TO-264
	0.21	43	APT41M80B2	47	APT44F80B2	T-MAX® or TO-264
	0.21			31	APT29F80J	ISOTOP®
	0.19	49	APT48M80B2			T-MAX® or TO-264
	0.19	33	APT32M80J			ISOTOP®
	0.11			57	APT53F80J	ISOTOP®
	0.10	60	APT58M80J			ISOTOP®



TO-220[K]

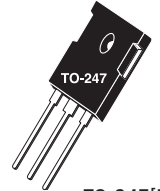

TO-247[B]



D<sup>3</sup> PAK[S]

Part Numbers for D<sup>3</sup> packages - replace "B" with "S" in part number

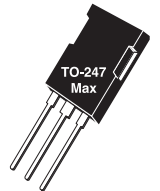

T-MAX®[B2]

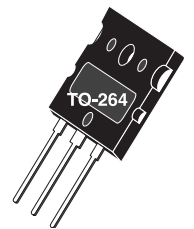

TO-264[L]

Part Numbers for TO-264 packages - replace "B2" with "L" in part number

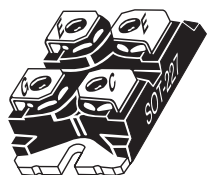

ISOTOP®[J]  
SOT-227  
(ISOLATED BASE)

# Power MOS 8<sup>TM</sup> MOSFETs / FREDFETs

BV <sub>(DSS)</sub> Volts	R <sub>DS(ON)</sub> Max	I <sub>D</sub>	MOSFET Part #	I <sub>D</sub>	FREDFET Part #	Package
600	0.62			12	APT12F60K	TO-220
	0.43			16	APT15F60B	TO-247 or D <sup>3</sup>
	0.37			19	APT18F60B	TO-247 or D <sup>3</sup>
	0.29			24	APT23F60B	TO-247 or D <sup>3</sup>
	0.22			30	APT28F60B	TO-247 or D <sup>3</sup>
	0.19	36	APT34M60B	36	APT34F60B	TO-247
	0.15	45	APT43M60B2	45	APT43F60B2	T-MAX® or TO-264
	0.15	31	APT30M60J	31	APT30F60J	ISOTOP®
	0.11	60	APT56M60B2	60	APT56F60B2	T-MAX® or TO-264
	0.11	42	APT39M60J	42	APT39F60J	ISOTOP®
	0.09	70	APT66M60B2	70	APT66F60B2	T-MAX® or TO-264
	0.09	49	APT47M60J	49	APT47F60J	ISOTOP®
0.055	84	APT80M60J	84	APT80F60J	ISOTOP®	
500	0.39			15	APT15F50K	TO-220[K] or TO-220[KF]*
	0.30			20	APT20F50B	TO-247 or D <sup>3</sup>
	0.24			24	APT24F50B	TO-247 or D <sup>3</sup>
	0.19			30	APT30F50B	TO-247 or D <sup>3</sup>
	0.15			37	APT37F50B	TO-247 or D <sup>3</sup>
	0.13			43	APT42F50B	TO-247 or D <sup>3</sup>
	0.10	56	APT56M50B2	56	APT56F50B2	T-MAX® or TO-264
	0.10	38	APT38M50J	38	APT38F50J	ISOTOP®
	0.075	75	APT75M50B2	75	APT75F50B2	T-MAX® or TO-264
	0.075	51	APT51M50J	51	APT51F50J	ISOTOP®
	0.062	84	APT84M50B2	84	APT84F50B2	T-MAX® or TO-264
	0.062	58	APT58M50J	58	APT58F50J	ISOTOP®
0.036	103	APT100M50J	103	APT100F50J	ISOTOP®	

\* Available on APT15F50K

# Low Voltage Power MOS V<sup>®</sup> MOSFETs / FREDFETs

300	0.085	40	APT30M85BVFRG	40	APT30M85BVFRG	TO-247
	0.070	48	APT30M70BVFRG	48	APT30M70BVFRG	TO-247 or D <sup>3</sup>
	0.040	70	APT30M40JVFRG	70	APT30M40JVFRG	ISOTOP®
	0.019	130	APT30M19JVFR	130	APT30M19JVFR	ISOTOP®
200	0.045	56	APT20M45BVFRG	56	APT20M45BVFRG	TO-247
	0.038	67	APT20M38BVFRG	37	APT20M38BVFRG	TO-247 or D <sup>3</sup> or T/R
	0.022	100	APT20M22B2VFRG	100	APT20M22B2VFRG	T-MAX® or TO-264
	0.011	175	APT20M11JVFR	175	APT20M11JVFR	ISOTOP®

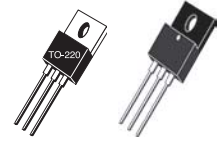

TO-220[K] or TO-220[KF]\*

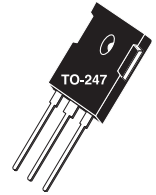

TO-247[B]



D<sup>3</sup> PAK[S]

Part Numbers for D<sup>3</sup> packages  
- replace "B" with "S" in part  
number

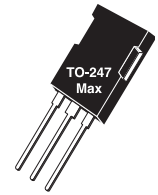

T-MAX®[B2]

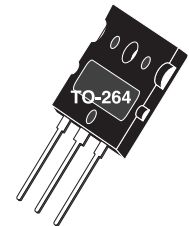

TO-264[L]

Part Numbers for TO-264  
packages - replace "B2" with  
"L" in part number

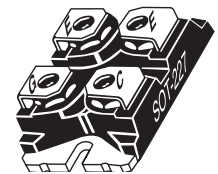

ISOTOP®[J]  
SOT-227  
(ISOLATED BASE)



# Ultrafast, Low Gate Charge MOSFETs

## FOR 250 kHz - 2 MHz SWITCHING APPLICATIONS

The Ultrafast, Low Gate Charge MOSFET family combines the lowest gate charge available in the industry with Microsemi's proprietary self-aligned aluminum metal gate structure. The result is a MOSFET capable of extremely fast switching speeds and very low switching losses. The metal gate structure and the layout of these chips provide an internal series gate resistance (EGR) an order of magnitude lower than competitive devices built with a polysilicon gate.

These devices are ideally suited for high frequency and pulsed high voltage applications.

### Typical Applications:

- Class D amplifiers up to 2 MHz
- High voltage pulsed DC
- AM transmitters
- Plasma deposition/etch

FEATURES:	BENEFITS:
• Series Gate Resistance (Rg) <0.1 ohm	• Fast switching, uniform signal propagation
• Tr and Tf times of <10ns	• Pulse power applications
• Industry's Lowest Gate Charge	• Fast switching, reduced gate drive power

BV <sub>(DSS)</sub> Volts	R <sub>DS(ON)</sub> Max	I <sub>D</sub>	MOSFET Part #	FREDFET Part #	Package Style
1200	4.700	3.5		APT1204R7KFLG	TO-220
	4.700	3.5		APT1204R7BFLG	TO-247 or D <sup>3</sup>
	1.400	9		APT1201R4BFLG	TO-247
	0.670	18	APT12067B2LLG		T-MAX®
	0.670	17	APT12067JLL		ISOTOP®
	0.570	22	APT12057B2LLG		T-MAX®
	0.570	19	APT12057JLL		ISOTOP®
1000	0.900	12	APT10090BLLG		TO-247
	0.780	14	APT10078BLLG		TO-247 or D <sup>3</sup>
	0.450	23	APT10045B2LLG		T-MAX® or TO-264
	0.450	21	APT10045JLL		ISOTOP®
	0.350	28	APT10035B2LLG		T-MAX®
	0.350	25	APT10035JLL		ISOTOP®
	0.260	38		APT10026L2FLLG	TO-264 MAX
	0.260	30	APT10026JLL	APT10026JFLL	ISOTOP®
	0.210	37	APT10021JLL	APT10021JFLL	ISOTOP®
	0.140	52	APT8014L2LLL	APT8014L2FLLG	TO-264 MAX
	0.110	51	APT8011JLL	APT8011JFLL	T-MAX™ or TO-264
800	0.200	38	APT8020B2LL		T-MAX®
	0.200	33	APT8020JLL		ISOTOP® or D <sup>3</sup> or T/R
500	0.140	35	APT5014BLLG		TO-247
	0.100	46	APT5010B2LLG	APT5010B2FLLG	T-MAX® or TO-264
	0.065	67	APT50M65B2LLG	APT50M65B2FLLG	T-MAX® or TO-264
	0.065	58	APT50M65JLLG	APT50M65JFLLG	ISOTOP®
	0.075	51	APT50M75JLL	APT50M75JFLL	ISOTOP®
	0.075	57	APT50M75B2LLG		T-MAX® or TO-264
	0.050	71	APT50M50JLL		ISOTOP®
	0.038	88	APT50M38JLL		ISOTOP®



T-MAX®[B2]

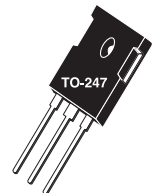

TO-247[B]

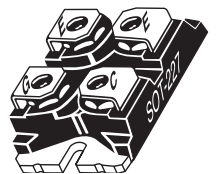

ISOTOP® [J]  
SOT-227  
(ISOLATED BASE)

BV <sub>DSS</sub> Volts	R <sub>DS(ON)</sub> Ohms	I <sub>D(Cont)</sub> Amps	Part Number	Package Style
<b>C3 TECHNOLOGY</b>				
900	0.120	36	APT36N90BC3G	TO-247
800	0.450	11	APT11N80KC3G	TO-220
	0.450	11	APT11N80BC3G	TO-247
	0.145	34	APT34N80B2C3G	T-MAX® or TO-264
650	0.145	34	APT34N80LC3G	TO-264
	0.035	94	APT94N65B2C3G	T-MAX® or TO-264
600	0.070	47	APT47N65BC3G	TO-247 or D <sup>3</sup>
	0.070	47	APT47N60BC3G	TO-247 or D <sup>3</sup>
	0.035	77	APT77N60JC3	ISOTOP®
	0.042	94	APT94N60L2C3G	264-MAX™
<b>SERVER SERIES</b>				
	0.045	60	APT60N60BCSG	TO-247 or D <sup>3</sup> or T/R
<b>NEW! C6 TECHNOLOGY</b>				
600	0.041	77	APT77N60BC6	TO-247 or D <sup>3</sup>
	0.070	53	APT53N60BC6	TO-247 or D <sup>3</sup>
	0.099	38	APT38N60BC6	TO-247 or D <sup>3</sup>
	0.125	30	APT30N60KC6	TO-220
	0.125	30	APT30N60BC6	TO-247 or D <sup>3</sup>
650	0.035	106	APT106N60B2C6	T-MAX™ or TO-264
	0.041	85	APT97N65B2C6	T-MAX™ or TO-264
	0.035	94	APT94N65B2C6	T-MAX™

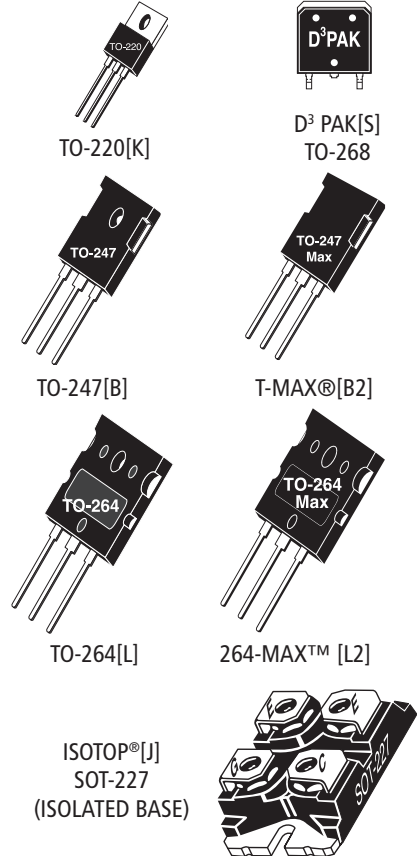

"COOLMOS" comprise a new family of transistors developed by Infineon Technologies AG.  
"COOLMOS" is a trademark of Infineon Technologies AG"

## Linear MOSFETs

### What is a Linear MOSFET?

A MOSFET specifically designed to be more robust than a standard MOSFET when operated with both high voltage and high current near DC conditions (>100msecs).

### The Problem with SMPS MOSFETs

MOSFETs optimized for high frequency SMPS applications have poor high voltage DC SOA. Most SMPS type MOSFETs over-state SOA capability at high voltage on the data sheets. Above ~30V and DC conditions, SOA drops faster than is indicated by P<sub>D</sub> limited operation.

For pulsed loads (<10ms) there is generally no problem using a standard MOSFET.

### Technology Innovation

Introduced in 1999, Microsemi modified its proprietary patented self-aligned metal gate MOSFET technology for enhanced performance in high voltage, linear applications. These Linear MOSFETs typically provide 1.5-2.0 times the DC SOA capability at high voltage compared to other MOSFET technologies optimized for switching applications.

### Designers will need Linear MOSFETs when...

- High Current & > 200V >100msec
- Used as a variable power resistor
- Soft start application (limit surge currents)
- Linear amplifier circuit

### Typical Applications...

- Active loads above 200 volts such as DC dynamic loads for testing power supplies, batteries, fuel cells, etc.
- High voltage, high current constant current sources.

BV <sub>DSS</sub> Volts	R <sub>DS(ON)</sub> Ohms	I <sub>D(Cont)</sub> Amps	SOA Watts	Part Number
1000	0.600	18	325	APL1001J
600	0.125	49	325	APL602B2G
	0.125	43	325	APL602J
500	0.090	58	325	APL502B2G
	0.090	52	325	APL502J

Part Numbers for TO-264 packages - replace "B2" with "L" in part number

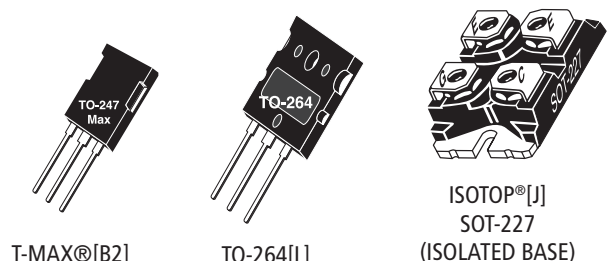

# Ultra Fast Recovery Diodes

Microsemi PPG offers five series of discrete diode products: a new DL series low  $V_F$  ultra-soft recovery, the medium speed medium  $V_F$  D series, the high speed DQ series, the very high speed DS series, and the silicon Schottky S series. These series of diodes are designed to provide high quality solutions to a wide range of high voltage, high power application requirements, ranging from fast recovery for continuous conduction mode power factor correction to low conduction loss for output rectification. Distinguishing features, technology used, and applications for each product family are summarized in the table below.

Series	Voltage Ratings	Features	Applications	Comment
DL	600	Low $V_F$ Ultra-soft recovery Avalanche Rated	Output rectifier Resonant circuits	Ultra-soft recovery minimizes or eliminates snubber
D	200, 300, 400, 600, 1000, 1200	Medium $V_F$ Medium Speed	Freewheeling Diode Output rectifier DC-DC converter	Proprietary platinum process
DQ	600, 1000, 1200	High speed Avalanche Rated	PFC Freewheeling Diode DC-DC converter	Stepped epi improves softness Proprietary platinum process
DS	600	Very high speed	High frequency PFC	Proprietary platinum process
Schottky	200	Low $V_F$ Avalanche rated	Output rectifier Freewheeling Diode DC-DC converter	

The graph below shows the relative recovery speed and forward voltage positions of 600V DL, D, DQ and DS series diodes.

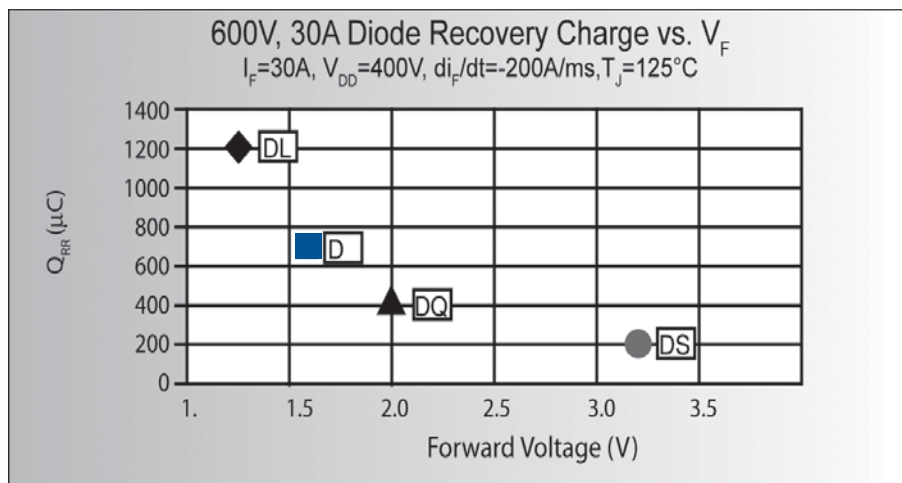

# SIC SCHOTTKY Diodes

**New!**

SIC SCHOTTKY DIODES					
Volts	$I_{F(avg)}$ Amps	$V_F$ volts Typ 25° C	Diode Series	Part Number	Package Style
<b>SINGLE</b>					
1200	10	1.5	SCD	APT10SCD120B	TO-247
	10	1.5	SCD	APT10SCD120K	TO-220
	20	1.5	SCD	APT20SCD120B	TO-247
	20	1.5	SCD	APT20SCD120S	D <sup>3</sup>
	30	1.5	SCD	APT30SCD120B	TO-247
	30	1.5	SCD	APT30SCD120S	D <sup>3</sup>
<b>DUAL</b>					
1200	10	1.5	SCD	APT10SCD120BCT	TO-247

# Ultra Fast Recovery Diodes

Volts	$I_{F(avg)}$ Amps	$V_F$ (volts) Typ 25°C	$t_{RR}$ (ns) Typ 25°C	$Q_{RR}$ (nC) Typ 125°C at $I_F = I_{F(avg)}$	Diode Series	Part Number	Package Style	
<b>SINGLE</b>								
1200	15	2.8	21	960	DQ	APT15DQ120BG	TO-247	
	15	2.8	21	960	DQ	APT15DQ120KG	TO-220	
	15	2.0	32	1300	D	APT15D120BG	TO-247	
	15	2.0	32	1300	D	APT15D120KG	TO-220	
	30	2.8	24	1800	DQ	APT30DQ120BG	TO-247	
	30	2.8	24	1800	DQ	APT30DQ120KG	TO-220	
	30	2.0	31	3450	D	APT30D120BG	TO-247	
	40	2.8	26	2200	DQ	APT40DQ120BG	TO-247	
	60	2.8	30	2800	DQ	APT60DQ120BG	TO-247	
	60	2.0	38	4000	D	APT60D120BG	TO-247 or D <sup>3</sup>	
1000	75	2.8	32	3340	DQ	APT75DQ120BG	TO-247	
	15	2.5	20	810	DQ	APT15DQ100BG	TO-247	
	15	2.5	20	810	DQ	APT15DQ100KG	TO-220	
	15	1.9	28	1550	D	APT15D100KG	TO-220	
	30	2.5	22	1250	DQ	APT30DQ100BG	TO-247	
	30	2.5	22	1250	DQ	APT30DQ100KG	TO-247	
	30	1.9	29	2350	D	APT30D100BG	TO-247	
	40	2.5	24	1430	DQ	APT40DQ100BG	TO-247	
	60	2.5	29	2325	DQ	APT60DQ100BG	TO-247	
	60	1.9	34	3600	D	APT60D100BG	TO-247 or D <sup>3</sup>	
600	75	2.5	33	2660	DQ	APT75DQ100BG	TO-247	
	15	2.0	16	250	DQ	APT15DQ60BG	TO-247	
	15	2.0	16	250	DQ	APT15DQ60KG	TO-220	
	15	1.6	21	520	D	APT15D60BG	TO-247	
	15	1.6	21	520	D	APT15D60KG	TO-220	
	30	2.0	19	400	DQ	APT30DQ60BG	TO-247	
	30	2.0	19	400	DQ	APT30DQ60KG	TO-220	
	30	1.6	23	700	D	APT30D60BG	TO-247	
	40	2.0	22	480	DQ	APT40DQ60BG	TO-247	
	60	2.0	26	640	DQ	APT60DQ60BG	TO-247	
400	60	1.6	40	920	D	APT60D60BG	TO-247 or D <sup>3</sup>	
	75	2.0	29	650	DQ	APT75DQ60BG	TO-247	
	100	1.25	45	3800	DL	APT100DL60BG	TO-247	
	30	1.3	22	360	D	APT30D40BG	TO-247	
	60	1.3	30	540	D	APT60D40BG	TO-247	
	200	30	1.1	21	150	D	APT30D20BG	TO-247
		30	0.83	25	448	Schottky	APT30S20BG	TO-247 or D <sup>3</sup>
		60	1.1	30	250	D	APT60D20BG	TO-247
		60	0.83	35	490	Schottky	APT60S20BG	TO-247 or D <sup>3</sup> or T/R
		100	0.89	40	690	Schottky	APT100S20BG	TO-247



TO-220[K]



D<sup>3</sup> PAK[S]  
TO-268

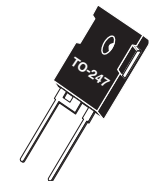

TO-247[B]

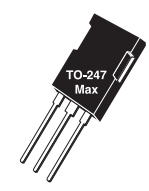

T-MAX®[B2]

## TANDEM, DS DIODES FOR PFC BOOST APPLICATIONS

600	15	3.2	13	85	DS	APT15DS60BG	TO-247
	30	3.2	17	180	DS	APT30DS60BG	TO-247

(2, 300V Diodes Connected In Series)

Part Numbers for D<sup>3</sup> packages - replace "B" with "S" in part number

# Ultra Fast Recovery Diodes

Volts	I <sub>F (avg)</sub> Amps	V <sub>F</sub> (volts) Typ 25°C	t <sub>RR</sub> (ns) Typ 25°C	Q <sub>RR</sub> (nC) Typ 125°C at I <sub>F</sub> = I <sub>F (avg)</sub>	Diode Series	Part Number	Package Style	
<b>DUAL</b>	2x27	2.0	31	3450	D	APT2X30D120J	ISOTOP®	
1200	2x30	2.6	25	1800	DQ	APT2X30DQ120J		
	2x53	2.0	38	4000	D	APT2X60D120J		
	2x60	2.5	30	2890	DQ	APT2X60DQ120J		
	2x93	2.0	47	5350	D	APT2X100D120J		
	2x100	2.4	45	5240	DQ	APT2X100DQ120J		
	1000	2x28	1.9	29	2350	D		APT2X30D100J
2x55		1.9	34	3600	D	APT2X60D100J		
2x60		2.2	30	2350	DQ	APT2X60DQ100J		
2x95		1.9	43	4050	D	APT2X100D100J		
2x100		2.1	45	3645	DQ	APT2X100DQ100J		
600	2x30	1.8	20	400	DQ	APT2X30DQ60J		
	2x30	1.6	23	700	D	APT2X30D60J		
	2x60	1.7	27	650	DQ	APT2X60DQ60J		
	2x60	1.6	40	920	D	APT2X60D60J		
	2x100	1.6	30	980	DQ	APT2X100DQ60J		
	2x100	1.6	34	1450	D	APT2X100D60J		
	2x150	1.25	53	3800	DL	APT2X150DL60J		
400	2x30	1.3	22	360	D	APT2X30D40J		
	2x60	1.3	30	540	D	APT2X60D40J		
	2x100	1.3	37	1050	D	APT2X100D40J		
	2x100	1.0	40	3550	DL	APT2X101DL40J <sup>++</sup>		
300	2x100	1.2	36	650	D	APT2X101D30J		
200	2x30	0.80	25	448	Schottky	APT2X31S20J		
	2x60	0.83	35	490	Schottky	APT2X61S20J		
	2x100	1.1	39	840	D	APT2X100D20J		
	2x100	0.89	40	690	Schottky	APT2X101S20J		
1200	2x30	2.8	26	2100	DQ	APT30DQ120BCTG		TO-247 [BCT]
1000	2x15	2.5	20	810	DQ	APT15DQ100BCTG		TO-247 [BCT]
	2x15	1.9	28	1550	D	APT15D100BCTG		TO-247 [BHB]
	2x30	1.9	29	2360	D	APT30D100BCTG		TO-247 [BHB]
	2x30	1.9	30	2350	D	APT30D100BHBG		TO-247 [BCA]
	2x60	2.5	29	2325	DQ	APT60DQ100LCTG		TO-264 [LCT]
	2x60	1.9	35	3600	D	APT60D100LCTG		TO-264 [LCT]
600	2x15	1.6	21	520	D	APT15D60BCTG		TO-247
	2x15	2.0	15	250	DQ	APT15DQ60BCTG		TO-247 [BCT]
	2x15	1.6	20	520	D	APT15D60BCAG		TO-247 [BCA]
	2x30	2.0	22	480	DQ	APT30DQ60BHBG		TO-247 [BHB]
	2x30	2.0	19	400	DQ	APT30DQ60BCTG		TO-247 [BCT]
	2x30	1.6	23	700	D	APT30D60BCTG		TO-247 [BCT]
	2x30	1.6	25	700	D	APT30D60BHBG		TO-247 [BHB]
	2x30	1.6	25	700	D	APT30D60BCAG		TO-247 [BCA]
	2x40	2.0	22	480	DQ	APT40DQ60BCTG		TO-247 [BCT]
	2x60	2.0	26	640	DQ	APT60DQ60BCTG		TO-247 [BCT]
2x60	1.6	30	920	D	APT60D60LCTG	TO-264 [LCT]		
400	2x30	1.3	22	360	D	APT30D40BCTG		TO-247 [BCT]
2x60	1.3	30	540	D	APT60D40LCTG	TO-264 [LCT]		
300	2x30	1.2	25	1300	D	APT30D30BCTG		TO-247 [BCT]
200	2x30	1.1	21	150	D	APT30D20BCTG	TO-247 [KCT]	
	2x30	1.1	21	150	D	APT30D20BCAG	TO-247 [BCA]	
	2x30	0.80	25	448	Schottky	APT30S20BCTG	TO-247 [BCT]	
	2x60	0.83	35	490	Schottky	APT60S20B2CTG	T-MAX® [B2CT]	
	2x100	0.89	40	690	Schottky	APT100S20LCTG	TO-264[LCT]	



ISOTOP®[J] SOT-227  
Antiparallel  
Configuration  
(ISOLATED BASE)

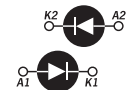

Part Numbers for Parallel Configuration replace 30, 60, or 100 with 31, 61, or 101. Except Schottky

Example: 2X30D120J becomes 2X31D120J

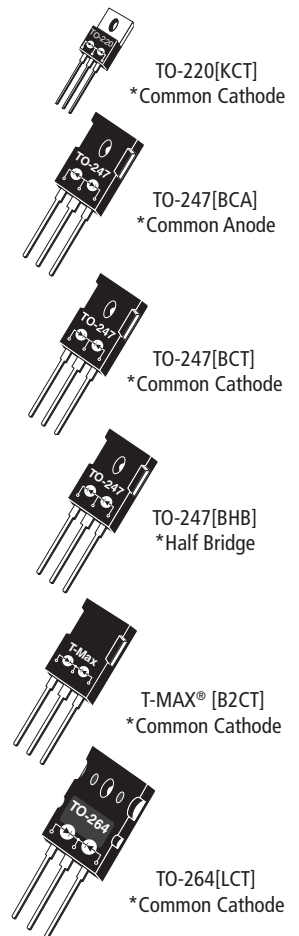

\*Current ratings per leg ++ Parallel Form Only

# High Voltage RF MOSFETs

The ARF family of RF Power MOSFETs are optimized for applications requiring frequencies as high as 150MHz and operating voltages as high as 400V. Historically, RF Power MOSFETs were limited to applications of 50V or less. This limitation has been removed by combining Microsemi's high voltage MOSFET technology with RF specific die geometries.

Why Higher Voltage? Higher  $V_{DD}$  means higher load impedance. For 150W output from a 50V supply the load impedance is only 8 ohms. At 125V, the load impedance is 50 ohms. The higher impedance allows simpler transformers and combiners. Paralleled devices can still operate into reasonable and convenient impedances. The increased operating voltage also lowers the DC current required for any given power output increasing efficiency and reducing the size, weight and cost of other system components.

Pout (W)	Freq. (MHz)	$V_{DD}/BV_{DSS}$ (V)	$\theta_{JC}$ ( $^{\circ}C/W$ )	Package Style	Part Number	Class of Operation
90	120	150V/450V	0.76	TO-247	ARF449AG/BG	C-E
100	100	125V/500V	0.70	TO-247	ARF463AG/BG	A-E
	100	125V/500V	0.70	TO-247	ARF463AP1G/BP1G	A-E
140	65	250V/900V	0.55	TO-247	ARF446G	C-E
	65	250V/900V	0.55	TO-247	ARF447G	C-E
	65	150V/450V	0.55	TO-247	ARF448AG/BG	C-E
150	65	125V/500V	0.50	TO-247	ARF460AG/BG	A-E
	65	250V/1kV	0.50	TO-247	ARF461AG/BG	A-E
	60	300V/1.2kV	0.50	TO-247	ARF465AG/BG	A-E
150	150	165V/500V	0.60	M174	ARF521	A-E
300	150	165V/500V	0.35	M208	ARF473	A-E
	150	165V/500V	0.31	T3A	ARF475FL	A-E
	150	165V/500V	0.31	T3C	ARF476FL	A-E
300	45	200V/1kV	0.35	TO-264	ARF466AG/BG	A-E
	45	200V/1kV	0.13	T3	ARF466FL	A-E
400	65	165V/500V	0.18	T3C	ARF477FL	A-E
750	25	250V/1000V	0.13	T2	ARF1519	A-E
750	40	125V/500V	0.12	T1	ARF1500	A-E
	40	250V/1kV	0.12	T1	ARF1501	A-E
	40	300V/1.2kV	0.12	T1	ARF1505	A-E
750	40	400V/1000V	0.12	T1	ARF1510	D
	40	380V/500V	0.12	T1	ARF1511	D

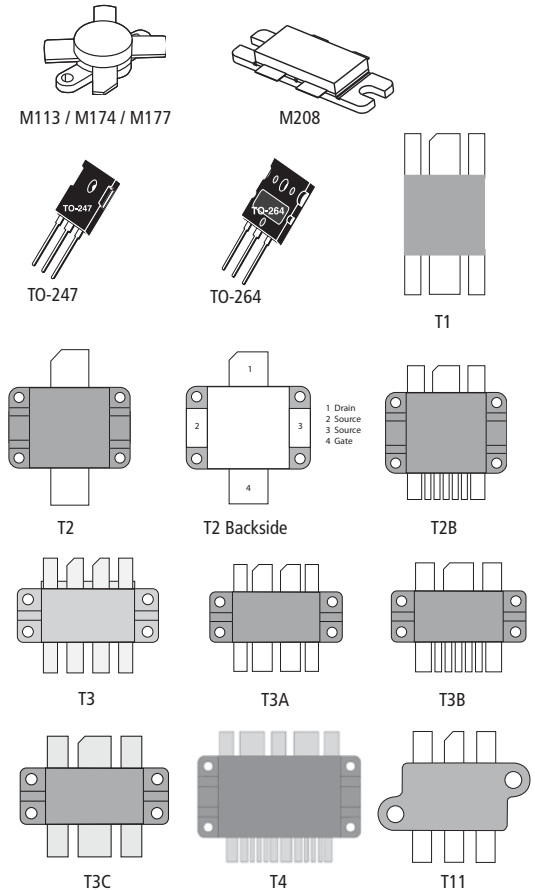

## Drivers and Driver-RF MOSFET Hybrids

The DRF1200/01/02/03 Hybrids integrates Driver, bypass capacitors and RF MOSFETs into a single package. Integration maximizes amplifier performance by minimizing transmission line parasitics between the Driver and MOSFET. The DRF1300 or DRF1301 has two independent channels, each containing a Driver and RF MOSFET in a push pull configuration. The DRF1400A and B are half bridge hybrids with symmetrically orientated leads so that the two can easily be configured into a full bridge converter. All DRF parts feature a proprietary Anti-ring function to eliminate cross conduction in a Bridge or push-pull topologies. All DRF parts can be externally selected in either an inverting or non-inverting configuration.

$P_D$ (W)	Freq. (MHz)	$V_{DD}/BV_{DSS}$ (V)	$\theta_{JC}$ ( $^{\circ}C/W$ )	Package Style	Part Number	Class of Operation	Description
600	30	15V/1000V	1.00	T2B	DRF1200	D-E	Driver and High Voltage RF MOSFET
1060	30	15V/1000V	.025	T2B	DRF1201	D-E	Driver and High Voltage/High Power RF MOSFET
1060	30	15V/500V	.025	T2B	DRF1202	D-E	Driver and High Power RF MOSFET
600	30	15V/1000V	0.09	T2B	DRF1203	D-E	Driver and High Voltage RF MOSFET
1000	30	15V/500V	0.06	T4	DRF1300	D-E	2 Drivers/RF MOSFETs in Push-Pull Configuration
1000	30	15V/1000	0.06	T4	DRF1301	D-E	2 Drivers/RF MOSFETs in Push-Pull Configuration
1500	30	15V/500	0.06	T4	DRF1400	D-E	2 Drivers/RF MOSFETs in a H Bridge Configuration



## High Frequency RF MOSFETs

The VRF family of RF MOSFETs are improved replacements for industry standard RF transistors. They provide improved ruggedness by increasing the  $BV_{DSS}$  over 30% from the industry standard of 125 volts to 170V minimum. Low cost flangeless packages are another improvement that show Microsemi's dedication to optimizing performance, reducing cost and improving reliability. We will continue to offer a greater number of product offerings in the new reduced-cost flangeless packages.

Pout Min (W)	Freq. (MHz)	Gain Typ (dB)	$\eta$ Typ (%)	$V_{DD}/BV_{DSS}$ (V)	Coss Typ (pF)	VSWR Load	$\theta_{JC}$ ( $^{\circ}C/W$ )	Case Style	Part Number
150	175	13	45	28V/80V	375	30:1	0.60	M174	VRF141
30	175	16	50	50V/170V	40	30:1	1.52	M113	VRF148A
150	150	11	50	50V/170V	210	30:1	0.60	M174	VRF150
150	175	14	50	50V/170V	200	30:1	0.60	M174	VRF151
300	175	14	55	28/80	375	5:1	0.35	M208	VRF141G
300	175	16	55	50V/170V	200	5:1	0.35	M208	VRF151G
150	175	14	50	50V/130V	215	30:1	0.60	M174	VRF152
600	30	17	45	50V/170V	775	-	0.13	T2	VRF154FL
600	30	21	45	50V/170V	810	-	0.13	T2	VRF157FL
300	30	21	50	50V/170V	400	3:1	0.27	M177	VRF2933

## Reference Design Kits

DRF1200/CLASS-E, 13.56 MHz

DRF1200/CLASS-E, 27.12 MHz

The DRF1200/CLASS-E Single Ended RF Generator is a reference design providing the designer the ability to evaluate an 85% efficient 1000W CLASS-E RF Generator

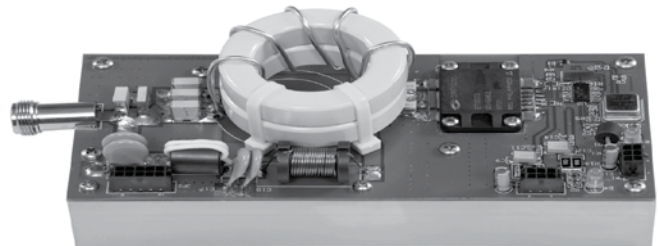

DRF1300/CLASS-D, 13.56 MHz

The DRF1300/CLASS-D Push Pull RF Generator is a reference design providing the designer the ability to evaluate an 80% efficient 2000W CLASS-D RF Generator

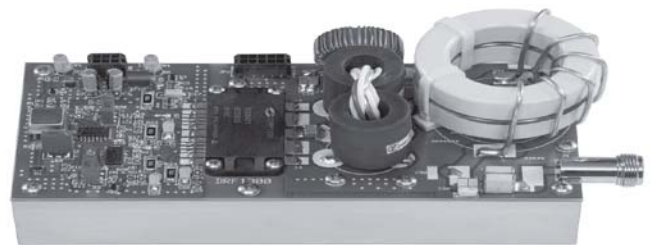

DRF1400/CLASS-D, 13.56 MHz

The DRF1400/CLASS-D Half Bridge RF Generator is a reference design providing the designer the ability to evaluate an 85% efficient 2500W CLASS-D RF Generator

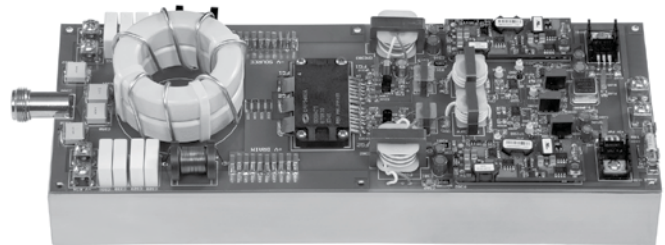

All kits include: A fully populated board attached to an aluminum heat sink. An extensive application note explaining the theory of operation with designers recommendations for evaluation and board layout. All key waveforms are illustrated and described. A complete parts list with recommended vendor part numbers and the board's Gerber file are provided for an easy transition into an end application.

# Power Modules Contents

## IGBT Power Modules

POWER MODULE INFORMATION	17-21
BOOST and BUCK CHOPPER	22-23
PHASE LEG	22-23
3 PHASE BRIDGE	23
PHASE LEG for welding application	24
TRIPLE PHASE LEG	24
TRIPLE DUAL COMMON SOURCE	24
INTERLEAVED PFC	24
DUAL CHOPPER	24
FULL & ASYMMETRICAL BRIDGE	25
SINGLE SWITCH	26
SINGLE SWITCH + SERIES DIODE	26
DUAL COMMON SOURCE	26

## Intelligent Power Modules

PHASE LEG	26
-----------	----

## MOSFET Power Modules

BOOST and BUCK CHOPPER	27
DUAL CHOPPER	27
FULL BRIDGE	28
FULL BRIDGE + SERIES AND PARALLEL DIODES	28
ASYMMETRICAL BRIDGE	28
PHASE LEG	29
PHASE LEG + SERIES AND PARALLEL DIODES	29
PHASE LEG + SERIES DIODES	29
TRIPLE PHASE LEG	29
TRIPLE DUAL COMMON SOURCE	30
DUAL COMMON SOURCE	30
SINGLE SWITCH	30
SINGLE SWITCH + SERIES DIODE	30
SINGLE SWITCH + SERIES AND PARALLEL DIODES	30
INTERLEAVED PFC	30
SINGLE AND DUAL LINEAR MOSFET	31

## RENEWABLE ENERGY Power Modules

FULL BRIDGE	31
PFC + BYPASS DIODE + PHASE LEG	31
PFC + FULL BRIDGE	31
PFC + BYPASS DIODE + FULL BRIDGE	31
SECONDARY FAST RECTIFIER + FULL BRIDGE	31
BOOST BUCK	32
3- LEVEL NPC INVERTER	32
T-TYPE 3-LEVEL INVERTER	32

## SiC Diode Power Modules

DUAL DIODE	33
FULL BRIDGE	33

## IGBT + SiC Diode Power Modules

BOOST CHOPPER	33
DUAL CHOPPER	33

## MOSFET + SiC Diode Power Modules

SINGLE SWITCH + SERIES FRED AND SiC PARALLEL DIODES	34
CHOPPER	34
DUAL CHOPPER	34
PHASE LEG + SERIES FRED AND SiC PARALLEL DIODES	34
FULL BRIDGE + SERIES FRED AND SiC PARALLEL DIODES	34
TRIPLE PHASE LEG	34

## SiC MOSFET Power Modules

PHASE LEG	35
T-TYPE 3-LEVEL INVERTER	35
3-LEVEL NPC INVERTER	35
BOOST CHOPPER	35

## Diode Power Modules

SINGLE DIODE	36
SINGLE DIODE - NON ISOLATED PACKAGE	36
3-PHASE BRIDGE	36
3-PHASE BRIDGE + THYRISTOR	36
FULL BRIDGE	37
THYRISTOR & DIODE DOUBLER	37
COMMON CATHODE - COMMON ANODE - DOUBLER	38

Package Outlines Drawings	40-43
---------------------------	-------

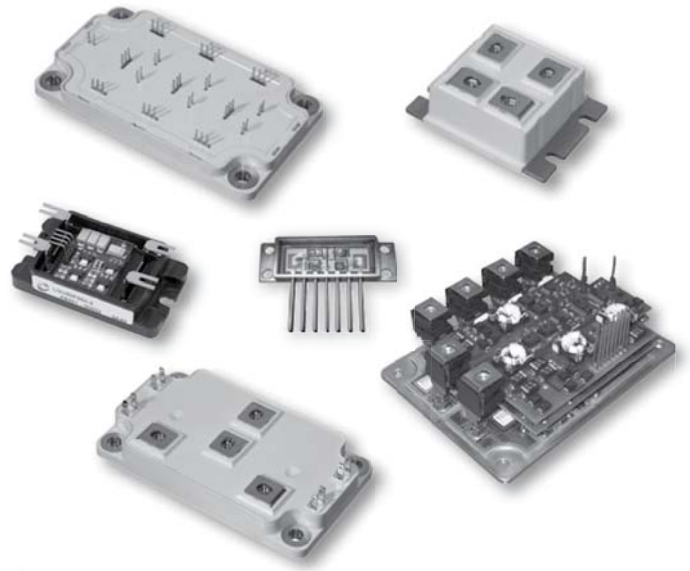

Microsemi combines a formidable array of technologies in semiconductors, packaging and automated manufacturing to produce a wide range of high quality modules optimized for:

- Reliability
- Efficiency and electrical performance
- Low cost
- Space savings
- Reduced assembly time

The readily available standard module product line spans a wide selection of circuit topologies, semiconductors including Silicon Carbide, voltage and current ratings and packages. If you need even more flexibility or intellectual property protection, Microsemi can often customize a standard module with low set up cost and with a short lead time. Unique requirements can be met with Application Specific Power Modules (ASPM®).

Microsemi serves a broad spectrum of industrial applications for Welding, Solar, Induction Heating, Medical, UPS, Motor Control and SMPS markets as well as HI-REL applications for Semicap, Defense and Aerospace markets. A wide selection of construction materials enables Microsemi to manufacture with short lead times modules that feature:

- Extended temperature range: -60°C to +200°C
- High reliability
- Reduced size and weight
- Hi-Rel testing and screening options

Microsemi's experience and expertise in power electronic conversion brings the most effective technical support for your new development.

- Isolated gate driver
- Snubbers
- Mix & match semiconductors
- Short circuit protection
- Temperature & current sensing
- Parameter binning

# Standard Electrical Configurations

Microsemi PMP offers a wide range of standard electrical configurations housed in various packages and capable to respond to many power conversion demands asking for high power density and performance. Same topology can be offered with different semiconductors type.

Electrical Topology	IGBT 600V to 1700V	MOSFET 75V to 1200V	Diode 30V to 1700V	Mix Si-SiC 600 & 1200V	Full SiC 600 & 1200V
Asymmetrical Bridge	X	X			
Boost Buck	X	X			
Boost & Buck Chopper	X	X		X	X
Common Anode			X		
Common Cathode			X		
Dual Boost & Buck Chopper	X	X		X	
Dual Common Source	X	X			
Dual Diode					X
Full Bridge	X	X	X		X
Full Bridge + PFC	X	X		X	
Full Bridge + Secondary Fast Rectifier Bridge	X	X		X	
Full Bridge + Series and Parallel Diodes		X		X	
Interleaved PFC	X	X			
Linear single and Dual switch		X			
Phase Leg	X	X	X		X
Phase Leg Intelligent	X				
Phase Leg + PFC		X		X	
Phase Leg + Series and Parallel Diodes		X		X	
Single Switch	X	X	X		
Single Switch + Series and Parallel Diodes		X		X	
Single Switch + Series Diodes	X	X			
3-Level NPC Inverter	X				X
3-Level T-Type Inverter	X			X	
3-Phase Bridge	X		X		
Triple Dual Common Source	X	X			
Triple Phase Leg	X	X		X	

NPT  
Trench3  
Trench4  
Trench4 Fast

MosFET  
FredFET  
CoolMOS

Schottky  
FRED  
Std Rectifier  
Thyristor

IGBT  
MosFET  
Diode

Diode  
MosFET

# Packaging

## Improved Low Profile Packages

- SP1 (12mm)
- SP3 (12mm)
- SP4 (17mm)
- SP6 (17mm)
- SP6-P (12mm)



## Industry Standard Packages

- SOT-227 (Isotop®)
- SP2 (17mm)
- 34mm & 62mm Types
  - D1 (34 mm Wide)
  - D3 (62 mm Wide)
  - D4 (62 mm Wide)



## Package Advantages

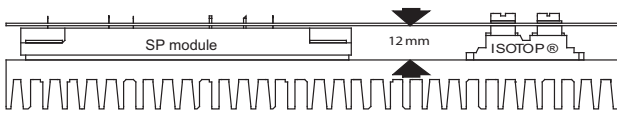

### SP1 package:

- Replaces 2 SOT-227 parts
- Improved assembly time and cost
- Height compatible with SOT-227
- Copper base plate



### SP3F package:

- Replaces up to 4 SOT-227 parts
- Reduced assembly time and cost
- Height compatible with SOT-227
- Copper base plate



30 mm



17 mm

### SP6 package:

- Offers the same footprint and the same pinout location as the popular 62mm package but with lower height, leading to:
  - Reduced stray inductance
  - Reduced parasitic resistance
  - Higher efficiency at high frequency



### SP6-P package:

- Replaces up to 6 SOT-227 parts
- Height compatible with SOT-227
- Low inductance solder pins
- High current capability

# Custom Power Modules

Microsemi PMP has created the Application Specific Power Module (ASPM) concept and has been offering customized power modules since 1983. Microsemi PMP offers a complete engineered solution with mix and match capabilities in term of package, configuration, performance and cost.

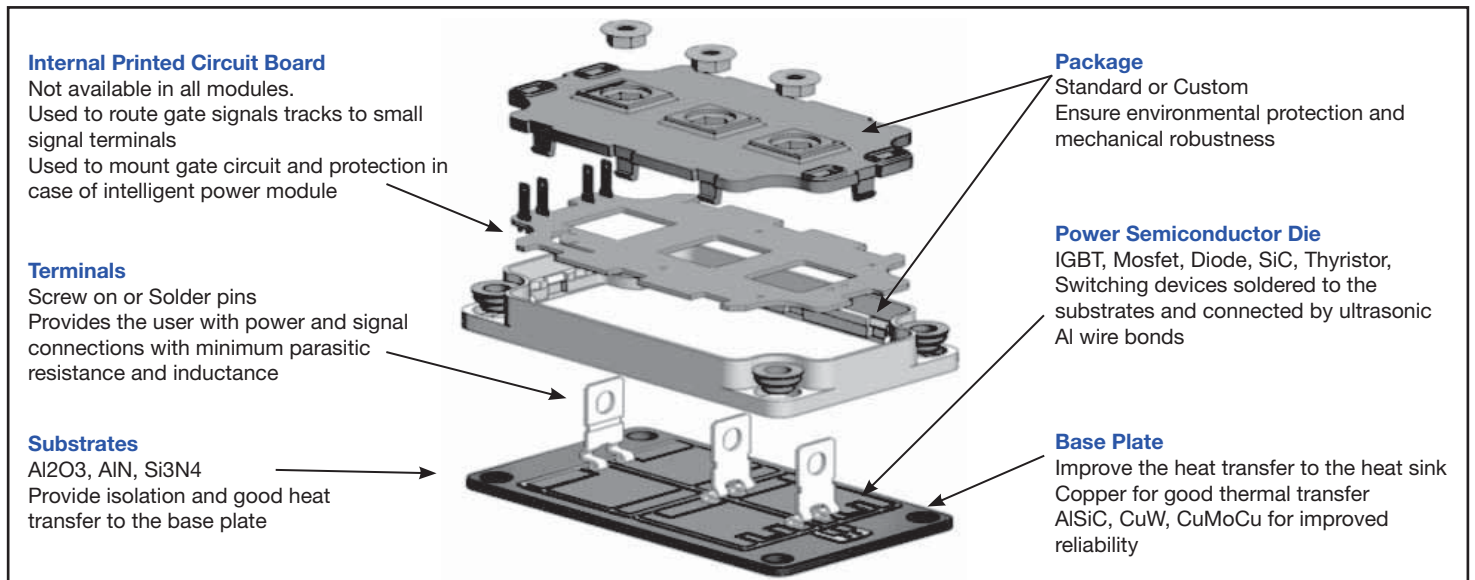

### 3 levels of customization are proposed offering different cost and low volume entry:

Change Options:	Die	Substrate	Base plate	Plastic lid	Terminals	NRE level	MOQ
Elect./thermal performance	Die P/N	Material	Material	-	-	None to low	5 to 10 pieces
Elect./thermal performance + electrical configuration	Die P/N	Material & Layout	Material	-	-	Low to medium	
Elect./thermal performance + electrical configuration + module housing	Die P/N	Material & Layout	Material & Shape	Material & Shape	Shape	Medium to high	

Microsemi PMP power modules are made of different sub-elements. Most of them are standard and can be re-used to build infinite solutions for the end user.

Microsemi PMP offers optimum development cost and cycle time thanks to long term experience and wide range of available technologies.

#### Power Modules Features

- High Power Density
- Isolated and highly thermally conductive substrate
- Internal wiring
- Minimum parasitics
- Minimum output terminals
- Mix & match components
- Full engineered solutions

#### Customer Benefits

- Size and cost reduction
- Excellent thermal management
- Reduced external hardware
- Improved performance
- Reduced assembly time
- Optimizes losses
- Easy upgrade/less parts counts/short time to market/IP protection

#### FLEXIBILITY

- Great level of integration
- Mix of Silicon within the same package
- No quantity limitation

#### PACKAGING CAPABILITY

- Standard and custom packages
- Standard and custom terminals
- Various substrate technologies

#### TECHNOLOGY

- Application oriented

#### RELIABILITY

- Coefficient of thermal expansion matching

#### APPLICATIONS

Solar - Welding - Plasma Cutting - Semicap - MRI & Xray - EV/HEV - Induction Heating - UPS - Motor control - Data Communication

# Rugged Custom Power Modules

Microsemi PMP has acquired a great experience and know-how in module customization to address rugged and wide temperature range application and offers solution to meet with next generation integrated power systems expectation in terms of:

- Improved Reliability
- Wider Operating Temperatures
- Higher Power
- Higher Efficiency
- Lower Weight and Size
- Lower Cost

## Applications

- Avionics actuation system
- Avionics lift and pump
- Military ground vehicle
- power supply and motor control
- Navy ship auxiliary power supply
- Down hole drilling

## Test Capabilities

- X-rays inspection
- Dielectric test (up to 6KV)
- Electrical testing at specified temperature
- Burn-in
- Acoustic imaging

## Reliability Testing Capabilities

- Power cycling
- Hermetic sealing
- Moisture
- Salt atmosphere
- HTGB
- Temperature shock
- HAST
- H3TRB
- Altitude
- Mechanical shock, vibration

## Expertise Capabilities

- Cross-sectioning
- Structural analysis

All tests can be conducted upon demand by sampling or at 100%. Tests performed in house or with external lab.

## Our Core Competencies

- Extensive experience of rugged solutions for harsh environments
- Wide range of Silicon technologies
- Wafer fab capabilities
- Mix of assembly technologies
- Hermetic and robust plastic packages
- Custom test & burn-in solutions
- ISO9001 certified
- End-of-life (obsolescence) management
- Thermal management
- Material expertise
- Product life management associated to risks analysis

Various solutions are proposed offering different cost and low volume of entry:

	Industrial Application	Extended Temperature Application	Harsh Environment Application	
Standard Module	X			No NRE Low Volume Entry
Modified Standard	X	X		Low NRE Low Volume Entry
Custom Module	X	X	X	Medium to High NRE Low Volume Entry

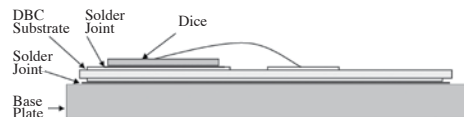

	CTE (ppm/K)	Thermal conductivity (W/m.K)	Rthjc (K/W)
Silicon Die (120 mm2)	4	136	
Cu/Al <sub>2</sub> O <sub>3</sub>	17/7	390/25	0.35
AlSiC/Al <sub>2</sub> O <sub>3</sub>	7/7	170/25	0.38
Cu/AlN	17/5	390/170	0.28
AlSiC/AlN	7/5	170/170	0.31
AlSiC/Si <sub>3</sub> N <sub>4</sub>	7/3	170/60	0.31

	Material	CTE (ppm/K)	Thermal conductivity (W/m.K)	Density (g/cc)
Base plate	CuW	6.5	190	17
	AlSiC	7	170	2.9
	Cu	17	390	8.9
Substrate	Al <sub>2</sub> O <sub>3</sub>	7	25	-
	AlN	5	170	-
	Si <sub>3</sub> N <sub>4</sub>	3	60	-
Die	Si	4	136	-
	SiC	2.6	270	-

## Module performance and reliability depends on the choice of the assembly materials

More closely matched materials TCE's increase the module life time because it will result in much less stress at the interface of the materials and inside the materials.

The higher the thermal conductivity, the lower is the junction to case thermal resistance and the lower will be the delta of junction temperature of the device during operation such that the effect of power cycling on the dice will be minimized.

Another important feature is the material density particularly for the baseplate. Taking copper as the reference, AlSiC has a density of 1/3 while Cuw has twice the density. Therefore AlSiC will provide substantial weight reduction at the same time as reliability increase.





# Power Module Part Numbering System

## IGBT Modules

APT	GL	475	A	120	T	D3	G
I	II	III	IV	V	VI	VII	VIII

I Trade Mark

II **IGBT Type:**  
**GF** = NPT or NPT FAST  
**GFQ** = NPT ULTRA FAST  
**GL** = TRENCH 4  
**GT** = TRENCH 3  
**GV** = Mix NPT/TRENCH  
**CV** = Mix TRENCH/CoolMOS

III **Current:**  
 Ic @ Tc=80°C

IV **Topology:**  
**A** = Phase Leg  
**BB** = Boost Buck  
**DA** = Boost Chopper  
**DDA** = Double Boost Chopper  
**DH** = Asymmetrical Bridge  
**DSK** = Double Buck Chopper  
**DU** = Dual Common Source  
**H** = Full Bridge  
**HR** = T-Type 3-Level  
**SDA** = Double Boost + Bypass Diode  
**SK** = Buck Chopper  
**TA** = Triple Phase Leg  
**TDU** = Triple Dual Common Source  
**TL** = Three Level  
**U** = Single Switch  
**VDA** = Interleaved PFC  
**X** = Three Phase Bridge

V **Blocking Voltage:**  
**60** = 600V  
**120** = 1200V  
**170** = 1700V

VI **Option:**  
**A** = AlN Substrate  
**C** = SiC Diode  
**D** = Series Diode  
**T** = Temperature Sensor  
**W** = Clamping Parallel Diode

VII **Package:**  
**1** = SP1  
**2** = SP2  
**3** = SP3  
**P** = SP6-P  
**D1** = D1 (34mm)  
**D3** = D3 (62mm)  
**D4** = D4 (62mm)

VIII **G** = RoHS Compliant

## MOSFET Modules

APT	C	60	DA	M24	T	1	G
I	II	III	IV	V	VI	VII	VIII

I Trade Mark

II **MOSFET Type:**  
**MC** = MOSFET SiC  
**M** = MOSFET  
**C** = CoolMOS

III **Blocking Voltage:**  
**08** = 75V                      **80** = 800V  
**10** = 100V                      **90** = 900V  
**20** = 200V                      **100** = 100V  
**50** = 500V                      **120** = 120V  
**60** = 600V

IV **Topology:**  
**A** = Phase Leg  
**BB** = Boost Buck  
**DA** = Boost Chopper  
**DDA** = Double Boost Chopper  
**DH** = Asymmetrical Bridge  
**DSK** = Double Buck Chopper  
**DU** = Dual Common Source  
**H** = Full Bridge  
**HR** = T-Type 3-Level  
**SDA** = Double Boost + Bypass Diode  
**SK** = Buck Chopper  
**TA** = Triple Phase Leg  
**TDU** = Triple Dual Common Source  
**TL** = Three Level NPC  
**U** = Single Switch  
**VDA** = Interleaved PFC

V **RDSON @ Tc=25°C**  
**240** = 2400mΩ  
**24** = 240mΩ  
**M24** = 24mΩ

VI **Option:**  
**A** = AlN Substrate  
**C** = SiC Diode  
**D** = Series Diode  
**F** = FREDFET  
**S** = Series and Parallel Diodes  
**T** = Temperature Sensor  
**U** = Ultrafast FREDFET

VII **Package:**  
**1** = SP1  
**2** = SP2  
**3** = SP3  
**P** = SP6-P

VIII **G** = RoHS Compliant

## Diode Modules

APT	DR	90	X	160	1	G
I	II	III	IV	V	VI	VII

I Trade Mark

II **Diode Type:**  
**DF** = FRED  
**DR** = Standard Rectifier  
**DC** = SiC  
**DSK** = Schottky

III **Current:**  
 IF @ Tc=80°C

IV **Topology:**  
**AA** = Dual Common Anode  
**BB** = Boost Buck  
**AK** = Dual Series  
**KK** = Dual Common Cathode  
**H** = Single Phase Bridge  
**U** = Single Switch  
**X** = Three Phase Bridge

V **Blocking Voltage:**  
**20** = 200V  
**40** = 400V  
**60** = 600V  
**100** = 1000V  
**120** = 1200V  
**160** = 1600V  
**170** = 1700V

VI **Package:**  
**1** = SP1  
**3** = SP3

VII **G** = RoHS Compliant

## Optional Materials

Optional materials are available upon demand on most of the listed standard power modules. Options are indicated with a letter in the suffix of the module part number. Temperature Sensor Option is indicated in the catalog with "YES" or "option" when available on standard part or on demand.

- A** AlN Substrate for higher thermal conductivity
- M** AlSiC Base plate material for improved temperature cycling capabilities
- T** Temperature Sensor (NTC or PTC) for Case Temperature information
- C** SiC Diode for higher efficiency
- N** Si3N4 Substrate
- E** Press fit terminals (for SP3 package only)

# IGBT Power Modules

## CHOPPER AND PHASE LEG

$V_{CES}$ (V)	IGBT Type	$I_C$ (A) $T_c=80^\circ\text{C}$	$V_{CE(on)}$ (V) at rated $I_C$	Package	NTC				
600	NPT	250	2.1	D3	option	APTGF250DA60D3G	APTGF250SK60D3G	APTGF250A60D3G	
		330	2.1	D3	option	APTGF330DA60D3G	APTGF330SK60D3G	APTGF330A60D3G	
	NPT FAST	30	2.1	SOT227	-	APT30GF60JU2	APT30GF60JU3	N/A	
		30	2.1	SP1	YES	N/A	N/A	APTGF30A60T1G	
		50	2.1	SOT227	-	APT50GF60JU2	APT50GF60JU3	N/A	
		60	2.1	SOT227	-	APT60GF60JU2	APT60GF60JU3	N/A	
		90	2.1	SP1	YES	APTGF90DA60T1G	APTGF90SK60T1G	APTGF90A60T1G	
		100	2.1	SOT227	-	APT100GF60JU2	APT100GF60JU3	N/A	
		150	2.1	SP3	YES	N/A	N/A	APTGF150A60T3AG	
		165	2.1	D1	-	APTGF165DA60D1G	APTGF165SK60D1G	APTGF165A60D1G	
		180	2.1	SP4	YES	APTGF180DA60TG	APTGF180SK60TG	APTGF180A60TG	
		350	2.1	SP6	option	APTGF350DA60G	APTGF350SK60G	APTGF350A60G	
	TRENCH3	75	1.5	SP1	YES	APTGT75DA60T1G	APTGT75SK60T1G	APTGT75A60T1G	
		100	1.5	SP1	YES	APTGT100DA60T1G	APTGT100SK60T1G	APTGT100A60T1G	
		100	1.5	SP2	-	N/A	N/A	APTGT100A602G	
		150	1.5	SP1	YES	APTGT150DA60T1G	APTGT150SK60T1G	APTGT150A60T1G	
		150	1.5	SP3	YES	N/A	N/A	APTGT150A60T3AG	
		200	1.5	SP2	-	N/A	N/A	APTGT200A602G	
		200	1.5	SP3	YES	APTGT200DA60T3AG	APTGT200SK60T3AG	APTGT200A60T3AG	
		300	1.5	SP4	YES	N/A	N/A	APTGT300A60TG	
		300	1.5	SP6	option	APTGT300DA60G	APTGT300SK60G	APTGT300A60G	
		300	1.5	D3	option	APTGT300DA60D3G	APTGT300SK60D3G	APTGT300A60D3G	
	650	TRENCH 4 FAST	100	1.85	SP1	YES	N/A	N/A	APTGLQ100A65T1G
			600	1.85	SP6	YES	N/A	N/A	APTGLQ600A65T6G
		NPT FAST	15	3.2	SP1	YES	N/A	N/A	APTGF15A120T1G
			50	3.2	SP1	YES	APTGF50DA120T1G	APTGF50SK120T1G	APTGF50A120T1G
			75	3.2	SP1	YES	APTGF75DA120T1G	N/A	N/A
			100	3.2	SP1	YES	APTGF100DA120T1G	N/A	N/A
100			3.2	SP2	-	N/A	N/A	APTGF100A1202G	
100			3.2	SP3	YES	N/A	N/A	APTGF100A120T3AG	
100			3.2	SP4	YES	APTGF100DA120TG	APTGF100SK120TG	APTGF100A120TG	
150			3.2	SP3	YES	N/A	N/A	APTGF150A120T3AG	
150	3.2		SP4	YES	APTGF150DA120TG	APTGF150SK120TG	APTGF150A120TG		
200	3.2		D3	option	N/A	N/A	APTGF200A120D3G		
1200	NPT FAST	300	3.2	SP6	option	APTGF300DA120G	APTGF300SK120G	APTGF300A120G	
		300	3.2	D3	option	APTGF300DA120D3G	APTGF300SK120D3G	APTGF300A120D3G	
		35	1.7	SP1	YES	N/A	N/A	APTGT35A120T1G	
		35	1.7	SOT227	-	APT35GT120JU2	APT35GT120JU3	N/A	
		50	1.7	SOT227	-	APT50GT120JU2	APT50GT120JU3	N/A	
	TRENCH 3	50	1.7	SP1	YES	N/A	N/A	APTGT50A120T1G	
		50	1.7	SP2	-	N/A	N/A	APTGT50A1202G	
		50	1.7	SP4	YES	APTGT50DA120TG	APTGT50SK120TG	N/A	
		75	1.7	SOT227	-	APT75GT120JU2	APT75GT120JU3	N/A	
		75	1.7	SP1	YES	N/A	N/A	APTGT75A120T1G	

NEW!  
NEW!

continued next page

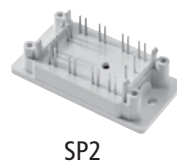

# IGBT Power Modules

## CHOPPER AND PHASE LEG CONT.

$V_{CES}$ (V)	IGBT Type	$I_c$ (A) $T_c=80^\circ\text{C}$	$V_{CE(on)}$ (V) at rated $I_c$	Package	NTC			
1200	TRENCH 3	75	1.7	SP2	-	N/A	N/A	APTGT75A1202G
		75	1.7	SP4	YES	APTGT75DA120TG	APTGT75SK120TG	N/A
		100	1.7	SP1	YES	APTGT100DA120T1G	N/A	N/A
		100	1.7	SOT227	-	APT100GT120JU2	APT100GT120JU3	N/A
		100	1.7	D1	-	N/A	N/A	APTGT100A120D1G
		100	1.7	SP2	-	N/A	N/A	APTGT100A1202G
		100	1.7	SP3	YES	N/A	N/A	APTGT100A120T3AG
		100	1.7	SP4	YES	N/A	N/A	APTGT100A120TG
		150	1.7	SP6	option	APTGT150DA120G	APTGT150SK120G	APTGT150A120G
		150	1.7	D1	-	APTGT150DA120D1G	APTGT150SK120D1G	APTGT150A120D1G
		150	1.7	SP2	-	N/A	N/A	APTGT150A1202G
		150	1.7	SP3	YES	N/A	N/A	APTGT150A120T3AG
		150	1.7	SP4	YES	N/A	N/A	APTGT150A120TG
		200	1.7	SP6	option	APTGT200DA120G	APTGT200SK120G	APTGT200A120G
		200	1.7	D3	option	APTGT200DA120D3G	APTGT200SK120D3G	APTGT200A120D3G
		300	1.7	SP6	option	APTGT300DA120G	APTGT300SK120G	APTGT300A120G
		300	1.7	D3	option	APTGT300DA120D3G	APTGT300SK120D3G	APTGT300A120D3G
		400	1.7	SP6	option	APTGT400DA120G	APTGT400SK120G	APTGT400A120G
	400	1.7	D3	option	N/A	N/A	APTGT400A120D3G	
	TRENCH 4	40	1.85	SOT227	-	APT40GL120JU2	APT40GL120JU3	N/A
		90	1.85	SP1	YES	APTGL90DA120T1G	APTGL90SK120T1G	APTGL90A120T1G
		180	1.85	SP2	-	N/A	N/A	APTGL180A1202G
		180	1.85	SP3	YES	N/A	N/A	APTGL180A120T3AG
		325	1.85	D3	option	APTGL325DA120D3G	APTGL325SK120D3G	APTGL325A120D3G
475		1.85	D3	option	APTGL475DA120D3G	APTGL475SK120D3G	APTGL475A120D3G	
TRENCH 4 FAST	100	2.05	SP3	YES	N/A	N/A	APTGLQ100A120T3AG	
	400	2.05	SP6	YES	N/A	N/A	APTGLQ400A120T6G	
1700	TRENCH 3	30	2.0	SP1	YES	APTGT30DA170T1G	APTGT30SK170T1G	APTGT30A170T1G
		50	2.0	SP1	YES	APTGT50DA170T1G	APTGT50SK170T1G	APTGT50A170T1G
		50	2.0	SP4	YES	APTGT50DA170TG	APTGT50SK170TG	APTGT50A170TG
		75	2.0	SP1	YES	APTGT75DA170T1G	N/A	N/A
		75	2.0	D1	-	APTGT75DA170D1G	APTGT75SK170D1G	APTGT75A170D1G
		100	2.0	SP4	YES	APTGT100DA170TG	APTGT100SK170TG	APTGT100A170TG
		150	2.0	SP6	option	APTGT150DA170G	APTGT150SK170G	APTGT150A170G
		200	2.0	D3	option	APTGT200DA170D3G	APTGT200SK170D3G	APTGT200A170D3G
		225	2.0	SP6	option	APTGT225DA170G	APTGT225SK170G	APTGT225A170G
		300	2.0	SP6	option	APTGT300DA170G	APTGT300SK170G	APTGT300A170G
		300	2.0	D3	option	APTGT300DA170D3G	APTGT300SK170D3G	APTGT300A170D3G

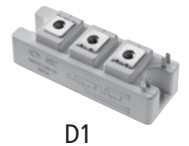

NEW!  
NEW!

## 3 PHASE BRIDGE

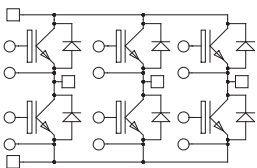

$V_{CES}$ (V)	IGBT Type	$I_c$ (A) $T_c=80^\circ\text{C}$	$V_{CE(on)}$ (V) at rated $I_c$	Package	NTC	Part Number
600	NPT FAST	30	2.1	SP3	YES	APTGF30X60T3G
		50	2.1	SP3	YES	APTGF50X60T3G
	TRENCH 3	30	1.5	SP3	YES	APTGT30X60T3G
		50	1.5	SP3	YES	APTGT50X60T3G
	TRENCH 3	75	1.5	SP3	YES	APTGT75X60T3G
		15	3.2	SP3	YES	APTGF15X120T3G
1200	NPT FAST	25	3.2	SP3	YES	APTGF25X120T3G
		25	1.7	SP3	YES	APTGT25X120T3G
	TRENCH 3	35	1.7	SP3	YES	APTGT35X120T3G
		40	1.85	SP3	YES	APTGL40X120T3G

# IGBT Power Modules

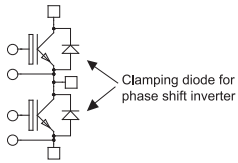

## PHASE LEG FOR WELDING APPLICATION

$V_{CES}$ (V)	IGBT Type	$I_C$ (A) $T_c=80^\circ\text{C}$	$V_{CE(on)}$ (V) at rated $I_C$	Package	NTC	Part Number
1200	NPT FAST	100	3.2	SP3	YES	APTGF100A120T3WG
		150	3.2	SP3	YES	APTGF150A120T3WG



SP3

## TRIPLE PHASE LEG

$V_{CES}$ (V)	IGBT Type	$I_C$ (A) $T_c=80^\circ\text{C}$	$V_{CE(on)}$ (V) at rated $I_C$	Package	NTC	Part Number
600	NPT FAST	90	2.1	SP6-P	option	APTGF90TA60PG
		50	1.5	SP6-P	option	APTGT50TA60PG
	TRENCH 3	75	1.5	SP6-P	option	APTGT75TA60PG
		150	1.5	SP6-P	option	APTGT150TA60PG
1200	NPT FAST	50	3.2	SP6-P	option	APTGF50TA120PG
		75	1.7	SP6-P	option	APTGT75TA120PG
	TRENCH 3	100	1.7	SP6-P	YES	APTGT100TA120TPG
		120	1.85	SP6-P	YES	APTGL120TA120TPG

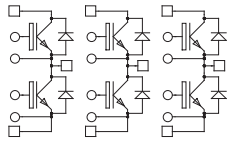

SP4

## TRIPLE DUAL COMMON SOURCE

$V_{CES}$ (V)	IGBT Type	$I_C$ (A) $T_c=80^\circ\text{C}$	$V_{CE(on)}$ (V) at rated $I_C$	Package	NTC	Part Number
600	TRENCH 3	50	1.5	SP6-P	option	APTGT50TDU60PG
		75	1.5	SP6-P	option	APTGT75TDU60PG
		100	1.5	SP6-P	option	APTGT100TDU60PG
		150	1.5	SP6-P	option	APTGT150TDU60PG
1200	TRENCH 3	50	3.2	SP6-P	option	APTGF50TDU120PG
		75	1.7	SP6-P	option	APTGT75TDU120PG
		120	1.85	SP6-P	YES	APTGL120TDU120TPG
1700	TRENCH 3	50	2.0	SP6-P	option	APTGT50TDU170PG

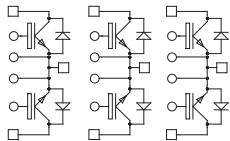

SP6-P

## INTERLEAVED PFC

$V_{CES}$ (V)	IGBT Type	$I_C$ (A) $T_c=80^\circ\text{C}$	$V_{CE(on)}$ (V) at rated $I_C$	Package	NTC	Part Number
600	NPT FAST	50	2.1	SP3	YES	APTGF50VDA60T3G
1200		50	3.2	SP3	YES	APTGF50VDA120T3G

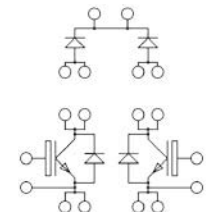

## DUAL CHOPPER

$V_{CES}$ (V)	IGBT Type	$I_C$ (A) $T_c=80^\circ\text{C}$	$V_{CE(on)}$ (V) at rated $I_C$	Package	NTC	...DDA...	...DSK...
600	NPT FAST	50	2.1	SP3	YES	APTGF50DDA60T3G	APTGF50DSK60T3G
		75	1.5	SP3	YES	APTGT50DDA60T3G	APTGT50DSK60T3G
	TRENCH 3	75	1.5	SP3	YES	APTGT75DDA60T3G	APTGT75DSK60T3G
1200	NPT FAST	25	3.2	SP3	YES	APTGF25DDA120T3G	APTGF25DSK120T3G
		50	3.2	SP3	YES	APTGF50DDA120T3G	APTGF50DSK120T3G
		75	3.2	SP4	YES	APTGF75DDA120TG	APTGF75DSK120TG
	TRENCH 3	50	1.7	SP3	YES	APTGT50DDA120T3G	APTGT50DSK120T3G
		60	1.85	SP3	YES	APTGL60DDA120T3G	APTGL60DSK120T3G
		90	1.85	SP3	YES	APTGL90DDA120T3G	APTGL90DSK120T3G

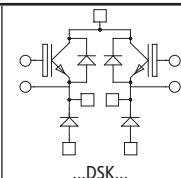
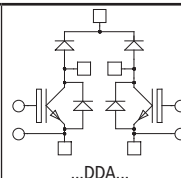

# IGBT Power Modules

## FULL & ASYMMETRICAL BRIDGE

$V_{CES}$ (V)	IGBT Type	$I_c$ (A) $T_c=80^\circ\text{C}$	$V_{CE(on)}$ (V) at rated $I_c$	Package	NTC		
600	NPT FAST	30	2.1	SP1	YES	APTGF30H60T1G	N/A
		30	2.1	SP3	YES	APTGF30H60T3G	N/A
		50	2.1	SP1	YES	APTGF50H60T1G	APTGF50DH60T1G
		50	2.1	SP2	YES	APTGF50H60T2G	N/A
		50	2.1	SP3	YES	APTGF50H60T3G	N/A
		90	2.1	SP3	YES	APTGF90H60T3G	APTGF90DH60T3G
	180	2.1	SP6	-	APTGF180H60G	APTGF180DH60G	
	TRENCH 3	20	1.5	SP1	YES	APTGT20H60T1G	N/A
		30	1.5	SP1	YES	APTGT30H60T1G	N/A
		50	1.5	SP1	YES	APTGT50H60T1G	APTGT50DH60T1G
		50	1.5	SP2	YES	APTGT50H60T2G	N/A
		50	1.5	SP3	YES	APTGT50H60T3G	N/A
		75	1.5	SP1	YES	APTGT75H60T1G	APTGT75DH60T1G
		75	1.5	SP2	YES	APTGT75H60T2G	N/A
		75	1.5	SP3	YES	APTGT75H60T3G	N/A
		100	1.5	SP4	YES	APTGT100H60TG	APTGT100DH60TG
		100	1.5	SP3	YES	APTGT100H60T3G	APTGT100DH60T3G
		150	1.5	SP4	YES	APTGT150H60TG	APTGT150DH60TG
200		1.5	SP6	-	APTGT200H60G	APTGT200DH60G	
300	1.5	SP6	-	APTGT300H60G	APTGT300DH60G		
650	TRENCH 4 FAST	75	1.85	SP1	YES	APTGLQ75H65T1G	N/A
		300	1.85	SP6	option	APTGLQ300H65G	N/A
1200	NPT ULTRA FAST	25	2.1	SP2	YES	APTGFQ25H120T2G	N/A
	NPT FAST	15	3.2	SP1	YES	APTGF15H120T1G	N/A
		25	3.2	SP1	YES	APTGF25H120T1G	N/A
		25	2.1	SP2	YES	APTGF25H120T2G	N/A
		25	3.2	SP3	YES	APTGF25H120T3G	N/A
		50	3.2	SP3	YES	N/A	APTGF50DH120T3G
		50	3.2	SP4	YES	APTGF50H120TG	APTGF50DH120TG
		75	3.2	SP4	YES	APTGF75H120TG	APTGF75DH120TG
	150	3.2	SP6	-	APTGF150H120G	APTGF150DH120G	
	TRENCH 3	35	1.7	SP3	YES	APTGT35H120T3G	N/A
		50	1.7	SP3	YES	N/A	APTGT50DH120T3G
		50	1.7	SP4	YES	APTGT50H120TG	APTGT50DH120TG
		50	1.7	SP3	YES	APTGT50H120T3G	N/A
		75	1.7	SP3	YES	N/A	APTGT75DH120T3G
		75	1.7	SP4	YES	APTGT75H120TG	APTGT75DH120TG
		100	1.7	SP4	YES	N/A	APTGT100DH120TG
		100	1.7	SP6	-	APTGT100H120G	N/A
		150	1.7	SP6	-	APTGT150H120G	APTGT150DH120G
		200	1.7	SP6	-	APTGT200H120G	APTGT200DH120G
	TRENCH 4	40	1.85	SP1	YES	APTGL40H120T1G	N/A
		60	1.85	SP3	YES	APTGL60H120T3G	APTGL60DH120T3G
		90	1.85	SP3	YES	APTGL90H120T3G	APTGL90DH120T3G
	TRENCH 4 FAST	40	2.05	SP1	YES	APTGLQ40H120T1G	N/A
		75	2.05	SP3	YES	APTGLQ75H120T3G	N/A
200		2.05	SP6	option	APTGLQ200H120G	N/A	
1700	TRENCH 3	30	2.0	SP3	YES	APTGT30H170T3G	N/A
		50	2.0	SP4	YES	APTGT50H170TG	APTGT50DH170TG
		100	2.0	SP6	-	APTGT100H170G	APTGT100DH170G
		150	2.0	SP6	-	APTGT150H170G	APTGT150DH170G



SP1



SP2



SP3



SP4



SP6 Full Bridge

NEW!  
NEW!

NEW!  
NEW!  
NEW!

# IGBT Power Modules

## SINGLE SWITCH

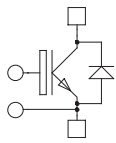

$V_{CES}$ (V)	IGBT Type	$I_c$ (A) $T_c=80^\circ\text{C}$	$V_{CE(on)}$ (V) at rated $I_c$	Package	NTC	Part Number
600	NPT FAST	360	2.1	D4	-	APTGF360U60D4G
		500	2.1	D4	-	APTGF500U60D4G
		660	2.1	D4	-	APTGF660U60D4G
1200	TRENCH 3	750	1.5	D4	-	APTGT750U60D4G
	NPT FAST	530	3.2	D4	-	APTGF530U120D4G
		400	1.7	D4	-	APTGT400U120D4G
		600	1.7	D4	-	APTGT600U120D4G
	TRENCH 4	475	1.85	D4	-	APTGL475U120D4G
		700	1.85	D4	-	APTGL700U120D4G
1700	TRENCH 3	400	2.0	D4	-	APTGT400U170D4G
		600	2.0	D4	-	APTGT600U170D4G



D4

## SINGLE SWITCH + SERIES DIODE

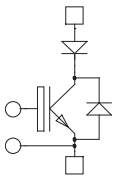

$V_{CES}$ (V)	IGBT Type	$I_c$ (A) $T_c=80^\circ\text{C}$	$V_{CE(on)}$ (V) at rated $I_c$	Package	NTC	Part Number
1200	NPT FAST	200	3.2	SP6	-	APTGF200U120DG
		300	3.2	SP6	-	APTGF300U120DG
	TRENCH 4	475	1.85	SP6	-	APTGL475U120DAG



SP4

## DUAL COMMON SOURCE

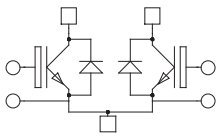

$V_{CES}$ (V)	IGBT Type	$I_c$ (A) $T_c=80^\circ\text{C}$	$V_{CE(on)}$ (V) at rated $I_c$	Package	NTC	Part Number
600	NPT FAST	90	2.1	SP4	YES	APTGF90DU60TG
		180	2.1	SP4	YES	APTGF180DU60TG
		350	2.1	SP6	-	APTGF350DU60G
	TRENCH 3	100	1.5	SP4	YES	APTGT100DU60TG
		200	1.5	SP4	YES	APTGT200DU60TG
		300	1.4	SP6	-	APTGT300DU60G
1200	NPT FAST	600	1.4	SP6	-	APTGT600DU60G
		100	3.2	SP4	YES	APTGF100DU120TG
		150	3.2	SP4	YES	APTGF150DU120TG
	TRENCH 3	300	3.2	SP6	-	APTGF300DU120G
		50	1.7	SP4	YES	APTGT50DU120TG
		75	1.7	SP4	YES	APTGT75DU120TG
		100	1.7	SP4	YES	APTGT100DU120TG
		150	1.7	SP6	-	APTGT150DU120G
		150	1.7	SP4	YES	APTGT150DU120TG
		200	1.7	SP6	-	APTGT200DU120G
		300	1.7	SP6	-	APTGT300DU120G
		400	1.7	SP6	-	APTGT400DU120G
1700	TRENCH 3	100	2.0	SP4	YES	APTGT100DU170TG
		225	2.0	SP6	-	APTGT225DU170G
		300	2.0	SP6	-	APTGT300DU170G



SP6

# Intelligent Power Modules

## PHASE LEG

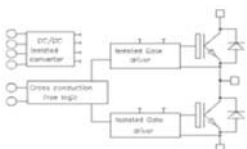

$V_{CES}$ (V)	IGBT Type	$I_c$ (A) $T_c=80^\circ\text{C}$	$V_{CE(on)}$ (V) at rated $I_c$	Package	NTC	Part Number
600	NPT FAST	350	2.1	LP8	-	APTLGF350A608G
	TRENCH 3	400	1.5	LP8	-	APTLGT400A608G
1200	NPT FAST	300	3.2	LP8	-	APTLGF300A1208G
	TRENCH 3	300	1.7	LP8	-	APTLGT300A1208G
	TRENCH 4	325	1.8	LP8	-	APTLGL325A1208G



LP8



# MOSFET Power Modules

## CHOPPER

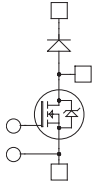
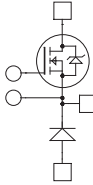
$V_{DSS}$ (V)	MOSFET Type	$R_{DS(ON)}$ (m $\Omega$ )	$I_D$ (A) $T_c=80^\circ\text{C}$	Package	NTC	 DA...or...U2	 SK...or...U3
100	MOS 5	11	100	SOT-227	-	APT10M11JVU2	APT10M11JVU3
		4.5	207	SP4	YES	APT10DAM05TG	APT10SKM05TG
		2.25	370	SP6	-	APT10DAM02G	APT10SKM02G
200	MOS 5	22	71	SOT-227	-	APT20M22JVU2	APT20M22JVU3
		8	147	SP4	YES	APT20DAM08TG	APT20SKM08TG
	MOS 7	5	250	SP6	option	APT20DAM05G	APT20SKM05G
		4	300	SP6	option	APT20DAM04G	APT20SKM04G
500	MOS 5	100	30	SOT-227	-	APT5010JVU2	APT5010JVU3
		100	30	SOT-227	-	APT5010JLLU2	APT5010JLLU3
		75	32	SOT-227	-	APT50M75JLLU2	APT50M75JLLU3
	MOS 7	19	125	SP6	option	APT50DAM19G	APT50SKM19G
		17	140	SP6	option	APT50DAM17G	APT50SKM17G
	MOS 8	65	43	SOT-227	-	APT58M50JU2	APT58M50JU3
600	COOLMOS	70	40	SOT-227	-	APT40N60JCU2	APT40N60JCU3
		24	70	SP1	YES	APTC60DAM24T1G	APTC60SKM24T1G
900	COOLMOS	120	25	SOT-227	-	APT33N90JCU2	APT33N90JCU3
		60	44	SP1	YES	APTC90DAM60T1G	APTC90SKM60T1G
1000	MOS 7	180	33	SP4	YES	APT100DA18TG	APT100SK18TG
		90	59	SP6	option	APT100DAM90G	APT100SKM90G
	MOS 8	330	17	SP1	YES	APT100DA33T1G	APT100SK33T1G
1200	MOS 8	560	13	SP1	YES	APT120DA56T1G	APT120SK56T1G
		300	23	SP1	YES	APT120DA30T1G	N/A

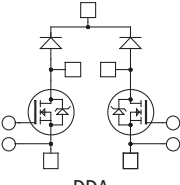
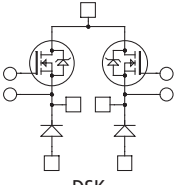

## DUAL CHOPPER

$V_{DSS}$ (V)	MOSFET Type	$R_{DS(ON)}$ (m $\Omega$ )	$I_D$ (A) $T_c=80^\circ\text{C}$	Package	NTC	 ...DDA...	 ...DSK...
100	MOS 5	19	50	SP3	YES	APT10DDAM19T3G	APT10DSKM19T3G
		9	100	SP3	YES	APT10DDAM09T3G	APT10DSKM09T3G
500	MOS 7	100	24	SP3	YES	APT50DDA10T3G	APT50DSK10T3G
		65	37	SP3	YES	APT50DDAM65T3G	APT50DSKM65T3G
		45	38	SP1	YES	APTC60DDAM45T1G	APTC60DSKM45T1G
600	COOLMOS	70	29	SP1	YES	APTC60DDAM70T1G	APTC60DSKM70T1G
		35	54	SP3	YES	APTC60DDAM35T3G	APTC60DSKM35T3G
		24	70	SP3	YES	APTC60DDAM24T3G	APTC60DSKM24T3G
		150	21	SP3	YES	APTC80DDA15T3G	APTC80DSK15T3G
900	COOLMOS	120	23	SP1	YES	APTC90DDA12T1G	APTC90DSK12T1G
1000	MOS 7	350	17	SP3	YES	APT100DDA35T3G	APT100DSK35T3G
1200	MOS 7	570	13	SP3	YES	APT120DDA57T3G	APT120DSK57T3G

# MOSFET Power Modules

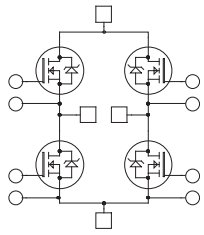

## FULL BRIDGE

V <sub>DSS</sub> (V)	MOSFET Type	R <sub>DS(ON)</sub> (mΩ)	I <sub>D</sub> (A) T <sub>C</sub> =80° C	Package	NTC	Part Number
100	FREDFET 5	4.5	207	SP6	-	APTM10HM05FG
		19	50	SP3	YES	APTM10HM19FT3G
		9	100	SP3	YES	APTM10HM09FT3G
200	FREDFET 7	20	62	SP4	YES	APTM20HM20FTG
		16	74	SP4	YES	APTM20HM16FTG
		10	125	SP6	-	APTM20HM10FG
		8	147	SP6	-	APTM20HM08FG
		140	18	SP3	YES	APTM50H14FT3G
500	FREDFET 7	100	24	SP3	YES	APTM50H10FT3G
		75	32	SP4	YES	APTM50HM75FTG
		75	32	SP3	YES	APTM50HM75FT3G
		65	37	SP4	YES	APTM50HM65FTG
		65	37	SP3	YES	APTM50HM65FT3G
		38	64	SP6	-	APTM50HM38FG
	35	70	SP6	-	APTM50HM35FG	
	FREDFET 8	150	19	SP1	YES	APTM50H15FT1G
		70	29	SP1	YES	APTC60HM70T1G
600	COOLMOS	45	38	SP1	YES	APTC60HM45T1G
		83	21	SP2	YES	APTC60HM83FT2G
		70	29	SP3	YES	APTC60HM70T3G
		35	54	SP3	YES	APTC60HM35T3G
		24	70	SP3	YES	APTC60HM24T3G
		230	15	SP1	YES	APTM60H23FT1G
800	COOLMOS	150	21	SP1	YES	APTC80H15T1G
		290	11	SP3	YES	APTC80H29T3G
		150	21	SP3	YES	APTC80H15T3G
900	COOLMOS	120	23	SP1	YES	APTC90H12T1G
		120	23	SP2	YES	APTC90H12T2G
		60	44	SP3	YES	APTC90HM60T3G
1000	FREDFET 7	450	14	SP3	YES	APTM100H45T3G
		350	17	SP4	YES	APTM100H35T5G
		350	17	SP3	YES	APTM100H35T3G
	FREDFET 8	180	33	SP6	-	APTM100H18FG
1200	FREDFET 8	460	14	SP3	YES	APTM100H46T3G
		290	25	SP6	-	APTM120H29FG
		1400	6	SP1	YES	APTM120H140FT1G



SP1

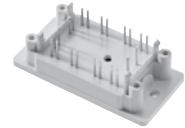

SP2



SP3



SP4



SP6

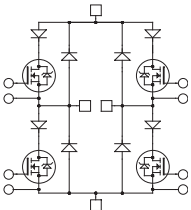

## FULL BRIDGE + SERIES AND PARALLEL DIODES

V <sub>DSS</sub> (V)	MOSFET Type	R <sub>DS(ON)</sub> (mΩ)	I <sub>D</sub> (A) T <sub>C</sub> =80° C	Package	NTC	Part Number
200	MOS 7	20	62	SP4	YES	APTM20HM20STG
500	MOS 7	75	32	SP4	YES	APTM50HM75STG
1000	MOS 7	450	13	SP4	YES	APTM100H45STG

## ASYMMETRICAL BRIDGE

V <sub>DSS</sub> (V)	MOSFET Type	R <sub>DS(ON)</sub> (mΩ)	I <sub>D</sub> (A) T <sub>C</sub> =80° C	Package	NTC	Part Number
100	MOS 5	9	100	SP3	YES	APTM10DHM09T3G
		4.5	207	SP6	-	APTM10DHM05G
200	MOS 7	16	77	SP3	YES	APTM20DHM16T3G
		8	147	SP6	-	APTM20DHM08G
		38	64	SP6	-	APTM50DHM38G
500	MOS 7	35	70	SP6	-	APTM50DHM35G
		MOS 8	65	32	SP3	YES
600	COOLMOS	24	70	SP3	YES	APTC60DHM24T3G

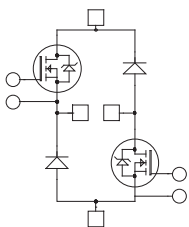

# MOSFET Power Modules

## PHASE LEG

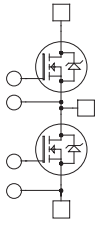

$V_{DSS}$ (V)	MOSFET Type	$R_{DS(ON)}$ (m $\Omega$ )	$I_D$ (A) $T_C=80^\circ\text{C}$	Package	NTC	Part Number
100	FREDFET 5	4.5	207	SP4	YES	APTM10AM05FTG
		2.25	370	SP6	option	APTM10AM02FG
200	FREDFET 7	10	125	SP4	YES	APTM20AM10FTG
		8	147	SP4	YES	APTM20AM08FTG
		5	250	SP6	option	APTM20AM05FG
		4	300	SP6	option	APTM20AM04FG
500	FREDFET 7	38	64	SP4	YES	APTM50AM38FTG
		35	70	SP4	YES	APTM50AM35FTG
		19	125	SP6	option	APTM50AM19FG
		17	140	SP6	option	APTM50AM17FG
600	COOLMOS	45	38	SP1	YES	APTC60AM45T1G
		42	40	SP2	-	APTC60AM42F2G
		35	54	SP1	YES	APTC60AM35T1G
		24	70	SP1	YES	APTC60AM24T1G
	24	70	SP2	-	APTC60AM242G	
900	COOLMOS	110	30	SP1	YES	APTM60A11FT1G
		60	44	SP1	YES	APTC90AM60T1G
1000	FREDFET 7	60	44	SP2	-	APTC90AM602G
		180	33	SP4	YES	APTM100A18FTG
1200	FREDFET 7	90	59	SP6	option	APTM100AM90FG
		400	16	SP1	YES	APTM100A40FT1G
1200	FREDFET 8	290	25	SP4	YES	APTM120A29FTG
		150	45	SP6	option	APTM120A15FG
		650	12	SP1	YES	APTM120A65FT1G



SP1

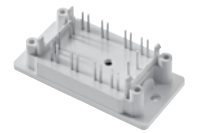

SP2



SP4



SP6



SP6-P

## PHASE LEG + SERIES AND PARALLEL DIODES

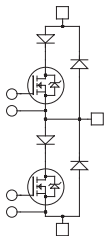

$V_{DSS}$ (V)	MOSFET Type	$R_{DS(ON)}$ (m $\Omega$ )	$I_D$ (A) $T_C=80^\circ\text{C}$	Package	NTC	Part Number
200	MOS 7	10	125	SP4	YES	APTM20AM10STG
		6	225	SP6	-	APTM20AM06PSG
500	MOS 7	38	64	SP4	YES	APTM50AM38STG
		24	110	SP6	-	APTM50AM24SG
1000	MOS 7	230	26	SP4	YES	APTM100A23STG
		130	49	SP6	-	APTM100A13SG
1200	MOS 7	200	37	SP6	-	APTM120A20SG

## PHASE LEG + SERIES DIODES

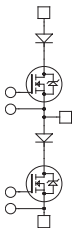

$V_{DSS}$ (V)	MOSFET Type	$R_{DS(ON)}$ (m $\Omega$ )	$I_D$ (A) $T_C=80^\circ\text{C}$	Package	NTC	Part Number
1000	MOS 7	130	49	SP6	-	APTM100A13DG
1200	MOS 7	200	37	SP6	-	APTM120A20DG

## TRIPLE PHASE LEG

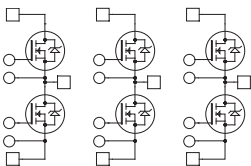

$V_{DSS}$ (V)	MOSFET Type	$R_{DS(ON)}$ (m $\Omega$ )	$I_D$ (A) $T_C=80^\circ\text{C}$	Package	NTC	Part Number
75	MOSFET	4.2	90	SP6-P	option	APTM08TAM04PG
100	FREDFET 5	19	50	SP6-P	option	APTM10TAM19FPG
		9	100	SP6-P	option	APTM10TAM09FPG
200	FREDFET 7	16	74	SP6-P	option	APTM20TAM16FPG
500	FREDFET 7	65	37	SP6-P	option	APTM50TAM65FPG
600	COOLMOS	35	54	SP6-P	option	APTC60TAM35PG
		24	70	SP6-P	YES	APTC60TAM24TPG
800	COOLMOS	150	21	SP6-P	option	APTC80TA15PG
900	COOLMOS	60	44	SP6-P	YES	APTC90TAM60TPG
1000	FREDFET 7	350	17	SP6-P	option	APTM100TA35FPG

# MOSFET Power Modules

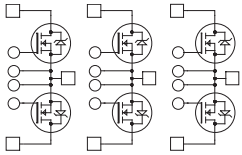

## TRIPLE DUAL COMMON SOURCE

$V_{DS}$ (V)	MOSFET Type	$R_{DS(ON)}$ (m $\Omega$ )	$I_D$ (A) $T_C=80^\circ\text{C}$	Package	NTC	Part Number
100	MOS 5	9	100	SP6-P	option	APTM10TDUM09PG
600	COOLMOS	35	54	SP6-P	option	APTC60TDUM35PG
800	COOLMOS	150	21	SP6-P	option	APTC80TDU15PG
1200	MOS 7	570	13	SP6-P	option	APTM120TDU57PG



SP1



SP3



SP4

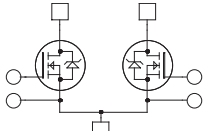

## DUAL COMMON SOURCE

$V_{DS}$ (V)	MOSFET Type	$R_{DS(ON)}$ (m $\Omega$ )	$I_D$ (A) $T_C=80^\circ\text{C}$	Package	NTC	Part Number
100	MOS 5	2.25	370	SP6	-	APTM10DUM02G
		8	147	SP4	YES	APTM20DUM08TG
200	MOS 7	5	250	SP6	-	APTM20DUM05G
		4	300	SP6	-	APTM20DUM04G
		35	70	SP4	YES	APTM50DUM35TG
500	MOS 7	17	140	SP6	-	APTM50DUM17G
		90	59	SP6	-	APTM100DUM90G
1200	MOS 7	150	45	SP6	-	APTM120DU15G

## SINGLE SWITCH

$V_{DS}$ (V)	MOSFET Type	$R_{DS(ON)}$ (m $\Omega$ )	$I_D$ (A) $T_C=80^\circ\text{C}$	Package	NTC	Part Number
100	FREDFET 5	2.25	430	SP6	option	APTM10UM02FAG
		1.5	640	SP6	option	APTM10UM01FAG
200	FREDFET 7	3	434	SP6	option	APTM20UM03FAG
500	FREDFET 7	9	371	SP6	option	APTM50UM09FAG
1000	FREDFET 7	60	97	SP6	option	APTM100UM60FAG
		45	160	SP6	option	APTM100UM45FAG
1200	FREDFET 7	70	126	SP6	option	APTM120UM70FAG

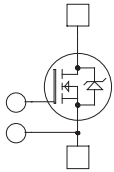

SP6

## SINGLE SWITCH + SERIES DIODE

$V_{DS}$ (V)	MOSFET Type	$R_{DS(ON)}$ (m $\Omega$ )	$I_D$ (A) $T_C=80^\circ\text{C}$	Package	NTC	Part Number
1000	MOS 7	65	110	SP6	-	APTM100UM65DAG
		45	160	SP6	-	APTM100UM45DAG
1200	MOS 7	70	126	SP6	-	APTM120UM70DAG

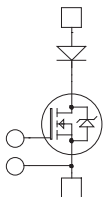

SP6-P

## SINGLE SWITCH + SERIES AND PARALLEL DIODES

$V_{DS}$ (V)	MOSFET Type	$R_{DS(ON)}$ (m $\Omega$ )	$I_D$ (A) $T_C=80^\circ\text{C}$	Package	NTC	Part Number
200	MOS 7	4	310	SP6	option	APTM20UM04SAG
500	MOS 7	13	250	SP6	option	APTM50UM13SAG
1000	MOS 7	65	110	SP6	option	APTM100UM65SAG
1200	MOS 7	100	86	SP6	option	APTM120U10SAG

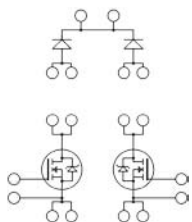
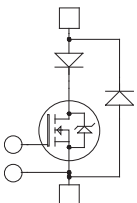

## INTERLEAVED PFC

$V_{DS}$ (V)	MOSFET Type	$R_{DS(ON)}$ (m $\Omega$ )	$I_D$ (A) $T_C=80^\circ\text{C}$	Package	NTC	Part Number
600	COOLMOS	45	38	SP1	YES	APTC60VDAM45T1G
		24	70	SP3	YES	APTC60VDAM24T3G
1000	MOS 7	350	17	SP3	YES	APTM100VDA35T3G
1200		570	13	SP3	YES	APTM120VDA57T3G

## SINGLE AND DUAL LINEAR MOSFET

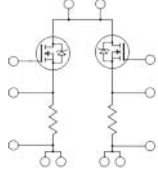
$V_{DS}$ (V)	MOSFET Type	$R_{DS(on)}$ (m $\Omega$ )	Shunt Resistor (mR)	Package	NTC		
100	MOS 5	9	4.4	SP1 or SP3	YES	APTML10UM09R004T1AG	APTML102UM09R004T3AG
200		18	10		YES	APTML20UM18R010T1AG	APTML202UM18R010T3AG
500	MOSFET Linear	90	20		YES	APTML50UM90R020T1AG	APTML502UM90R020T3AG
600		125	20		YES	APTML60U12R020T1AG	APTML602U12R020T3AG
1000	MOS 4 Linear	600	20		YES	APTML100U60R020T1AG	APTML1002U60R020T3AG

## Renewable Energy Power Modules

### FULL BRIDGE

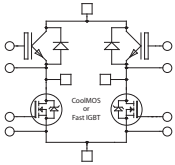

$V_{CES}$ (V)	Technology	$I_c$ (A) $T_c=80^\circ\text{C}$	$V_{CE(on)}$ (V) at rated $I_c$	Package	NTC	Part Number
600	Mix Trench IGBT & NPT IGBT	50	2.1/1.5	SP3	YES	APTVG50H60T3G
		75	2.1/1.5	SP3	YES	APTVG75H60T3G
		100	2.1/1.5	SP3	YES	APTVG100H60T3G
	Mix Trench IGBT & CoolMOS	50	83mR/1.5	SP1	YES	APTCV40H60CT1G
50		45mR/1.5	SP3	YES	APTCV50H60T3G	
1200	Mix Trench IGBT & NPT IGBT	25	3.2/1.7	SP3	YES	APTVG25H120T3G
		50	3.2/1.7	SP3	YES	APTVG50H120T3G



SP1



SP3

### PFC + BYPASS DIODE + PHASE LEG

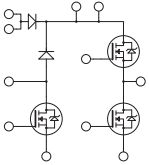

$V_{CES}$ (V)	Technology	$I_c$ (A) $T_c=80^\circ\text{C}$	$V_{CE(on)}$ (V) at rated $I_c$	Package	NTC	Special	Part Number
600	COOLMOS	38	45mR	SP1	N/A	10A PFC SiC diode	APTC60AM45B1G
		38	45mR	SP1	N/A	-	APTC60AM45B1G
		27	83mR	SP1	N/A	10A PFC SiC diode	APTC60AM83B1G
		27	83mR	SP1	N/A	-	APTC60AM83B1G

### PFC + FULL BRIDGE

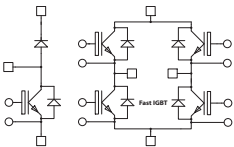

$V_{CES}$ (V)	Technology	$I_c$ (A) $T_c=80^\circ\text{C}$	$V_{CE(on)}$ (V) at rated $I_c$	Package	NTC	Part Number
600	Mix Trench IGBT & NPT IGBT	50	2.1/1.5	SP4	-	APTVG50H60BG
		100	2.1/1.5	SP6-P	YES	APTVG100H60BTPG
1200	Mix Trench IGBT & NPT IGBT	25	3.2/1.7	SP4	-	APTVG25H120BG
		50	3.2/1.7	SP6-P	YES	APTVG50H120BTPG

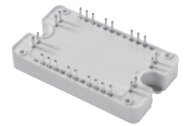

SP3F



SP4

### PFC + BYPASS DIODE + FULL BRIDGE

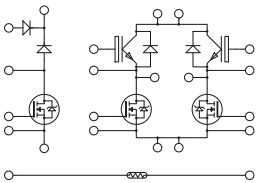

$V_{CES}$ (V)	Technology	$I_c$ (A) $T_c=80^\circ\text{C}$	$V_{CE(on)}$ (V) at rated $I_c$	Package	NTC	Special	Part Number	
600	Mix Trench IGBT & CoolMos	38	1.5/45mR	SP3F	YES	20A PFC SiC diode	APTCV60HM45BC20T3G	
		38	1.5/45mR	SP3F	YES	-	APTCV60HM45BT3G	
		29	1.5/70mR	SP3F	YES	-	APTCV60HM70BT3G	
	COOLMOS	29	70mR	SP3F	YES	-	APTCV60HM70BT3G	
		Mix Trench IGBT & NPT IGBT	50	3.2/1.7	SP3F	YES	-	APTVG50H60BT3G

### SECONDARY FAST RECTIFIER + FULL BRIDGE

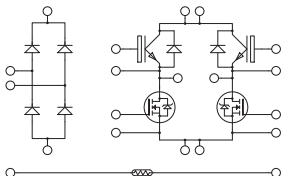

$V_{CES}$ (V)	Technology	$I_c$ (A) $T_c=80^\circ\text{C}$	$V_{CE(on)}$ (V) at rated $I_c$	Package	NTC	Special	Part Number	
600	Mix Trench IGBT & CoolMos	38	1.5/45mR	SP3F	YES	20A SiC antiparallel diode	APTCV60HM45RCT3G	
		38	1.5/45mR	SP3F	YES	-	APTCV60HM45RT3G	
		29	1.5/70mR	SP3F	YES	-	APTCV60HM70RT3G	
	COOLMOS	29	70mR	SP3F	YES	-	APTCV60HM70RT3G	
		TRENCH 3	50	1.5	SP3F	YES	-	APTVG50H60RT3G



SP6-P

# Renewable Energy Power Modules

## BOOST BUCK

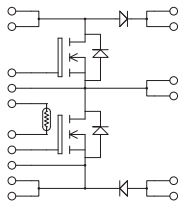

$V_{CES}$ (V)	Technology	$I_C$ (A) $T_c=80^\circ\text{C}$	$V_{CE(on)}$ (V) at rated $I_C$	Package	NTC	Part Number
600	COOLMOS	70	24mR	SP3F	YES	APTC60BBM24T3G
600	TRENCH 3	100	1.5	SP3F	YES	APTGT100BB60T3G



SP1

## 3-LEVEL NPC INVERTER

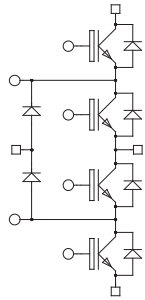

$V_{CES}$ (V)	Technology	$I_C$ (A) $T_c=80^\circ\text{C}$	$V_{CE(on)}$ (V) at rated $I_C$	Package	NTC	Part Number
600	TRENCH 3	20	1.5	SP1	-	APTGT20TL601G
		30	1.5	SP3	YES	APTGT30TL60T3G
		30	1.5	SP1	-	APTGT30TL601G
		50	1.5	SP3	YES	APTGT50TL60T3G
		50	1.5	SP1	-	APTGT50TL601G
		75	1.5	SP3	YES	APTGT75TL60T3G
		100	1.5	SP3	YES	APTGT100TL60T3G
		150	1.5	SP6	-	APTGT150TL60G
		200	1.5	SP6	-	APTGT200TL60G
		300	1.5	SP6	-	APTGT300TL60G
600	NPT FAST	30	2.1	SP1	-	APTF30TL601G
		50	2.1	SP3	YES	APTF50TL60T3G
1200	TRENCH 4	60	1.85	SP3	YES	APTGL60TL120T3G
1700	TRENCH 3	240	1.8	SP6	-	APTGL240TL120G
		100	2.0	SP6	-	APTGT100TL170G



SP3



SP3F

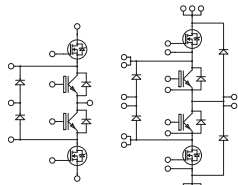

SP1

SP3

$V_{CES}$ (V)	Technology	$R_{DS(ON)}$ Coolmos (m $\Omega$ )	$V_{CE(on)}$ IGBT (V) / $I_C$ (A)	Package	NTC	Part Number
600	Mix Trench IGBT & CoolMOS	24	1.5/75	SP3	YES	APTCV60TLM24T3G
		45	1.5/75	SP3	YES	APTCV60TLM45T3G
		70	1.5/50	SP3	YES	APTCV60TLM70T3G
		99	1.5/30	SP3	YES	APTCV60TLM99T3G
900	Mix Trench IGBT & CoolMOS	120	1.85/50	SP3	YES	APTCV90TL12T3G



SP6 3-Level

## T-TYPE 3-LEVEL INVERTER

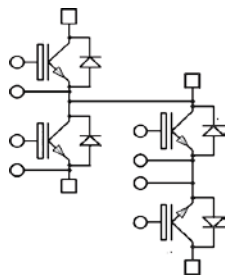

$V_{CES}$ (V)	Technology	$I_C$ (A) $T_c=80^\circ\text{C}$	$V_{CE(on)}$ (V) at rated $I_C$	Package	NTC	Special	Part Number
600/1200	TRENCH 4 FAST	40	2.05	SP3F	YES	10A/600V SiC	APTGL40HR120CT3G <b>NEW!</b>
		80	2.05	SP3F	YES	30A/600V SiC	APTGL80HR120CT3G <b>NEW!</b>
		200	2.05	SP6	NO	-	APTGL200HR120G <b>NEW!</b>



# Power Modules with SiC Schottky Diodes

Silicon Carbide (SiC) Schottky Diodes offer superior dynamic and thermal performance over conventional Silicon power diodes. The main advantages of the SiC Schottky Diodes are:

- Essentially zero forward and reverse recovery = reduced switch and diode switching losses
- Temperature independent switching behavior = stable high temperature performance
- Positive temperature coefficient of VF = ease of parallel operation
- Usable 175°C Junction Temperature = safely operate at higher temperatures

Extremely fast switching of SiC Schottky diode enables designs with:

- Improved System Efficiency
- Higher Reliability
- Lower System Switching Losses
- Lower System Cost
  - Smaller EMI Filter
  - Smaller Magnetic Components
  - Smaller Heat-Sink
  - Smaller Switches, Eliminate Snubbers
- Reduced System Size .
- Fewer / Smaller Components

## Applications:

- PFC
- Output Rectification
- Solar Inverter
- Motor Control
- Snubber Diode

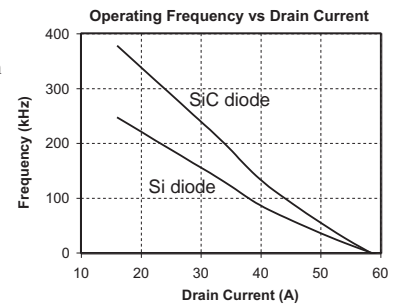

## Diode Power Modules with SiC Diodes

### DUAL DIODE

$V_{RRM}$ (V)	DIODE Type	IF (A) $T_c=100^\circ\text{C}$	VF (V) $T_j=25^\circ\text{C}$	Package	Anti-Parallel	Parallel
600	SiC	20	1.6	SOT-227	APT2X20DC60J	APT2X21DC60J
		30	1.6	SOT-227	APT2X30DC60J	APT2X31DC60J
		40	1.6	SOT-227	APT2X40DC60J	APT2X41DC60J
		50	1.6	SOT-227	APT2X50DC60J	APT2X51DC60J
		60	1.6	SOT-227	APT2X60DC60J	APT2X61DC60J
		90	1.6	SP1	-	APTDC902U601G
1200	SiC	20	1.6	SOT-227	APT2X20DC120J	APT2X21DC120J
		30	1.6	SOT-227	APT2X30DC120J	APT2X31DC120J
		40	1.6	SOT-227	APT2X40DC120J	APT2X41DC120J
		50	1.6	SOT-227	APT2X50DC120J	APT2X51DC120J
		60	1.6	SOT-227	APT2X60DC120J	APT2X61DC120J



SOT-227



SP1

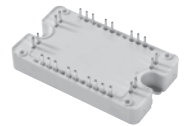

SP3F

### FULL BRIDGE

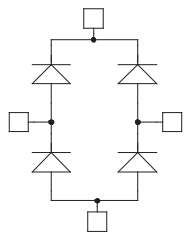

$V_{RRM}$ (V)	DIODE Type	IF (A) $T_c=100^\circ\text{C}$	VF (V) $T_j=25^\circ\text{C}$	Package	Part Number
600	SiC	6	1.6	SOT-227	APT06DC60HJ
		10	1.6	SP1	APTDC10H601G
		20	1.6	SP1	APTDC20H601G
		40	1.6	SP1	APTDC40H601G
		40	1.6	SOT-227	APT40DC60HJ
1200	SiC	10	1.6	SOT-227	APT10DC120HJ
		20	1.6	SP1	APTDC20H1201G
		20	1.6	SOT-227	APT20DC120HJ
		40	1.6	SP1	APTDC40H1201G
		40	1.6	SOT-227	APT40DC120HJ

## IGBT Power Modules with SiC Diodes

### BOOST CHOPPER

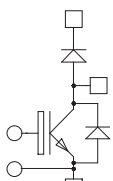

$V_{RRM}$ (V)	IGBT Type	IC (A) $T_c=80^\circ\text{C}$	$V_{CE(on)}$ (V) at rated $I_c$	Package	NTC	Part Number
600	NPT	50	2.1	SOT-227	-	APT50GF60JCU2
		90	2.1	SP1	YES	APTGF90DA60CT1G
1200	NPT	15	3.2	SOT-227	-	APT15GF120JCU2
		25	3.2	SOT-227	-	APT25GF120JCU2
		50	3.2	SP1	YES	APTGF50DA120CT1G
		25	2.05	SOT-227	-	APT25GLQ120JCU2
	TRENCH 4 FAST	40	2.05	SOT-227	-	APT40GLQ120JCU2

NEW!  
NEW!

### DUAL CHOPPER

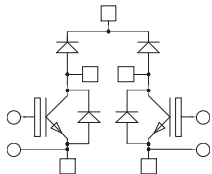

$V_{RRM}$ (V)	IGBT Type	IC (A) $T_c=80^\circ\text{C}$	$V_{CE(on)}$ (V) at rated $I_c$	Package	NTC	Part Number
1200	TRENCH 4 FAST	40	2.05	SP3F	YES	APTGLQ40DDA120CT3G

NEW!

# Power Modules with SiC Schottky Diodes

## MOSFETs & COOLMOS™ Power Modules with SiC Diodes

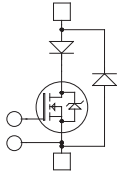

### SINGLE SWITCH + SERIES FRED AND SIC PARALLEL DIODES

V <sub>DSS</sub> (V)	MOSFET Type	R <sub>DS(ON)</sub> (mΩ)	I <sub>D</sub> (A) T <sub>c</sub> =80° C	Package	NTC	Part Number
1000	MOS7	65	110	SP6	option	APTM100UM65SCAVG
1200	MOS7	100	86	SP6	option	APTM120U10SCAVG



SOT-227

### CHOPPER

V <sub>DSS</sub> (V)	MOSFET Type	R <sub>DS(ON)</sub> (mΩ)	I <sub>D</sub> (A) T <sub>c</sub> =80° C	Package	NTC	...DA... or U2	...SK... or U3
500	MOS8	65	43	SOT-227	-	APT58M50JCU2	APT58M50JCU3
600	COOLMOS	45	38	SOT-227	-	APT50N60JCCU2	N/A
		24	70	SP1	YES	APTC60DAM24CT1G	APTC60SKM24CT1G
900	COOLMOS	18	107	SP4	YES	APTC60DAM18CTG	N/A
		120	25	SOT-227	-	APT33N90JCCU2	APT33N90JCCU3
1000	MOS 8	60	44	SP1	YES	APTC90DAM60CT1G	APTC90SKM60CT1G
		330	20	SOT-227	-	APT26M100JCU2	APT26M100JCU3
1200	MOS 8	180	30	SP1	YES	APTM100DA18CT1G	N/A
		560	15	SOT-227	-	APT20M120JCU2	APT20M120JCU3
		300	23	SP1	YES	APTM120DA30CT1G	N/A



SP1

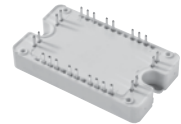

SP3F

### DUAL CHOPPER

V <sub>DSS</sub> (V)	MOSFET Type	R <sub>DS(ON)</sub> (mΩ)	I <sub>D</sub> (A) T <sub>c</sub> =80° C	Package	NTC	...DDA...	...DSK...
600	COOLMOS	45	38	SP1	YES	APTC60DDAM45CT1G	APTC60DSKM45CT1G
		70	29	SP1	YES	APTC60DDAM70CT1G	APTC60DSKM70CT1G



SP4

### PHASE LEG + SERIES FRED AND SIC PARALLEL DIODES

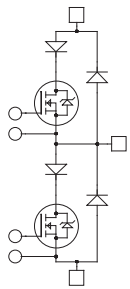

V <sub>DSS</sub> (V)	MOSFET Type	R <sub>DS(ON)</sub> (mΩ)	I <sub>D</sub> (A) T <sub>c</sub> =80° C	Package	NTC	Part Number
500	MOS 7	38	67	SP4	YES	APTM50AM38SCTG
		24	110	SP6	-	APTM50AM24SCG
600	COOLMOS	35	54	SP4	YES	APTC60AM35SCTG
		24	70	SP4	YES	APTC60AM24SCTG
		18	107	SP6	-	APTC60AM18SCG
900	COOLMOS	60	44	SP4	YES	APTC90AM60SCTG
800	COOLMOS	150	21	SP4	YES	APTC80A15SCTG
		100	32	SP4	YES	APTC80A10SCTG
		75	43	SP6	-	APTC80AM75SCG
1000	MOS 7	130	49	SP6	-	APTM100A13SCG



SP6

### FULL BRIDGE + SERIES FRED AND SIC PARALLEL DIODES

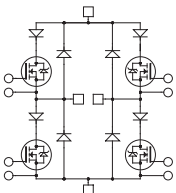

V <sub>DSS</sub> (V)	MOSFET Type	R <sub>DS(ON)</sub> (mΩ)	I <sub>D</sub> (A) T <sub>c</sub> =80° C	Package	NTC	Part Number
500	MOS 7	75	34	SP4	YES	APTM50HM75SCTG
600	COOLMOS	70	29	SP4	YES	APTC60HM70SCTG
		45	38	SP4	YES	APTC60HM45SCTG
800	COOLMOS	290	11	SP4	YES	APTC80H29SCTG
900	COOLMOS	120	23	SP4	YES	APTC90H12SCTG
1000	MOS 7	450	14	SP4	YES	APTM100H45SCTG



SP6-P

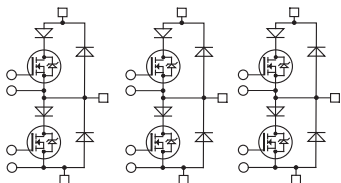

### TRIPLE PHASE LEG

V <sub>DSS</sub> (V)	MOSFET Type	R <sub>DS(ON)</sub> (mΩ)	I <sub>D</sub> (A) T <sub>c</sub> =80° C	Package	NTC	Part Number
600	COOLMOS	24	87	SP6-P	YES	APTC60TAM21SCTPAG
1000	MOS 7	350	50	SP6-P	YES	APTM100TA35SCTPG

**NEW!**  
**NEW!**

# SiC MOSFET Power Modules

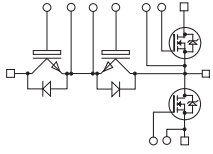

## T-TYPE 3-LEVEL INVERTER

$V_{CES}$ (V)	Technology	$R_{DS(ON)}$ (m $\Omega$ )	$I_D$ (A) $T_c=80^\circ\text{C}$	Package	NTC	Part Number
600/1200	IGBT & SiC MOSFET	110	20	SP3F	YES	APTMC120HR11CT3G <b>NEW!</b>
		40	50	SP3F	YES	APTMC120HRM40CT3G <b>NEW!</b>



SOT-227

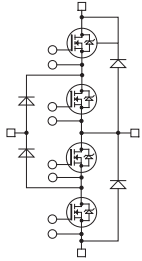

## 3-LEVEL NPC INVERTER

$V_{CES}$ (V)	Technology	$R_{DS(ON)}$ (m $\Omega$ )	$I_D$ (A) $T_c=80^\circ\text{C}$	Package	NTC	Part Number
600	SiC MOSFET	110	20	SP3F	YES	APTMC60TL11CT3AG <b>NEW!</b>
		55	40	SP3F	YES	APTMC60TLM55CT3AG <b>NEW!</b>
		20	110	SP3F	YES	APTMC60TLM20CT3AG <b>NEW!</b>
		14	160	SP6	-	APTMC60TLM14CAG <b>NEW!</b>



SP1



SP3F

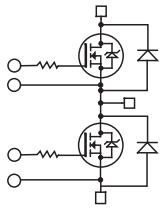

## PHASE LEG

$V_{CES}$ (V)	Technology	$R_{DS(ON)}$ (m $\Omega$ )	$I_D$ (A) $T_c=80^\circ\text{C}$	Package	NTC	Part Number
1200	SiC MOSFET	55	40	SP1	YES	APTMC120AM55CT1AG <b>NEW!</b>
		20	100	SP1	YES	APTMC120AM20CT1AG <b>NEW!</b>
		8	185	D3	-	APTMC120AM08CD3AG <b>NEW!</b>



SP6 3-Level

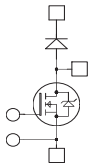

## BOOST CHOPPER

$V_{CES}$ (V)	Technology	$R_{DS(ON)}$ (m $\Omega$ )	$I_D$ (A) $T_c=80^\circ\text{C}$	Package	NTC	Part Number
1200	SiC MOSFET	40	50	SOT-227	-	APT50MC120JCU2 <b>NEW!</b>
		20	100		-	APT100MC120JCU2 <b>NEW!</b>



D3

# DIODE Power Modules

## SINGLE DIODE

$V_{RRM}$ (V)	DIODE Type	IF (A) $T_c=80^\circ\text{C}$	VF (V) $T_j=25^\circ\text{C}$	Package	
200	FRED	500	1.1	LP4	
400		500	1.5		
600		450	1.8		
1000		430	2.3		
1200		400	2.5		



Non Isolated Packages



## SINGLE DIODE - NON ISOLATED PACKAGE

$V_{RRM}$ (V)	DIODE Type	IF (A) per Diode	VF (V) $T_j=25^\circ\text{C}$	Package		
					Cathode to Base	Cathode to Base
600	FRED	100	1.35	Half-Pack	HU10260	HU10260R
		200			HU20260	HU20260R
400	RECTIFIER	300	1.1	SDM	SDM30004	SDM30004R
30	SCHOTTKY	180	0.55	Half-Pack	HS18230	HS18230R
		240			HS24230	HS24230R
35		180	0.70		HS18135	HS18135R
		180	0.71		HS18140	HS18140R
40		240	0.56		HS24040	HS24040R
		120	0.55		HS12045	HS12045R
45		180	0.72		HS18145	HS18145R
		240	0.57		HS24045	HS24045R
100		120	0.91		HS123100	HS123100R
		180			HS183100	HS183100R
150		240	0.86		HS243100	HS243100R
		240	0.87		HS246150	HS246150R
180		240	0.88		HS247180	HS247180R
		240	0.89		HS247200	HS247200R



## 3-PHASE BRIDGE

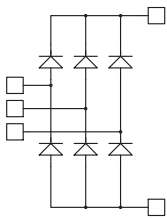

$V_{RRM}$ (V)	DIODE Type	IF (A) $T_c=80^\circ\text{C}$	VF (V) $T_j=25^\circ\text{C}$	Package	Part Number
1600	RECTIFIER	40	1.3	SP1	APTDR40X1601G
		90	1.3	SP1	APTDR90X1601G
800 1200 1600 1800	RECTIFIER	30	1.6	SM1	MSD30-08/12/16/18
		50	1.5	SM1	MSD50-08/12/16/18
		50	1.45	SM2-1	MSDM50-08/12/16/18
		52	1.8	SM2	MSD52-08/12/16/18
		75	1.6	SM2	MSD75-08/12/16/18
		75	1.38	SM2-1	MSDM75-08/12/16/18
		100	1.9	SM3	MSD100-08/12/16/18
		100	1.7	SM2-1	MSDM100-08/12/16/18
		130	1.8	SM3	MSD130-08/12/16/18
		150	1.28	SM3-1	MSDM150-08/12/16/18
		160	1.65	SM3	MSD160-08/12/16/18
		200	1.55	SM3	MSD200-08/12/16/18
		200	1.31	SM3-1	MSDM200-08/12/16/18

## 3-PHASE BRIDGE + THYRISTOR

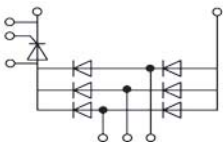

$V_{RRM}$ (V)	DIODE Type	IF (A) $T_c=80^\circ\text{C}$	VF (V) $T_j=25^\circ\text{C}$	Package	Part Number
1600	RECTIFIER THYRISTOR	75	1.4	SM4	MSDT75-16
		100	1.35	SM4	MSDT100-16
		150	1.35	SM4	MSDT150-16
		200	1.35	SM5	MSDT200-16

# DIODE Power Modules

## FULL BRIDGE

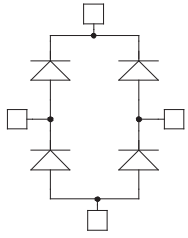

$V_{RRM}$ (V)	DIODE Type	IF (A) $T_c=80^\circ\text{C}$	VF (V) $T_j=25^\circ\text{C}$	Package Style	Part Number	
200	FRED	30	1.0	SOT-227	APT30DF20HJ	
		60	1.0	SOT-227	APT60DF20HJ	
		100	1.0	SP4	APTDF100H20G	
		200	1.0	SP6	APTDF200H20G	
600		30	1.6	SOT-227	APT30DL60HJ	
		30	1.8	SP1	APTDF30H601G	
		30	1.8	SOT-227	APT30DF60HJ	
		50	1.6	SOT-227	APT50DL60HJ	
		60	1.8	SOT-227	APT60DF60HJ	
		60	1.8	SP1	APTDF60H601G	
		75	1.6	SOT-227	APT75DL60HJ	
		100	1.6	SOT-227	APT100DL60HJ	
		100	1.6	SP1	APTDF100H601G	
		200	1.6	SP6	APTDF200H60G	
		1000	30	2.1	SOT-227	APT30DF100HJ
			60	2.1	SOT-227	APT60DF100HJ
100			2.1	SP4	APTDF100H100G	
200			2.1	SP6	APTDF200H100G	
30			2.6	SP1	APTDF30H1201G	
1200			30	2.6	SOT-227	APT30DF120HJ
		35	1.6	SOT-227	APT35DL120HJ	
		50	1.6	SOT-227	APT50DL120HJ	
		60	2.6	SP1	APTDF60H1201G	
		60	2.6	SOT-227	APT60DF120HJ	
		75	1.6	SOT-227	APT75DL120HJ	
		100	2.5	SP1	APTDF100H1201G	
		200	2.4	SP6	APTDF200H120G	
		1700	50	1.8	SOT-227	APT50DF170HJ
			75	1.8	SOT-227	APT75DF170HJ
100			2.2	SP4	APTDF100H170G	
200			2.2	SP6	APTDF200H170G	
45		SCHOTTKY	40	0.9	SOT-227	APT40DS04HJ
			60			APT60DS04HJ
100			40			APT40DS10HJ
			60			APT60DS10HJ
200			30			APT30DS20HJ
			60			APT60DS20HJ
200		RECTIFIER	10	1.3	VJ	VJ248M
						VJ448M
400			40		SOT-227	APT40DR160HJ
						90
1600		Controlled Avalanche Rectifiers	10	1.3	VJ	VJ247M
						VJ447M
660-1100						VJ647M



## THYRISTOR & DIODE DOUBLER

$V_{RRM}$ (V)	DIODE Type	IF (A) per Diode	VF/VTM (V) $T_j=25^\circ\text{C}$	Package Style	Thyristor Diode Doubler	Thyristor Doubler
800 1200 1600	RECTIFIER THYRISTOR	25	1.8	SF1	MSFC25-08/12/16	MSTC25-08/12/16
		40	1.95		MSFC40-08/12/16	MSTC40-08/12/16
		60	1.65		MSFC60-08/12/16	MSTC60-08/12/16
		90	1.65		MSFC90-08/12/16	MSTC90-08/12/16
		110	1.65		MSFC110-08/12/16	MSTC110-08/12/16
		130	1.8		MSFC130-08/12/16	MSTC130-08/12/16
		D1	160	1.7	MSFC160-08/12/16	MSTC160-08/12/16

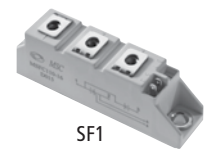
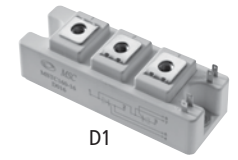

# DIODE Power Modules

## COMMON CATHODE - COMMON ANODE - DOUBLER

V <sub>RRM</sub> (V)	DIODE Type	IF (A) per Diode	VF (V) T <sub>j</sub> =25° C	Package	Circuit Diagrams				
					Common Cathode	Common Anode	Doubler		
200	FRED	400	1.0	SP6					
600			1.6						
1000			2.1						
1200			2.4						
1700			2.2						
800-1200-1600-1800			RECTIFIER					36	1.15
60	MSKD60-08/12/16/18	MSAD60-08/12/16/18		MSCD60-08/12/16/18					
70	MSKD70-08/12/16/18	MSAD70-08/12/16/18		MSCD70-08/12/16/18					
100	MSKD100-08/12/16/18	MSAD100-08/12/16/18		MSCD100-08/12/16/18					
120	MSKD120-08/12/16/18	MSAD120-08/12/16/18		MSCD120-08/12/16/18					
165	MSKD165-08/12/16/18	MSAD165-08/12/16/18		MSCD165-08/12/16/18					
200	SD2	MSKD200-08/12/16/18		MSAD200-08/12/16/18	MSCD200-08/12/16/18				
200	FRED	35		0.95	Mini-Mod	UFT7020	UFT7020A	UFT7020D	
200		60		0.98	TwinTower	UFT12520	UFT12520A	UFT12520D	
		70		0.98	TO-249 Flat Pack	UFT14020	UFT14020A	UFT14020D	
		100		0.98	TwinTower	UFT20020	UFT20020A	UFT20020D	
				1.25		UFT20120	UFT20120A	UFT20120D	
300		200	0.98	Mini-Mod	UFT40020	UFT40020A	UFT40020D		
		35	1.20		UFT7130	UFT7130A	UFT7130D		
		400	1.25		TO-249 Flat Pack	UFT14140	UFT14140A	UFT14140D	
		100	1.25		TwinTower	UFT20140	UFT20140A	UFT20140D	
500		35	1.20	Mini-Mod	UFT7150	UFT7150A	UFT7150D		
			1.35		UFT7260SMxC	UFT7260SMxA	UFT7260SMxD		
		70	1.35	TO-249 Flat Pack	UFT14260	UFT14260A	UFT14260D		
		800	60	1.35	TwinTower	UFT12780	UFT12780A	UFT12780D	
70		1.35	TO-249 Flat Pack	UFT14280	UFT14280A	UFT14280D			
		30	0.47	TO-249 Flat Pack	FST16230	FST16230A	FST16230D		
35		250	0.55	TwinTower	CPT50235	CPT50235A	CPT50235D		
40		300	0.65		CPT60035	CPT60035A	CPT60035D		
		150	0.76		CPT30040	CPT30040A	CPT30040D		
45		40	0.53	Mini-Mod	FST8145	FST8145A	FST8145D		
			80	0.65	TO-249 Flat Pack	FST16145	FST16145A	FST16145D	
			80	0.74		FST16045	FST16045A	FST16045D	
			100	0.68	TwinTower	CPT20145	CPT20145A	CPT20145D	
			150	0.62		CPT30145	CPT30145A	CPT30145D	
			150	0.77		CPT30045	CPT30045A	CPT30045D	
	200	0.57	CPT40145	CPT40145A		CPT40145D			
	250	0.55	CPT50145	CPT50145A		CPT50145D			
	300	0.55	CPT60145	CPT60145A		CPT60145D			
	50	60	0.8	TO-249 Flat Pack	CPT60045	CPT60045A	CPT60045D		
			0.65		CPT12050	CPT12050A	CPT12050D		
		80	0.74	TO-249 Flat Pack	FST16050	FST16050A	FST16050D		
60		150	0.78	TwinTower	CPT30050	CPT30050A	CPT30050D		
	0.82		CPT30060		CPT30060A	CPT30060D			
	250	0.73	CPT50060		CPT50060A	CPT50060D			
	200	0.89	CPT40080		CPT40080A	CPT40080D			
90	80	0.96	TO-249 Flat Pack	FST16090	FST16090A	FST16090D			
		150	0.98	TwinTower	CPT30090	CPT30090A	CPT30090D		
	200	0.90	TwinTower	CPT40090	CPT40090A	CPT40090D			
	100	40	0.82	Mini-Mod	FST80100	FST80100A	FST80100D		
60			0.86	TO-249 Flat Pack	FST60100	FST60100A	FST60100D		
75		0.94	TO-249 Flat Pack	FST153100	FST153100A	FST153100D			
80		0.96	TO-249 Flat Pack	FST160100	FST160100A	FST160100D			
150		150	0.98	Twin Tower	CPT300100	CPT300100A	CPT300100D		
			0.91		CPT400100	CPT400100A	CPT400100D		
		200	0.90		CPT500100	CPT500100A	CPT500100D		
		250	0.90		CPT600100	CPT600100A	CPT600100D		
150	300	0.85		CPT600150	CPT600150A	CPT600150D			



**Non Isolated Packages**

SM1 SM3 SM5  
SM2 SM4 SM6

x option for Mini-Mod Surface Mount Package

Mini-Mod Surface Mount

Mini-Mod

TO-249 Flat Pack

Twin Tower Non Isolated

10-pin TO-249



# Package Outlines

Pin out location depends on the module configuration. Please refer to the product datasheet for pins assignment. All dimensions in millimeters.

## D<sup>3</sup> Pak or TO-268

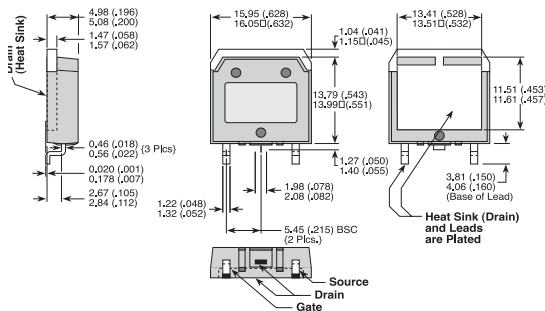

## TO-220 [KF]

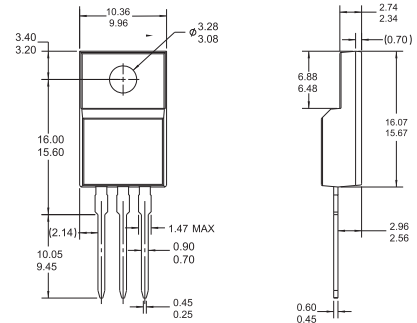

## TO-220 2-Lead

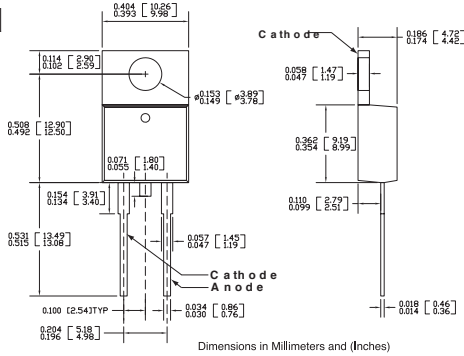

## TO-220 3-Lead

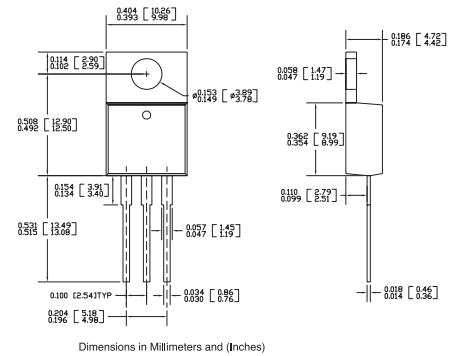

## TO-247 3-Lead

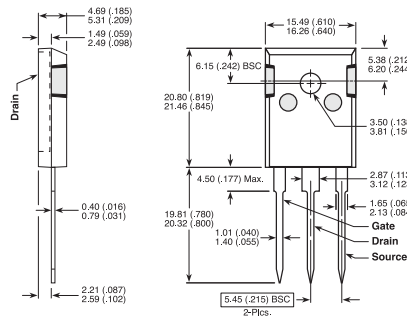

## TO-247 2-Lead

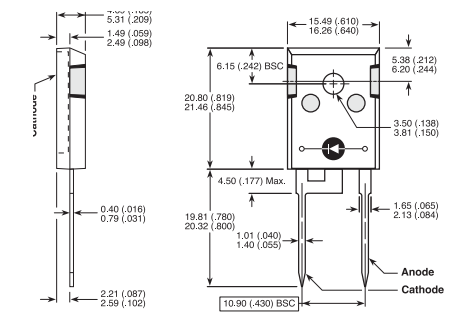

## T-MAX<sup>®</sup>

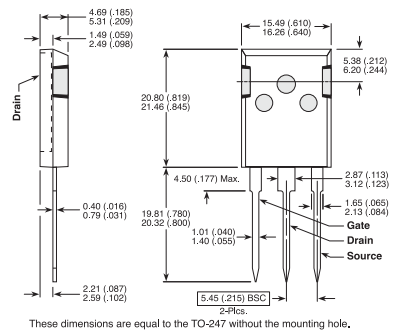

## TO-264

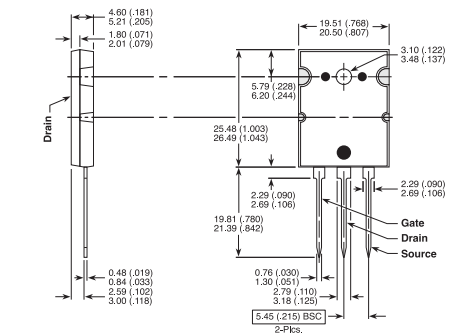

## 264 MAX<sup>™</sup>

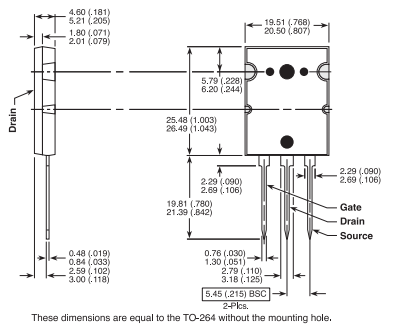

## ISOTOP<sup>®</sup> or SOT-227

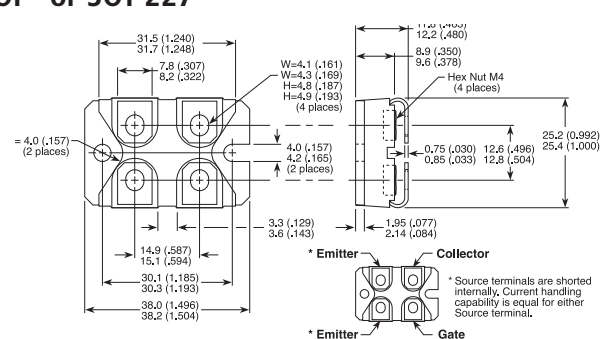

# Power Module Outlines

Pin out location depends on the module configuration. Please refer to the product datasheet for pins assignment. All dimensions in millimeters.

D1

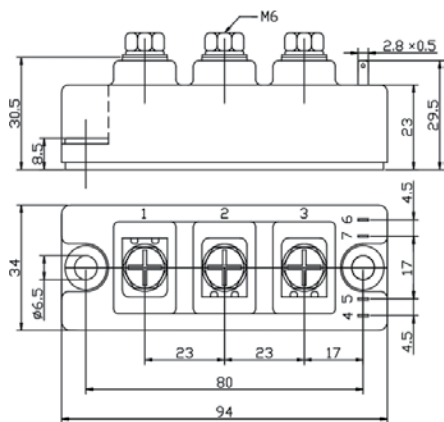

D3

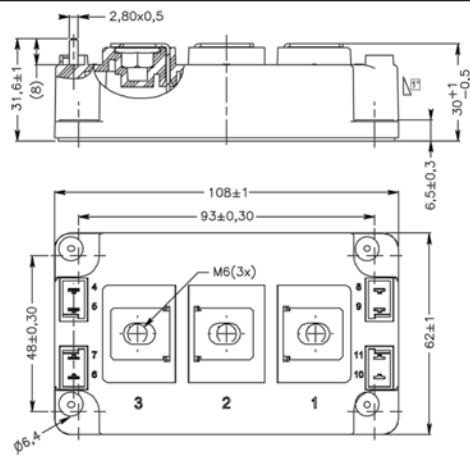

D4

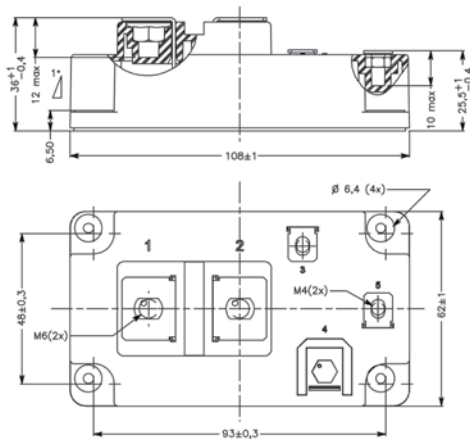

LP4

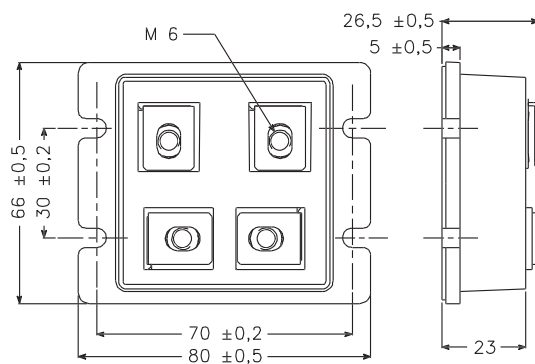

LP8

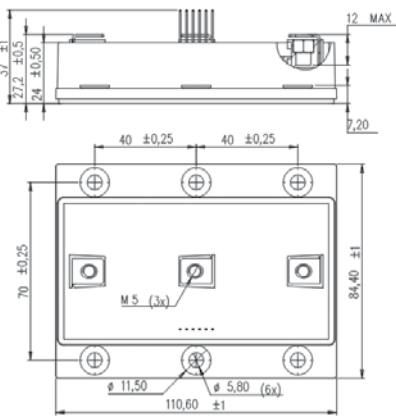

SP1

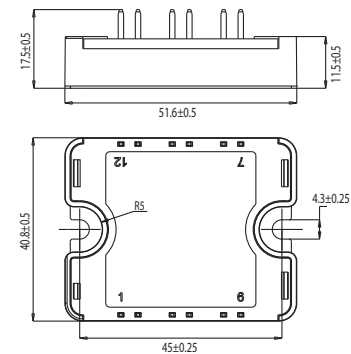

SP2

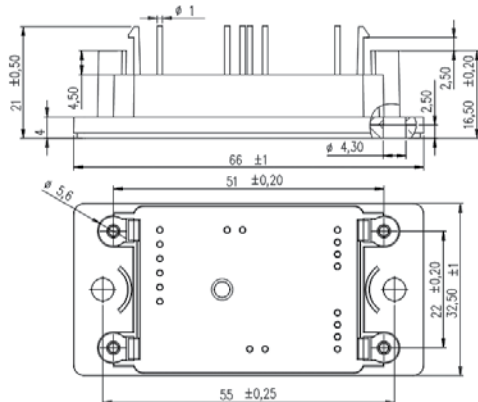

SP3

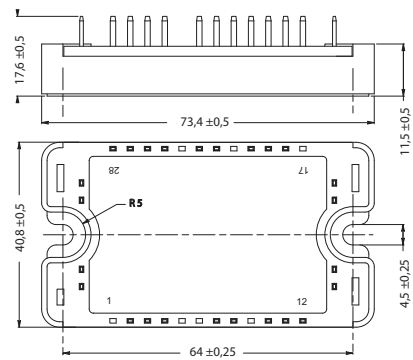

# Power Module Outlines

SP3F

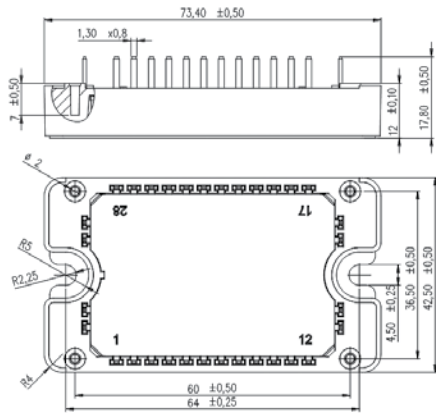

SF1

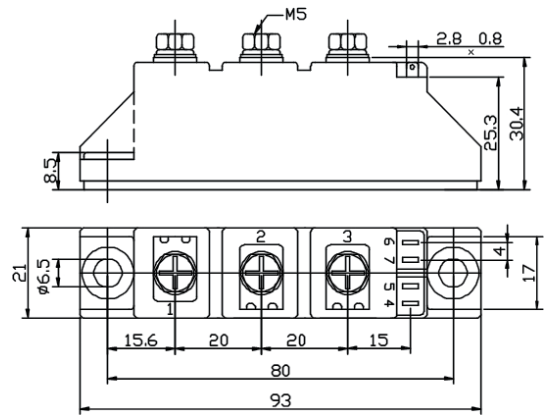

SP4

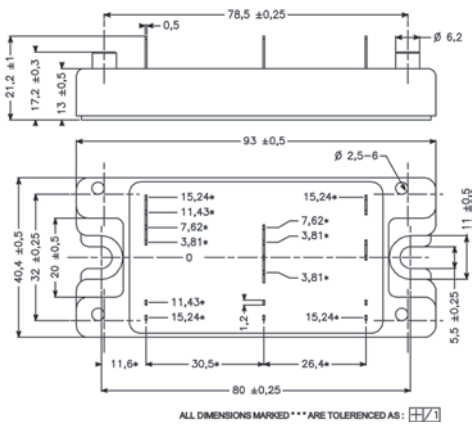

SP6 - 3 outputs

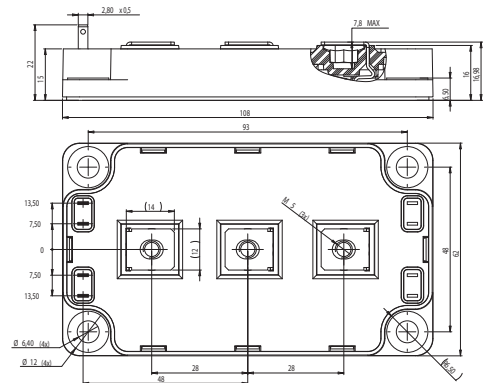

SP6 - 4 outputs

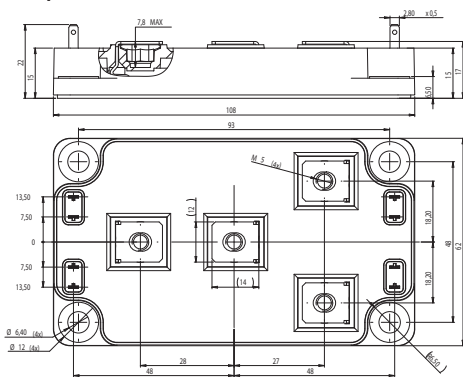

SP6 3-Level

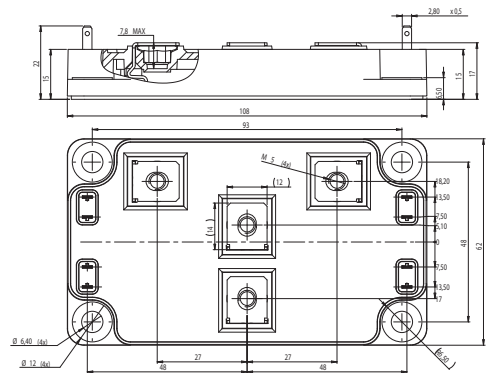

SP6-P

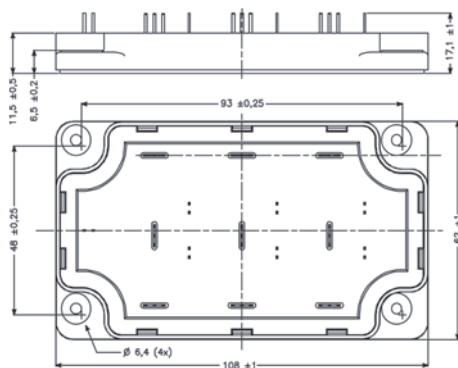

SD1

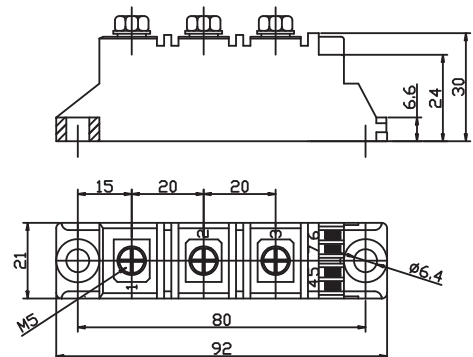

# Power Module Outlines

Pin out location depends on the module configuration. Please refer to the product datasheet for pins assignment. All dimensions in millimeters.

SD2

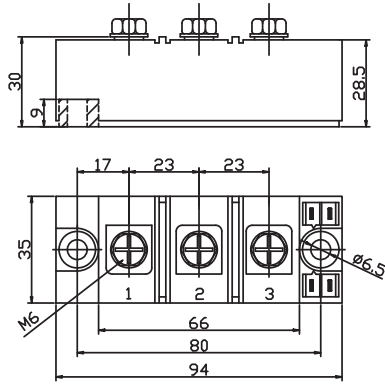

SM1

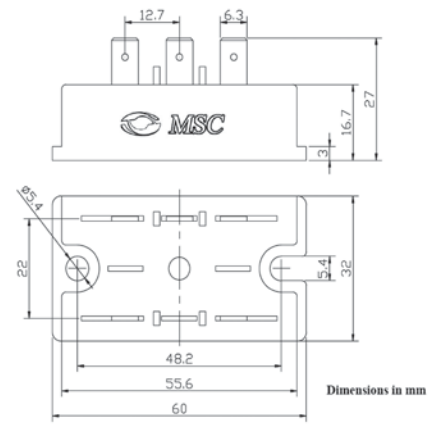

SM2

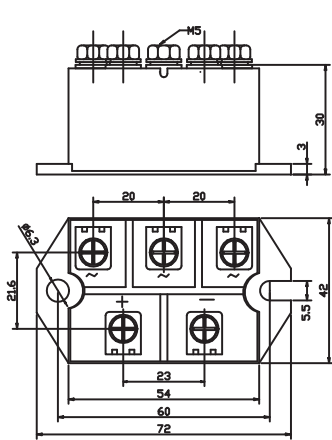

SM2-1

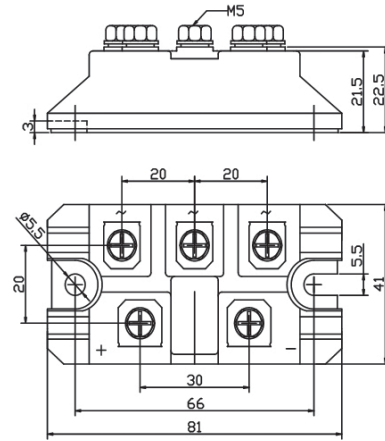

SM3

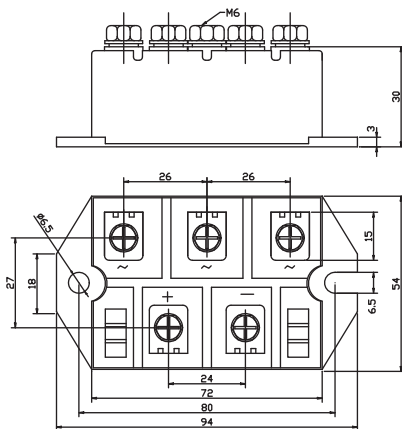

SM3-1

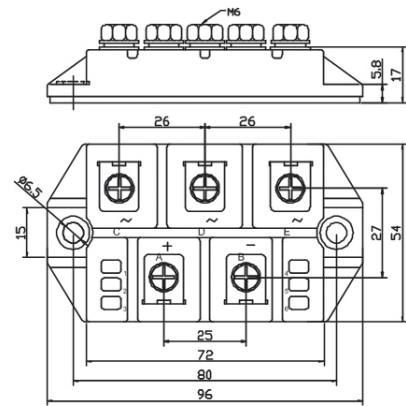

SM4

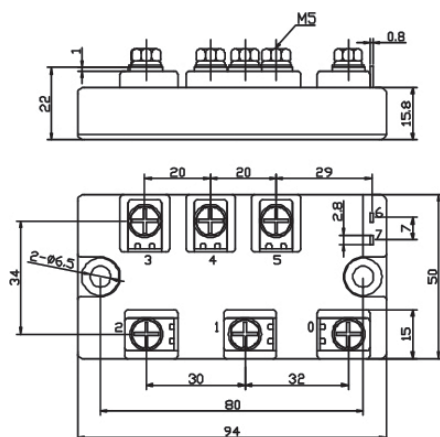

SM5

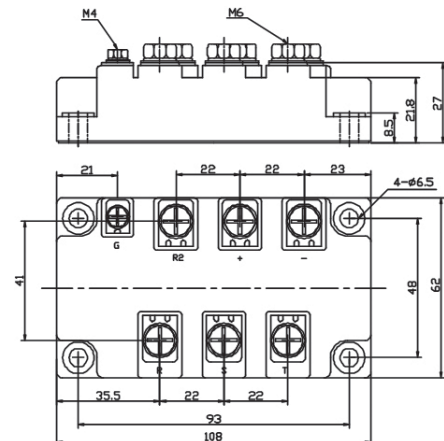

# Power Module Outlines

Pin out location depends on the module configuration. Please refer to the product datasheet for pins assignment. All dimensions in millimeters.

## SDM

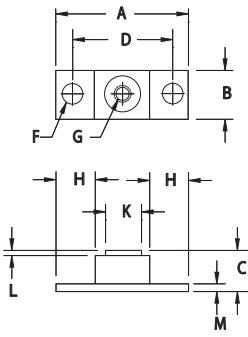

Dim.	Inches		Millimeters		Notes
	Min.	Max.	Min.	Max.	
A	---	2.650	---	67.31	
B	1.240	1.260	31.49	32.00	
C	---	.925	---	23.49	
D	---	2.00 BSC	---	50.80 BSC	
F	0.320	0.340	8.13	8.64	Dia.
G	---	---	---	---	5/16-18 UNC
H	0.630	---	16.00	---	
K	0.610	0.640	15.49	16.26	
L	---	.100	---	2.54	
M	0.182	0.192	4.62	4.88	

Standard Polarity: Base plate is cathode  
Reverse Polarity: Base plate is anode

## VJ

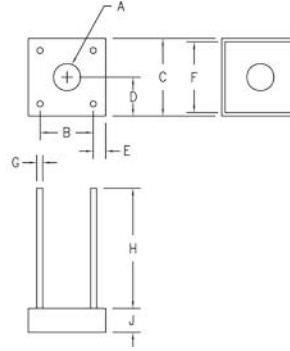

Dim.	Inches		Millimeter		Notes
	Minimum	Maximum	Minimum	Maximum	
A	.137	.167	3.84	2.21	Dia.
B	.411	.441	10.44	11.20	
C	.600	.620	---	---	
D	.295	.310	---	---	
E	.076	.096	---	---	
F	.545	.555	13.85	14.10	
G	.076	.096	.970	1.07	
H	---	1.0 Min.	---	25.40 Min.	
J	.195	.215	4.95	5.46	

## Mini-Mod Surface Mount

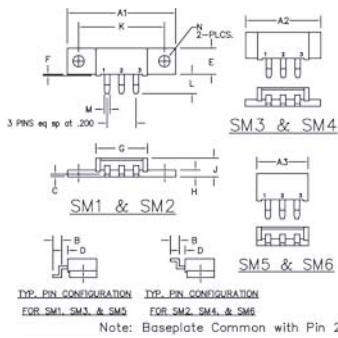

Dim.	Inches		Millimeter		Notes
	Minimum	Maximum	Minimum	Maximum	
A1	1.490	1.510	37.85	38.35	
A2	1.020	1.040	26.12	26.42	
A3	.695	.715	17.65	18.16	
B	.110	.120	2.79	3.04	
C	.027	.037	0.69	0.94	
D	.100	.110	2.54	2.79	
E	.350	.370	8.89	9.40	
F	.015	.025	0.38	0.64	
G	.695	.715	17.65	18.16	
H	.088	.098	2.24	2.49	
J	.240	.260	6.10	6.60	
K	1.180	1.195	29.97	30.35	
L	.230	.250	5.84	6.35	
M	.065	.085	1.65	2.16	
N	.151	.161	3.84	4.09	Dia.

Note: Baseplate Common with Pin 2

## Mini-Mod

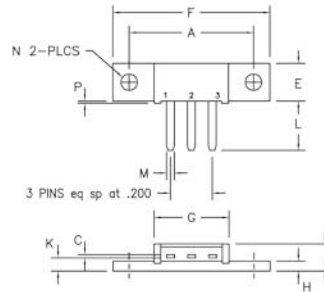

Dim.	Inches		Millimeter		Notes
	Minimum	Maximum	Minimum	Maximum	
A	1.180	1.195	29.97	30.35	
C	.027	.037	0.69	0.94	
E	.350	.370	8.89	9.40	
F	1.490	1.510	37.85	38.35	
G	.695	.715	17.65	18.16	
H	.088	.098	2.24	2.49	
J	.240	.260	6.10	6.60	
K	.115	.135	2.92	3.43	
L	.460	.480	11.68	12.19	
M	.065	.085	1.65	2.16	
N	.151	.161	3.84	4.09	Dia.
P	.015	.025	0.38	0.64	

## TO-249

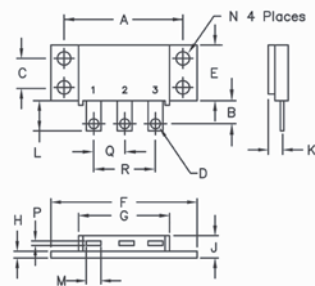

Dim.	Inches		Millimeters		Notes
	Min.	Max.	Min.	Max.	
A	1.995	2.005	50.67	50.93	
B	0.300	0.325	7.62	8.26	
C	0.495	0.505	12.57	12.83	
D	0.182	0.192	4.62	4.88	Dia.
E	0.990	1.010	25.15	25.65	
F	2.390	2.410	60.71	61.21	
G	1.500	1.525	38.10	38.70	
H	0.120	0.130	3.05	3.30	
J	---	0.400	---	10.16	
K	0.240	0.260	6.10	6.60 to Lead $\phi$	
L	0.490	0.510	12.45	12.95	
M	0.330	0.350	8.38	6.90	
N	0.175	0.195	4.45	4.95	Dia.
P	0.035	0.045	0.89	1.14	
Q	0.445	0.455	11.30	11.56	
R	0.890	0.910	22.61	23.11	

## 9 Pin TO-249

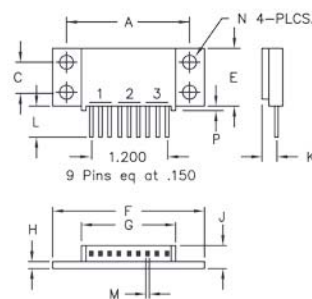

Dim.	Inches		Millimeter		Notes
	Minimum	Maximum	Minimum	Maximum	
A	1.995	2.005	50.67	50.93	
C	0.495	0.506	12.57	12.83	
E	0.990	1.010	25.15	25.65	
F	2.390	2.410	60.71	61.21	
G	1.490	1.510	37.85	38.35	
H	0.120	0.130	3.05	3.30	
J	---	0.400	---	10.16	
K	0.240	0.260	6.10	6.60 to Lead $\phi$	
L	0.490	0.510	12.45	12.95	
M	0.040	.050	1.02	1.27	Square Dia
N	0.175	0.195	4.45	4.95	Dia
P	0.032	0.052	0.81	1.32	

## Twin Tower

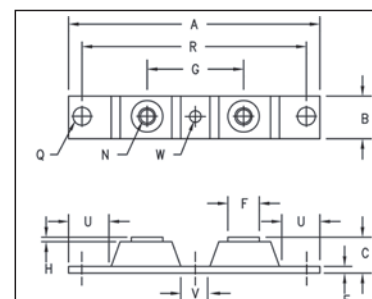

Dim.	Inches		Millimeters		Notes
	Min.	Max.	Min.	Max.	
A	---	3.630	---	92.20	
B	0.700	0.800	17.78	20.32	
C	---	0.630	---	16.00	
E	0.120	0.130	3.05	3.30	
F	0.490	0.510	12.45	12.95	
G	---	1.375 BSC	---	34.92 BSC	
H	0.010	---	0.25	---	
N	---	---	---	---	
Q	0.275	0.290	6.99	7.37	
R	---	3.150 BSC	---	80.01 BSC	
U	0.600	---	15.24	---	
V	0.312	0.340	7.92	8.64	
W	0.180	0.195	4.57	4.95	

## Half Pak

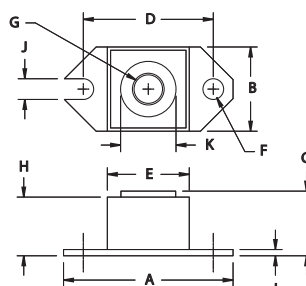

Dim.	Inches		Millimeter		Notes
	Minimum	Maximum	Minimum	Maximum	
A	1.52	1.56	38.61	39.62	
B	.725	.775	18.42	19.69	
C	.605	.625	15.37	15.88	
D	1.182	1.192	30.02	30.28	
E	.745	.755	18.92	19.18	
F	.152	.160	3.86	4.06	Sq. Dia.
G	---	1/4-20 UNC-2B	---	---	
H	.525	.580	13.34	14.73	
J	.156	.160	3.96	4.06	
K	.495	.505	12.57	12.83	Dia.
L	.120	.130	3.05	3.30	

Std. Polarity: Base is cathode  
Rev. Polarity: Base is anode



### **Power Semiconductor Products**

405 SW Columbia Street  
Bend, Oregon 97702  
Tel: 541-382-8028  
Toll Free USA: 800-522-0809  
Fax: 541-388-0364

### **Power Modules**

26 rue de Campilleau  
33520 Bruges - France  
Tel: +33-557 921515  
Fax: +33-556 479761

### **Microsemi Corporate Office**

One Enterprise  
Aliso Viejo, CA 92656  
Tel: 949-380-6100  
Toll Free USA: 800-713-4113  
Fax: 949-215-4996

### **Sales Offices**

#### **China-Shenzhen**

Room A, 17/F, Noble Center  
No. 1006, 3rd Fuzhong Road, Futian District  
Shenzhen 518026, China  
Tel: +86-755-82028976  
Fax: +86-755-82028977

#### **China-Shanghai**

Room 405, No.318, Fuzhou RD,  
HuangPu district, Shanghai, China  
Tel: +86 21-63612788  
Fax: +86 21-63612790

#### **Hong Kong**

7/F, Meeco Industrial Bldg  
53-55 Au Pui Wan St.  
Fotan, Shatin, NT., Kong Kong  
Tel: +852-2692 1202  
Fax: +852-2691 0544

#### **Japan**

EXOS Ebisu Bldg. 4F,  
1-24-14 Ebisu, Shibuya-ku,  
Tokyo 150-0013, Japan  
Tel: +81-3-53263008  
Fax: +81-3-53263001

#### **Korea**

Room# 906, SeochoTown Trapalace, 1327,  
Seocho-2dong, Seocho-gu,  
Seoul, Korea (Zip Code 137-973)  
Tel: +82-2-522-2631  
Fax: +82 31 783 2674

#### **Taiwan**

10F-A, No. 105, Sec 2, Dun Hua S. Rd.  
Taipei 106, Taiwan, R.O.C  
Tel: +886-2-6636 6588  
Fax: +886-2-2701 9051

#### **Asia-Pacific Rim**

Tel: +886-2-6636-6588  
E-Mail: [rsmasia@microsemi.com](mailto:rsmasia@microsemi.com)

#### **Eastern North America**

Tel: (716) 699-5626  
E-Mail: [rsmeast@microsemi.com](mailto:rsmeast@microsemi.com)

#### **Central North America**

Tel: (214) 763-4666  
E-Mail: [rsmcen@microsemi.com](mailto:rsmcen@microsemi.com)

#### **Western North America**

Tel: (408) 307-9373  
E-Mail: [rsmwest@microsemi.com](mailto:rsmwest@microsemi.com)

#### **Europe, Middle East, Africa**

Tel: +32-12-453 465  
E-Mail: [rsmeurope@microsemi.com](mailto:rsmeurope@microsemi.com)