

## Boost chopper MOSFET Power Module

$V_{DSS} = 200V$   
 $R_{DSon} = 8m\Omega$  typ @  $T_j = 25^\circ C$   
 $I_D = 208A$  @  $T_c = 25^\circ C$

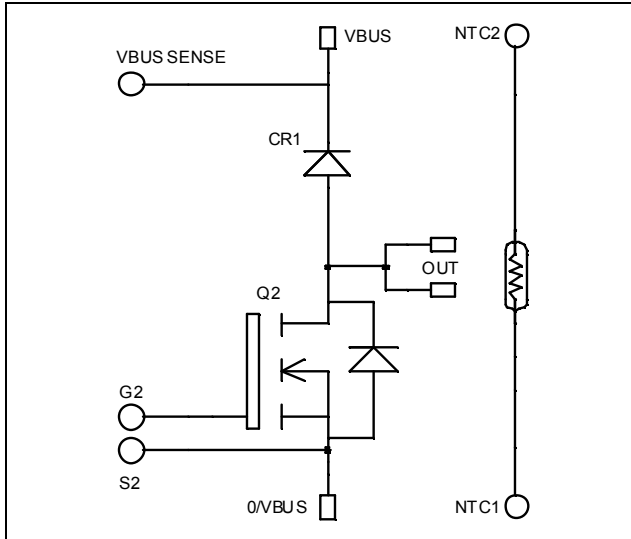

### Application

- AC and DC motor control
- Switched Mode Power Supplies
- Power Factor Correction

### Features

- Power MOS 7<sup>®</sup> MOSFETs
  - Low  $R_{DSon}$
  - Low input and Miller capacitance
  - Low gate charge
  - Avalanche energy rated
  - Very rugged
- Kelvin source for easy drive
- Very low stray inductance
  - Symmetrical design
  - Lead frames for power connections
- Internal thermistor for temperature monitoring
- High level of integration

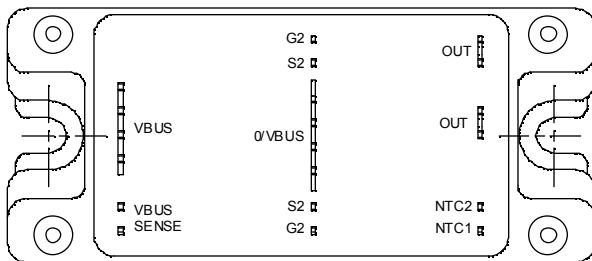

### Benefits

- Outstanding performance at high frequency operation
- Direct mounting to heatsink (isolated package)
- Low junction to case thermal resistance
- Solderable terminals both for power and signal for easy PCB mounting
- Low profile
- RoHS compliant

### Absolute maximum ratings

Symbol	Parameter	Max ratings	Unit
$V_{DSS}$	Drain - Source Breakdown Voltage	200	V
$I_D$	Continuous Drain Current	$T_c = 25^\circ C$	208
		$T_c = 80^\circ C$	155
$I_{DM}$	Pulsed Drain current	832	A
$V_{GS}$	Gate - Source Voltage	$\pm 30$	V
$R_{DSon}$	Drain - Source ON Resistance	10	$m\Omega$
$P_D$	Maximum Power Dissipation	$T_c = 25^\circ C$	781
$I_{AR}$	Avalanche current (repetitive and non repetitive)	100	A
$E_{AR}$	Repetitive Avalanche Energy	50	mJ
$E_{AS}$	Single Pulse Avalanche Energy	3000	

**CAUTION:** These Devices are sensitive to Electrostatic Discharge. Proper Handling Procedures Should Be Followed. See application note APT0502 on [www.microsemi.com](http://www.microsemi.com)

All ratings @  $T_j = 25^\circ\text{C}$  unless otherwise specified

**Electrical Characteristics**

Symbol	Characteristic	Test Conditions	Min	Typ	Max	Unit
$I_{DSS}$	Zero Gate Voltage Drain Current	$V_{GS} = 0V, V_{DS} = 200V$			150	$\mu\text{A}$
		$T_j = 25^\circ\text{C}$				
		$V_{GS} = 0V, V_{DS} = 160V$			750	
$R_{DS(on)}$	Drain – Source on Resistance	$V_{GS} = 10V, I_D = 104A$		8	10	$\text{m}\Omega$
$V_{GS(th)}$	Gate Threshold Voltage	$V_{GS} = V_{DS}, I_D = 5mA$	3		5	V
$I_{GSS}$	Gate – Source Leakage Current	$V_{GS} = \pm 30V, V_{DS} = 0V$			$\pm 150$	nA

**Dynamic Characteristics**

Symbol	Characteristic	Test Conditions	Min	Typ	Max	Unit
$C_{iss}$	Input Capacitance	$V_{GS} = 0V$		14.4		nF
$C_{oss}$	Output Capacitance	$V_{DS} = 25V$		4.66		
$C_{rss}$	Reverse Transfer Capacitance	$f = 1\text{MHz}$		0.29		
$Q_g$	Total gate Charge	$V_{GS} = 10V$		280		nC
$Q_{gs}$	Gate – Source Charge	$V_{Bus} = 100V$		106		
$Q_{gd}$	Gate – Drain Charge	$I_D = 208A$		134		
$T_{d(on)}$	Turn-on Delay Time	<b>Inductive switching @ <math>125^\circ\text{C}</math></b>		32		ns
$T_r$	Rise Time	$V_{GS} = 15V$		64		
$T_{d(off)}$	Turn-off Delay Time	$V_{Bus} = 133V$		88		
$T_f$	Fall Time	$I_D = 208A$ $R_G = 2.5\Omega$		116		
$E_{on}$	Turn-on Switching Energy	<b>Inductive switching @ <math>25^\circ\text{C}</math></b>		1698		$\mu\text{J}$
$E_{off}$	Turn-off Switching Energy	$V_{GS} = 15V, V_{Bus} = 133V$ $I_D = 208A, R_G = 2.5\Omega$		1858		
$E_{on}$	Turn-on Switching Energy	<b>Inductive switching @ <math>125^\circ\text{C}</math></b>		1872		$\mu\text{J}$
$E_{off}$	Turn-off Switching Energy	$V_{GS} = 15V, V_{Bus} = 133V$ $I_D = 208A, R_G = 2.5\Omega$		1972		

**Chopper diode ratings and characteristics**

Symbol	Characteristic	Test Conditions	Min	Typ	Max	Unit
$V_{RRM}$	Maximum Peak Repetitive Reverse Voltage		200			V
$I_{RM}$	Maximum Reverse Leakage Current	$V_R = 200V$	$T_j = 25^\circ\text{C}$		500	$\mu\text{A}$
			$T_j = 125^\circ\text{C}$		750	
$I_F$	DC Forward Current			180		A
$V_F$	Diode Forward Voltage	$I_F = 180A$		1.1	1.15	V
		$I_F = 360A$		1.4		
		$I_F = 180A$	$T_j = 125^\circ\text{C}$	0.9		
$t_{rr}$	Reverse Recovery Time	$I_F = 180A$	$T_j = 25^\circ\text{C}$	31		ns
			$T_j = 125^\circ\text{C}$	60		
$Q_{rr}$	Reverse Recovery Charge	$V_R = 133V$ $di/dt = 600A/\mu\text{s}$	$T_j = 25^\circ\text{C}$	180		nC
			$T_j = 125^\circ\text{C}$	750		

## Thermal and package characteristics

Symbol	Characteristic		Min	Typ	Max	Unit
R <sub>thJC</sub>	Junction to Case Thermal Resistance	Transistor			0.16	°C/W
		Diode			0.32	
V <sub>ISOL</sub>	RMS Isolation Voltage, any terminal to case t = 1 min, I <sub>isol</sub> < 1 mA, 50/60 Hz		2500			V
T <sub>J</sub>	Operating junction temperature range		-40		150	°C
T <sub>STG</sub>	Storage Temperature Range		-40		125	
T <sub>C</sub>	Operating Case Temperature		-40		100	
Torque	Mounting torque	To Heatsink	M5	2.5	4.7	N.m
Wt	Package Weight				160	g

## Temperature sensor NTC (see application note APT0406 on www.microsemi.com for more information).

Symbol	Characteristic	Min	Typ	Max	Unit
R <sub>25</sub>	Resistance @ 25°C		50		kΩ
B <sub>25/85</sub>	T <sub>25</sub> = 298.15 K		3952		K

$$R_T = \frac{R_{25}}{\exp\left[B_{25/85}\left(\frac{1}{T_{25}} - \frac{1}{T}\right)\right]}$$

T: Thermistor temperature  
 R<sub>T</sub>: Thermistor value at T

## SP4 Package outline (dimensions in mm)

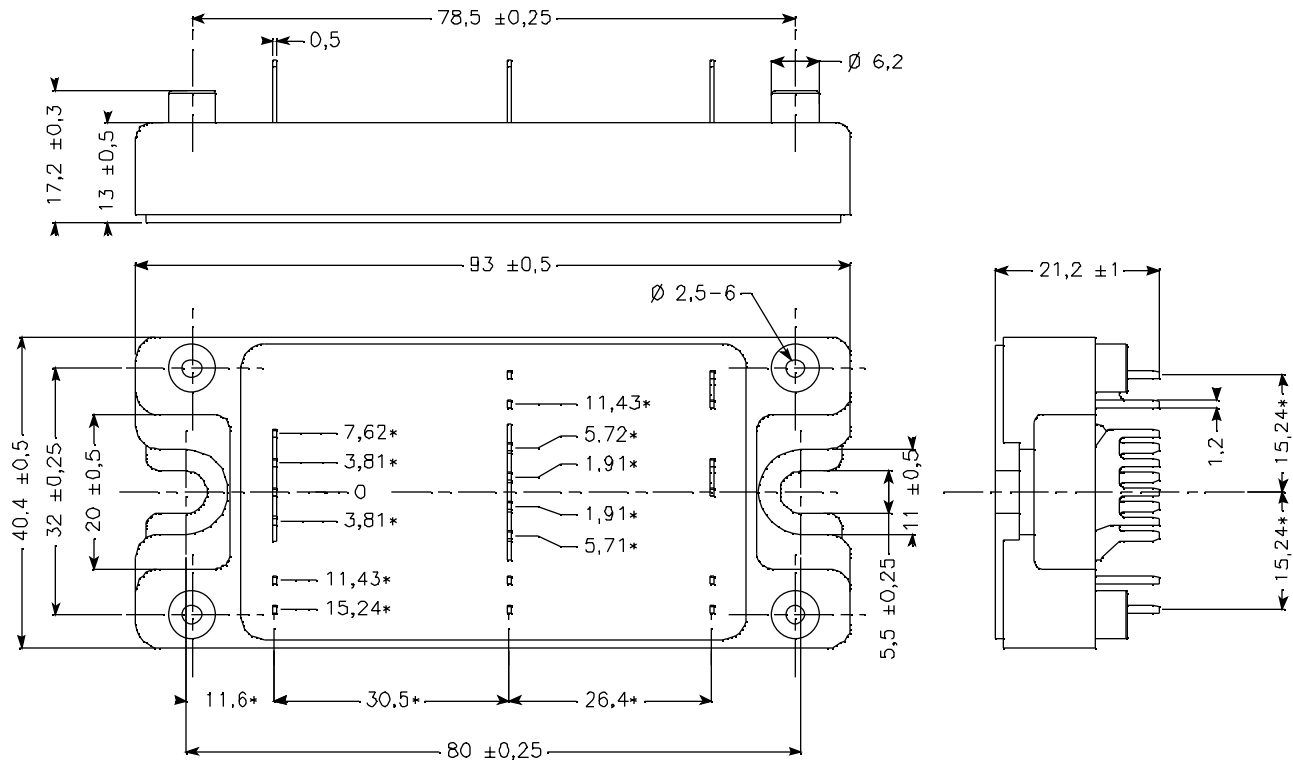

ALL DIMENSIONS MARKED "\*" ARE TOLERANCED AS:  $\boxed{\oplus \ominus 0,1}$

See application note APT0501 - Mounting Instructions for SP4 Power Modules on [www.microsemi.com](http://www.microsemi.com)

## Typical Performance Curve

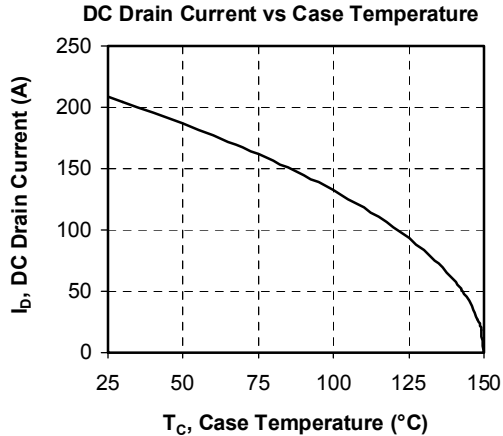
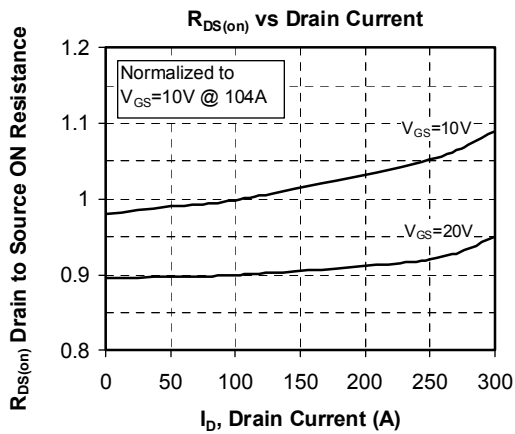
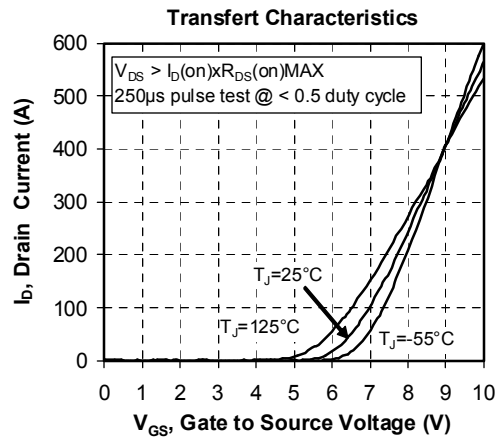
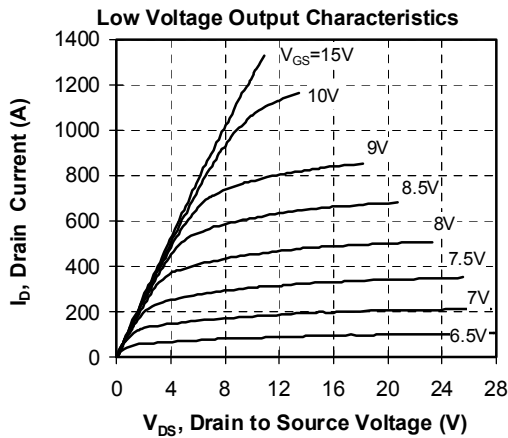
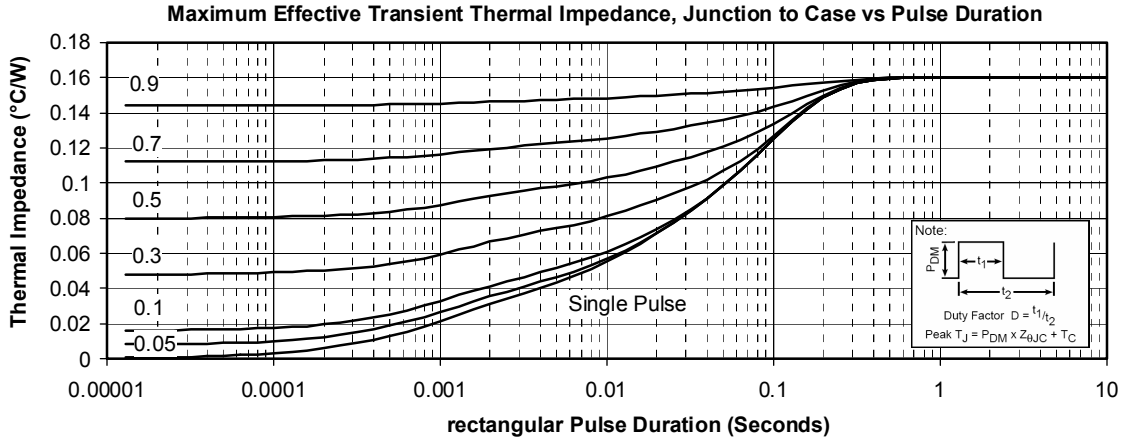

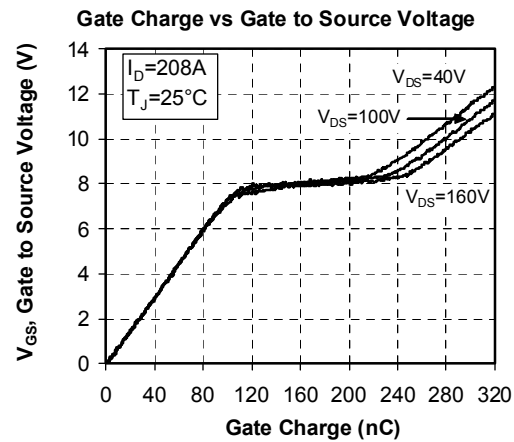
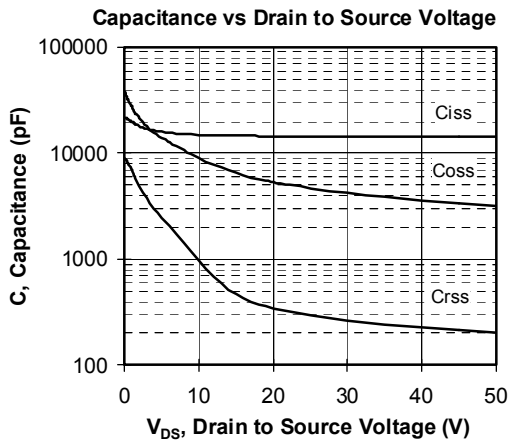
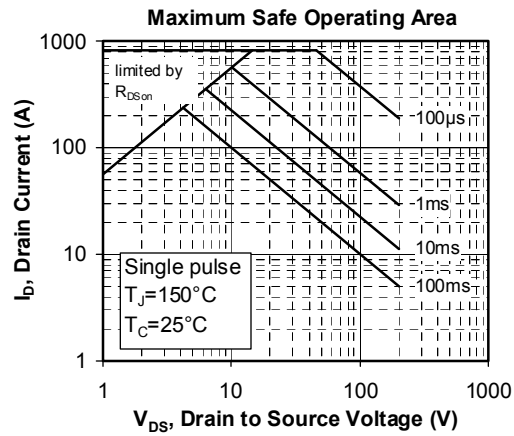
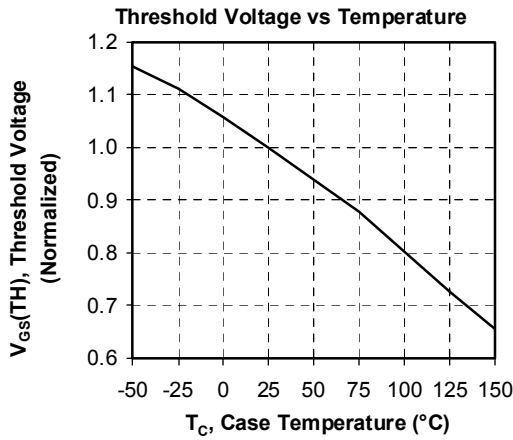
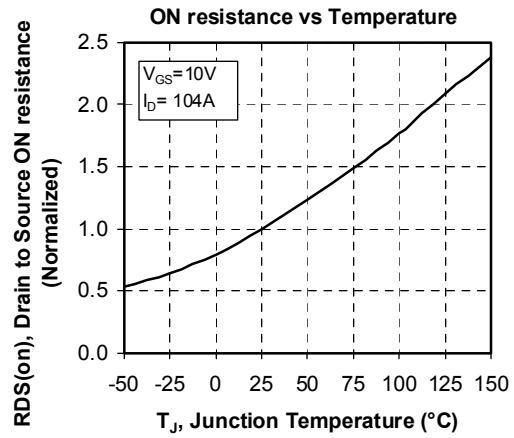

**Delay Times vs Current**

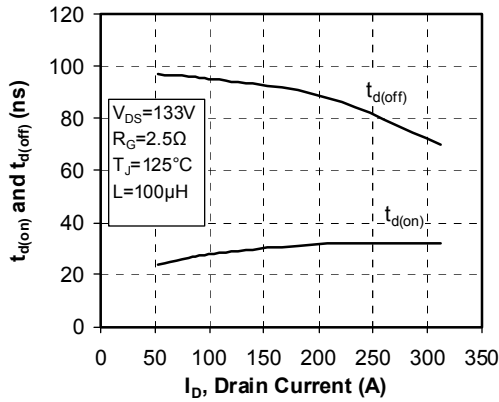

**Rise and Fall times vs Current**

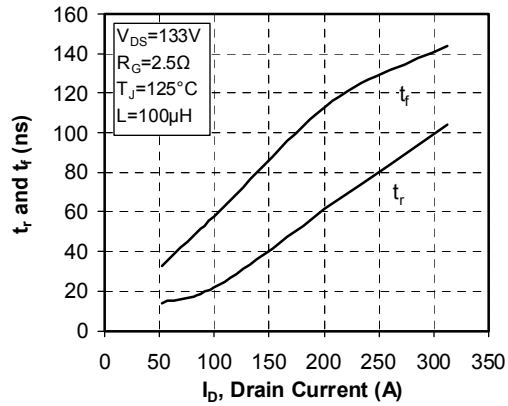

**Switching Energy vs Current**

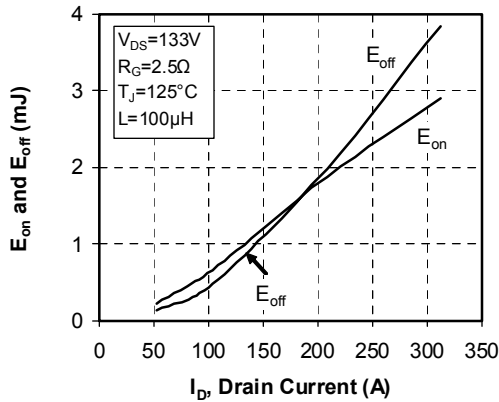

**Switching Energy vs Gate Resistance**

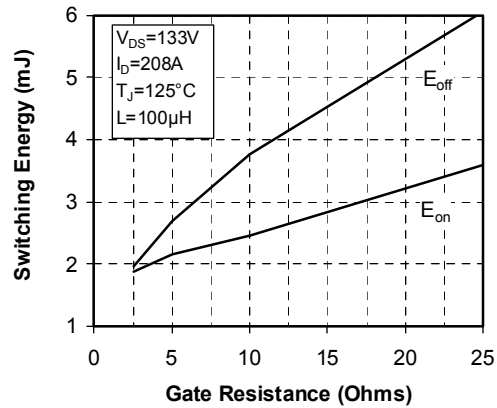

**Operating Frequency vs Drain Current**

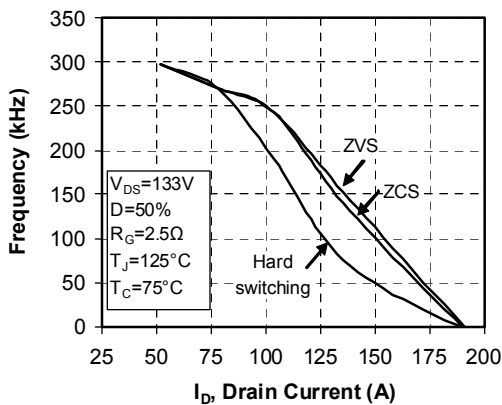

**Source to Drain Diode Forward Voltage**

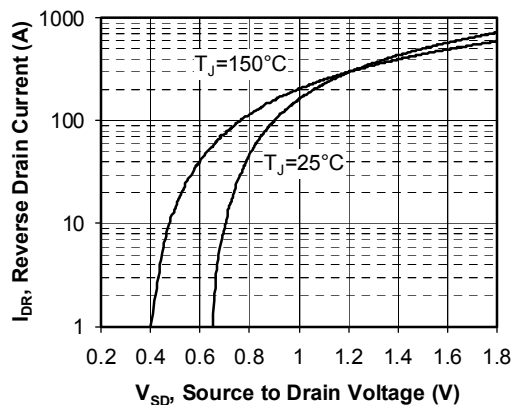

Microsemi reserves the right to change, without notice, the specifications and information contained herein

Microsemi's products are covered by one or more of U.S. patents 4,895,810 5,045,903 5,089,434 5,182,234 5,019,522 5,262,336 6,503,786 5,256,583 4,748,103 5,283,202 5,231,474 5,434,095 5,528,058 and foreign patents. U.S. and Foreign patents pending. All Rights Reserved.