

NAIS

POWER PhotoMOS RELAYS with Internal Varistor

PhotoMOS RELAYS

FEATURES

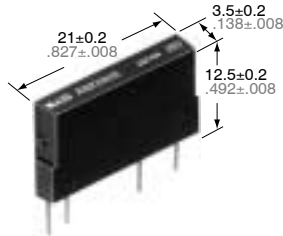

mm inch

1. Power PhotoMOS relay with internal varistor

An internal varistor on the output side protects the output MOSFET from the reverse voltage from an external voltage surge or inductive load.

2. High capacity PhotoMOS relay

Supports control of minute loads to a maximum 3.0 A. Suitable for output control.

3. Supports both AC and DC

Bi-directional control so there is no need to differentiate according to the load as in conventional SSR's.

4. Can be placed on-board the 4-unit relay (power photoMOS relay type)

5. Ideal for inductive loads

Ideal for inductive loads such as motors, solenoids, and electro-magnetic contactors.

6. High sensitivity, low ON resistance

Can control a maximum 3.0 A load with a 5 mA input current. Low On resistance of 0.18 Ω (AQZ202V).

7. Compact slim-type 4-pin SIL

(W) 3.5x(L) 21.0x(H) 12.5 mm (W) .138x(L) .827x(H) .492 inch. The compact 73.5mm² size of the 4-pin SIL package allows high density mounting.

8. Sockets also available

9. Promoting the CE making
(Please inquire for further details.)

TYPES

AC/DC type

Output rating			Part No.	Packing quantity	
Load voltage (Effective Vrms)	Load current	Inner carton		Outer carton	
17 V AC	22 V DC	3.0 A	AQZ202V	25 pcs.	500 pcs.
30 V AC	38 V DC	2.0 A	AQZ205V		
60 V AC	85 V DC	1.0 A	AQZ207V		
140 V AC	180 V DC	0.5 A	AQZ204V		

Note: Refer to the recommended load voltage.

RATING

AC/DC type

1) Absolute maximum ratings (Ambient temperature: 25°C 77°F)

Item		Symbol	AQZ202V	AQZ205V	AQZ207V	AQZ204V	Remarks
Input	LED forward current	I _F	50 mA				
	LED reverse voltage	V _R	3 V				
	Peak forward current	I _{FP}	1 A				f = 100 Hz, Duty factor = 0.1%
	Power dissipation	P _{in}	75 mW				
Output	Load voltage	AC	17 V	30 V	60 V	140 V	Effective Vrms
		DC	22 V	38 V	85 V	180 V	
	Continuous load current (Peak AC)	I _L	3.0 A	2.0 A	1.0 A	0.5 A	
	Peak load current	I _{peak}	9.0 A	6.0 A	3.0 A	1.5 A	100 ms (1 shot), V _L = DC
	Power dissipation	P _{out}	1.6 W				
Total power dissipation		P _T	1.6 W				
I/O isolation voltage		V _{iso}	2,500 V AC				
Temperature limits	Operating	T _{opr}	-40°C to +85°C -40°F to +185°F				Non-condensing at low temperatures
	Storage	T _{stg}	-40°C to +100°C -40°F to +212°F				

AQZ200V

2) Electrical characteristics (Ambient temperature: 25°C 77°F)

Item		Symbol	AQZ202V	AQZ205V	AQZ207V	AQZ204V	Remarks	
Input	LED operate current	Typical	1.0 mA				$I_L = 100 \text{ mA}$ $V_L = 10 \text{ V}$	
		Maximum	3.0 mA					
	LED turn off current	Minimum	0.4 mA				$I_L = 100 \text{ mA}$ $V_L = 10 \text{ V}$	
		Typical	0.9 mA					
LED dropout voltage	Typical	1.25 V (1.16 V at $I_F = 10 \text{ mA}$)				$I_F = 50 \text{ mA}$		
	Maximum	1.5 V						
Output	On resistance	Typical	0.11 Ω	0.23 Ω	0.7 Ω	2.1 Ω	$I_F = 10 \text{ mA}$ $I_L = \text{Max.}$ Within 1 s on time	
		Maximum	0.18 Ω	0.34 Ω	1.1 Ω	3.2 Ω		
	Off state leakage current	Maximum	1 mA				$I_F = 0$ $V_L = \text{Max. DC}$	
Transfer characteristics	Switching speed	Turn on time*	Typical	2.46 ms	2.40 ms	1.12 ms	1.65 ms	$I_F = 10 \text{ mA}$ $I_L = 100 \text{ mA}$ $V_L = 10 \text{ V}$
			Maximum	5.0 ms				
		Typical	5.64 ms	5.65 ms	2.57 ms	3.88 ms	$I_F = 5 \text{ mA}$ $I_L = 100 \text{ mA}$ $V_L = 10 \text{ V}$	
		Maximum	10.0 ms					
	Turn off time*	Typical	0.22 ms	0.21 ms	0.10 ms	0.08 ms	$I_F = 5 \text{ mA or } 10 \text{ mA}$ $I_L = 100 \text{ mA}$ $V_L = 10 \text{ V}$	
		Maximum	3.0 ms					
	I/O capacitance	Typical	0.8 pF				$f = 1 \text{ MHz}$ $V_B = 0$	
		Maximum	1.5 pF					
	Initial I/O isolation resistance	Minimum	R_{iso}	1,000 M Ω			500 V DC	
	Maximum operating frequency	Maximum	—	1.0 cps			$I_F = 10 \text{ mA}$ Duty factor = 50% $I_L = \text{Max.}, V_L = \text{Max.}$	
Vibration resistance	Minimum	—	10 to 55 Hz at double amplitude of 3 mm			2 hours for 3 axes		
Shock resistance	Minimum	—	4,900 m/s ² {500 G} 1 ms			3 times for 3 axes		

3) Internal varistor characteristics

Item	AQZ202V	AQZ205V	AQZ207V	AQZ204V
Varistor voltage	27 V	47 V	100 V	220 V
Maximum energy	0.5 J	1.0 J	2.0 J	4.5 J

Note: When using the relay to absorb the reverse voltage during inductive load switching, make sure the load is within the inductance range given in the internal varistor characteristics data below, rather than the energy resistance range for the internal varistor. Note, the inductance range will differ if the switching frequency is higher than the rate given for the characteristics data conditions.

Note: Recommendable LED forward current $I_F = 5$ to 10 mA.

*Turn on/off time

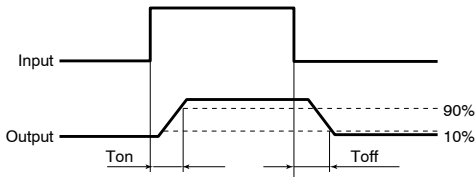

- For Dimensions, see Page 442.
- For Schematic and Wiring Diagrams, see Page 448.
- For Cautions for Use, see Page 453.

REFERENCE DATA

1. Load current vs. ambient temperature characteristics

Allowable ambient temperature: -40°C to +85°C
-40°F to +185°F

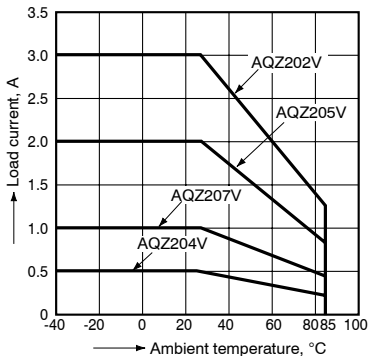

2. Load current vs. ambient temperature characteristics in adjacent mounting

I_L : Load current;
 I_L (max.): Maximum continuous load current

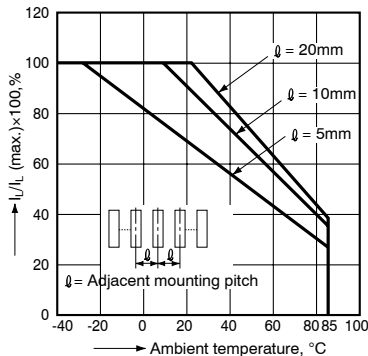

3.-(1) On resistance vs. ambient temperature characteristics

LED current: 10 mA;
Continuous load current: 3.0 A (DC) (AQZ202V),
2.0 A (DC) (AQZ205V),

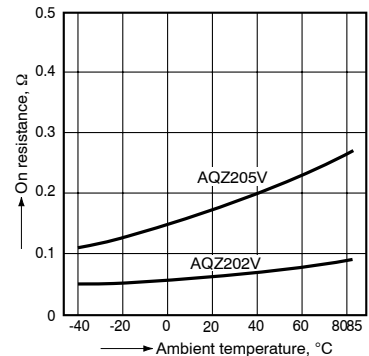

3.-(2) On resistance vs. ambient temperature characteristics

LED current: 10 mA;
 Continuous load current: 3.0 A (DC) (AQZ202V),
 2.0 A (DC) (AQZ205V),

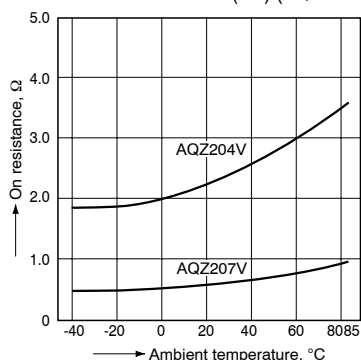

4. Turn on time vs. ambient temperature characteristics

LED current: 10 mA;
 Load voltage: 10 V (DC)
 Continuous load current: 100 mA (DC)

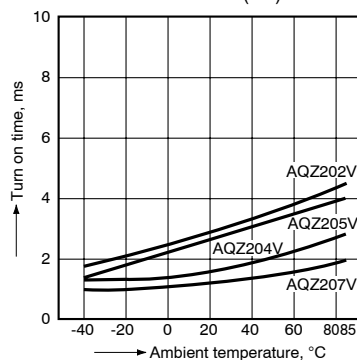

5. Turn off time vs. ambient temperature characteristics

LED current: 10 mA;
 Load voltage: 10 V (DC)
 Continuous load current: 100 mA (DC)

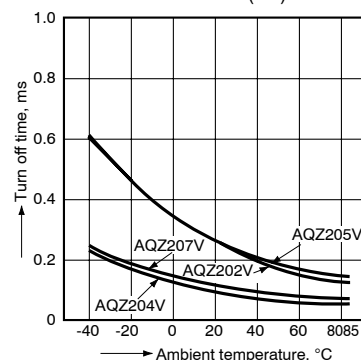

6. LED operate vs. ambient temperature characteristics

Load voltage: 10 V (DC);
 Continuous load current: 100 mA (DC)

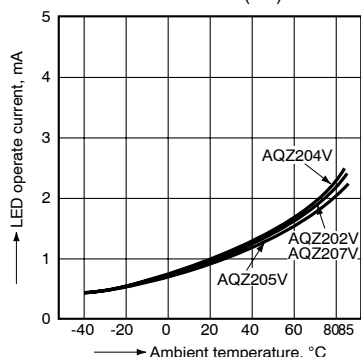

7. LED turn off current vs. ambient temperature characteristics

Load voltage: 10 V (DC)
 Continuous load current: 100 mA (DC)

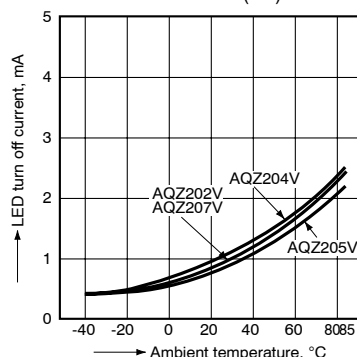

8. LED dropout voltage vs. ambient temperature characteristics

Sample: all types; LED current: 5 to 50 mA

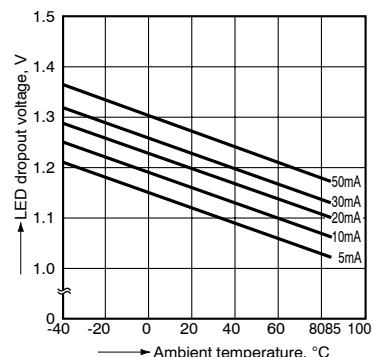

9. Voltage vs. current characteristics of output at MOS portion

Ambient temperature: 25°C 77°F

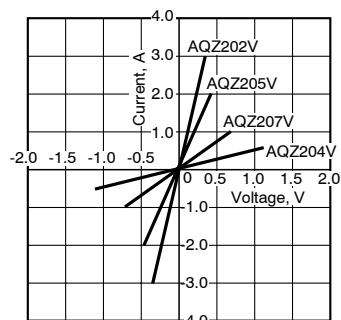

10. Off state leakage current

Ambient temperature: 25°C 77°F

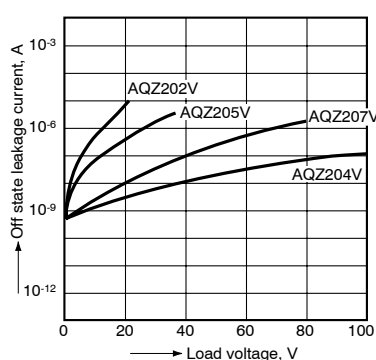

11. LED forward current vs. turn on time characteristics

Load voltage: 10 V (DC); Continuous load current: 100 mA (DC); Ambient temperature: 25°C 77°F

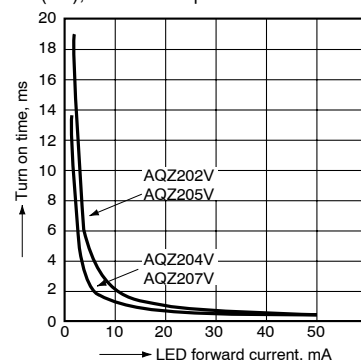

12. LED forward current vs. turn off time characteristics

Load voltage: 10 V (DC); Continuous load current: 100 mA (DC); Ambient temperature: 25°C 77°F

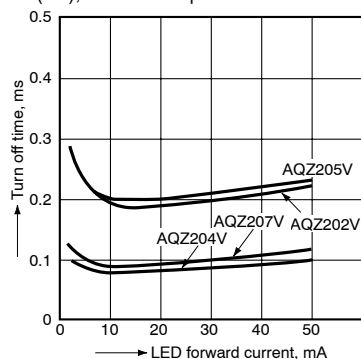

13. Maximum operating frequency vs. load voltage/current characteristics

LED current: 10 mA
 Ambient temperature: 25°C 77°F

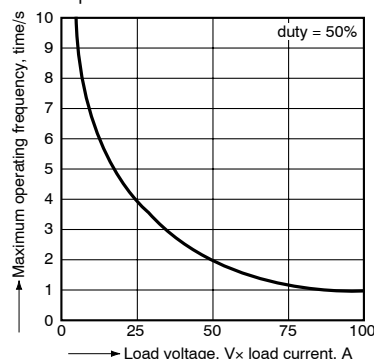

14. Applied voltage vs. output capacitance characteristics

Frequency: 1 MHz;
 Ambient temperature: 25°C 77°F

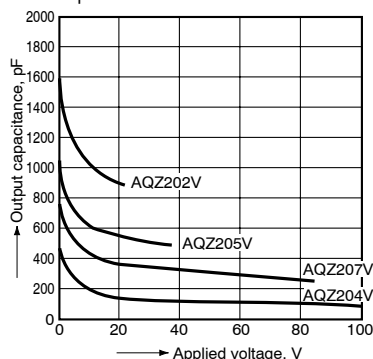

AQZ200V

15. Data for internal varistor characteristic

Operating frequency: 1 Hz
No. of operations: 10⁶ max.

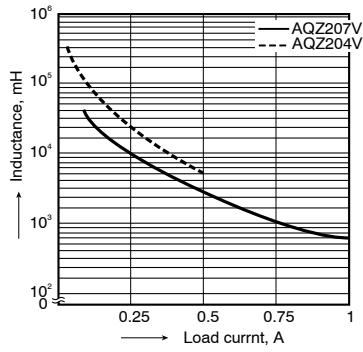
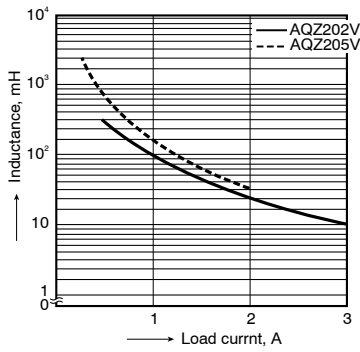

ACCESSORY

mm inch

For more details, please consult our nearest office.

Socket Standard type

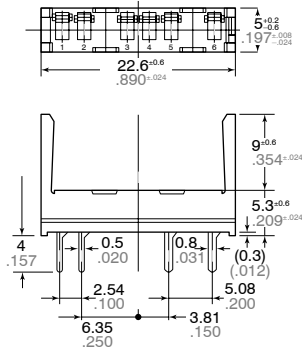

PA1a-PS

Self clinching type

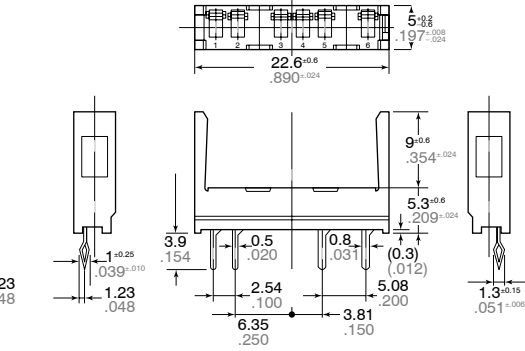

PA1a-PS-H

PC board pattern (BOTTOM VIEW)
Standard type

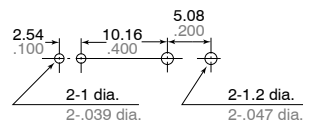

Self clinching type

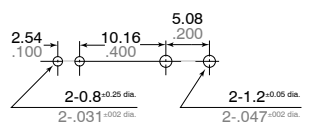

Tolerance: ±0.1 ±.004