

High Current Button Rectifiers

FEATURES

- Diffused junction
- Low leakage
- High surge capability
- Low cost construction utilizing void-free molded plastic technique
- Compliant to RoHS Directive 2011/65/EU and in accordance to WEEE 2002/96/EC
- Halogen-free according to IEC 61249-2-21 definition

AR

MECHANICAL DATA

Case: AR

Molding compound, UL flammability classification rating 94V-0

Base P/N with suffix "G" on packing code - green compound (halogen-free)

Terminal: Matte tin plated leads, solderable per JESD22-B102

Meet JESD 201 class 1A whisker test

Weight: 1.8 g (approximately)

| MAXIMUM RATINGS AND ELECTRICAL CHARACTERISTICS (T _A =25°C unless otherwise noted) | | | | | | | | | |
|--|--------------------|--------------|--------|--------|--------|--------|--------|--------|------|
| PARAMETER | SYMBOL | AR 35A | AR 35B | AR 35D | AR 35G | AR 35J | AR 35K | AR 35M | UNIT |
| Maximum repetitive peak reverse voltage | V _{RRM} | 50 | 100 | 200 | 400 | 600 | 800 | 1000 | V |
| Maximum RMS voltage | V _{RMS} | 35 | 70 | 140 | 280 | 420 | 560 | 700 | V |
| Maximum DC blocking voltage | V _{DC} | 50 | 100 | 200 | 400 | 600 | 800 | 1000 | V |
| Maximum average forward rectified current | I _{F(AV)} | 35 | | | | | | | A |
| Peak forward surge current, 8.3 ms single half sine-wave superimposed on rated load | I _{FSM} | 500 | | | | | | | A |
| Maximum instantaneous forward voltage (Note 1) @ 35 A | V _F | 1.0 | | | | | | | V |
| Maximum reverse current @ Rated VR T _J =25 °C T _J =125 °C | I _R | 5 250 | | | | | | | μA |
| Typical reverse recovery time (Note 2) | trr | 3 | | | | | | | μs |
| Typical junction capacitance (Note 3) | C _j | 300 | | | | | | | pF |
| Typical Thermal Resistance | R _{θJC} | 1 | | | | | | | °C/W |
| Operating junction temperature range | T _J | - 50 to +175 | | | | | | | °C |
| Storage temperature range | T _{STG} | - 50 to +175 | | | | | | | °C |

Note 1: Pulse test with PW=300μs, 1% duty cycle

 Note 2: Reverse Recovery Time Test Conditions: I_F=0.5A, I_R=1.0A, I_{RR}=0.25A

Note 3: Measured at 1 MHz and Applied Reverse Voltage of 4.0V D.C.

ORDERING INFORMATION

| PART NO. | PACKING CODE | PACKING CODE SUFFIX | PACKAGE | PACKING |
|-------------------|--------------|---------------------|---------|----------------------|
| AR35x (Note 1) | B0 | G | AR | 1,000 / Bulk packing |

Note 1: "x" defines voltage from 50V (AR35A) to 1000V (AR35M)

EXAMPLE

| PREFERRED P/N | PART NO. | PACKING CODE | PACKING CODE SUFFIX | DESCRIPTION |
|---------------|----------|--------------|---------------------|----------------|
| AR35M B0 | AR35M | B0 | | |
| AR35M B0G | AR35M | B0 | G | Green compound |

RATINGS AND CHARACTERISTICS CURVES

($T_A=25^\circ\text{C}$ unless otherwise noted)

FIG. 1- MAXIMUM FORWARD CURRENT DERATING CURVE

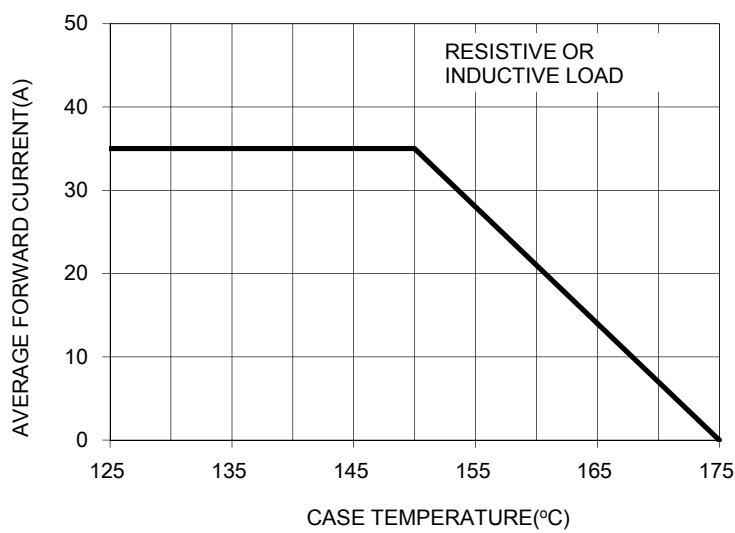

FIG. 2- TYPICAL REVERSE CHARACTERISTICS

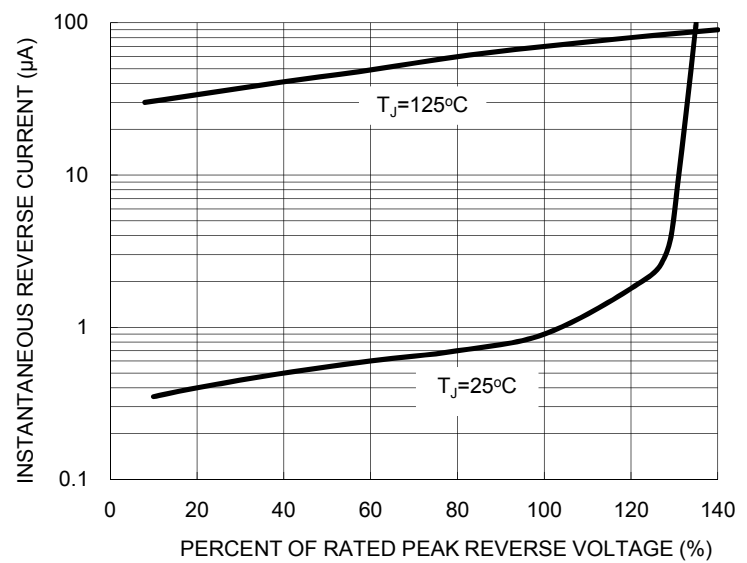

FIG. 3- MAXIMUM NON-REPETITIVE PEAK FORWARD SURGE CURRENT

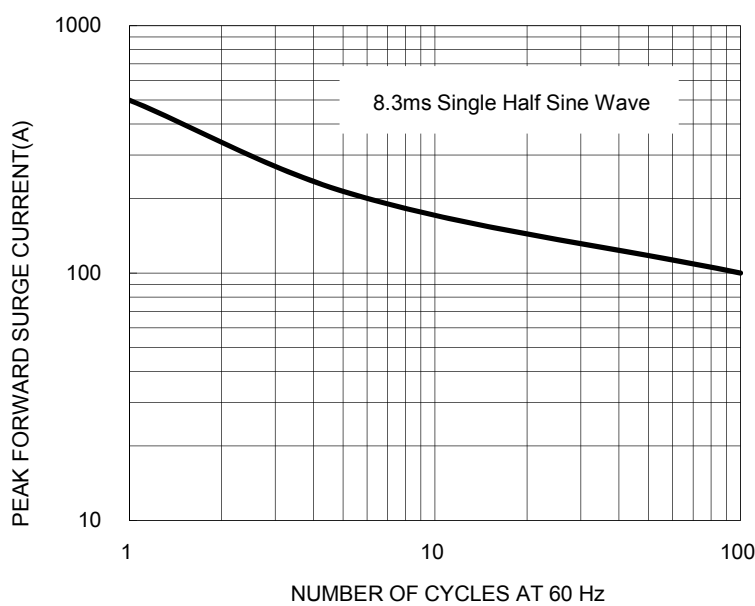

Fig. 4 TYPICAL FORWARD CHARACTERISTICS

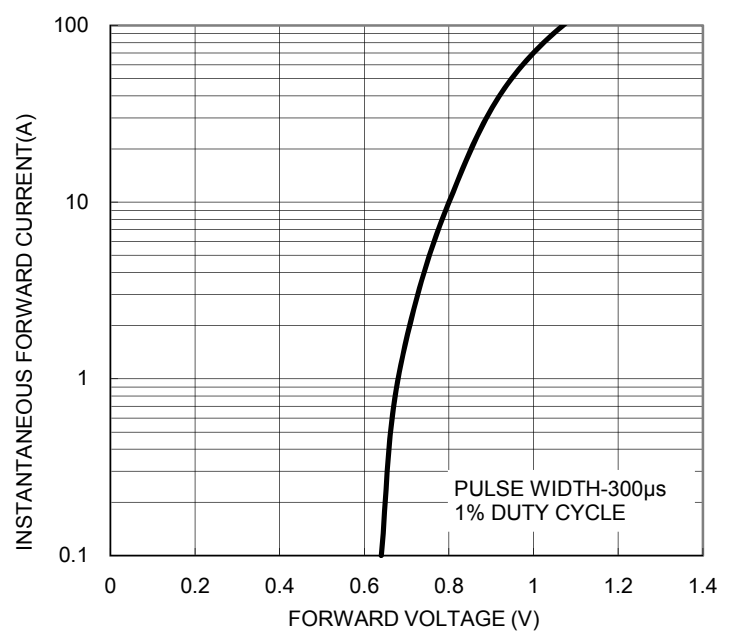

FIG. 5 TYPICAL JUNCTION CAPACITANCE

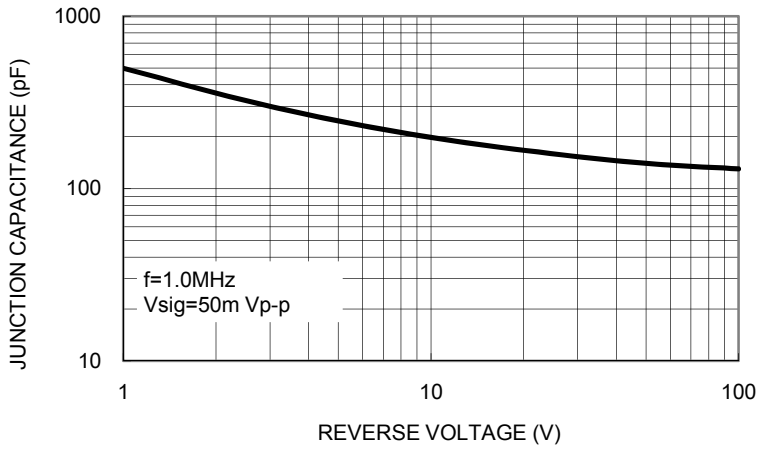
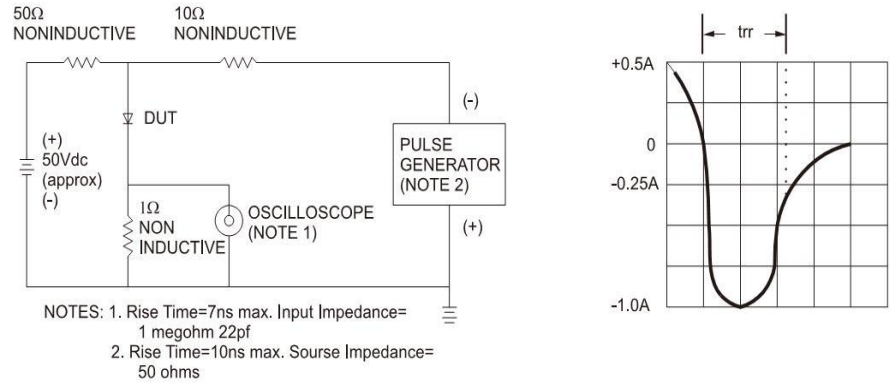

FIG.6- REVERSE RECOVERY TIME CHARACTERISTIC AND TEST CIRCUIT DIAGRAM



PACKAGE OUTLINE DIMENSIONS



| DIM. | Unit (mm) | | Unit (inch) | |
|------|-----------|-------|-------------|-------|
| | Min | Max | Min | Max |
| A | 5.50 | 5.70 | 0.217 | 0.224 |
| B | 9.70 | 10.40 | 0.382 | 0.409 |
| C | 6.00 | 6.40 | 0.236 | 0.252 |
| D | 4.20 | 4.70 | 0.165 | 0.185 |

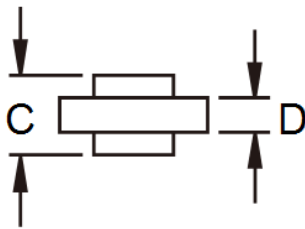

MARKING DIAGRAM



P/N = Specific Device Code
G = Green Compound
YW = Date Code
F = Factory Code

Notice

Specifications of the products displayed herein are subject to change without notice. TSC or anyone on its behalf, assumes no responsibility or liability for any errors inaccuracies.

Information contained herein is intended to provide a product description only. No license, express or implied, to any intellectual property rights is granted by this document. Except as provided in TSC's terms and conditions of sale for such products, TSC assumes no liability whatsoever, and disclaims any express or implied warranty, relating to sale and/or use of TSC products including liability or warranties relating to fitness for a particular purpose, merchantability, or infringement of any patent, copyright, or other intellectual property right.

The products shown herein are not designed for use in medical, life-saving, or life-sustaining applications. Customers using or selling these products for use in such applications do so at their own risk and agree to fully indemnify TSC for any damages resulting from such improper use or sale.