

ANSALDO**Ansaldo Trasporti
s.p.a.**Via N. Lorenzi 8 - I 16152 GENOVA -
ITALY
Tel. int. +39/(0)10 6556549 - (0)10
6556488
Fax int. +39/(0)10 6442540**FAST RECOVERY DIODE****ARF220**Repetitive voltage up to **1400 V**
Mean forward current **445 A**
Surge current **5 kA****FINAL SPECIFICATION**

ott 97 - ISSUE : 02

| Symbol | Characteristic | Conditions | T _j [°C] | Value | Unit |
|---|-------------------------------------|--|------------------------|-----------|------------------|
| BLOCKING | | | | | |
| V _{RRM} | Repetitive peak reverse voltage | | 125 | 1400 | V |
| V _{RSM} | Non-repetitive peak reverse voltage | | 125 | 1500 | V |
| I _{RRM} | Repetitive peak reverse current | V=VRRM | 125 | 50 | mA |
| CONDUCTING | | | | | |
| I _{F(AV)} | Mean forward current | 180° sin ,50 Hz, Th=55°C, double side cooled | | 445 | A |
| I _{F(AV)} | Mean forward current | 180° square,50 Hz,Th=55°C,double side cooled | | 440 | A |
| I _{FSM} | Surge forward current | Sine wave, 10 ms | 125 | 4.5 | kA |
| I ² t | I ² t | reapplied reverse voltage up to 50% VRSM | | 101 x1E3 | A ² s |
| V _{FM} | Forward voltage | Forward current 300 A | 125 | 1.18 | V |
| V _{F(TO)} | Threshold voltage | | 125 | 1.00 | V |
| r _F | Forward slope resistance | | 125 | 0.60 | mohm |
| SWITCHING | | | | | |
| t _{rr} | Reverse recovery time | I _F = 200 A | 125 | 2.5 | μs |
| Q _{rr} | Reverse recovery charge | di/dt = 40 A/μs | | 80 | μC |
| I _{rr} | Peak reverse recovery current | VR = 50 V | | 70 | A |
| s | Softness (s-factor), min | | | 0.4 | |
| V _{FR} | Peak forward recovery | di/dt = 400 A/μs | | | V |
| MOUNTING | | | | | |
| R _{th(j-h)} | Thermal impedance | Junction to heatsink, double side cooled | | 95 | °C/kW |
| T _j | Operating junction temperature | | | -30 / 125 | °C |
| F | Mounting force | | | 4.5 ,5.0 | kN |
| | Mass | | | 55 | g |
| ORDERING INFORMATION : ARF220 S 14 | | | | | |
| standard specification <input type="checkbox"/> <input type="checkbox"/> VRRM/100 | | | | | |

DISSIPATION CHARACTERISTICS

SQUARE WAVE

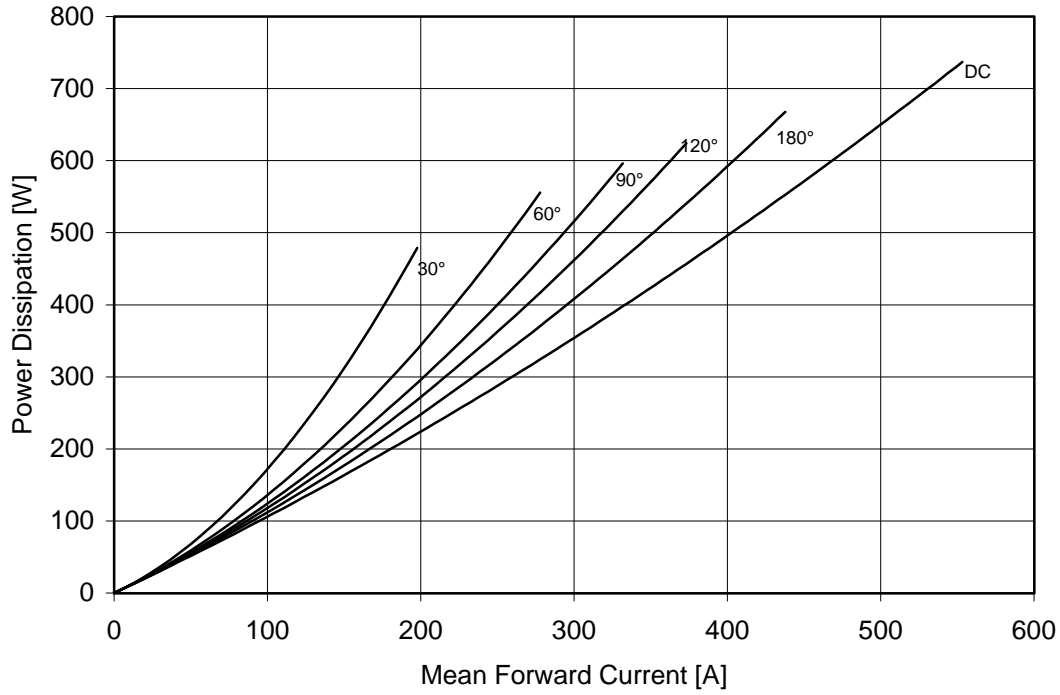

SINE WAVE

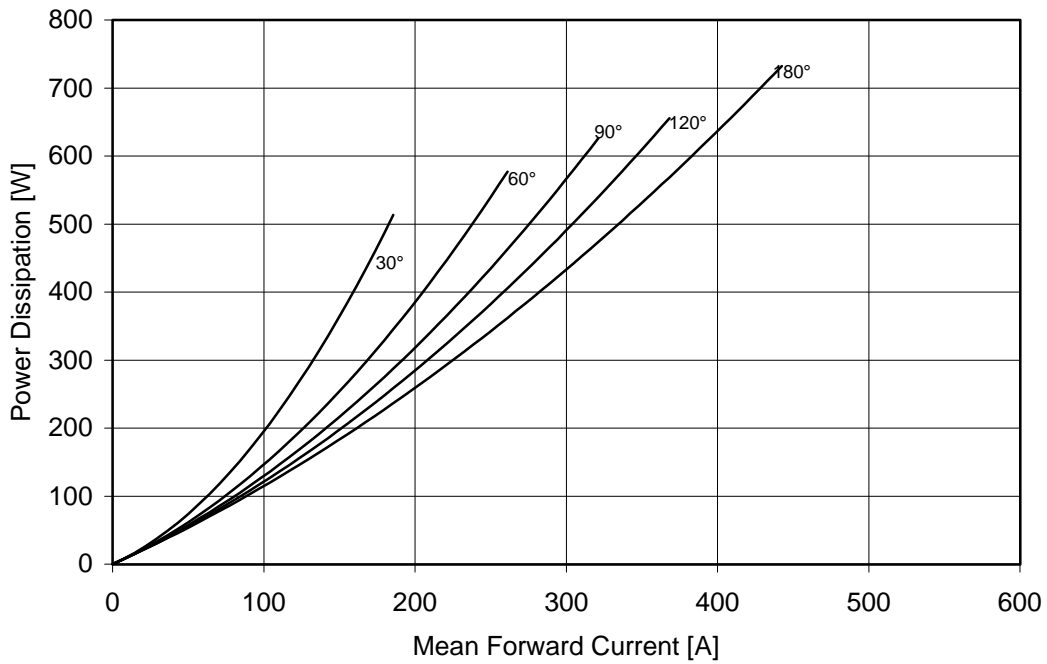

SWITCHING CHARACTERISTICS

FORWARD RECOVERY VOLTAGE

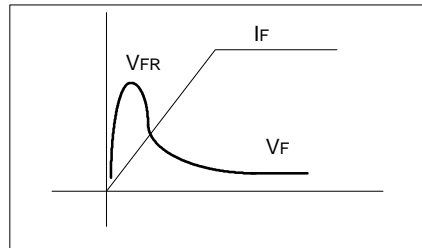
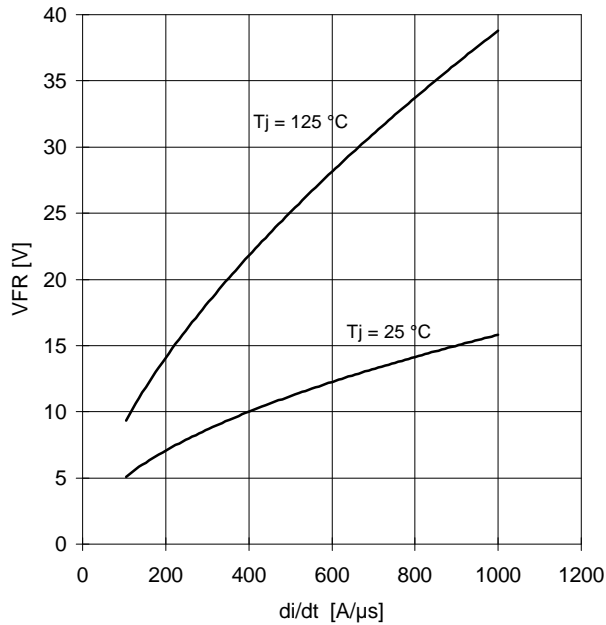

REVERSE RECOVERY CHARGE
Tj = 125 °C

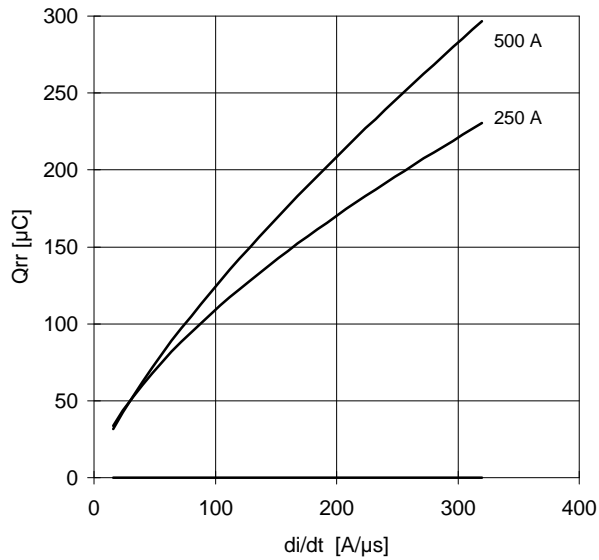

REVERSE RECOVERY CURRENT
Tj = 125 °C

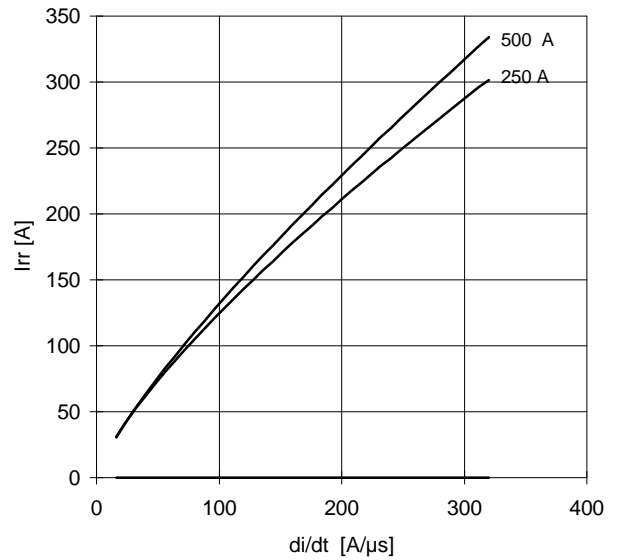

$$t_a = I_{rr} / (di/dt) \quad t_b = t_{rr} - t_a$$

$$\text{Softness (s factor)} \quad s = t_b / t_a$$

$$\text{Energy dissipation during recovery} \quad E_r = V_r \cdot (Q_{rr} - I_{rr} \cdot t_a / 2)$$

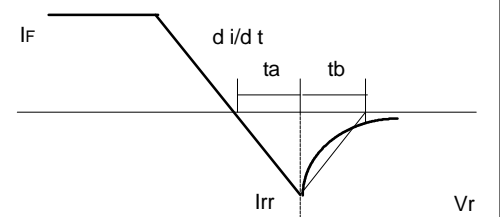

FORWARD CHARACTERISTIC
T_j = 125 °C

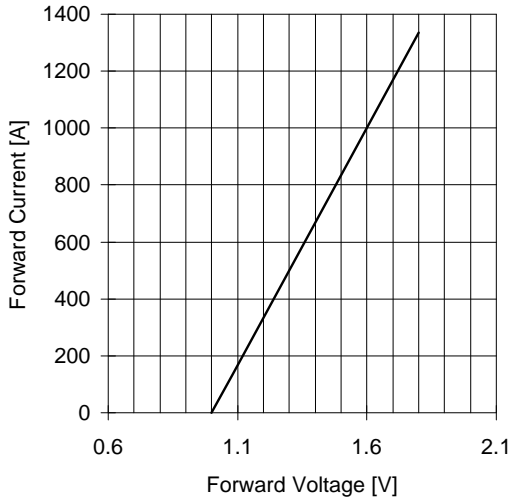

SURGE CHARACTERISTIC
T_j = 125 °C

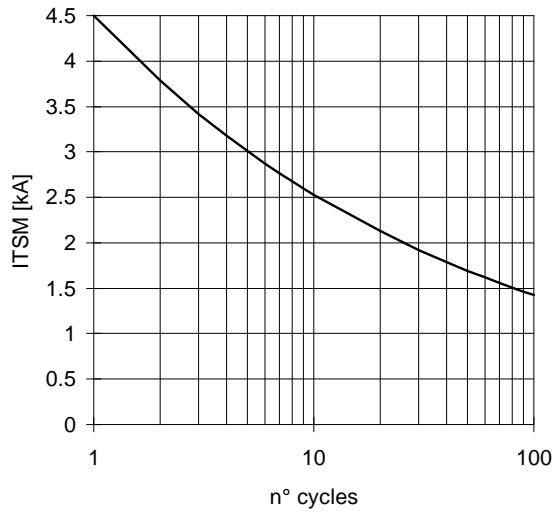

TRANSIENT THERMAL IMPEDANCE
DOUBLE SIDE COOLED

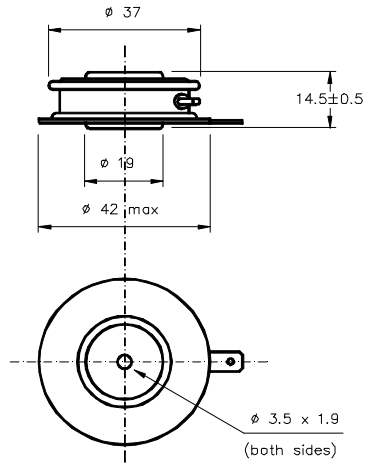
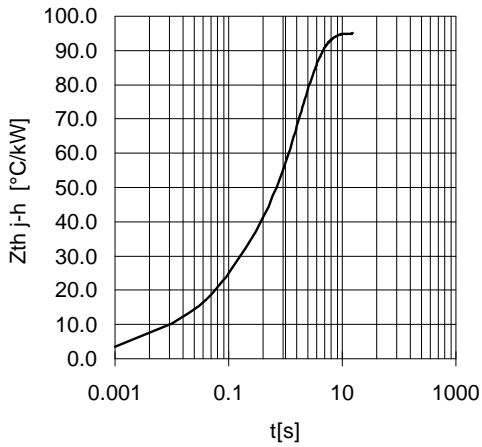

Dimensions in mm

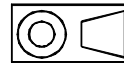

All the characteristics given in this data sheet are guaranteed only with uniform clamping force, cleaned and lubricated heatsink, surfaces with flatness < .03 mm and roughness < 2 μ m.

In the interest of product improvement ANSALDO reserves the right to change any data given in this data sheet at any time without previous notice.

If not stated otherwise the maximum value of ratings (symbols over

Distributed by

